

**TABLE OF CONTENTS**

Index by Description . . . . . A-E

Characteristics . . . . . 1-2

12-Step Finishing Process . . . . . 3

Policies . . . . . 4

Door Styles . . . . . 5-24

Premium Color Palette . . . . . 27

Unfinished . . . . . 28

Finish Techniques . . . . . 28

Finish Availability . . . . . 29-35

Construction Features . . . . . 36

Modification/Upgrade Compatibility Chart . . . . . 37

Construction Upgrades . . . . . 38

Drawer Front Options . . . . . 39-41

Drawer and Door Options . . . . . 42

Custom Modifications . . . . . 43-58

Door Modification/Specialty Doors . . . . . 59-63

Glass Inserts . . . . . 64-70

Cabinet Dimensions . . . . . 71-81

Design Checklist . . . . . 82

NKBA Guidelines . . . . . 83-84

Storage Solutions Reference Chart . . . . . 85-86

Wall Cabinets . . . . . 87-152

Hearths . . . . . 153-154

Base Cabinets . . . . . 155-218

Universal Access Cabinets . . . . . 219-221

Tall Cabinets . . . . . 222-257

Office & Furniture Cabinets . . . . . 258-272

Vanity Cabinets . . . . . 273-301

Fillers . . . . . 302-312

Panels & Skins . . . . . 313-324

Wainscoting . . . . . 325

Custom Panels, Doors, & Drawer Fronts . . . . . 326-329

Custom Hinged Doors . . . . . 330-331

Moulding . . . . . 332-344

Valances . . . . . 345

Embellishments . . . . . 346-358

Contemporary Embellishments . . . . . 359-360

Shelves . . . . . 360-362

Lighting & Lighting Accessories . . . . . 363-364

Hardware - Decorative Knobs, Pulls, Faux Hinges . . . . . 365-370

Accessories . . . . . 370-376

Roll Tray Kits . . . . . 377-379

Guide Kits and Parts . . . . . 380

Stain, Paint, & Touch-up Tools . . . . . 381

Hinges . . . . . 382

Doors, Drawer Fronts, & Drawers . . . . . 383

Parts . . . . . 383

Stacked Moulding Kits . . . . . 384-392

Agreements . . . . . 393-396

Index by Code . . . . . 397-398

Warranty . . . . . 399-401

Description	Code	Page Number
Abbe Foot . . . . .	ABFOOT . . . . .	352
Acanthus Moulding . . . . .	ACAM . . . . .	337
Add Toekick . . . . .	ADDTK . . . . .	54
All-plywood Construction . . . . .	APC . . . . .	38
Aluminium Frame Doors w/Frost Glass . . . . .	ALF . . . . .	59
Angled Corner Sink Front Bottoms . . . . .	ACSF . . . . .	180
Angled Corner Sink Fronts . . . . .	ACSF . . . . .	180
Angled Corner Sinks . . . . .	ACS . . . . .	179
Angled Fluted/Plain Fillers . . . . .	BLVDF . . . . .	307
Appliance Cut-out, Single . . . . .	ACS . . . . .	48
Arch Flat Panel Wood Hood . . . . .	WHAFP . . . . .	144
Arched Valance . . . . .	AV . . . . .	345
Art Corbel 9" . . . . .	CORBELART9 . . . . .	355
Arts & Crafts Bracket . . . . .	JBRACKETART . . . . .	356
Asymmetrical Base Easy Reach . . . . .	BER . . . . .	191
Asymmetrical Base Easy Reach w/Adjustable Shelves . . . . .	BERAS . . . . .	192
Asymmetrical Easy Reach Wall Corners . . . . .	ER . . . . .	129
Asymmetrical Solid-wood Super Lazy Susan . . . . .	SLSW . . . . .	194
Asymmetrical Super Lazy Susan w/Chrome Rail . . . . .	SLS . . . . .	195
Asymmetrical Super Susans . . . . .	SLS . . . . .	194
Authentic Ends . . . . .	AUTHB, AUTHL, AUTHR . . . . .	43
Back Panel Moulding . . . . .	BPM . . . . .	337
Back Skin, Interior . . . . .	BP . . . . .	314
Base Bin Tray Pull-out Cabinets . . . . .	BFTP . . . . .	207
Base Box Column Pull-outs (Plain, Overlay) . . . . .	BBCPO . . . . .	212
Base Buffet Three Drawer . . . . .	3DBB . . . . .	201
Base Buffet Three Drawer w/Deep Drawer . . . . .	3DBBDD . . . . .	203
Base Built-in Microwave Cabinet w/Drawer . . . . .	BBMWD . . . . .	215
Base Cabinets . . . . .	B . . . . .	155-156
Base Cabinets Four Drawer . . . . .	4DB . . . . .	204
Base Cabinets Four Drawer w/Wood Tiered Cutlery Divider Drawer . . . . .	4DB..WTCD . . . . .	204
Base Cabinets Full Width w/Roll Trays & Swing-outs . . . . .	BCFW..SP . . . . .	188
Base Cabinets Three Drawer . . . . .	3DB . . . . .	201
Base Cabinets Three Drawer Corner . . . . .	3CDB . . . . .	196
Base Cabinets Three Drawer w/Deep Drawer . . . . .	3DBDD . . . . .	203
Base Cabinets Three Drawer w/Warming Drawer . . . . .	3DB..WD . . . . .	203
Base Cabinets Three Drawer w/Wood Tiered Cutlery Divider Drawer . . . . .	3DB..WTCD . . . . .	202
Base Cabinets Two Drawer . . . . .	2DB . . . . .	199
Base Cabinets Two Drawer w/Drop-in Range . . . . .	2DB..DR . . . . .	200
Base Cabinets Two Drawer w/File Drawer . . . . .	2DB..FD . . . . .	199
Base Cabinets Two Drawer w/Pegged Dish Organizer . . . . .	2DB..PDO . . . . .	199
Base Cabinets Two Drawer w/Roll Tray . . . . .	2DB..RT . . . . .	200
Base Cabinets Two Drawer w/Roll Tray & Pegged Dish Organizer . . . . .	2DB..RTPDO . . . . .	200
Base Cabinets w/Full Height Doors . . . . .	B..FH . . . . .	158, 159
Base Cabinets w/Mixer Shelf . . . . .	B..FHMIXSC . . . . .	172
Base Container Organizer Pantry Pull-out . . . . .	BCOPP . . . . .	211
Base Corner Cabinets . . . . .	BC . . . . .	185
Base Corner Cabinets w/Pull-out . . . . .	BC..PO . . . . .	186
Base Corner Full Width Cabinets . . . . .	BCFW . . . . .	186
Base Corner Full Width Cabinets w/Curved Pull-out . . . . .	BCFW..CPO . . . . .	187
Base Corner Full Width Cabinets w/Pull-out . . . . .	BCFW..PO . . . . .	187
Base Corner Full Width, Full Height . . . . .	BCFW..FH . . . . .	187
Base Corner Inside . . . . .	B..CIA . . . . .	198
Base Corner Outside . . . . .	B..COA . . . . .	197
Base Corner Peninsula . . . . .	BCP . . . . .	217
Base Corner Peninsula, Full Height Door . . . . .	BCP..FH . . . . .	217
Base Drawer Cabinets . . . . .	DB . . . . .	199-204
Base Drop-in Range Cabinet . . . . .	B..DR . . . . .	213
Base Easy Reach . . . . .	BER . . . . .	190
Base Easy Reach w/Adjustable Shelves . . . . .	BERAS . . . . .	191
Base End Cabinet . . . . .	BEC . . . . .	198
Base End Shelves . . . . .	BQRES . . . . .	218
Base Full Height w/Tray Divider . . . . .	TD..FH . . . . .	172

Description	Code	Page Number
Base Lazy Susan Corner w/Center Hinge Door . . . . .	BLS . . . . .	189
Base Message Center . . . . .	BMC . . . . .	213
Base Microwave Cabinets . . . . .	BMW . . . . .	216
Base Microwave Cabinets w/Deep Drawer . . . . .	BMW..DD . . . . .	216
Base Microwave Cabinets w/Drawer . . . . .	BMW . . . . .	215
Base Mixer Kit . . . . .	MIXKITFHSC . . . . .	370
Base Open Cabinets . . . . .	BOC . . . . .	218
Base Ovens . . . . .	BO . . . . .	215
Base Pan Storage . . . . .	BPS . . . . .	370
Base Panel w/Filler Attached & Authentic End . . . . .	BEP.AEL, AER . . . . .	321
Base Pantry Pull-outs . . . . .	BPP . . . . .	210
Base Paper Towel Cabinet w/Wastebasket . . . . .	BPT..WB . . . . .	205
Base Paper Towel Cabinet w/Wastebasket Full Height . . . . .	BPT..WBFH . . . . .	207
Base Pots & Pans Pull-out . . . . .	BPPP . . . . .	168
Base Rotating Deep Bin . . . . .	BRDB . . . . .	195
Base Spice Drawer . . . . .	BSD . . . . .	209
Base Transition Cabinets . . . . .	BTC . . . . .	197
Base Tray Divider Pantry Pull-out . . . . .	BTDP . . . . .	210
Base Utensil Pantry Pull-out . . . . .	BUPP . . . . .	211
Base Utensil Pantry Pull-out w/Knife Block . . . . .	BUPPKB . . . . .	212
Base Wastebasket . . . . .	BWB . . . . .	205
Base Wastebasket Full Height . . . . .	BWB..FH . . . . .	206
Base Wastebasket Lids . . . . .	BWBFHLID, BWBLID . . . . .	370
Base Wine Cubby . . . . .	BWC . . . . .	209
Base w/Can and Wine Bottle Pull-outs . . . . .	B..CWP . . . . .	170
Base w/Food Storage Container Organizer . . . . .	B..FSCO . . . . .	169
Baseboard - Furniture . . . . .	BBMFB . . . . .	340
Baseboard Moulding . . . . .	BBM . . . . .	340
Baseboard - Sculpted . . . . .	BBMSC . . . . .	340
Baseboard - Shaker . . . . .	BBMSH . . . . .	340
Baseboard - Swooped . . . . .	BBMSW . . . . .	340
Bases w/Roll Trays . . . . .	B..RT . . . . .	165
Bases w/Roll-out Tray Divider . . . . .	B..TDRO . . . . .	171
Bases w/Tray Dividers . . . . .	TD . . . . .	171
Bases w/Wood Tiered Cutlery Divider Drawer . . . . .	B..WTCD . . . . .	157
Bases w/Wood Tiered Cutlery Divider Drawer & Roll Trays . . . . .	B..RTWTCD . . . . .	167
Batten . . . . .	BATTEN . . . . .	337
Bauhaus Corbel . . . . .	CORBELBAU . . . . .	357
Biometric Secured Drawer . . . . .	DRWSEC . . . . .	50
Bookcases Tall . . . . .	TBC . . . . .	262-263
Bookcases Tall w/Doors . . . . .	TBCD . . . . .	264-265
Bookcases Wall Furniture . . . . .	WFBC . . . . .	260
Box Column Fillers (Wall, Base, Tall) . . . . .	BCF . . . . .	307-312
Braided Moulding . . . . .	BRAIDM . . . . .	336
Broom Clip . . . . .	BRMCLP . . . . .	371
Buffet Leg . . . . .	JBUFFETLEG . . . . .	346
Bumper Pads . . . . .	BUMPERPADS . . . . .	383
Bungalow Leg . . . . .	BUNLEG . . . . .	346
Cabinet Box Only . . . . .	CBO . . . . .	45
Cabinet Care Kit (PURE&SIMPLE™) . . . . .	CABCLEANKIT . . . . .	381
Cabinet Case Only . . . . .	CCO . . . . .	45
Cabinet False Panel . . . . .	CFP . . . . .	45
Cabinet Frame Only . . . . .	CFRMO . . . . .	58
Cabinet Front Only . . . . .	CFNTO . . . . .	58
Cabinet Panel Edge Moulding . . . . .	CPE . . . . .	337
Cabinet Panel Edge Square Moulding . . . . .	CPES . . . . .	341
Cabinet w/No Door, w/Drawer . . . . .	CND . . . . .	45
CabMat™ . . . . .	CABMAT . . . . .	371
CabMat™ . . . . .	CMAT . . . . .	50
CabMat™ Vanity . . . . .	CABMATV . . . . .	371
Canopy Arch Wood Hood . . . . .	JWHCA, WHCA . . . . .	148
Canopy Square Wood Hood . . . . .	JWHCS, WHCS . . . . .	149
Cap Moulding . . . . .	CAPM . . . . .	341
Celtic Insert . . . . .	INSERTCELT . . . . .	336

Description	Code	Page Number
Classic Arch Wood Hood	WHA	143
Classic Revival Corbel	CORBELCR	355
Classic Square Wood Hood	WHS	144
Classic Tall Crown Moulding	CLTCROWN	332
Classic Wood Hood Chimney	WHC	145
Contemporary Light Rail	JINSERTLRC	343
Cooking Utensil Divider	CUDD	371
Corner Door Cabinets	CD	136
Corner Fillers	CF	302
Cornice Tall Crown Moulding	COTCROWN	332
Cosmo Corbel, 13" Large Deep	JCORBELCOS13D	355
Cosmo Foot	JCOSFOOT	352
Cosmo Leg	JCOSMOLEG	347
Countertop Edge Moulding (Contemporary & Traditional)	CCM, TCM	337
Country Sink Base w/CabMat™	CNTYSB..CM	181
Country Sink Base w/Short Apron	CNTYSB..SA	183
Country Sink Bases	CNTYSB	181
Cove Corbel	CORBELCOVE	355
Cove Crown Moulding	COVECROWN	332
Craftsman Foot	JCRAFTFOOT	352
Craftsman Open Bracket	JCORBELCRAFTO	356
Cross Grain Veneer Back Skin 1/4" Panels	BP..CRSGR	315
Custom Doors, No Hinge Routing	DADOOR	327
Custom Doors w/Hinge Routing	DOOR	330
Custom Doors w/Hinge Routing, Slab Styles	DOORSLAB	331
Custom Drawer Fronts	DASPCDF, DASLBDF	328
Cut-for-glass Doors	CG, CG.BTM, CG.TOP	60
Cutlery Dividers	CIW, WTCD	371
Decorative Appliance Panels	DAPNL	326
Decorative Door Panel Kits, Base End	BED	323
Decorative Door Panel Kits, Tall End	TED	323
Decorative Door Panel Kits, Wall End	WED	324
Decorative Split Turning End	SPTRINGEND	354
Decorative Split Turning Spool	SPTRINGSPPOOL	354
Deep Roll Tray	DRT	51
Dentil Moulding	MDENTIL	336
Desk Door Drawer Bases	DDO	266
Desk Double File Drawer Bases	DDFD	268
Desk Easy Reach	DER	269
Desk File Drawer Bases	DFD	267
Desk Three Drawer Bases	SDB	267
Desk Wastebasket Full Height Bases	DWB..FH	268
Diagonal Base Cabinet w/Full Height Door	DAB..FS	189
Diagonal Base Cabinet w/Full Height Door & Super Lazy Susan	DAB..SLS	190
Diagonal Corner Moulding	DCM	343
Diagonal Wall Cabinets	DW	122-123
Diagonal Wall Cabinets w/Lazy Susan	DW..S	124
Diagonal Wall Cabinets w/Lower Door	DW..D	124
Diagonal Wall Cabinets w/Lower Door & Lazy Susan	DW..DS	125
Diagonal Wall Peninsula Cabinets	DW..P	127
Door Panel - Solid Reverse Raised	DPSRR	42
Drawer Front Flat 5-piece	DFF5PC	39
Drawer Front Flat 5-piece Narrow Rails	DFF5PCNR	39
Drawer Front Flat 5-piece Narrow Rails w/Slab Top	DFF5PCNRST	40
Drawer Front Flat 5-piece w/Slab Top	DFF5PCSLBT	40
Drawer Front Raised 5-piece	DFR5PC	39
Drawer Front Raised 5-piece w/Slab Top	DFR5PCSLBT	41
Drawer Front Slab	DFSLB	39
Drawer Front Slab Top	DFSLBT	41
Drawer Guide Back Sockets	BKSOCKET	380
Drawer Guide Box Locks	DGBOXLOCK	380
Drawer Guide Kits	DGK	380
Drawer Guide Spacer Block	SPACERBLK	380
Ductwork Conversion Kit	CONVERSION	152
Easy Reach Wall Corner Cabinets	ER	128

Description	Code	Page Number
EasyTrax™	ET	51
Edgebanding	EDGEBAND	372
Egg & Dart Moulding	EGD	336
End Extended Back	EXBKL, EXBKR	47
End Panel/Base	BEP	316
End Panel/Base Lazy Susan	BLSBEP	317
End Panel/Tall	TEP	317
End Panel/Vanity Base	VBEP	318
End Panel Skins/Base	BEPS	313
End Panel Skins/Tall	TEPS	313
End Panel Skins/Wall	WEPS	314
English Bar Column	ENGBARCOLUMN	347
English Country Leg	JENGCONTYLEG	347
English Island Column	ENGISLCOLUMN	347
Estate Leg	JESTATELEG	348
Estate Leg, Small	JESTATELEGS	347
Estate Leg Split, Small	JESTATELEGSS	347
Extended Stile	EXL, EXR	48
Exterior Shelves	ES	361
EZ-Orig™ Modular Pull-out Racks	EZORG	374
Face Frame and Door on End	FFDL, FFDR	43
False Panel Clips	FALSEPNLCLIP50, PFALSEPNLCLIP50	380
Filler Return	F..R	302
Fillers	F, TF	302
Finished Back Skins	BP	314
Finished Ends	FB	43
Flat Scribe Moulding	SM	337
Floating Shelves	FS	360
Floating Shelves, Stainless Steel	SSFSH	360
Flush Toekick	FTK, FTK.FNT.P, FTK.P	54
Flush Toekick Arch	FTKAV, FTKAV.FNT.P, FTKAV.P	54
Flush Toekick Furniture	FTKFV, FTKFV.FNT.P, FTKFV.P	54
Fluted/Beaded Fillers	FBF	307
French Country Leg	JFRNCNTYLEG	348
Full Depth Interior Shelves	SK	362
Full Depth Shelf	FD	50
Full Height Rangetop Base	RTBFH	214
Full Overlay Crown	FOLCROWN	332
Furniture Base Light Rail	FBLR	341
Furniture Drawer Window Bench	FDWB	270
Furniture Drawers	FD	269
Furniture Finished Plywood Ends	FPPEB	43
Furniture Valance	FV	345
Gaelic Leg	GAELICLEG	348
Glass Shelf Kits	JGSK	362
Hardware - Decorative Knobs, Pulls, Faux Hinges	HINGEFH, KNOB, PULL	365-370
Hearth Liner	HL	154
Hearth Mantels	HM	154
Hearth Piers	HP..21	154
Hearth Shelf	HS	154
Heat Shields, Angled	ANGLHEATSHIELD, ANGLHSHIELDSS	372
Heat Shields, Straight	STRTHEATSHIELD, STRTHSHIELDSS	373
Hinge Angle Restriction Clip	HINGERESCLIP	382
Hinge Shim	HINGESHIM	382
Hinges	HINGE	382
Increased Depth	ID	46
Industrial Bracket, Loop	BRACKETIND	359
Industrial Bracket, Straight	STBRACKETIND	360
Insert Crown	INSCROWN	333
Inside Corner Moulding	ICM	343
Installed Roll Tray	RT	51

Description	Code	Page Number
Inverted Frame	INVFRM	49
Island Leg	ISLLEG	348
Island Leg Tapered	ISLEGTPRD	349
K-Cup Insert	WBCPOKCUP	373
Kensington Bun Foot	JCRBUNFOOT	352
Large Corbel	LGCORBEL	355
Large Outside Corner Moulding	LOSC	343
Large Shaker Crown	LSHAKER	334
Large Square Foot	LGSQFOOT	353
Large Straight Angle Crown Moulding	LSACROWN	333
Lazy Susan Pull-out	LSP	196
Library Moulding	LBRM	338
Lid Organizers	LO	373
Lidstay	LIDSTAY, LIDSTAYHD	382
Light Baffle Moulding	LB	342
Light Installed Battery Strip	LTI	51
Light Rail Cap	SOFFITA	342
Light Rail Cap - Shaker	SOFFITE	342
Light Rail Moulding	LRM	342
Lighting & Lighting Accessories	—	363-364
Lille Foot	LIFOOT	353
Linear Tapered Wood Hood	JWHL	145
Linen Closet	LC	295
Linen Closet Hamper Liner	LCHAMPERLNR	373
Linen Closet w/Removable Hamper	LCRH	295
Linen Tall	LT	295
Linen Tall w/Drawer	LTD	296
Linen Tall w/Drawer and Removable Hamper	L	296
Loose Toekick	TKP	56
Madeline Foot	JMADEFOOT	353
Matching Interior Plywood	MIP	44
Medicine Cabinets (Single & Tri-View)	MC, TV	301
Medium Straight Angle Crown Moulding	MSACROWN	333
Metal Feet	FOOTMETAL	359
Metro Bar Column	METBARCOLUMN	349
Metro Island Column	METISLCOLUMN	349
Metropolitan Foot	JMETROFOOT	353
Mid-century Triangle Bracket	TRIBRKT	359
Mirror Frame Moulding	WMF	338
Miscellaneous Parts	BRKOFFSCREW, BUMPERPADS, INSTALLSCR, INSTALLSCREWS, PDM, RETCLIP.BAG, SHELFPEGS, SHELFPEGSCTR	383
Mission Corbel 6"	CORBELMIS6	356
Mission Corbel 9"	CORBELMIS9	356
Mission Leg	DLEGMISSION	349
Mission Rosette	ROSETTEMIS	346
Modern Corner Floating Shelf	MDFLCRNSHLF	361
Modern Corner Shelf	MDCCRNNSHLF	360
Modified Full Overlay	MFO	42
Mullion Doors	MD, MD.BTM, MD.TOP	61
Mullion Doors, Prairie	PRMD	63
Mullion Doors, Shaker	SHMD	62
Ogee Edge Moulding	OGEEM	338
Old World Corbel 5"	CORBELOWD5	356
Outside Corner 135° Moulding	OC135	344
Outside Corner Moulding	OCM	343
Oven Cabinets Double	OCD	245-246
Oven Cabinets Double w/Drawer	OCD..DD, WD	247-249
Oven Cabinets Double w/Drawer & Extended Opening	OCD..WDE	250
Oven Cabinets Single	OSB	238-239
Oven Installation Kit	OCINSTALLKIT	373
Oven Microwave Cabinets	OMC	253-254

Description	Code	Page Number
Oven Microwave Cabinets w/Drawer	OMC..DD, WD	255-257
Oven Microwave Combo Cabinets	OCS	240-241
Oven Microwave Combo Cabinets w/Drawer	OCS..DD, WD	242-244
Overlay Fillers	OL	303
Overlay Fillers for Modified Full Overlay	OL..MFO	303
Panels w/Filler Attached	BEPF, TEP, WEP	319-322
Pantry Top Units	PTU	234
Pantry Top Units w/Shelves	PTUS	233
Pantry Units	PY	236
Pantry Walk-Through	PWT	237
Pegged Dish Organizer	PDO, PDOPOSTS	373
Peninsula	P	58
Plinth Block	PLBLOCK	354
Plinth Block Filler 3"	FFP	346
Plywood Ends	PE	38
Pots & Pans Organizer Bases w/Drawer	B..PS	168
Pots & Pans Pull-out	PPP	373
Power Pods	JPWRPOD	374
PowerGlide™ Compact Drawer Outlet	DRWPWR	52, 374
Prepare Cabinet for Finished Bottom	PFINBTMB	47
Push to Open Wastebasket	PTOWB	52
Quarter Round Moulding	QRM	344
Quattro Dimming Receiver	QDIMREC	364
Quattro Wall Controller	Q4ZONECON	364
Raised Panel Arch Valance	JRPV	345
Recessed Island Toekick	RECTKALL	56
Recessed Panel Arch Valance	JRCPV	345
Recessed Toekick on Back or Side	RECTKBK, RECTKL, RECTKR	56
Reduced Depth	RD	46
Removable Vanity Sink Base	RVWS	221
Roll Tray Kits	RT	377
Roll Tray Kits Deep	DRT	377
Roll Tray Plug In Bracket	RTBKXSP	380
Rope Moulding	RPM	336
Scooped Drawer	SCPDRW	42
Shaker Corbels	JCORBELSHKR	357
Shaker Crown Moulding	SHKRCRM	333
Shelf Pull-down	SHLFPD	374
Shelf Support Bracket	SHELFBRKTSN	360
Shiplap Straight Wood Hood	JWHSHIPSTR	145
Shiplap Straight Wood Hood w/Corbels	JWHSHIPSTRCB	146
Shiplap Tapered Wood Hood	JWHSHIPT	146
Shiplap Tapered Wood Hood w/Corbels	JWHSHIPTCB	146
Shiplap Wood Hood Chimney	JWHSHIPCH	146
Shoe Moulding — Convex Inside Corner	SHM	344
Simple Tapered Wood Hood	WHSMT	147
Simple Tapered Wood Hood w/Corbels	WHSMTCB	147
Simple Wood Hood Chimney	WHSMC	148
Single Bead Edge Moulding	SBE	338
Single Bead Moulding	SBM	338
Single Bead Plaster	SBP	338
Single Door Medicine Cabinet	MC	301
Single Outlet Cover	JSOC	358
Single Rocker Plate	JSRC	358
Sink Base Corner	SBC	184
Sink Base SuperCabinet™	SB..S	177
Sink Base SuperCabinet™ w/CabMat™	SB..SCM	177
Sink Base SuperCabinet™ w/Tilt-out Trays	SB..STS	177
Sink Base SuperCabinet™ w/Tilt-out Trays & CabMat™	SB..STSCM	178
Sink Base w/CabMat™	SB..CM	173
Sink Base w/Tilt-out Trays & CabMat™	SB..STCM	176
Sink Bases	SB	173-175
Sink Bases w/Drawers Below	SB..D	178
Sink Bases w/Tilt-out Trays	SB..ST, SB..CSST	175, 176
Sink Front Bottoms	SFB	179

Description	Code	Page Number
Sliding Towel Rack	STR	374
Small Corbel	SMCORBEL	355
Small Cove Crown Moulding	SMCOVECROWN	334
Small Crown Moulding	SCM	334
Small Light Rail Moulding	SMLR	342
Small Scribe Moulding	SCRIBE	338
Snack Bar Support 11 1/4"	SBS	356
Soffit Filler Moulding	SFM	335
Soffit Trim Moulding	TSTM	339
Solid-wood Crown Moulding	SWCRM	334
Solid-wood Large Crown Moulding	SWLCRM	335
Solid-wood Super Lazy Susan	SLSW	193
Solid-wood Tall Crown Moulding	SWTCRM	335
Solid-wood Victorian Crown Moulding	SWVCRM	335
Space Fillers	S96	303
Spice Rack Pull-down	SPD	374
Spice Racks	SRCH	374
Spool Leg	SPLEG	349
Spool Leg Split, Small	JSPLEGSS	349
Square Bar Leg	JSQBARLEG	350
Square Corner Sinks	CS	179
Square Flat Panel Wood Hood	WHSFP	144
Square Foot	JSQFOOT	353
Square Foot, Split	JSQFOOTS	353
Square Island Leg	JSQISLLEG	350
Square Island Leg, Metal Sleeve	SQLEG	351
Square Leg w/Tapered Foot	SQLEGTAP	351
Stacked Diagonal Wall Cabinets	STDW	126
Stacked Wall Cabinets	STW	114-116
Stacked Wall Corner Cabinets	STWC	120
Stain & Paint	QUARTCOLOR, SSC	381
Starter Moulding	STR8	335
Starter Moulding, Shaker	STRS	336
Straight Angle Crown Moulding	SACROWN	333
Straight Batten Wood Hood	WHSBATTEN	149
Straight Valance	VV	345
Super Lazy Susans w/Chrome Rail	SLSCR	193
Super Susans	SLS	192
SuperCabinet™, 30"	BSC30PR, R, RP, RS, SR	161
SuperCabinet™, 36"	BSC36PRP, PRS, SRP, SRS	163
SuperCabinet™ Version 2, 30"	BV2SC30PR, RP, RS, SR	162
SuperCabinet™ Version 2, 36"	BV2SC36PRP, PRS, SRP, SRS	164
Tall Built-in Microwave Cabinet	TBMWB	251
Tall Crown Moulding	MTCROWN	333
Tall Panel w/Filler Attached & Authentic End	TEP.AEL, AER	322
Tall Pantry Pull-outs	TPP	235
Tapered Leg	TAPLG	354
Tapered Wood Hoods	TWH	150
Tilt-out Trays, Plastic	TOT	375
Tilt-out Trays, Stainless Steel Slim	TOTSSS	52, 375
Toeboards	TB	341
Toekick Cap	TKC	341
Toekick Drawer	DRWTK	57
Toekick Vacuum	TOEKICKVAC	375
Toekick Tulip Foot	TKTLFOOT	354
Touch Latch	TOUCHLATCH	359
Touch-up Tools	GLAZEPEN, MTUK, TUK	381
Traditional Light Rail	JINSERTLRT	342
Tray Divider, Chrome	CTDK	375
Tray Divider Kit	TDKIT	375
Tray Divider Roll-out Kit	TDRO	376
Tray Dividers	TD	53
Triad Corbel	CORBELTRIAD	357
Triple Bead Edge Moulding	TBEM	339

Description	Code	Page Number
Triple Bead Pilaster Moulding	TBP	339
Tri-View Medicine Cabinets	TV	301
Tulip Foot	TLFOOT	354
Turned Post Island Leg	TURNEDPOST	351
Under Counter Drawers	UCD	272, 294
Under Counter Drawers Trimmable	UCDT	272, 294
Under Panel Moulding	UPM	339
Universal Access Base Cabinets	B	219
Universal Access Base Microwave w/Deep Drawer	BMWD..DD	220
Universal Access Desk Leg	VDL..WD	221
Universal Access Sink Base Cabinets	SB	219
Universal Access Sink Base Cabinets w/Tilt-out Trays	SB..ST	220
Universal Access Super Lazy Susan	SLS	220
Universal Access Three Drawer Base Cabinets	3DB	220
Urn Leg	JURNLEG	352
Utility Cabinets	U	222-227
Utility Cabinets w/Roll Trays	U..RT	228-230
Utility Organizer Cabinets	UOC	231
Utility Organizer Drop Zone Cabinet	UOCDZ	232
Valance Top Rail	TVRAV, TVRFV, TVRVV	49
Valley Forge Moulding	VFR	342
Vanity Base Easy Reach	VER	280
Vanity Base Wastebasket	VBWB	281
Vanity Bases	V	273-274
Vanity Chrome Roll-out Rack	VCRR	376
Vanity Desk Legs	VDL	322
Vanity Door Drawer Bases	VB	278
Vanity Drawer Bases	VDB	280
Vanity Four Drawer Bases	4VDB	281
Vanity Grooming Pull-out	VGPO	283
Vanity Hamper	VH..FH	294
Vanity Hamper w/Drawer	VBH	294
Vanity Mirror	VM	301
Vanity Mirror w/Side Pull-outs	VMP	300
Vanity Pull-out	VP	283
Vanity Sink Bases w/False Drawer Fronts	VSB	275-276
Vanity Sink Bases w/U-shaped Pull-out Trays	VSB.....U	277
Vanity Sink Bases w/Wastebasket	VSB.....WB	277
Vanity Sink Bases SuperCabinet™ w/Tilt-out Trays	VSSB.....ST	278
Vanity Sink Bases SuperCabinet™ w/Tilt-out Trays & Wastebasket	VSSB.....STWB	277
Vanity Sink Drawer Bases	VSD	284-289
Vanity Sink Drawer Bases w/Eight Drawers	VSD	293
Vanity Sink Drawer Bases w/Eight Drawers & False Panel	VSD..FP	293
Vanity Sink Drawer Bases w/Six Drawers	VSD	292
Vanity Sink Drawer Bases w/Six Drawers & False Panel	VSD..FP	292
Vanity Sink Three Drawer Bases	VSDS	290
Vanity Sink Wide Drawer Base w/False Panels	VSWD..FP	290
Vanity Utility Cabinets	VU	296
Vanity Wall Cabinets	W	299
Vanity Wall Cubby	VWC	299
Vanity Wall Hung Cabinets	VWH	297
Vanity Wall Mirror Cabinets	VWM	299
Vanity Wall Sink	VWS	221
Vanity Wastebasket	VWB	282
Void Toekick	VTK	57
Wainscoting	WAIN	325
Wall Appliance Garage Door	WAGD	135
Wall Appliance Garage Vertical-lift Door	WAGVLD	136
Wall Base Double Door Cabinets	WB	160
Wall Base Single Door Cabinets	WB	160
Wall Box Column Pull-outs (Plain, Overlay)	WBCPO	137
Wall Built-in Microwave Cabinets	WBMW	134
Wall Corner Cabinets	WC	117-119
Wall Corner Inside	W..CIA	129

Description	Code	Page Number
Wall Double Door Cabinets . . . . .	W	89-110
Wall Easy Access Storage Cabinets . . . . .	WEAS	110
Wall End Cabinets . . . . .	WEC	130
Wall Message Center . . . . .	WMC	143
Wall Microwave Cabinets . . . . .	MW	134
Wall Organizers . . . . .	WO	142
Wall Quarter Round End Shelves . . . . .	WQRES	131-133
Wall Refrigerator Cabinets . . . . .	W	90
Wall Refrigerator Pull-out . . . . .	W..PO	98, 102, 104
Wall Refrigerator Vertical-lift . . . . .	WVL	97, 101
Wall Shelf Pull-down . . . . .	W..SHLFPD	139
Wall Single Door Cabinets . . . . .	W	88-109
Wall Spice Drawers . . . . .	WSD	142
Wall Spice Pull-out . . . . .	WSP	139
Wall Spice Rack Cabinets . . . . .	WSR	140
Wall Susan Kits . . . . .	WSK	376
Wall Three Drawer Cabinets . . . . .	W3D	113
Wall Top Hinge Angle Restriction Clips . . . . .	WTHRESCLIP	382
Wall Top Hinge Cabinets . . . . .	WTH	87-101
Wall Two Drawer Cabinet . . . . .	W2D	111, 112
Wall Vertical-lift . . . . .	WVL	96-101
Wall Wine Cubbies . . . . .	W	141
Wall Wine Racks . . . . .	WNR	140
White Laminate Interior . . . . .	WLI	44
Wide Scribe . . . . .	WSCRIBE	339
Window Casing — Traditional . . . . .	WCT	344
Wine Glass Holders . . . . .	WGH	376
Wine Storage Cabinet . . . . .	WSC	141
Wood Hood Blowers . . . . .	BLOWER	151
Wood Tiered K-Cup Drawer . . . . .	KCUP	372
Wood Tops, Four Sided . . . . .	4TWT	272
Wood Tops, One Sided . . . . .	1TWT	270
Wood Tops, Three Sided . . . . .	3TWT	271
Wood V-grooved Beaded Skin 1/4" Panels . . . . .	BP..VG	315
Wood V-grooved w/Triple Beaded Front 3/4" Panels (Base, Tall, Wall) . . . . .	BEP, TEP, WEP..VG	322

## CHARACTERISTICS OF WOOD TYPES

No matter which species you choose for your new kitchen or bath cabinetry, please keep in mind that no two pieces of wood are exactly the same. Stains are likely to exaggerate the difference between open and closed grains and other markings in wood. Grain variation and color change should be expected. As hardwood ages, it will darken when exposed to different types of light. Color differences or changes in wood can also be caused by exposure to harsh chemicals, extreme heat or moisture. Additionally, wood species exhibit other defining characteristics, such as mineral deposits/streaks, knots, sap runs, pin holes and wormholes. These markings make the wood unique and contribute to its enduring beauty.

**Alder** has a straight fine textured grain similar to Cherry and Maple. Although classified as a hardwood, it is moderately light in weight and considerably softer than other species. Therefore, care must be taken as it will dent and mar easily. Alder may exhibit grain and color variations, sapwood can be distinguishable from the heartwood, tight pin knots are sometimes present.

**Cherry** is characterized by its red undertones, but may vary in color from white to a deep, rich brown. Cherry is a close-grained wood with fairly uniform texture, revealing pin knots and curly graining. All wood will age with time and the finish will darken. This is especially true for Cherry. This is a sought-after quality in Cherry cabinetry, and those who select it expect this evolution.

**Maple** is a close-grained hardwood that is predominately white to creamy-white in color, with occasional reddish-brown tones. While Maple typically features uniform graining as compared to other wood species, characteristic markings may include fine brown lines, wavy or curly graining, bird pecks and mineral streaks. These traits are natural and serve to enhance Maple's natural beauty.

**Oak** is a strong, open-grained hardwood that ranges in color from white to pink and reddish tones. Streaks of green, yellow and even black may appear due to mineral deposits. Oak may also contain wormholes and wild, varying grain patterns. This distinct graining is considered a desirable quality.

## CHARACTERISTICS OF RUSTIC WOOD TYPES

**Rustic Alder** is characterized by its light brown and reddish undertones and may contain a variety of pin holes, open and closed knots of various sizes and colors, small cracks, bird pecks, mineral streaks, and grain variation. Some knots may have small holes through the panel. Larger holes will not be filled. In addition, the wood will contain color difference caused by variations in minerals found in the soil, creating visible mineral tracks.

**Rustic Hickory** is a strong, heavy hardwood known for distinctive graining patterns. Color will vary from nearly white to dark brown, with wild flowing grain patterns and dramatic color variations. Rustic Hickory can have a fine uniform grain to large knots appearing black and brown in color of various shapes and sizes, sapwood, mineral and some checking. Doors, drawer fronts, and selected trim items will feature rustic characteristics. Other areas of the product will utilize standard Hickory.

**Sound Closed Knot** (not moveable) – Expected up to approximately 3" in diameter

**Sound Knot with Cracks** – Expect sound knots with open cracks up to approximately 1" in length

**Open Knot** (through door) – Expected with open area up to approximately 3/4" in diameter

Note: 3/4" diameter is about the size of a penny. Holes created by open knots pass completely through the door and are desirable for this rustic look.

**Unsound Knot** (moveable core) – Not to be expected

**Knot Cluster** (cluster of tight sound knots) – To be expected (more prevalent in Rustic Alder)

**Worm Holes/Pin Holes** (can go through the door) – Can be expected up to approximately 1/4" in diameter

**Worm Tracks** – Can be expected in sizes up to approximately 1/8" wide by 8" long

## CHARACTERISTICS OF MDF

MDF (Medium Density Fiberboard) is an engineered wood product that is composed of wood fibers and resin that are then compressed to create a smooth uniform surface with a consistent core. Painted MDF eliminates the appearance of naturally occurring wood characteristics such as grain patterns, knots or mineral streaks, and is more resistant to warping, expanding and contracting due to environmental changes than solid hardwoods.

## CHARACTERISTICS OF GLAZING/PAINT

### Flooded Glazes

A professional layer of glaze can add another layer of beauty to your cabinets. First, our craftsmen apply a wood toner, which accentuates the grain's natural attributes. We then add the glaze, by hand, adding depth, dimension and an understated sheen that's guaranteed to endure.

- Glazing will range from a consistent, even appearance to varied coverage.
- You should expect the result to yield a subtle to dramatic look based on the complexity of a cabinet door's design, as glaze may collect in the corners and grooves.
- Printed materials and online, electronic presentations can only do so much. It's important to both see and touch actual finished samples to ensure your satisfaction.

### Paint Finish

Paint may develop hairline cracks in the finish, most notable around the joints. This is a result of natural expansion and contraction of the genuine hardwoods used in the manufacturing of this product. Hairline cracks are not considered a defect in the cabinetry or finish.

## CHARACTERISTICS OF SPECIALTY LAMINATE

**Specialty Laminate** features design leading, high definition wood grain or high gloss laminates on doors, drawer fronts, overlay fillers, and Premium trim items. The surfaces are laminate based materials with an integrated top coat that provides superior beauty, durability, and performance while meeting or exceeding all of the KCMA performance standards. The core panel material is made of MDF to ensure a consistent and stable product.

Additional coordinating trim items in the cabinet box color are also available. Grain characteristics will vary across laminated parts to mimic natural wood grain patterns. A heat shield is required to separate all laminate products from heat producing units to be in compliance with cabinet warranty.

## CHARACTERISTICS OF DECORATIVE LAMINATE

**Decorative Laminate** is the process of wrapping durable laminate materials around door frames and select trim and premium mouldings resulting in products with crisp styling features and a surface that provides abrasion resistance and meets/exceeds all of the KCMA performance standards. Decorative Laminate products are wrapped (versus form pressed onto a Medium Density Fiberboard (MDF) slab like thermofoil) and have a clear, integrated top coat for superior durability. The lineals and core panel material are made of MDF to ensure a consistent and stable product.

These doors offer the durability of a laminate and the beauty of paint and finished wood while bringing peace of mind to those who care about creating a better environment—both inside and outside of their homes.

Textured wood grain Decorative Laminate doors feature design leading, high definition wood grain laminates on doors, drawer fronts, overlay fillers, and Premium trim items. The surfaces are laminate based materials with an integrated top coat that provides superior beauty, durability, and performance while meeting or exceeding all of the KCMA performance standards. The core panel material is made of MDF to ensure a consistent and stable product. Additional coordinating trim items in the cabinet box color are also available.

A heat shield is required to separate all Decorative Laminate products from heat producing units to be in compliance with cabinet warranty.

In keeping with our practice of continuous product improvement and/or to maximize efficiencies, MasterBrand Cabinets may adjust specifications in design and materials as it deems necessary. Where differing materials are utilized, they will be of similar or better quality in keeping with MasterBrand Cabinets' commitment to quality.



## 12-STEP FINISHING PROCESS

- 1. Wood Selection** – The selection of the finest woods is the essential first step of the 12-step finishing process.
- 2. Sanded to Perfection** – Our sanding utilizes a fine grit paper, both with and against the wood grain. This process is completed on a vacuum table, allowing for a wood surface that is free of dust particles.
- 3. Achieving Natural Wood Tone** – Toner is applied to selected finishes, enhancing the naturalistic wood appearance.
- 4. Stain Application** – A hand-sprayed deep penetrating stain is evenly applied to all surfaces for even coverage on all profiles. On multi-step stains and glaze finishes, some non-facing surfaces (such as backs of doors, backs of panels, and matching veneer interiors) may not receive all steps noted. The resulting finish will be complementary and similar in color and have the same catalyzed top coat and cure, but may not result in the same color depth as facing surfaces.
- 5. Removal of Excess Stain** – The wood is hand-wiped to remove excess stain, emphasizing the cabinet's natural wood grain.
- 6. Catalyzed Sealer** – A tough, clear, catalyzed sealer is hand-sprayed on to protect the grain from moisture.
- 7. Drying Process** – For added durability, the sealed wood is oven cured to lock in the beauty of wood.
- 8. Hand-Sanded** – To achieve an ultra-smooth finish, we hand-sand the material one last time.
- 9. Dust Removal** – The resulting loose dust particles are removed from the surface of the wood.
- 10. Catalyzed Top Coat** – A premium quality catalyzed clear top coat is applied to protect the wood from environmental elements.
- 11. Final Top Coat Cure** – The top coat is cured to guarantee the strongest, most beautiful finish.
- 12. Final Inspection** – This last inspection is very thorough, ensuring quality and beauty. Our gift to you is that every cabinet is crafted with care.

# POLICIES

## **Humidification**

<https://www.masterbrand.com/humidification>

## **Installation Instructions**

<https://www.masterbrand.com/installation>



## **Care and Cleaning**

<https://www.masterbrand.com/care-and-cleaning>

4

POLICIES

## Door Style Reference Chart

	Alder	Cherry	Maple	MDF	Oak	Rustic Alder	Rustic Hickory	Decorative Laminate	Specialty Laminate
Door 15	✓	✓	✓	✓	✓	✓	✓		
Door 16		✓	✓						
Door 17		✓	✓		✓		✓		
Door 18	✓	✓	✓	✓	✓	✓	✓		
Door 19		✓	✓	✓					
Door 21		✓	✓		✓				
Door 22		✓	✓						
Door 23 		✓	✓						
Door 24 		✓	✓		✓				
Door 25									✓
Door 26		✓	✓						
Door 28		✓	✓				✓		
Door 29		✓	✓						
Door 31	✓					✓	✓		
Door 32		✓	✓	✓					
Door 33									✓
Door 34		✓	✓						
Door 35	✓	✓	✓						
Door 36									✓
Door 37								✓	
Door 38	✓	✓	✓		✓	✓	✓		
Door 39		✓	✓						
Door 41		✓	✓						
Door 42	✓	✓	✓			✓	✓		
Door 43		✓	✓						
Door 44		✓	✓						
Door 45		✓	✓						
Door 46		✓	✓						
Door 47 	✓	✓	✓			✓			

# FULL OVERLAY DOOR STYLES

6

DOOR STYLES

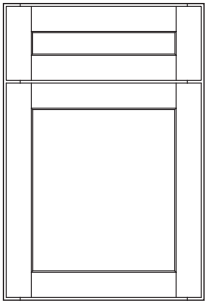

Door 15  
(page 10)

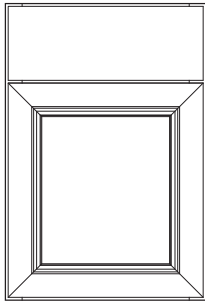

Door 16  
(page 10)

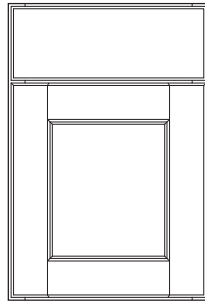

Door 17  
(page 11)

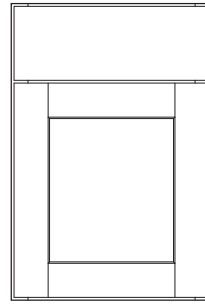

Door 18  
(page 11)

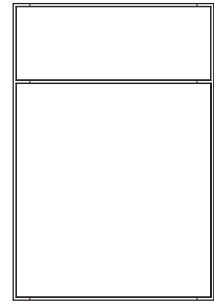

Door 19  
(page 12)

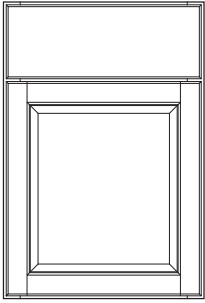

Door 21  
(page 12)

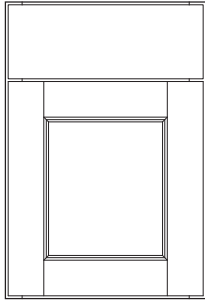

Door 22  
(page 13)

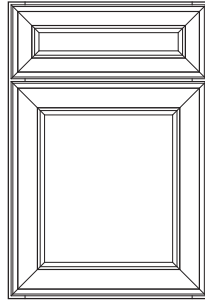

Door 23 **NEW**  
(page 13)

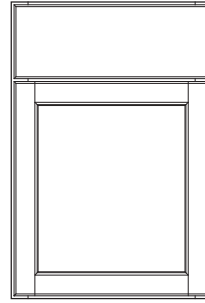

Door 24 **NEW**  
(page 14)

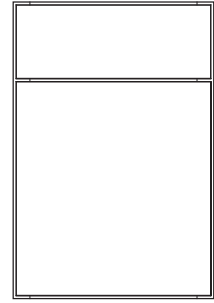

Door 25  
(page 14)

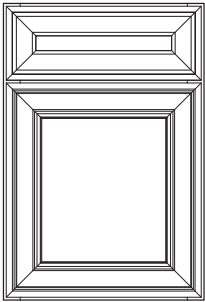

Door 26  
(page 15)

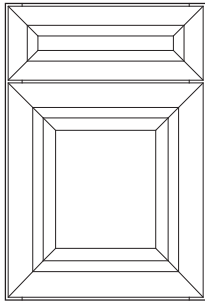

Door 28  
(page 15)

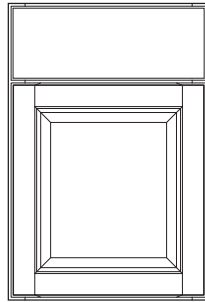

Door 29  
(page 16)

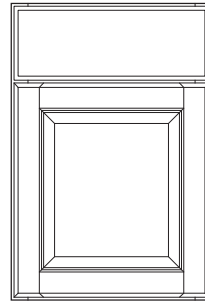

Door 31  
(page 16)

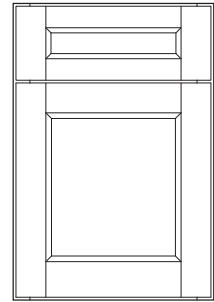

Door 32  
(page 17)

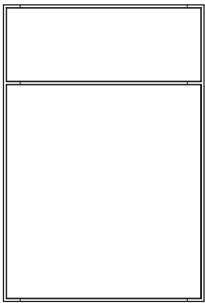

Door 33  
(page 17)

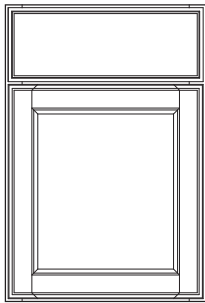

Door 34  
(page 18)

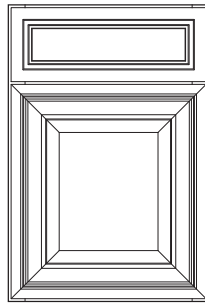

Door 35  
(page 18)

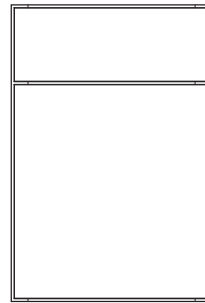

Door 36  
(page 19)

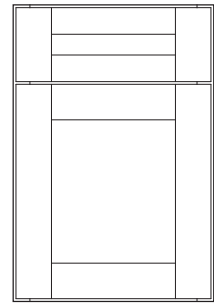

Door 37  
(page 19)

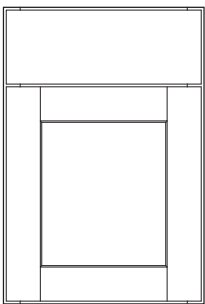

Door 38  
(page 20)

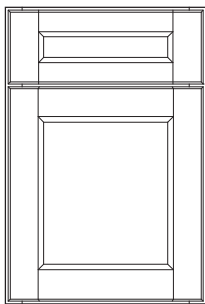

Door 39  
(page 20)

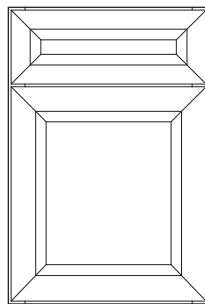

Door 41  
(page 21)

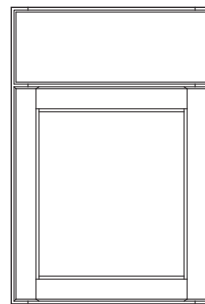

Door 42  
(page 21)

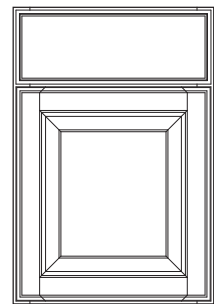

Door 43  
(page 22)

**FULL OVERLAY DOOR STYLES (cont'd)**

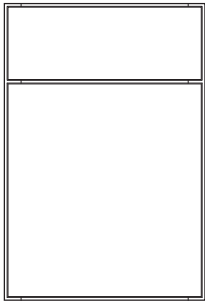

Door 44  
(page 22)

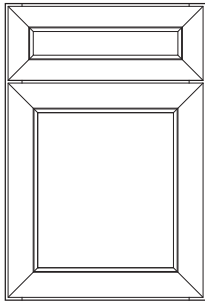

Door 45  
(page 23)

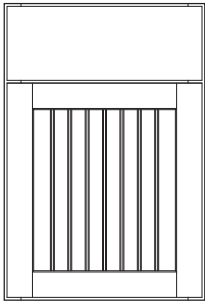

Door 46  
(page 23)

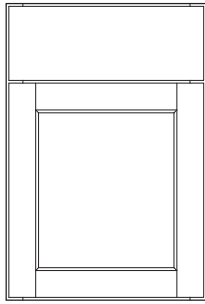

Door 47 **NEW**  
(page 24)

# FULL OVERLAY SPECIFICATIONS

## Full Overlay

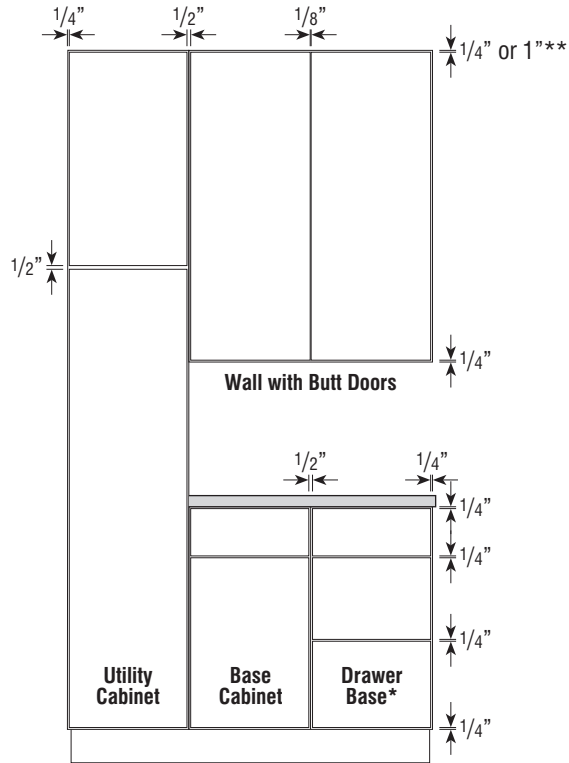

\*34 1/2" high application shown. On 32" high Full Overlay three drawer applications (drawer bases and sink bases with drawers), the reveal above the bottom drawer front is 1/2".

\*\*\*1" reveal when MFO is chosen

One double door center stile cabinet has the same reveal as two single door cabinets.

# DOOR STYLE SPECIFICATIONS

## Cherry

- When Cherry door styles are ordered, it is recommended to apply a finished end option or a veneer end panel for exposed ends due to the natural aging of Cherry.

## Maple

- When a Paint or Paint with Glaze finish is specified, the door and/or drawer front center panel may be constructed of Medium Density Fiberboard (MDF), except when Door 46 door style or when Distressing or Heirlooming are specified. MDF provides a smoother finish when painted, and is more resistant to warping, expansion, and contraction. Doors, drawer fronts, and additional facings may consist of other hardwood components.

## MDF

- MDF door styles will use Maple for trim and panels, refer to Maple in the Species Availability charts.

## All Door Styles

- All doors and drawer fronts are 3/4" thick unless otherwise noted.

## Door and Drawer Front Side Profiles

- Veneer and MDF components are shown with gray shading on side profiles. Solid-wood components do not have shading.
- On MDF door styles, all door and drawer front components will be in MDF.

## Wood Grain

- Door 15 DFF5PCNR and Door 46 have a vertical grain direction on the drawer front center panel.
- See reference images for wood grain direction on all other door styles.

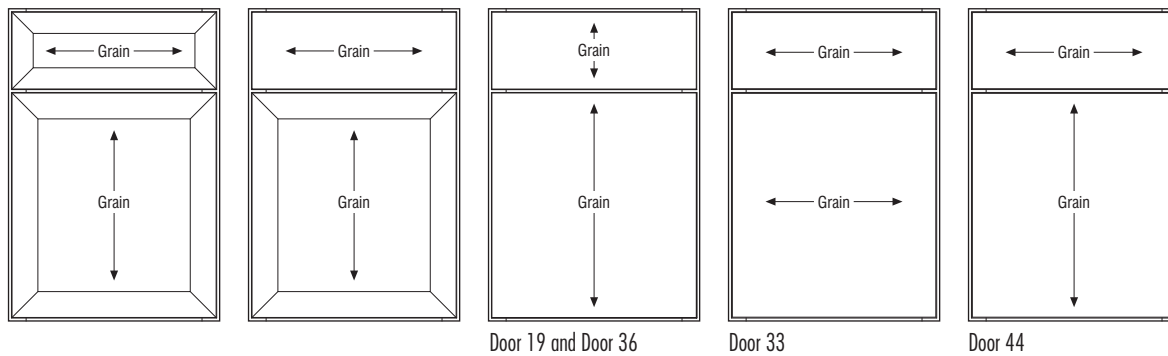

## Wood Grain – Wall Top Hinge (WTH), Wall Vertical-lift (WVL), and Wall Appliance Garage Vertical-lift Door (WAGVLD) Cabinets

- Wall Top Hinge (WTH) Cabinets, 18"-24" Wide
- Wall Appliance Garage Vertical-lift Door (WAGVLD) Cabinets, 15"-24" Wide

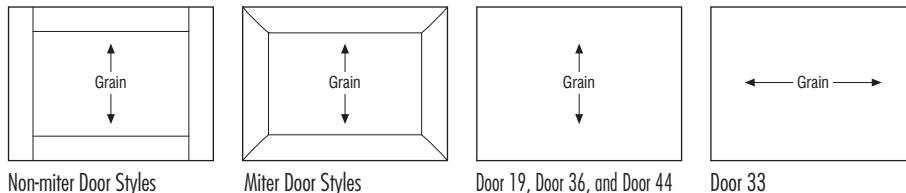

- Wall Top Hinge (WTH) Cabinets, 30"-37" Wide
- Wall Vertical-lift (WVL) Cabinets, 30"-36" Wide

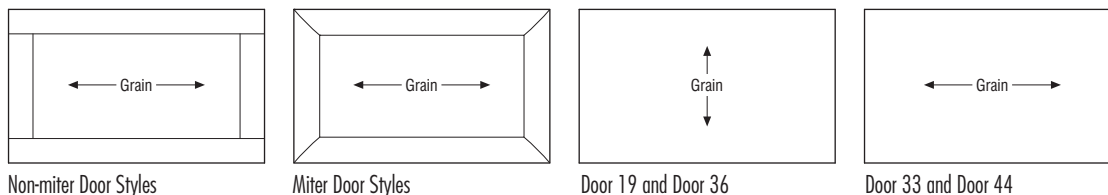

# DOOR STYLES

## Door 15

	Alder	Cherry	Maple*	MDF	Oak	Rustic Alder	Rustic Hickory	Decorative Laminate	Specialty Laminate
Availability	✓	✓	✓	✓	✓	✓	✓	—	—

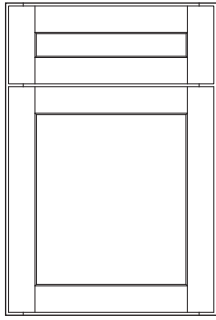

Base

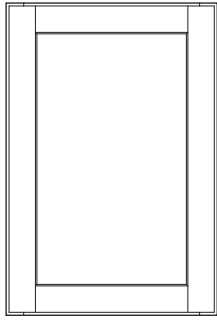

Wall

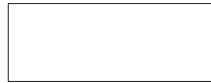

Optional Drawer Front:  
Slab (DFSLB and DFSLBT)

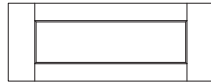

Optional Drawer Front:  
Flat 5-piece Narrow Rails  
(DFF5PCNR and DFF5PCNRST)\*\*\*

**Door Options**

ALF	CG	DPSRR	MD	SHMD	PRMD
•	•	•	•	•	•

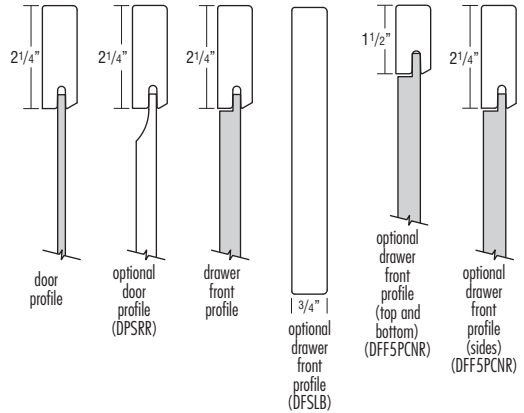
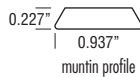

- Veneer\*\* Flat Panel
- Full Overlay
- 5-piece Drawer Front
- Drawer Front Options: DFSLB, DFSLBT, DFF5PCNR, and DFF5PCNRST

- See page 81 for 5-piece drawer front dimensions when specifying decorative hardware.
- \*When a Paint or Paint with Glaze finish is specified, the door and/or drawer front center panel may be constructed of Medium Density Fiberboard (MDF), except when Heirlooming is specified. MDF provides a smoother finish when painted, and is more resistant to warping, expansion, and contraction. Doors, drawer fronts, and additional facings may consist of other hardwood components.
- \*\*When ordered in MDF, all door and drawer front components will be in MDF. DPSRR not available on Door 15 MDF.
- \*\*\*DFF5PCNR not available in Oak. DFF5PCNR drawer front center panel grain direction is vertical.

## Door 16

	Alder	Cherry	Maple*	MDF	Oak	Rustic Alder	Rustic Hickory	Decorative Laminate	Specialty Laminate
Availability	—	✓	✓	—	—	—	—	—	—

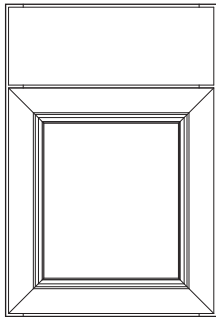

Base

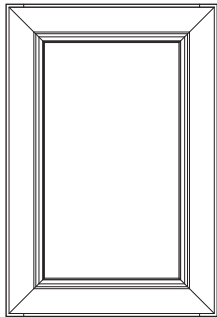

Wall

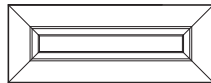

Optional Drawer Front:  
Flat 5-piece (DFF5PC and DFF5PCSLBT)

**Door Options**

ALF	CG	DPSRR	MD	SHMD	PRMD
•	•	•	•	•	•

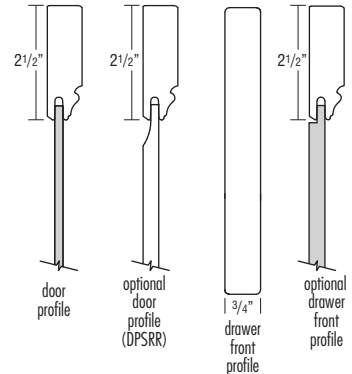
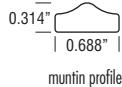

- Veneer Flat Panel Mitered Door
- Full Overlay
- Slab Drawer Front
- Drawer Front Options: DFF5PC and DFF5PCSLBT

- See page 81 for 5-piece drawer front dimensions when specifying decorative hardware.
- \*When a Paint or Paint with Glaze finish is specified, the door center panel may be constructed of Medium Density Fiberboard (MDF), except when Heirlooming is specified. MDF provides a smoother finish when painted, and is more resistant to warping, expansion, and contraction. Doors, drawer fronts, and additional facings may consist of other hardwood components.



# DOOR STYLES

## Door 17

	Alder	Cherry	Maple*	MDF	Oak	Rustic Alder	Rustic Hickory	Decorative Laminate	Specialty Laminate
Availability	—	✓	✓	—	✓	—	✓	—	—

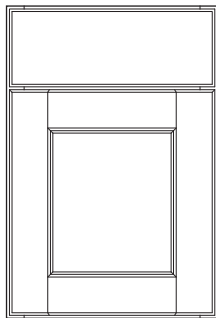

Base

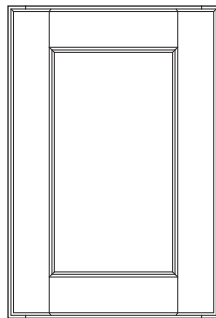

Wall

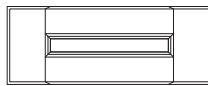

Optional Drawer Front:  
Flat 5-piece (DFF5PC and DFF5PCSLBT)

### Door Options

ALF	CG	DPSRR	MD	SHMD	PRMD
•	•	•	•	•	•

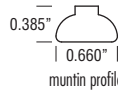

muntin profile

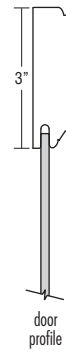

door profile

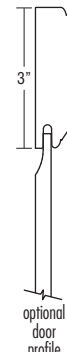

optional door profile (DPSRR)

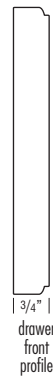

3/4" | drawer front profile

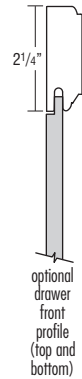

optional drawer front profile (top and bottom)

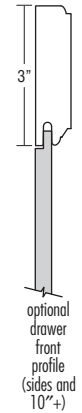

optional drawer front profile (sides and 10"+)

- Veneer Flat Panel
- Full Overlay
- Profiled Slab Drawer Front
- Drawer Front Options: DFF5PC and DFF5PCSLBT

- See page 81 for 5-piece drawer front dimensions when specifying decorative hardware.
- \*When a Paint or Paint with Glaze finish is specified, the door and/or drawer front center panel may be constructed of Medium Density Fiberboard (MDF), except when Heirlooming is specified. MDF provides a smoother finish when painted, and is more resistant to warping, expansion, and contraction. Doors, drawer fronts, and additional facings may consist of other hardwood components.

## Door 18

	Alder	Cherry	Maple*	MDF	Oak	Rustic Alder	Rustic Hickory	Decorative Laminate	Specialty Laminate
Availability	✓	✓	✓	✓	✓	✓	✓	—	—

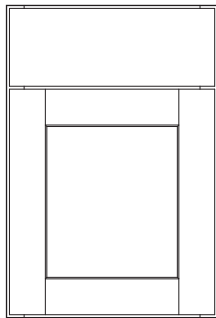

Base

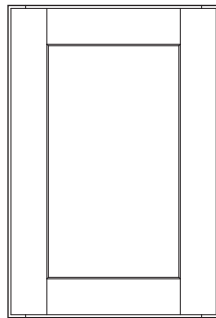

Wall

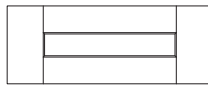

Optional Drawer Front:  
Flat 5-piece (DFF5PC and DFF5PCSLBT)

### Door Options

ALF	CG	DPSRR	MD	SHMD	PRMD
•	•	•	•	•	•

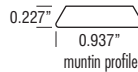

muntin profile

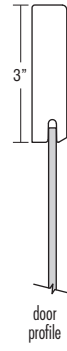

door profile



3/4" | drawer front profile

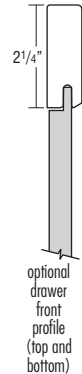

optional drawer front profile (top and bottom)

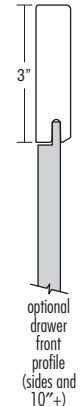

optional drawer front profile (sides and 10"+)

- Veneer\*\* Flat Panel
- Full Overlay
- Slab Drawer Front
- Drawer Front Options: DFF5PC and DFF5PCSLBT

- See page 81 for 5-piece drawer front dimensions when specifying decorative hardware.
- \*When a Paint or Paint with Glaze finish is specified, the door and/or drawer front center panel may be constructed of Medium Density Fiberboard (MDF), except when Heirlooming is specified. MDF provides a smoother finish when painted, and is more resistant to warping, expansion, and contraction. Doors, drawer fronts, and additional facings may consist of other hardwood components.
- \*\*When ordered in MDF, all door and drawer front components will be in MDF.

# DOOR STYLES

## Door 19

	Alder	Cherry	Maple	MDF	Oak	Rustic Alder	Rustic Hickory	Decorative Laminate	Specialty Laminate
Availability	—	✓	✓	✓	—	—	—	—	—

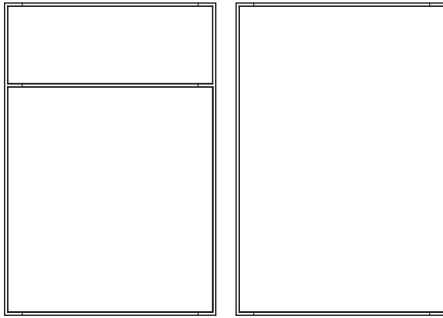

Base Wall

### Door Options

ALF	CG	DPSRR	MD	SHMD	PRMD
•					

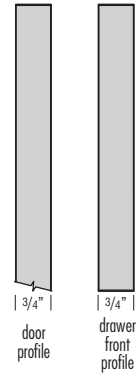

- Slab Doors and Drawer Fronts
- Veneer Face and Back
- Veneer Edging on all Edges
- Furniture Board Core

- Vertical Grain Pattern
- Full Overlay
- When ordered in MDF, all door and drawer front components will be in MDF.

## Door 21

	Alder	Cherry	Maple*	MDF	Oak	Rustic Alder	Rustic Hickory	Decorative Laminate	Specialty Laminate
Availability	—	✓	✓	—	✓	—	—	—	—

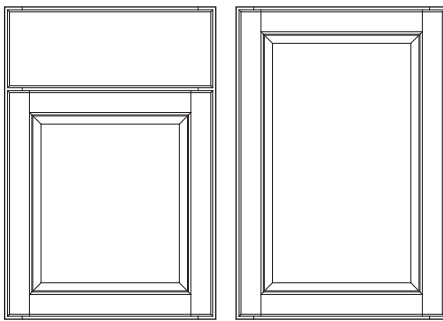

Base Wall

Optional Drawer Front:  
Flat 5-piece (DFF5PC and DFF5PCSLBT)

### Door Options

ALF	CG	DPSRR	MD	SHMD	PRMD
•					

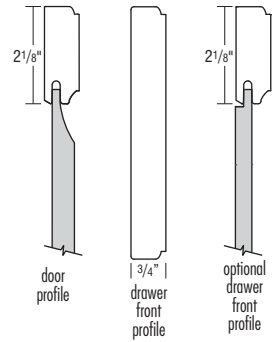
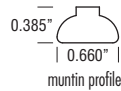

- Veneer Raised Panel
- Full Overlay
- Profiled Slab Drawer Front
- Drawer Front Options: DFF5PC and DFF5PCSLBT

- See page 81 for 5-piece drawer front dimensions when specifying decorative hardware.
- \*When a Paint or Paint with Glaze finish is specified, the door and/or drawer front center panel may be constructed of Medium Density Fiberboard (MDF). MDF provides a smoother finish when painted, and is more resistant to warping, expansion, and contraction. Doors, drawer fronts, and additional facings may consist of other hardwood components.

# DOOR STYLES

## Door 22

	Alder	Cherry	Maple*	MDF	Oak	Rustic Alder	Rustic Hickory	Decorative Laminate	Specialty Laminate
Availability	—	✓	✓	—	—	—	—	—	—

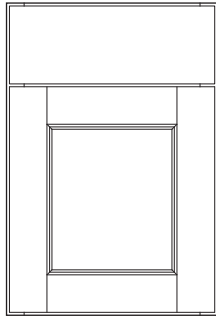

Base

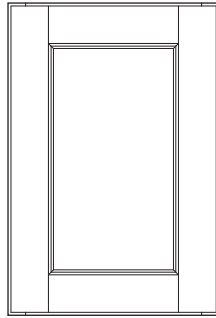

Wall

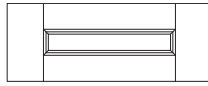

Optional Drawer Front:  
Flat 5-piece (DFF5PC and DFF5PCSLBT)

**Door Options**

ALF	CG	DPSRR	MD	SHMD	PRMD
•	•	•	•	•	•

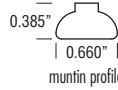

muntin profile

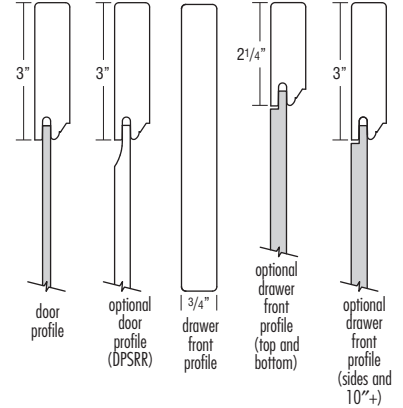

- Veneer Flat Panel
- Full Overlay
- Slab Drawer Front
- Drawer Front Options: DFF5PC and DFF5PCSLBT

- See page 81 for 5-piece drawer front dimensions when specifying decorative hardware.
- \*When a Paint or Paint with Glaze finish is specified, the door and/or drawer front center panel may be constructed of Medium Density Fiberboard (MDF), except when Heirlooming is specified. MDF provides a smoother finish when painted, and is more resistant to warping, expansion, and contraction. Doors, drawer fronts, and additional facings may consist of other hardwood components.

## Door 23

	Alder	Cherry	Maple*	MDF	Oak	Rustic Alder	Rustic Hickory	Decorative Laminate	Specialty Laminate
Availability	—	✓	✓	—	—	—	—	—	—

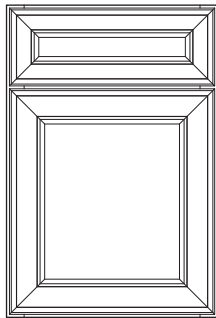

Base

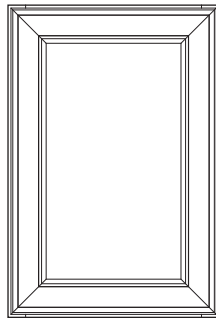

Wall

**Door Options**

ALF	CG	DPSRR	MD	SHMD	PRMD
•	•	•	•	•	•

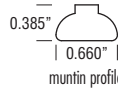

muntin profile

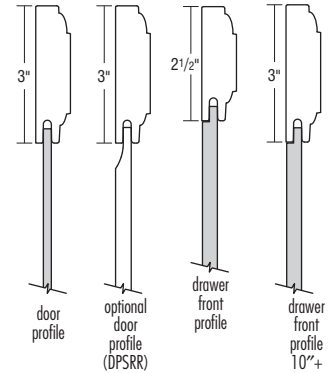

- Veneer Flat Panel Mitered Door
- Full Overlay
- 5-piece Drawer Front Mitered to Match Door

- See page 81 for 5-piece drawer front dimensions when specifying decorative hardware.
- \*When a Paint or Paint with Glaze finish is specified, the door and/or drawer front center panel may be constructed of Medium Density Fiberboard (MDF), except when Heirlooming is specified. MDF provides a smoother finish when painted, and is more resistant to warping, expansion, and contraction. Doors, drawer fronts, and additional facings may consist of other hardwood components.

# DOOR STYLES

## Door 24

Availability	Alder	Cherry	Maple*	MDF	Oak	Rustic Alder	Rustic Hickory	Decorative Laminate	Specialty Laminate
	—	✓	✓	—	✓	—	—	—	—

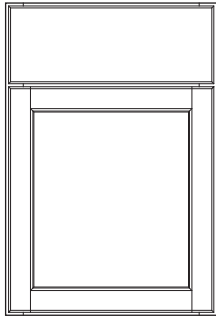

Base

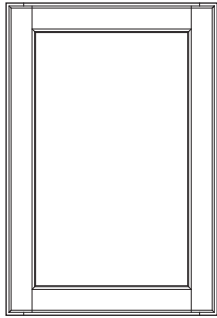

Wall

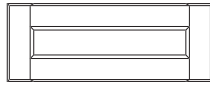

Optional Drawer Front:  
Flat 5-piece (DFF5PC and DFF5PCSLBT)

### Door Options

ALF	CG	DPSRR	MD	SHMD	PRMD
•	•	•	•	•	•

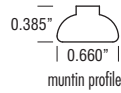

muntin profile

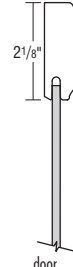

door profile



3/4" | drawer front profile

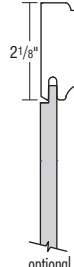

optional drawer front profile

- Veneer Flat Panel
- Full Overlay
- Profiled Slab Drawer Front
- Drawer Front Options: DFF5PC and DFF5PCSLBT

- See page 81 for 5-piece drawer front dimensions when specifying decorative hardware.
- \*When a Paint or Paint with Glaze finish is specified, the door and/or drawer front center panel may be constructed of Medium Density Fiberboard (MDF), except when Heirlooming is specified. MDF provides a smoother finish when painted, and is more resistant to warping, expansion, and contraction. Doors, drawer fronts, and additional facings may consist of other hardwood components.

## Door 25

Availability	Alder	Cherry	Maple	MDF	Oak	Rustic Alder	Rustic Hickory	Decorative Laminate	Specialty Laminate
	—	—	—	—	—	—	—	—	✓

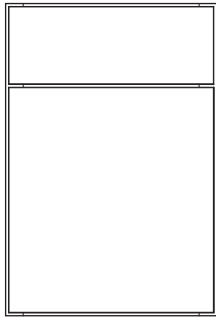

Base

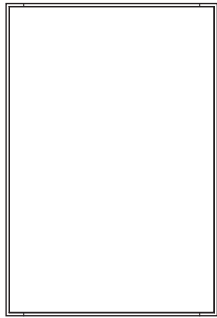

Wall

### Door Options

ALF	CG	DPSRR	MD	SHMD	PRMD
•	•	•	•	•	•



3/4" | door profile



3/4" | drawer front profile



White High Gloss  
Front of Door



White High Gloss  
Metallic High Gloss  
Front of Door

- Slab Doors and Drawer Fronts
- Full Overlay
- Two Edgebanding Options

- Doors, drawer fronts, overlay fillers, and selected premium trim items will be in White High Gloss (see Trim section for availability of premium trim items). Backs of doors, drawer fronts, and Premium panels will be white laminate. All other cabinet components and embellishments will be Painted White.
- A heat shield is required to separate Door 25 doors, drawer fronts, overlay fillers, and all laminate products from heat producing units to be in compliance with cabinet warranty.
- For complementing Contemporary Embellishments, see page 359.

# DOOR STYLES

## Door 26

	Alder	Cherry	Maple*	MDF	Oak	Rustic Alder	Rustic Hickory	Decorative Laminate	Specialty Laminate
Availability	—	✓	✓	—	—	—	—	—	—

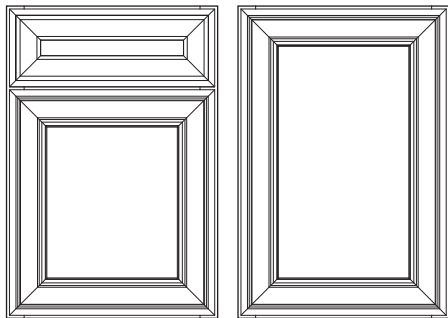

Base

Wall

### Door Options

ALF	CG	DPSRR	MD	SHMD	PRMD
•	•		•		

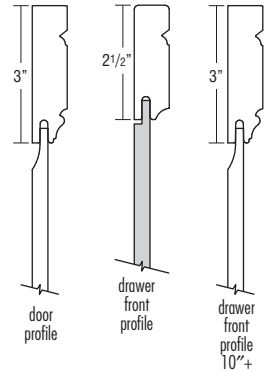
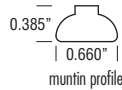

- Miter Doors
- Solid Reverse Raised Panel Door
- Full Overlay
- 5-piece Drawer Front Mitered to Match Door
- Faux Inset Design. Recommended for use with Faux Hinges (see page 370).

- 1/4" space filler or extended stile modification is necessary when applying faux hinge (strap or barrel) on varying depth cabinet or next to an appliance to allow for full door swing clearance.

- See page 81 for 5-piece drawer front dimensions when specifying decorative hardware.

\*When a Paint or Paint with Glaze finish is specified, the door and/or drawer front center panel may be constructed of Medium Density Fiberboard (MDF), except when Heirlooming is specified. MDF provides a smoother finish when painted, and is more resistant to warping, expansion, and contraction. Doors, drawer fronts, and additional facings may consist of other hardwood components.

## Door 28

	Alder	Cherry	Maple*	MDF	Oak	Rustic Alder	Rustic Hickory	Decorative Laminate	Specialty Laminate
Availability	—	✓	✓	—	—	—	✓	—	—

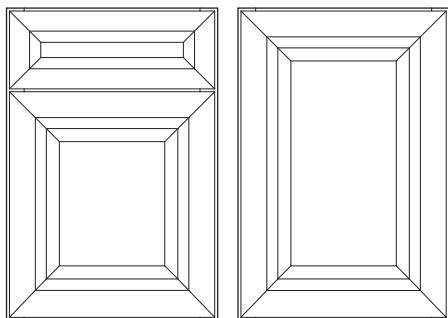

Base

Wall

Optional Drawer Front:  
Slab (DFSLB and DFSLBT)

### Door Options

ALF	CG	DPSRR	MD	SHMD	PRMD
•	•				

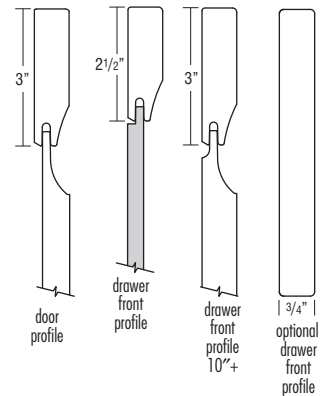

- Solid Raised Panel Mitered Door
- Full Overlay
- 5-piece Drawer Front Mitered to Match Door
- Drawer Front Options: DFSLB and DFSLBT
- Distressing Available

- See page 81 for 5-piece drawer front dimensions when specifying decorative hardware.

\*When a Paint or Paint with Glaze finish is specified, the door and/or drawer front center panel may be constructed of Medium Density Fiberboard (MDF), except when Distressing or Heirlooming are specified. MDF provides a smoother finish when painted, and is more resistant to warping, expansion, and contraction. Doors, drawer fronts, and additional facings may consist of other hardwood components.

# DOOR STYLES

## Door 29

	Alder	Cherry	Maple*	MDF	Oak	Rustic Alder	Rustic Hickory	Decorative Laminate	Specialty Laminate
Availability	—	✓	✓	—	—	—	—	—	—

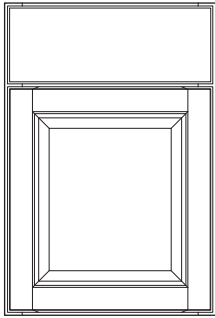

Base

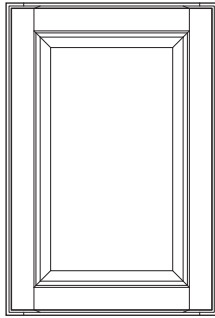

Wall

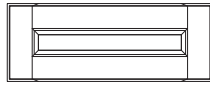

Optional Drawer Front:  
Flat 5-piece (DFF5PC and DFF5PCSLBT)

**Door Options**

ALF	CG	DPSRR	MD	SHMD	PRMD
•	•	•	•	•	•

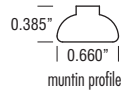

muntin profile

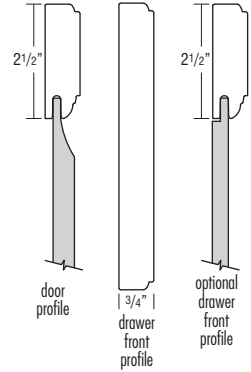

- Veneer Raised Panel
- Full Overlay
- Profiled Slab Drawer Front
- Drawer Front Options: DFF5PC and DFF5PCSLBT

- See page 81 for 5-piece drawer front dimensions when specifying decorative hardware.
- \*When a Paint or Paint with Glaze finish is specified, the door and/or drawer front center panel may be constructed of Medium Density Fiberboard (MDF). MDF provides a smoother finish when painted, and is more resistant to warping, expansion, and contraction. Doors, drawer fronts, and additional facings may consist of other hardwood components.

## Door 31

	Alder	Cherry	Maple	MDF	Oak	Rustic Alder	Rustic Hickory	Decorative Laminate	Specialty Laminate
Availability	✓	—	—	—	—	✓	✓	—	—

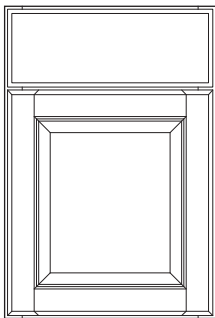

Base

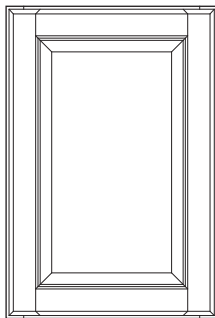

Wall

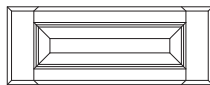

Optional Drawer Front:  
Raised 5-piece (DFR5PC and DFR5PCSLBT)

**Door Options**

ALF	CG	DPSRR	MD	SHMD	PRMD
•	•	•	•	•	•



muntin profile

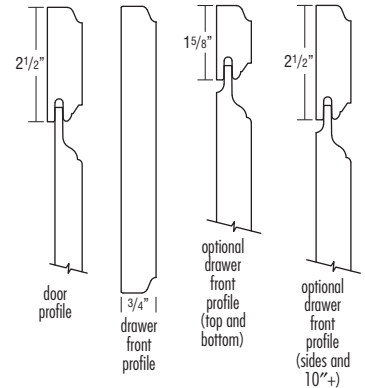

- Solid Raised Panel
- Full Overlay
- Profiled Slab Drawer Front

- Drawer Front Options: DFR5PC and DFR5PCSLBT
- Distressing Available
- See page 81 for 5-piece drawer front dimensions when specifying decorative hardware.

# DOOR STYLES

## Door 32

	Alder	Cherry	Maple*	MDF	Oak	Rustic Alder	Rustic Hickory	Decorative Laminate	Specialty Laminate
Availability	—	✓	✓	✓	—	—	—	—	—

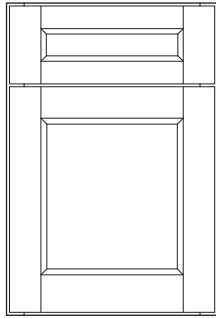

Base

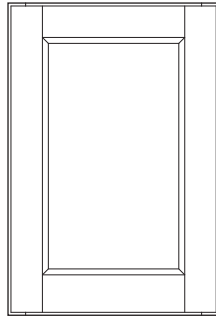

Wall



Optional Drawer Front:  
Slab (DFSLB and DFSLBT)

**Door Options**

ALF	CG	DPSRR	MD	SHMD	PRMD
•	•	•	•	•	•

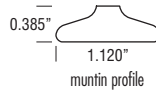

muntin profile

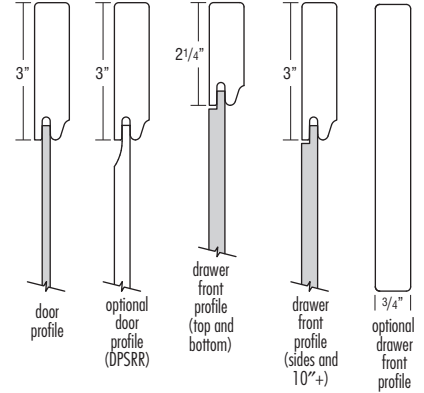

- Veneer\*\* Flat Panel
- Full Overlay
- 5-piece Drawer Front
- Drawer Front Options: DFSLB and DFSLBT

- See page 81 for 5-piece drawer front dimensions when specifying decorative hardware.

\*When a Paint or Paint with Glaze finish is specified, the door and/or drawer front center panel may be constructed of Medium Density Fiberboard (MDF), except when Heirlooming is specified. MDF provides a smoother finish when painted, and is more resistant to warping, expansion, and contraction. Doors, drawer fronts, and additional facings may consist of other hardwood components.

\*\*When ordered in MDF, all door and drawer front components will be in MDF. DPSRR not available on Door 32 MDF.

## Door 33

	Alder	Cherry	Maple	MDF	Oak	Rustic Alder	Rustic Hickory	Decorative Laminate	Specialty Laminate
Availability	—	—	—	—	—	—	—	—	✓

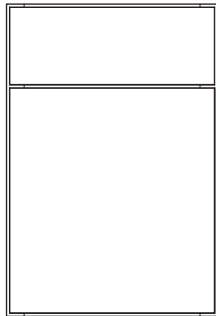

Base

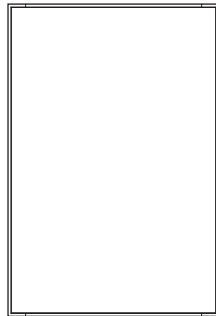

Wall

**Door Options**

ALF	CG	DPSRR	MD	SHMD	PRMD
•					

**Finishes Cabinet Box Color Options**

	Paint A	Paint C	Paint F	Paint Q†	Paint AD	Stain Z
Laminate AH	•	•	•	•	•	•
Laminate AL				•		•

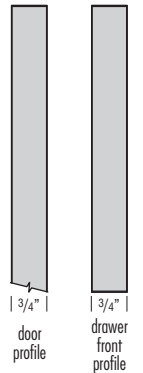

- Laminate Slab Door and Drawer Front with Matching Edgebanding
- Laminate AH and Laminate AL feature a textured surface.
- Horizontal Grain Pattern for Contemporary Styling
- Full Overlay
- Doors, drawer fronts, overlay fillers, and selected premium trim items will be in the selected laminate. All other cabinet components and trim items will be in the selected cabinet box color.

- Doors and overlay fillers greater than 48" high will be two pieces. Doors will be doweled together with zinc connector pins and black plastic spacers. Replacement doors will be drilled and doweled but require field assembly.
- A heat shield is required to separate Door 33 doors, drawer fronts, overlay fillers, and all textured laminate products from heat producing units to be in compliance with cabinet warranty.
- For complementing Contemporary Embellishments, see page 359.
- Stain Z box color will have visible vertical grain matching end panels.

†Standard construction features non-matching laminate ends. Requires a veneer end upgrade (PE or APC) with FB, FPB, Authentic End upgrade, or a field applied skin or door kit to achieve a matching cabinet end panel.

# DOOR STYLES

## Door 34

	Alder	Cherry	Maple*	MDF	Oak	Rustic Alder	Rustic Hickory	Decorative Laminate	Specialty Laminate
Availability	—	✓	✓	—	—	—	—	—	—

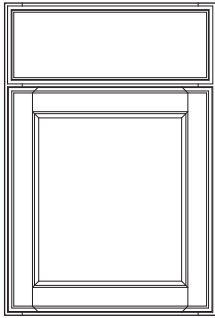

Base

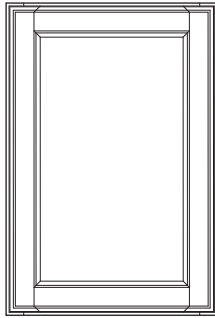

Wall

### Door Options

ALF	CG	DPSRR	MD	SHMD	PRMD
•	•	•			

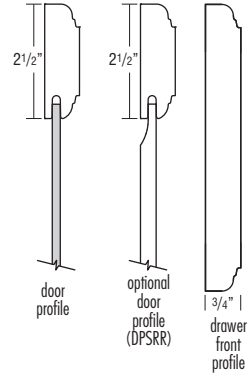
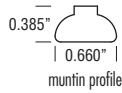

- Veneer Flat Panel
- Full Overlay
- Profiled Slab Drawer Front

\*When a Paint or Paint with Glaze finish is specified, the door center panel may be constructed of Medium Density Fiberboard (MDF), except when Heirlooming is specified. MDF provides a smoother finish when painted, and is more resistant to warping, expansion, and contraction. Doors, drawer fronts, and additional facings may consist of other hardwood components.

## Door 35

	Alder	Cherry	Maple*	MDF	Oak	Rustic Alder	Rustic Hickory	Decorative Laminate	Specialty Laminate
Availability	✓	✓	✓	—	—	—	—	—	—

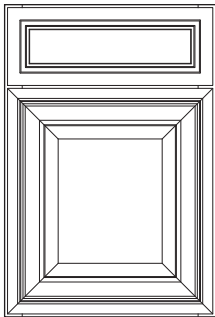

Base

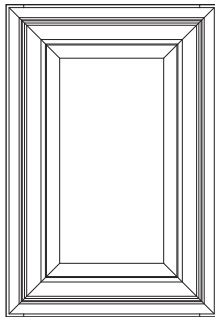

Wall

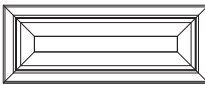

Optional Drawer Front:  
Flat 5-piece (DFF5PC and DFF5PCSLBT)

### Door Options

ALF	CG	DPSRR	MD	SHMD	PRMD
•	•				

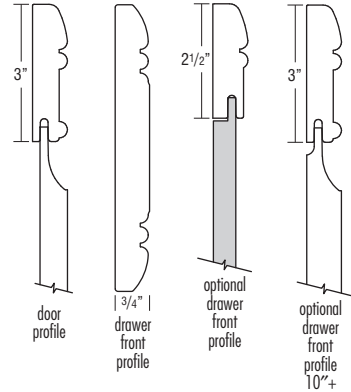

- Miter Doors
- Solid Raised Panel on Door and Large 5-piece Drawer Fronts
- Full Overlay
- Solid Routed Drawer Front
- Drawer Front Options: DFF5PC and DFF5PCSLBT
- 5-piece 6 1/4" and 6 3/4" high drawer fronts have a flat center panel, 10" and taller drawer fronts have a raised center panel.

- Distressing Available

• See page 81 for 5-piece drawer front dimensions when specifying decorative hardware.

\*When a Paint or Paint with Glaze finish is specified, the door and/or drawer front center panel may be constructed of Medium Density Fiberboard (MDF), except when Distressing or Heirlooming are specified. MDF provides a smoother finish when painted, and is more resistant to warping, expansion, and contraction. Doors, drawer fronts, and additional facings may consist of other hardwood components.



# DOOR STYLES

## Door 36

	Alder	Cherry	Maple	MDF	Oak	Rustic Alder	Rustic Hickory	Decorative Laminate	Specialty Laminate
Availability	—	—	—	—	—	—	—	—	✓

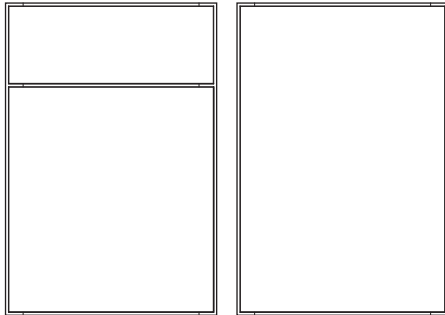

Base

Wall

### Door Options

ALF	CG	DPSRR	MD	SHMD	PRMD
•					

### Finishes Cabinet Box Color Options

	Paint A	Paint C	Paint F	Paint AD	Stain K	Stain M	Stain P	Stain T	Stain Y
Laminate AI					•			•	•
Laminate AJ					•	•			
Laminate AK		•							
Laminate AM	•			•					
Laminate AN	•		•	•			•	•	

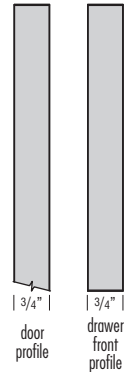

- Slab Door and Drawer Front with Matching Edgebanding
- Laminate AI, Laminate AJ, and Laminate AM feature a textured surface. Laminate AK and Laminate AN are non-textured.
- Vertical Grain Pattern
- Full Overlay

- Doors, drawer fronts, overlay fillers, and selected premium trim items will be in the selected laminate. All other cabinet components and trim items will be in the selected cabinet box color.
- A heat shield is required to separate Door 36 doors, drawer fronts, overlay fillers, and all laminate products from heat producing units to be in compliance with cabinet warranty.
- For complementing Contemporary Embellishments, see page 359.
- Wood Tone Stain box colors will have visible vertical grain matching end panels.

## Door 37

	Alder	Cherry	Maple	MDF	Oak	Rustic Alder	Rustic Hickory	Decorative Laminate	Specialty Laminate
Availability	—	—	—	—	—	—	—	✓	—

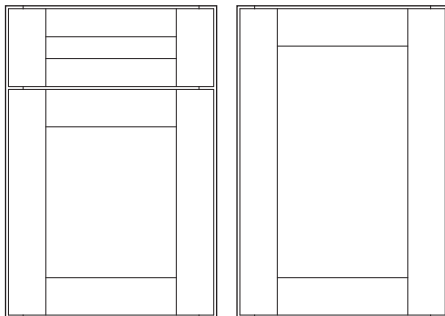

Base

Wall

### Door Options

ALF	CG	DPSRR	MD	SHMD	PRMD
•					

### Finishes Cabinet Box Color Options

	Paint C	Stain K	Stain M	Stain T	Stain Y
Laminate AI		•		•	•
Laminate AJ		•	•		
Laminate AK	•				

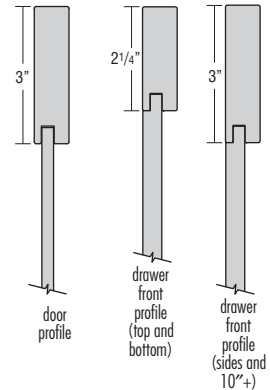

- Laminate Wrapped MDF Door and Drawer Rails
- Full Overlay
- 5-piece Drawer Front

- Doors, drawer fronts, overlay fillers, and selected premium trim items will be in the selected laminate. All other cabinet components and embellishments will be in selected cabinet box color and species.
- A heat shield is required to separate Door 37 doors, drawer fronts, overlay fillers, and all laminate products from heat producing units to be in compliance with cabinet warranty.
- See page 81 for 5-piece drawer front dimensions when specifying decorative hardware.
- Wood Tone Stain box colors will have visible vertical grain matching end panels.

# DOOR STYLES

## Door 38

	Alder	Cherry	Maple*	MDF	Oak	Rustic Alder	Rustic Hickory	Decorative Laminate	Specialty Laminate
Availability	✓	✓	✓	—	✓	✓	✓	—	—

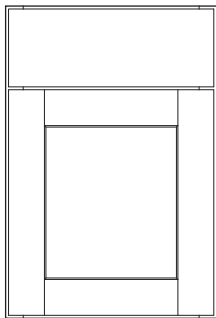

Base

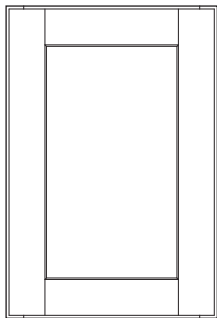

Wall

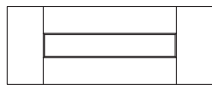

Optional Drawer Front:  
Flat 5-piece (DFF5PC and DFF5PCSLBT)

**Door Options**

ALF	CG	DPSRR	MD	SHMD	PRMD
•	•	•	•	•	•

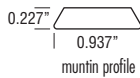

muntin profile



door profile



drawer front profile

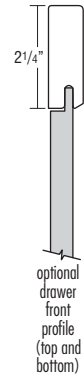

optional drawer front profile (top and bottom)

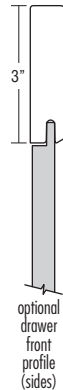

optional drawer front profile (sides)

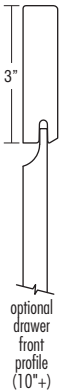

optional drawer front profile (10"+)

- Solid Reverse Raised Panel Door
- Full Overlay
- Slab Drawer Front
- Drawer Front Options: DFF5PC and DFF5PCSLBT

- See page 81 for 5-piece drawer front dimensions when specifying decorative hardware.

\*When a Paint or Paint with Glaze finish is specified, the door and/or drawer front center panel may be constructed of Medium Density Fiberboard (MDF), except when Heirlooming is specified. MDF provides a smoother finish when painted, and is more resistant to warping, expansion, and contraction. Doors, drawer fronts, and additional facings may consist of other hardwood components.

## Door 39

	Alder	Cherry	Maple*	MDF	Oak	Rustic Alder	Rustic Hickory	Decorative Laminate	Specialty Laminate
Availability	—	✓	✓	—	—	—	—	—	—

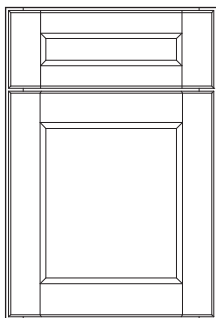

Base

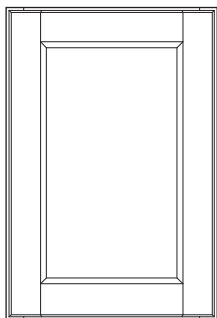

Wall



Optional Drawer Front:  
Slab (DFSLLB and DFSLBT)

**Door Options**

ALF	CG	DPSRR	MD	SHMD	PRMD
•	•	•	•	•	•

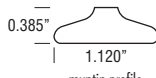

muntin profile

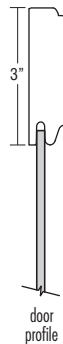

door profile

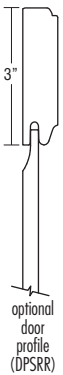

optional door profile (DPSRR)

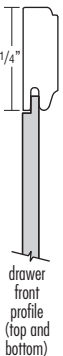

drawer front profile (top and bottom)

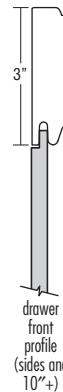

drawer front profile (sides and 10"+)



optional drawer front profile

- Veneer Flat Panel
- Full Overlay
- 5-piece Drawer Front
- Drawer Front Options: DFSLLB and DFSLBT

- See page 81 for 5-piece drawer front dimensions when specifying decorative hardware.

\*When a Paint or Paint with Glaze finish is specified, the door and/or drawer front center panel may be constructed of Medium Density Fiberboard (MDF), except when Heirlooming is specified. MDF provides a smoother finish when painted, and is more resistant to warping, expansion, and contraction. Doors, drawer fronts, and additional facings may consist of other hardwood components.

# DOOR STYLES

## Door 41

	Alder	Cherry	Maple*	MDF	Oak	Rustic Alder	Rustic Hickory	Decorative Laminate	Specialty Laminate
Availability	—	✓	✓	—	—	—	—	—	—

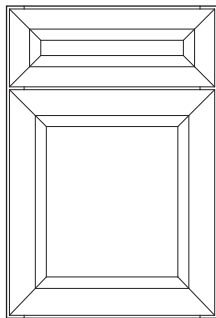

Base

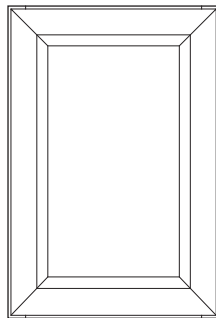

Wall

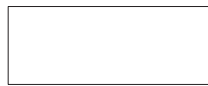

Optional Drawer Front: Slab (DFSLB and DFSLBT)

### Door Options

ALF	CG	DPSRR	MD	SHMD	PRMD
•	•	•	•	•	•

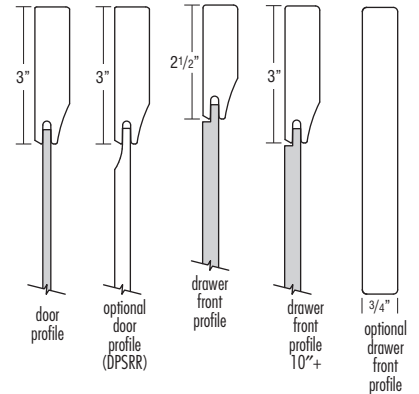

- Veneer Flat Panel Mitered Door
- Full Overlay
- 5-piece Drawer Front Mitered to Match Door
- Drawer Front Options: DFSLB and DFSLBT

- See page 81 for 5-piece drawer front dimensions when specifying decorative hardware.

\*When a Paint or Paint with Glaze finish is specified, the door and/or drawer front center panel may be constructed of Medium Density Fiberboard (MDF), except when Heirlooming is specified. MDF provides a smoother finish when painted, and is more resistant to warping, expansion, and contraction. Doors, drawer fronts, and additional facings may consist of other hardwood components.

## Door 42

	Alder	Cherry	Maple*	MDF	Oak	Rustic Alder	Rustic Hickory	Decorative Laminate	Specialty Laminate
Availability	✓	✓	✓	—	—	✓	✓	—	—

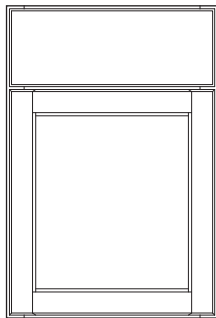

Base

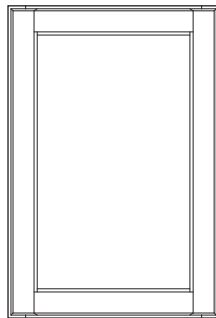

Wall

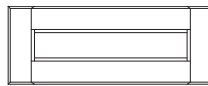

Optional Drawer Front: Flat 5-piece (DFF5PC and DFF5PCSLBT)

### Door Options

ALF	CG	DPSRR	MD	SHMD	PRMD
•	•	•	•	•	•

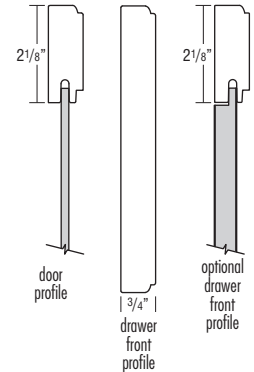
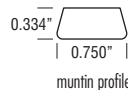

- Veneer Flat Panel
- Full Overlay
- Profiled Slab Drawer Front
- Drawer Front Options: DFF5PC and DFF5PCSLBT

- See page 81 for 5-piece drawer front dimensions when specifying decorative hardware.

\*When a Paint or Paint with Glaze finish is specified, the door and/or drawer front center panel may be constructed of Medium Density Fiberboard (MDF), except when Heirlooming is specified. MDF provides a smoother finish when painted, and is more resistant to warping, expansion, and contraction. Doors, drawer fronts, and additional facings may consist of other hardwood components.

# DOOR STYLES

## Door 43

	Alder	Cherry	Maple*	MDF	Oak	Rustic Alder	Rustic Hickory	Decorative Laminate	Specialty Laminate
Availability	—	✓	✓	—	—	—	—	—	—

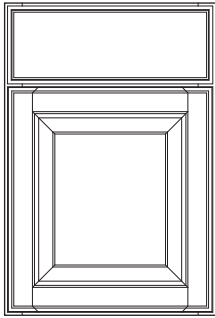

Base

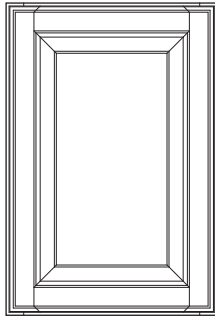

Wall



Optional Drawer Front:  
Raised 5-piece (DFR5PC and DFR5PCSLBT)

**Door Options**

ALF	CG	DPSRR	MD	SHMD	PRMD
•			•		

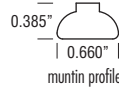

muntin profile



door profile



1 3/4" | drawer front profile



optional drawer front profile (top and bottom)



optional drawer front profile (sides and 10"+)

- Solid Raised Panel
- Full Overlay
- Slab Drawer Front
- Drawer Front Options: DFR5PC and DFR5PCSLBT
- Distressing Available

- See page 81 for 5-piece drawer front dimensions when specifying decorative hardware.

\*When a Paint or Paint with Glaze finish is specified, the door and/or drawer front center panel may be constructed of Medium Density Fiberboard (MDF), except when Distressing or Heirlooming are specified. MDF provides a smoother finish when painted, and is more resistant to warping, expansion, and contraction. Doors, drawer fronts, and additional facings may consist of other hardwood components.

## Door 44

	Alder	Cherry	Maple	MDF	Oak	Rustic Alder	Rustic Hickory	Decorative Laminate	Specialty Laminate
Availability	—	✓	✓	—	—	—	—	—	—

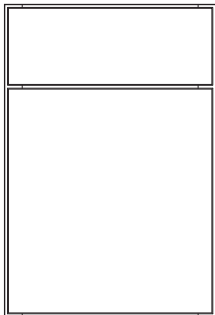

Base

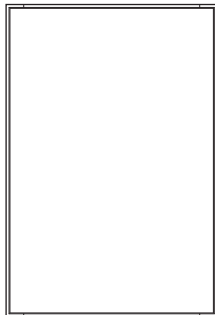

Wall

**Door Options**

ALF	CG	DPSRR	MD	SHMD	PRMD
•					



door profile



1 3/4" | drawer front profile

- Slab Doors and Drawer Fronts
- Veneer Face and Back
- Wood Edging on All Edges

- Furniture Board Core
- Full Overlay
- Grain direction is vertical on doors and horizontal on drawer fronts.

# DOOR STYLES

## Door 45

	Alder	Cherry	Maple*	MDF	Oak	Rustic Alder	Rustic Hickory	Decorative Laminate	Specialty Laminate
Availability	—	✓	✓	—	—	—	—	—	—

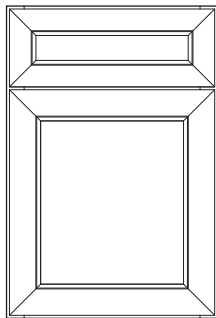

Base

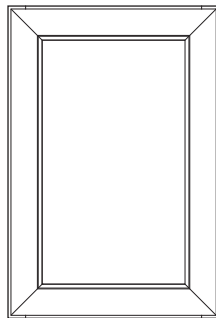

Wall

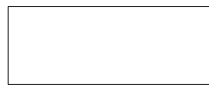

Optional Drawer Front:  
Slab (DFSLB and DFSLBT)

**Door Options**

ALF	CG	DPSRR	MD	SHMD	PRMD
•	•	•	•	•	•

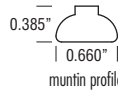

muntin profile

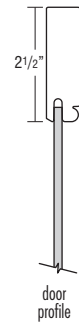

door profile

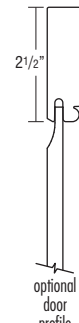

optional door profile (DPSRR)

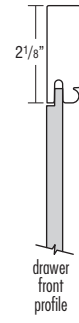

drawer front profile

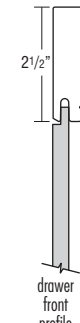

drawer front profile 10"+

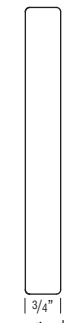

optional drawer front profile

- Miter Doors
- Veneer Flat Panel
- Full Overlay
- 5-piece Drawer Front Mitered to Match Door
- Drawer Front Options: DFSLB and DFSLBT

- See page 81 for 5-piece drawer front dimensions when specifying decorative hardware.

\*When a Paint or Paint with Glaze finish is specified, the door and/or drawer front center panel may be constructed of Medium Density Fiberboard (MDF), except when Heirlooming is specified. MDF provides a smoother finish when painted, and is more resistant to warping, expansion, and contraction. Doors, drawer fronts, and additional facings may consist of other hardwood components.

## Door 46

	Alder	Cherry	Maple	MDF	Oak	Rustic Alder	Rustic Hickory	Decorative Laminate	Specialty Laminate
Availability	—	✓	✓	—	—	—	—	—	—

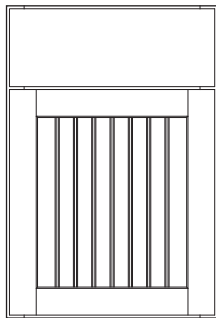

Base

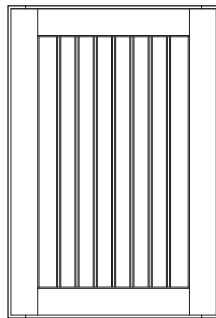

Wall

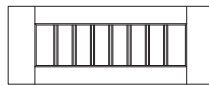

Optional Drawer Front:  
Flat 5-piece (DFF5PC and DFF5PCSLBT)

**Door Options**

ALF	CG	DPSRR	MD	SHMD	PRMD
•	•	•	•	•	•

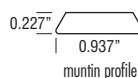

muntin profile

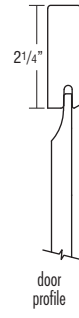

door profile

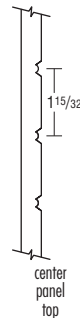

center panel top view



optional drawer front profile (top and bottom)

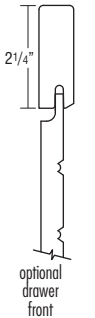

optional drawer front profile (sides)

- Solid Reverse Raised Beaded Panel
- Full Overlay
- Slab Drawer Front
- Drawer Front Options: DFF5PC and DFF5PCSLBT

- When DFF5PC is selected on a 2DB48, drawer front will have a vertical cross rail with two center panels.
- Will not use MDF center panel on Paint or Paint with Glaze finishes. See page 9 for more details.
- Beaded center panel on 5-piece drawer fronts will not align with doors when used on cabinets with double doors and a full width drawer.
- See page 81 for 5-piece drawer front dimensions when specifying decorative hardware.

# DOOR STYLES

Door 47 

	Alder	Cherry	Maple*	MDF	Oak	Rustic Alder	Rustic Hickory	Decorative Laminate	Specialty Laminate
Availability	✓	✓	✓	—	—	✓	—	—	—

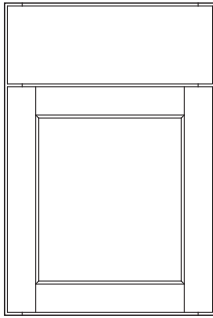

Base

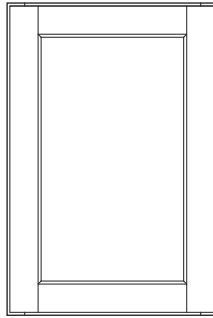

Wall

**Door Options**

ALF	CG	DPSRR	MD	SHMD	PRMD
•	•	•	•	•	•

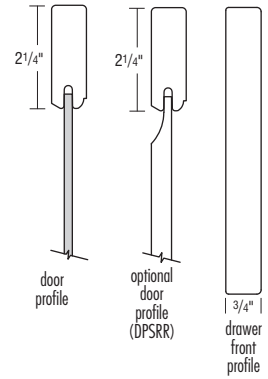
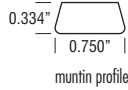

- Veneer Flat Panel
- Full Overlay
- Profiled Slab Drawer Front

\*When a Paint or Paint with Glaze finish is specified, the door and/or drawer front center panel may be constructed of Medium Density Fiberboard (MDF), except when Heirlooming is specified. MDF provides a smoother finish when painted, and is more resistant to warping, expansion, and contraction. Doors, drawer fronts, and additional facings may consist of other hardwood components.

# NOTES

**NOTES**



## PREMIUM COLOR PALETTE

	OPTION NAME	DESCRIPTION/LIMITATIONS	MATCHING LAMINATE ENDS <sup>▲</sup>	DISTRESSING AVAILABILITY	HEIRLOOMING AVAILABILITY	MATTE SHEEN AVAILABILITY
Stains	<b>Stain V</b>	A deep brown finish with gray undertones and beautiful depth.	✓	✓	N/A	✓
	<b>Stain Z</b>	A semi translucent stone gray finish that allows the natural tones and characteristics of the wood to show through.	Maple ✓ Cherry N/A	✓	✓	✓
Stains with Flooded Glazes	<b>Glaze AC</b>	A two tone finish. Dark glaze over a warmer toner that emulates a soft, Old World look and enhances the door profiles.	✓	✓	N/A	✓
	<b>Glaze Combo 124</b>	A two tone finish. A medium toned finish that is highlighted with a dark glaze.	✓	✓	N/A	✓
	<b>Glaze Combo 125</b>	A two tone finish. A light toned finish that is highlighted with a dark espresso glaze. The glaze is meant to be seen primarily in the profiled areas and has minimal affect to the overall color.	✓	✓	N/A	✓
	<b>Glaze Combo 126</b>	A warm finish with a rich dark patina to create a true reproduction of a period style antique.	✓	✓	N/A	✓
Paints*	<b>Paint A</b>	Bright, pure white	✓	N/A	N/A	N/A
	<b>Paint B</b>	Creamy off white	✓	N/A	N/A	N/A
	<b>Paint C</b>	Cool white with gray undertones	✓	N/A	N/A	N/A
	<b>Paint F</b>	Medium gray	✓	✓	N/A	N/A
	<b>Paint J</b>	Cool dark gray	✓	✓	✓	N/A
	<b>Paint L</b>	Dark navy with gray/green undertones	✓	✓	✓	N/A
	<b>Paint O</b> 	Classic navy	✓	✓	✓	N/A
	<b>Paint Q</b>	True black	N/A	✓	✓	N/A
	<b>Paint AD</b>	White with a taupe undertone	✓	N/A	N/A	N/A
	<b>Paint AE</b>	Deep green	N/A	✓	✓	N/A

<sup>▲</sup>In Standard construction, cabinets will have matching laminate ends. Where not available, ends will be Natural Maple laminate and a finished end treatment would be needed for an exposed end.

\*On wood products, normal movement is typical due to change in climatic conditions. This will cause hairline cracks at stile, rail and panel joints. This hairline cracking is a normal characteristic of painted finishes and will not be considered a reason for product replacement. Finish agreement required, see page 394.

UNFINISHED			
OPTION NAME	DESCRIPTION/LIMITATIONS	DISTRESSING AVAILABILITY	HEIRLOOMING AVAILABILITY
Unfinished	Must upgrade to PE or APC. When cabinets are finished by an outside source, finish is not covered under warranty. Interiors of cabinets will be Natural Maple laminate. For finishable interiors, MIP must be specified. Cabinets have a species-matching veneer for finishable plywood ends.	✓	N/A

FINISH TECHNIQUES	
OPTION NAME	DESCRIPTION
<b>Distressing</b>	Provides a rustic look through the carefully crafted application of distressing characteristics such as dents, wormholes, chisel marks, and other signs of wear on solid-wood doors, drawer fronts, face frames, and <b>selected</b> trim items (veneer parts will not be distressed). The distressing technique creates a finish with unique and appealing imperfections, similar to those of time-worn antiques. Distressing characteristics are more visible with glaze finishes (face frames and trim items without detailed profiles will not feature glaze hang-up on distressed areas). When applied to a design in 20/20, all items in the order will receive the distressing upcharge. Not available to order with Paint A, Paint AD, Paint B, and Paint C. Not available on MDF.
<b>Heirlooming</b>	Available on select finishes. The finish will be sanded through the base coat to expose the surface of the wood. This type of sand through on the edges and profiles creates a naturally worn appearance. If a finish is chosen with a glaze, the glaze will be applied after the sanding has been done. This will enhance those areas of exposed wood to take on the darker characteristic of the applied glaze. Not available on Door 19, Door 21, Door 29, and Door 44.  Select trim pieces will feature Heirlooming characteristics. See Trim section for availability.

SHEEN OPTION	
OPTION NAME	DESCRIPTION
<b>Matte Sheen</b>	Available on Stains and Stains with Flooded Glazes.  Replaces standard top coat with a low sheen, non-pigmented top coat on doors, drawer fronts, face frames, trim items, and veneer finished cabinet components in selected finish. Does not affect laminate or clear finished components.

# FINISH AVAILABILITY

		MAPLE																											
		Matching Laminate Ends <sup>▲</sup>	Heirloom <sup>Ⓢ</sup>	Matte Sheen	Door 15	Door 16	Door 17	Door 18	Door 19	Door 21	Door 22	Door 23 <sup>NEW</sup>	Door 24 <sup>NEW</sup>	Door 26	Door 28	Door 29	Door 32	Door 34	Door 35	Door 38	Door 39	Door 41	Door 42	Door 43	Door 44	Door 45	Door 46	Door 47 <sup>NEW</sup>	
Stains	Stain D	✓		✓	✓	✓	✓	✓	✓	✓	✓	✓	✓	✓	✓	✓	✓	✓	✓	✓	✓	✓	✓	✓	✓	✓	✓	✓	
	Stain E	✓		✓	✓	✓	✓	✓	✓	✓	✓	✓	✓	✓	✓	✓	✓	✓	✓	✓	✓	✓	✓	✓	✓	✓	✓	✓	
	Stain G	✓		✓	✓	✓	✓	✓	✓	✓	✓	✓	✓	✓	✓	✓	✓	✓	✓	✓	✓	✓	✓	✓	✓	✓	✓	✓	
	Stain I	✓		✓	✓	✓	✓	✓	✓	✓	✓	✓	✓	✓	✓	✓	✓	✓	✓	✓	✓	✓	✓	✓	✓	✓	✓	✓	
	Stain K	✓		✓	✓	✓	✓	✓	✓	✓	✓	✓	✓	✓	✓	✓	✓	✓	✓	✓	✓	✓	✓	✓	✓	✓	✓	✓	
	Stain M	✓		✓	✓	✓	✓	✓	✓	✓	✓	✓	✓	✓	✓	✓	✓	✓	✓	✓	✓	✓	✓	✓	✓	✓	✓	✓	
	Stain N <sup>NEW</sup>	✓		✓	✓	✓	✓	✓	✓	✓	✓	✓	✓	✓	✓	✓	✓	✓	✓	✓	✓	✓	✓	✓	✓	✓	✓	✓	
	Stain P	✓		✓	✓	✓	✓	✓	✓	✓	✓	✓	✓	✓	✓	✓	✓	✓	✓	✓	✓	✓	✓	✓	✓	✓	✓	✓	✓
	Stain T	✓		✓	✓	✓	✓	✓	✓	✓	✓	✓	✓	✓	✓	✓	✓	✓	✓	✓	✓	✓	✓	✓	✓	✓	✓	✓	✓
	Stain U	✓		✓	✓	✓	✓	✓	✓	✓	✓	✓	✓	✓	✓	✓	✓	✓	✓	✓	✓	✓	✓	✓	✓	✓	✓	✓	✓
	Stain V	✓		✓	✓	✓	✓	✓	✓	✓	✓	✓	✓	✓	✓	✓	✓	✓	✓	✓	✓	✓	✓	✓	✓	✓	✓	✓	✓
	Stain W	✓		✓	✓	✓	✓	✓	✓	✓	✓	✓	✓	✓	✓	✓	✓	✓	✓	✓	✓	✓	✓	✓	✓	✓	✓	✓	✓
	Stain Y	✓		✓	✓	✓	✓	✓	✓	✓	✓	✓	✓	✓	✓	✓	✓	✓	✓	✓	✓	✓	✓	✓	✓	✓	✓	✓	✓
	Stain Z	✓	✓	✓	✓	✓	✓	✓	✓	✓	✓	✓	✓	✓	✓	✓	✓	✓	✓	✓	✓	✓	✓	✓	✓	✓	✓	✓	✓
	Stain AA	✓		✓	✓	✓	✓	✓	✓	✓	✓	✓	✓	✓	✓	✓	✓	✓	✓	✓	✓	✓	✓	✓	✓	✓	✓	✓	✓
Unfinished				✓	✓	✓	✓	✓	✓	✓	✓	✓	✓	✓	✓	✓	✓	✓	✓	✓	✓	✓	✓	✓	✓	✓	✓	✓	
Stains with Flooded Glazes	Glaze AC	✓		✓	✓	✓	✓		✓	✓	✓	✓	✓	✓	✓	✓	✓	✓	✓	✓	✓	✓	✓	✓		✓	✓	✓	
	Glaze Combo 124	✓		✓	✓	✓	✓		✓	✓	✓	✓	✓	✓	✓	✓	✓	✓	✓	✓	✓	✓	✓	✓		✓	✓	✓	
	Glaze Combo 125	✓		✓	✓	✓	✓		✓	✓	✓	✓	✓	✓	✓	✓	✓	✓	✓	✓	✓	✓	✓	✓		✓	✓	✓	
	Glaze Combo 126	✓		✓	✓	✓	✓		✓	✓	✓	✓	✓	✓	✓	✓	✓	✓	✓	✓	✓	✓	✓	✓		✓	✓	✓	
Paints <sup>Ⓢ</sup>	Paint A	✓			✓	✓	✓	✓		✓	✓	✓	✓	✓	✓	✓	✓	✓	✓	✓	✓	✓	✓	✓	✓	✓	✓	✓	
	Paint B	✓			✓	✓	✓	✓		✓	✓	✓	✓	✓	✓	✓	✓	✓	✓	✓	✓	✓	✓	✓	✓	✓	✓	✓	
	Paint C	✓			✓	✓	✓	✓		✓	✓	✓	✓	✓	✓	✓	✓	✓	✓	✓	✓	✓	✓	✓	✓	✓	✓	✓	
	Paint F	✓			✓	✓	✓	✓		✓	✓	✓	✓	✓	✓	✓	✓	✓	✓	✓	✓	✓	✓	✓	✓	✓	✓	✓	
	Paint J	✓	✓		✓	✓	✓	✓		✓	✓	✓	✓	✓	✓	✓	✓	✓	✓	✓	✓	✓	✓	✓	✓	✓	✓	✓	
	Paint L	✓	✓		✓	✓	✓	✓		✓	✓	✓	✓	✓	✓	✓	✓	✓	✓	✓	✓	✓	✓	✓	✓	✓	✓	✓	
	Paint O <sup>NEW</sup>	✓	✓		✓	✓	✓	✓		✓	✓	✓	✓	✓	✓	✓	✓	✓	✓	✓	✓	✓	✓	✓	✓	✓	✓	✓	
	Paint Q		✓		✓	✓	✓	✓		✓	✓	✓	✓	✓	✓	✓	✓	✓	✓	✓	✓	✓	✓	✓	✓	✓	✓	✓	
	Paint AD	✓			✓	✓	✓	✓		✓	✓	✓	✓	✓	✓	✓	✓	✓	✓	✓	✓	✓	✓	✓	✓	✓	✓	✓	✓
Paint AE		✓		✓	✓	✓	✓		✓	✓	✓	✓	✓	✓	✓	✓	✓	✓	✓	✓	✓	✓	✓	✓	✓	✓	✓		
Distressing Technique	Distressing														✓ <sup>†</sup>				✓ <sup>†</sup>					✓ <sup>†</sup>					

\*Heirloom not available on Door 19, Door 21, Door 29, and Door 44.

▲In Standard construction, cabinets will have matching laminate ends. Where not available, ends will be Natural Maple laminate and a finished end treatment would be needed for an exposed end.

†Distressing not available on Paint A, Paint AD, Paint B, or Paint C.

Ⓢ Signed finish agreement required, see pages 393-396.

# FINISH AVAILABILITY

		MAPLE																												
		Matching Laminate Ends <sup>▲</sup>	Heirloom <sup>Ⓢ</sup>	Matte Sheen	Door 15	Door 16	Door 17	Door 18	Door 19	Door 21	Door 22	Door 23 <sup>NEW</sup>	Door 24 <sup>NEW</sup>	Door 26	Door 28	Door 29	Door 32	Door 34	Door 35	Door 38	Door 39	Door 41	Door 42	Door 43	Door 44	Door 45	Door 46	Door 47 <sup>NEW</sup>		
		Paints with Flooded Glazes <sup>Ⓢ</sup>	Glaze Combo 111	✓			✓	✓	✓	✓		✓	✓	✓	✓	✓	✓	✓	✓	✓	✓	✓	✓	✓	✓	✓	✓	✓	✓	✓
Glaze Combo 112	✓				✓	✓	✓	✓		✓	✓	✓	✓	✓	✓	✓	✓	✓	✓	✓	✓	✓	✓	✓	✓	✓	✓	✓	✓	
Glaze Combo 113	✓				✓	✓	✓	✓		✓	✓	✓	✓	✓	✓	✓	✓	✓	✓	✓	✓	✓	✓	✓	✓	✓	✓	✓	✓	
Glaze Combo 114	✓				✓	✓	✓	✓		✓	✓	✓	✓	✓	✓	✓	✓	✓	✓	✓	✓	✓	✓	✓	✓	✓	✓	✓	✓	
Glaze Combo 115	✓				✓	✓	✓	✓		✓	✓	✓	✓	✓	✓	✓	✓	✓	✓	✓	✓	✓	✓	✓	✓	✓	✓	✓	✓	
Glaze Combo 116	✓				✓	✓	✓	✓		✓	✓	✓	✓	✓	✓	✓	✓	✓	✓	✓	✓	✓	✓	✓	✓	✓	✓	✓	✓	✓
Glaze Combo 117	✓				✓	✓	✓	✓		✓	✓	✓	✓	✓	✓	✓	✓	✓	✓	✓	✓	✓	✓	✓	✓	✓	✓	✓	✓	✓
Glaze Combo 118	✓				✓	✓	✓	✓		✓	✓	✓	✓	✓	✓	✓	✓	✓	✓	✓	✓	✓	✓	✓	✓	✓	✓	✓	✓	✓
Glaze Combo 119	✓				✓	✓	✓	✓		✓	✓	✓	✓	✓	✓	✓	✓	✓	✓	✓	✓	✓	✓	✓	✓	✓	✓	✓	✓	✓
Glaze Combo 121	✓				✓	✓	✓	✓		✓	✓	✓	✓	✓	✓	✓	✓	✓	✓	✓	✓	✓	✓	✓	✓	✓	✓	✓	✓	✓
Glaze Combo 122	✓				✓	✓	✓	✓		✓	✓	✓	✓	✓	✓	✓	✓	✓	✓	✓	✓	✓	✓	✓	✓	✓	✓	✓	✓	✓
Glaze Combo 123	✓				✓	✓	✓	✓		✓	✓	✓	✓	✓	✓	✓	✓	✓	✓	✓	✓	✓	✓	✓	✓	✓	✓	✓	✓	✓
Distressing Technique	Distressing														✓ <sup>†</sup>				✓ <sup>†</sup>					✓ <sup>†</sup>						

\*Heirloom not available on Door 19, Door 21, Door 29, and Door 44.

▲ In Standard construction, cabinets will have matching laminate ends. Where not available, ends will be Natural Maple laminate and a finished end treatment would be needed for an exposed end.

† Distressing not available on Paint A, Paint AD, Paint B, or Paint C.

Ⓢ Signed finish agreement required, see pages 393-396.

# FINISH AVAILABILITY







		MDF			
		Door 15	Door 18	Door 19	Door 32
		Matching Laminate Ends <sup>▲</sup>			
Paints 	Paint A	✓	✓	✓	✓
	Paint B	✓	✓	✓	✓
	Paint C	✓	✓	✓	✓
	Paint F	✓	✓	✓	✓
	Paint J	✓	✓	✓	✓
	Paint L	✓	✓	✓	✓
	Paint O 	✓	✓	✓	✓
	Paint Q		✓	✓	✓
	Paint AD	✓	✓	✓	✓
	Paint AE		✓	✓	✓

▲ In Standard construction, cabinets will have matching laminate ends. Where not available, ends will be Natural Maple laminate and a finished end treatment would be needed for an exposed end.  
 Signed finish agreement required, see pages 393-396.

# FINISH AVAILABILITY

32

FINISH AVAILABILITY

		CHERRY																											
		Matching Laminate Ends <sup>▲</sup>	Heirloom <sup>*</sup> 	Matte Sheen	Door 15	Door 16	Door 17	Door 18	Door 19	Door 21	Door 22	Door 23 	Door 24 	Door 26	Door 28	Door 29	Door 32	Door 34	Door 35	Door 38	Door 39	Door 41	Door 42	Door 43	Door 44	Door 45	Door 46 	Door 47 	
Stains	Stain D	✓		✓	✓	✓	✓	✓	✓	✓	✓	✓	✓	✓	✓	✓	✓	✓	✓	✓	✓	✓	✓	✓	✓	✓	✓	✓	
	Stain E	✓		✓	✓	✓	✓	✓	✓	✓	✓	✓	✓	✓	✓	✓	✓	✓	✓	✓	✓	✓	✓	✓	✓	✓	✓	✓	
	Stain G	✓		✓	✓	✓	✓	✓	✓	✓	✓	✓	✓	✓	✓	✓	✓	✓	✓	✓	✓	✓	✓	✓	✓	✓	✓	✓	
	Stain I	✓		✓	✓	✓	✓	✓	✓	✓	✓	✓	✓	✓	✓	✓	✓	✓	✓	✓	✓	✓	✓	✓	✓	✓	✓	✓	
	Stain K	✓		✓	✓	✓	✓	✓	✓	✓	✓	✓	✓	✓	✓	✓	✓	✓	✓	✓	✓	✓	✓	✓	✓	✓	✓	✓	
	Stain M	✓		✓	✓	✓	✓	✓	✓	✓	✓	✓	✓	✓	✓	✓	✓	✓	✓	✓	✓	✓	✓	✓	✓	✓	✓	✓	
	Stain N 	✓		✓	✓	✓	✓	✓	✓	✓	✓	✓	✓	✓	✓	✓	✓	✓	✓	✓	✓	✓	✓	✓	✓	✓	✓	✓	
	Stain P	✓		✓	✓	✓	✓	✓	✓	✓	✓	✓	✓	✓	✓	✓	✓	✓	✓	✓	✓	✓	✓	✓	✓	✓	✓	✓	
	Stain T	✓		✓	✓	✓	✓	✓	✓	✓	✓	✓	✓	✓	✓	✓	✓	✓	✓	✓	✓	✓	✓	✓	✓	✓	✓	✓	✓
	Stain U	✓		✓	✓	✓	✓	✓	✓	✓	✓	✓	✓	✓	✓	✓	✓	✓	✓	✓	✓	✓	✓	✓	✓	✓	✓	✓	✓
	Stain V	✓		✓	✓	✓	✓	✓	✓	✓	✓	✓	✓	✓	✓	✓	✓	✓	✓	✓	✓	✓	✓	✓	✓	✓	✓	✓	✓
	Stain W	✓		✓	✓	✓	✓	✓	✓	✓	✓	✓	✓	✓	✓	✓	✓	✓	✓	✓	✓	✓	✓	✓	✓	✓	✓	✓	✓
	Stain X	✓		✓	✓	✓	✓	✓	✓	✓	✓	✓	✓	✓	✓	✓	✓	✓	✓	✓	✓	✓	✓	✓	✓	✓	✓	✓	✓
	Stain Y	✓		✓	✓	✓	✓	✓	✓	✓	✓	✓	✓	✓	✓	✓	✓	✓	✓	✓	✓	✓	✓	✓	✓	✓	✓	✓	✓
	Stain Z		✓	✓	✓	✓	✓	✓	✓	✓	✓	✓	✓	✓	✓	✓	✓	✓	✓	✓	✓	✓	✓	✓	✓	✓	✓	✓	✓
	Stain AA	✓		✓	✓	✓	✓	✓	✓	✓	✓	✓	✓	✓	✓	✓	✓	✓	✓	✓	✓	✓	✓	✓	✓	✓	✓	✓	✓
	Unfinished				✓	✓	✓	✓	✓	✓	✓	✓	✓	✓	✓	✓	✓	✓	✓	✓	✓	✓	✓	✓	✓	✓	✓	✓	✓
Stains with Flooded Glazes	Glaze AC	✓		✓	✓	✓	✓		✓	✓	✓	✓	✓	✓	✓	✓	✓	✓	✓	✓	✓	✓	✓	✓		✓	✓	✓	
	Glaze Combo 124	✓		✓	✓	✓	✓		✓	✓	✓	✓	✓	✓	✓	✓	✓	✓	✓	✓	✓	✓	✓	✓		✓	✓	✓	
	Glaze Combo 125	✓		✓	✓	✓	✓		✓	✓	✓	✓	✓	✓	✓	✓	✓	✓	✓	✓	✓	✓	✓	✓		✓	✓	✓	
	Glaze Combo 126	✓		✓	✓	✓	✓		✓	✓	✓	✓	✓	✓	✓	✓	✓	✓	✓	✓	✓	✓	✓	✓	✓		✓	✓	
Distressing Technique	Distressing														✓				✓					✓					





\*Heirloom not available on Door 19, Door 21, Door 29, and Door 44.

▲In Standard construction, cabinets will have matching laminate ends. Where not available, ends will be Natural Maple laminate and a finished end treatment would be needed for an exposed end.







 Signed finish agreement required, see pages 393-396.

Cherry laminate components are intentionally slightly darker than cabinet facings at the time of manufacturing to compensate for the expected darkening of doors, drawer fronts, etc., as they are exposed to natural sunlight.

# FINISH AVAILABILITY

		ALDER											RUSTIC ALDER 				
		Matching Laminate Ends <sup>▲</sup>	Heirlooming 	Matte Sheen	Door 15	Door 18	Door 31	Door 35	Door 38	Door 42	Door 47 	Door 15	Door 18	Door 31	Door 38	Door 42	Door 47 
Stains	Stain D	✓		✓	✓	✓	✓	✓	✓	✓	✓	✓	✓	✓	✓	✓	✓
	Stain E	✓		✓	✓	✓	✓	✓	✓	✓	✓	✓	✓	✓	✓	✓	✓
	Stain G	✓		✓	✓	✓	✓	✓	✓	✓	✓	✓	✓	✓	✓	✓	✓
	Stain I	✓		✓	✓	✓	✓	✓	✓	✓	✓	✓	✓	✓	✓	✓	✓
	Stain K	✓		✓	✓	✓	✓	✓	✓	✓	✓	✓	✓	✓	✓	✓	✓
	Stain M	✓		✓	✓	✓	✓	✓	✓	✓	✓	✓	✓	✓	✓	✓	✓
	Stain N 	✓		✓	✓	✓	✓	✓	✓	✓	✓	✓	✓	✓	✓	✓	✓
	Stain P	✓		✓	✓	✓	✓	✓	✓	✓	✓	✓	✓	✓	✓	✓	✓
	Stain T	✓		✓	✓	✓	✓	✓	✓	✓	✓	✓	✓	✓	✓	✓	✓
	Stain U	✓		✓	✓	✓	✓	✓	✓	✓	✓	✓	✓	✓	✓	✓	✓
	Stain V	✓		✓	✓	✓	✓	✓	✓	✓	✓	✓	✓	✓	✓	✓	✓
	Stain W	✓		✓	✓	✓	✓	✓	✓	✓	✓	✓	✓	✓	✓	✓	✓
	Stain Y	✓		✓	✓	✓	✓	✓	✓	✓	✓	✓	✓	✓	✓	✓	✓
	Stain AA	✓		✓	✓	✓	✓	✓	✓	✓	✓	✓	✓	✓	✓	✓	✓
Unfinished				✓	✓	✓	✓	✓	✓	✓	✓	✓	✓	✓	✓	✓	
Stains with Flooded Glazes	Glaze AC	✓		✓	✓	✓	✓	✓	✓	✓	✓	✓	✓	✓	✓	✓	
	Glaze Combo 124	✓		✓	✓	✓	✓	✓	✓	✓	✓	✓	✓	✓	✓	✓	
	Glaze Combo 125	✓		✓	✓	✓	✓	✓	✓	✓	✓	✓	✓	✓	✓	✓	
	Glaze Combo 126	✓		✓	✓	✓	✓	✓	✓	✓	✓	✓	✓	✓	✓	✓	
Distressing Technique	Distressing						✓	✓						✓			

<sup>▲</sup>In Standard construction, cabinets will have matching laminate ends. Where not available, ends will be Natural Maple laminate and a finished end treatment would be needed for an exposed end.  
 Signed finish agreement required, see pages 393-396.

FINISH AVAILABILITY																	
					RUSTIC HICKORY 						OAK						
		Matching Laminate Ends <sup>▲</sup>	Heirloom <sup>★</sup> 	Matte Sheen	Door 15	Door 17	Door 18	Door 28	Door 31	Door 38	Door 42	Door 15	Door 17	Door 18	Door 21	Door 24 	Door 38
Stains	Stain D	✓		✓	✓	✓	✓	✓	✓	✓	✓	✓	✓	✓	✓	✓	✓
	Stain E	✓		✓	✓	✓	✓	✓	✓	✓	✓	✓	✓	✓	✓	✓	✓
	Stain G	✓		✓	✓	✓	✓	✓	✓	✓	✓	✓	✓	✓	✓	✓	✓
	Stain I	✓		✓	✓	✓	✓	✓	✓	✓	✓	✓	✓	✓	✓	✓	✓
	Stain K	✓		✓	✓	✓	✓	✓	✓	✓	✓	✓	✓	✓	✓	✓	✓
	Stain M	✓		✓									✓	✓	✓	✓	✓
	Stain N 	✓		✓	✓	✓	✓	✓	✓	✓	✓	✓	✓	✓	✓	✓	✓
	Stain P	✓		✓	✓	✓	✓	✓	✓	✓	✓	✓	✓	✓	✓	✓	✓
	Stain T	✓		✓	✓	✓	✓	✓	✓	✓	✓	✓	✓	✓	✓	✓	✓
	Stain U 	✓		✓	✓	✓	✓	✓	✓	✓	✓	✓	✓	✓	✓	✓	✓
	Stain V	✓		✓	✓	✓	✓	✓	✓	✓	✓	✓	✓	✓	✓	✓	✓
	Stain W	✓		✓	✓	✓	✓	✓	✓	✓	✓	✓	✓	✓	✓	✓	✓
	Stain X	✓		✓	✓	✓	✓	✓	✓	✓	✓	✓	✓	✓	✓	✓	✓
	Stain Y	✓		✓	✓	✓	✓	✓	✓	✓	✓	✓	✓	✓	✓	✓	✓
	Stain AA	✓		✓	✓	✓	✓	✓	✓	✓	✓	✓	✓	✓	✓	✓	✓
Unfinished				✓	✓	✓	✓	✓	✓	✓	✓	✓	✓	✓	✓	✓	
Stains with Flooded Glazes	Glaze AC	✓		✓	✓	✓	✓	✓	✓	✓	✓						
	Glaze Combo 124	✓		✓								✓	✓	✓	✓	✓	
	Glaze Combo 125	✓		✓								✓	✓	✓	✓	✓	
Paints	Paint Q 		✓									✓	✓	✓	✓	✓	
Distressing Technique	Distressing						✓	✓									

\*Available on Oak only, not available on Door 21.

▲In Standard construction, cabinets will have matching laminate ends. Where not available, ends will be Natural Maple laminate and a finished end treatment would be needed for an exposed end.

 Signed finish agreement required, see pages 393-396.



## FINISH AVAILABILITY

DOOR COLOR AVAILABILITY		DECORATIVE LAMINATE	SPECIALTY LAMINATE		
		Door 37	Door 25	Door 33	Door 36
Non-Textured	Laminate AK	✓			✓
	Laminate AN				✓
Textured	Laminate AH			✓	
	Laminate AI	✓			✓
	Laminate AJ	✓			✓
	Laminate AL			✓	
	Laminate AM				✓
High Gloss	Laminate AF		✓		
	Laminate AG		✓		

35

CABINET COLOR AVAILABILITY		Matching Laminate Ends <sup>▲</sup>	DOOR COLOR AVAILABILITY							
			High Gloss Laminate AF / AG	Laminate AH	Laminate AI	Laminate AJ	Laminate AK	Laminate AL	Laminate AM	Laminate AN
Stains	Stain K Cherry	✓				✓				
	Stain K Maple	✓			✓	✓				
	Stain K Oak	✓			✓	✓				
	Stain M Cherry	✓				✓				
	Stain M Maple	✓				✓				
	Stain M Oak	✓				✓				
	Stain P Cherry	✓								✓
	Stain P Maple	✓								✓
	Stain P Oak	✓								✓
	Stain T Maple	✓			✓					✓
	Stain Y Maple	✓			✓					
	Stain Y Oak	✓			✓					
	Stain Z Maple	✓						✓		
Paints	Paint A	✓	✓	✓					✓	✓
	Paint C	✓		✓			✓			
	Paint F	✓		✓						✓
	Paint Q							✓		
	Paint AD	✓		✓					✓	✓

<sup>▲</sup>In Standard construction, cabinets will have matching laminate ends to match the cabinet box color. Where not available, ends will be Natural Maple laminate and a finished end treatment would be needed for an exposed end.

FINISH AVAILABILITY

## CONSTRUCTION FEATURES

	STANDARD (GSB)	PLYWOOD ENDS (PE)*	ALL-PLYWOOD CONSTRUCTION (APC)*
<b>Doors &amp; Drawer Fronts</b>	See "Door Styles" pages 10-24 for door and drawer front configuration and construction details.		
<b>Face Frames</b>	3/4" solid hardwood.		
<b>I-beam Braces</b>	3/8" furniture board dadoed into face frame, end panels and back panels.	3/8" plywood dadoed into face frame, end panels and back panels.	
<b>Cabinet Sides</b>	1/2" furniture board with Natural Maple laminate interiors. Exteriors are laminate that match the color of the face frame, with exception of Paint Q and Cherry Stain Z.	1/2" unfinished veneer plywood with Natural Maple laminate interiors.	
	Optional Furniture Finished Plywood Ends (FPEB) modification: Cabinets will have 3/4" finished veneer end panels to achieve a Furniture End appearance. See page 43 for more details.		
<b>Cabinet Tops &amp; Bottoms (Wall &amp; Tall)</b>	3/8" furniture board with Natural Maple laminate interior and exterior.	3/8" plywood with Natural Maple laminate interior and exterior.**	
<b>Cabinet Bottoms (Base &amp; Vanity)</b>	3/8" furniture board with Natural Maple laminate interior.	3/8" plywood with Natural Maple laminate interior.**	
<b>Cabinet Backs</b>	3/8" furniture board with Natural Maple laminate interior. Base cabinets have 3mm system holes for easy drawer and tray installation.	3/8" plywood with Natural Maple laminate interior.** Base cabinets have 3mm system holes for easy drawer and tray installation.	
<b>Adjustable Shelves</b>	3/4" furniture board with Natural Maple laminate to match interiors. Shelves are adjustable in wall and base cabinets unless otherwise noted.	3/4" plywood with Natural Maple laminate to match interiors.** Shelves are adjustable in wall and base cabinets.	
<b>Finish</b>	Multi-step finishing process where the finished components are sanded, stained, and sealed before a catalyzed top coat is applied.		
<b>Hinges</b>	Fully Concealed Integrated Smart Close Self Closing, 6-way Adjustable. Hinge features deactivation option. Some cabinets utilize a 170° or 107° 4-way adjustable hinge. See page 382 for details.		
<b>Drawer Box and Roll Tray Construction</b>	All Styles: Four-sided clear coated hardwood. Corners are dovetailed and glued. Drawer bottom is 5.2mm laminated plywood fully captured in box sides, front and back.		
<b>Drawer and Roll Tray Guide</b>	Double fully concealed, ball bearing, self-aligning, full extension guide with <b>smart close self-closing mechanism</b> and fast clip removal system. Smart close engages when the drawer or roll tray is approximately 2" from closing, applying resistance to the self-closing mechanism. Optional (Roll Trays): EasyTrax™ (ET) height adjustment system. All guides have a maximum weight capacity of 90 lbs. Drawers and roll trays have a maximum weight capacity of 15 lbs. per square foot.		
<b>Toekick</b>	Unfinished furniture board toekick to allow application of finished toeboard materials. A variety of laminate and wood toeboard skins and baseboard mouldings available in 8' lengths; see ACCESSORIES section. When APC is selected, toekick will be plywood.		
<b>Warranty</b>	MasterBrand Cabinets has a Limited Lifetime Warranty. For terms and conditions, please see pages 399-401.		
<b>Interior Cabinet Components</b>	A few interior components are manufactured from laminated furniture board because they provide for the most durable, aesthetic application. Some examples include the BCFW48SP (swing-out shelf), SLS33/36 (fixed shelf), and PY36 (swing-out and door mounted racks).		

### STANDARD CABINET CONSTRUCTION

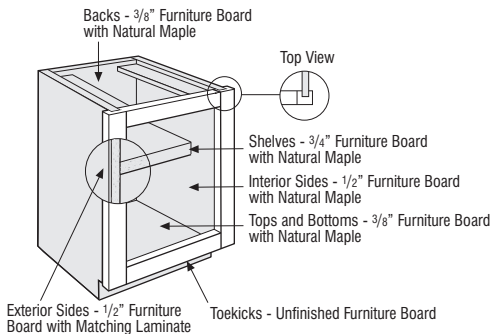

See page 38 for Plywood Ends and All-plywood Construction.

### STANDARD DRAWER CONSTRUCTION

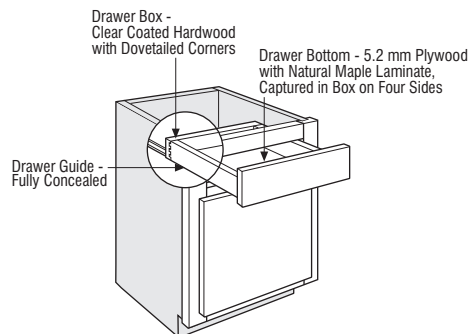

See page 38 for Plywood Ends and All-plywood Construction.

\*All-plywood components meet ANSI/HPVA HP-1 standards and may contain MDF or particleboard.

\*\*White Laminate Interior (WLI) modification is available on White cabinets to replace the Natural Maple laminate with White laminate.



# CONSTRUCTION UPGRADES

See page 37 for modification compatibility. Requests for non-published modifications may be treated as a Special Sales Order which will require feasibility, pricing and leadtime review and approval. Please check with your customer service representative before placing your order.

OPTION NAME	APPLICABLE CABINET GROUP	DESCRIPTION/LIMITATIONS
<b>Plywood Ends (PE)*</b>	Most cabinets with sides	Replaces standard cabinet ends with unfinished 1/2" plywood exterior ends. See page 36 for more details.
<b>All-plywood Construction (APC)*</b>	Most cabinets with sides	Replaces standard cabinet construction with plywood for 1/2" ends, 3/4" shelves, and 3/8" top, bottom, and back. Exterior of cabinet ends are unfinished. See page 36 for more details.  White Laminate Interior (WLI) modification available on White cabinets (painted White or Laminate) in APC, see page 44.
	Selected trim panels	Replaces standard panel material with plywood. Exterior side is finished. Interior side is Natural Maple laminate.

## PLYWOOD ENDS CONSTRUCTION UPGRADE (PE)

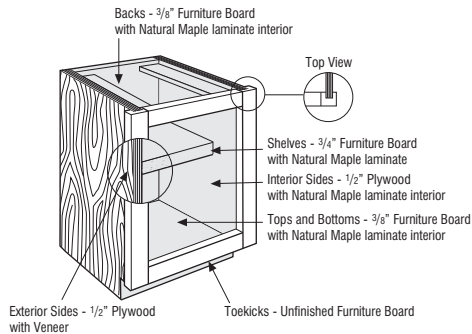

## ALL-PLYWOOD CONSTRUCTION UPGRADE (APC)

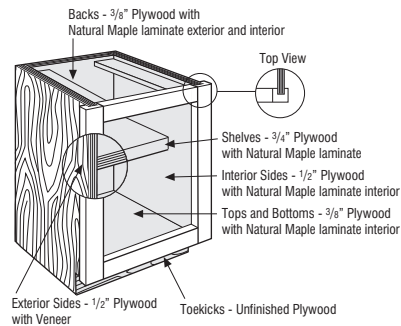

\*All-plywood components meet ANSI/HPVA HP-1 standards and may contain MDF or particleboard.

## THINGS TO REMEMBER ABOUT FINISHED ENDS AND CABINET INTERIOR FINISHES

On cabinets with PLYWOOD ENDS (PE) or ALL-PLYWOOD CONSTRUCTION (APC) modifications, cabinet sides are plywood with an unfinished veneer exterior. You can finish the exposed ends in your kitchen with one of several decorative options, as follows:

1. Leave the ends UNFINISHED if the cabinets are installed against each other or against the wall.
2. Purchase a 1/4" VENEER SKIN for field installation. This brings the cabinet side flush with the face frame.
3. Specify FURNITURE FINISHED PLYWOOD ENDS (FPEB). See page 43 for details.
4. Specify AUTHENTIC ENDS (AUTHL, AUTHR, or AUTHB) or Face Frame and Door on End (FFDL or FFDR). See page 43 for details.
5. Specify cabinets with FINISHED ENDS (FB), factory installed. Both ends of the cabinet use 1/2" plywood veneer panel that is factory finished on the exterior to match the door and frame.
6. Purchase Wall, Base or Tall END DECORATIVE DOOR PANELS (WED, BED, TED). These are a skin and a door that can be attached to finish the exposed end. This will extend the total cabinet run by the thickness of the door.
7. Purchase a Wall MESSAGE CENTER.
8. Cabinets specified with MIP have matching veneer interior and exterior. Some cabinets are provided with standard MIP construction, such as:
  - Wine Rack Cabinets
  - Bookcase Cabinets
  - Base Open Cabinets
9. All Wall Organizer and Wall/Base Spice Drawer Cabinets are frameless doweled construction and feature 3/4" furniture board with matching finished veneer interior and exterior.

# DRAWER FRONT OPTIONS

See page 37 for modification compatibility. Requests for non-published modifications may be treated as a Special Sales Order which will require feasibility, pricing and leadtime review and approval. Please check with your customer service representative before placing your order.

OPTION NAME	APPLICABLE CABINET GROUP	DESCRIPTION/LIMITATIONS
<b>Drawer Front Flat 5-piece (DFF5PC)</b>	Base, tall, and vanity cabinets on Door 16, Door 17, Door 18, Door 21, Door 22, Door 24, Door 29, Door 35, Door 38, Door 42, and Door 46	Replaces the standard drawer front with a 5-piece flat center panel drawer front (see images with applicable door styles). Premium finish and finish technique upcharges will apply where applicable. See page 81 for 5-piece drawer front dimensions when specifying decorative hardware.
<b>Drawer Front Flat 5-piece Narrow Rails (DFF5PCNR)</b>	Base, tall, and vanity cabinets on Door 15	Replaces the standard 5-piece flat center panel drawer front (2 1/4" high top and bottom rails) with a narrow rail 5-piece flat center panel drawer front (1 1/2" high top and bottom rails) (see images with applicable door styles). Not available on Door 15 Oak. Premium finish and finish technique upcharges will apply where applicable. See page 81 for 5-piece drawer front dimensions when specifying decorative hardware.
<b>Drawer Front Raised 5-piece (DFR5PC)</b>	Base, tall, and vanity cabinets on Door 31 and Door 43	Replaces the standard drawer front with a 5-piece raised center panel drawer front (see images with applicable door styles). Premium finish and finish technique upcharges will apply where applicable. See page 81 for 5-piece drawer front dimensions when specifying decorative hardware.
<b>Drawer Front Slab (DFSLB)</b>	Base, tall, and vanity cabinets on Door 15, Door 28, Door 32, Door 39, Door 41, and Door 45	Replaces the standard drawer front with a slab drawer front.

## DRAWER FRONT FLAT 5-PIECE (DFF5PC)

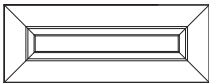

Door 16

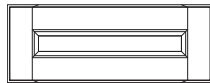

Door 29

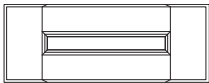

Door 17

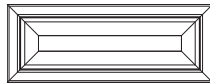

Door 35\*



Door 18



Door 38

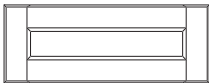

Door 21

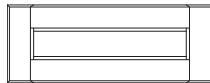

Door 42

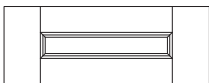

Door 22

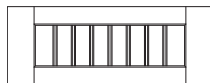

Door 46

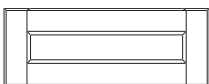

Door 24

\*Door 35 5-piece 6 1/4" and 6 3/4" high drawer fronts have a flat center panel, 10" and taller drawer fronts have a raised center panel.

## DRAWER FRONT FLAT 5-PIECE NARROW RAILS (DFF5PCNR)

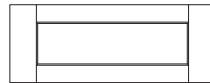

Door 15

## DRAWER FRONT RAISED 5-PIECE (DFR5PC)

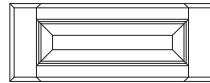

Door 31



Door 43

## DRAWER FRONT SLAB (DFSLB)



Door 15  
Door 28  
Door 32



Door 39

## DRAWER FRONT OPTIONS (cont'd)

See page 37 for modification compatibility. Requests for non-published modifications may be treated as a Special Sales Order which will require feasibility, pricing and leadtime review and approval. Please check with your customer service representative before placing your order.

OPTION NAME	APPLICABLE CABINET GROUP	DESCRIPTION/LIMITATIONS
<b>Drawer Front Flat 5-piece with Slab Top (DFF5PCSLBT)</b>	Base, tall, and vanity cabinets on Door 16, Door 17, Door 18, Door 21, Door 22, Door 24, Door 29, Door 35, Door 38, Door 42, and Door 46	<p>Replaces the standard slab drawer fronts with a 5-piece flat center panel drawer front with the exception of the top drawer front of base and vanity cabinets when the face frame opening is 5" high, which will remain slab (see images with applicable door styles). Drawer front will be slab on Tall Built-in Microwave (TBMWB..) and Single Oven Cabinets (OSB..).</p> <p>Not available on Wall Two Drawer (W2D..) and Furniture Drawer 6 3/4" High (FD..6.75..). Use DFF5PC for a 5-piece drawer front on these cabinets where DFF5PCSLBT is not available.</p> <p>Not compatible with Inverted Frame (INVERM) modification.</p> <p>Upcharge for 5-piece drawer front is not applied to slab drawer fronts.</p> <p>Premium finish and finish technique upcharges will apply where applicable.</p> <p>See page 81 for 5-piece drawer front dimensions when specifying decorative hardware.</p>
<b>Drawer Front Flat 5-piece Narrow Rails with Slab Top (DFF5PCNRST)</b>	Base, tall, and vanity cabinets on Door 15	<p>Replaces the standard 5-piece flat center panel drawer front (2 1/4" high top and bottom rails) with a narrow rail 5-piece flat center panel drawer front (1 1/2" high top and bottom rails) with the exception of the top drawer front of base and vanity cabinets when the face frame opening is 5" high, which will be slab (see images with applicable door styles). Drawer front will be slab on Tall Built-in Microwave (TBMWB..) and Single Oven Cabinets (OSB..).</p> <p>Not available on Wall Two Drawer (W2D..) and Furniture Drawer 6 3/4" High (FD..6.75..). Use DFF5PCNR for a 5-piece drawer front on these cabinets where DFF5PCNRST is not available.</p> <p>Not available on Door 15 Oak.</p> <p>Not compatible with Inverted Frame (INVERM) modification.</p> <p>Upcharge for 5-piece drawer front is not applied to slab drawer fronts.</p> <p>Premium finish and finish technique upcharges will apply where applicable.</p> <p>See page 81 for 5-piece drawer front dimensions when specifying decorative hardware.</p>

**DRAWER FRONT FLAT 5-PIECE WITH SLAB TOP (DFF5PCSLBT)**

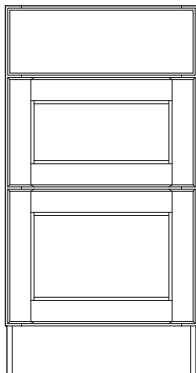

**DRAWER FRONT FLAT 5-PIECE NARROW RAILS WITH SLAB TOP (DFF5PCNRST)**

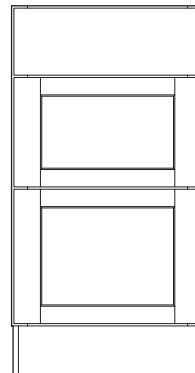

## DRAWER FRONT OPTIONS (cont'd)

See page 37 for modification compatibility. Requests for non-published modifications may be treated as a Special Sales Order which will require feasibility, pricing and leadtime review and approval. Please check with your customer service representative before placing your order.

OPTION NAME	APPLICABLE CABINET GROUP	DESCRIPTION/LIMITATIONS
<b>Drawer Front Raised 5-piece with Slab Top (DFR5PCSLBT)</b>	Base, tall, and vanity cabinets on Door 31 and Door 43	<p>Replaces the standard slab drawer fronts with a 5-piece raised center panel drawer front with the exception of the top drawer front of base and vanity cabinets when the face frame opening is 5" high, which will remain slab (see images with applicable door styles). Drawer front will be slab on Tall Built-in Microwave (TBMWB..) and Single Oven Cabinets (OSB..).</p> <p>Not available on Wall Two Drawer (W2D..) and Furniture Drawer 6 3/4" High (FD..6.75..). Use DFR5PC for a 5-piece drawer front on these cabinets where DFR5PCSLBT is not available.</p> <p>Not compatible with Inverted Frame (INVFRM) modification.</p> <p>Upcharge for 5-piece drawer front is not applied to slab drawer fronts.</p> <p>Premium finish and finish technique upcharges will apply where applicable.</p> <p>See page 81 for 5-piece drawer front dimensions when specifying decorative hardware.</p>
<b>Drawer Front Slab Top (DFSLBT)</b>	Base, tall, and vanity cabinets on Door 15, Door 28, Door 32, Door 39, Door 41, and Door 45	<p>Replaces the 5-piece top drawer front of base and vanity cabinets with a slab drawer front when the face frame opening is 5" high. The remaining drawer fronts will remain 5-piece (see images with applicable door styles). Drawer front will be slab on Tall Built-in Microwave (TBMWB..) and Single Oven Cabinets (OSB..).</p> <p>Not available on Wall Two Drawer (W2D..) and Furniture Drawer 6 3/4" High (FD..6.75..).</p> <p>Not compatible with Inverted Frame (INVFRM) modification.</p> <p>Premium finish and finish technique upcharges will apply where applicable.</p> <p>See page 81 for 5-piece drawer front dimensions when specifying decorative hardware.</p>

**DRAWER FRONT RAISED 5-PIECE WITH SLAB TOP (DFR5PCSLBT)**

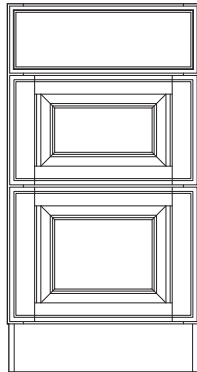

**DRAWER FRONT SLAB TOP (DFSLBT)**

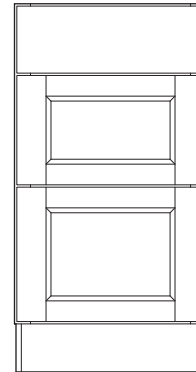

# DRAWER AND DOOR OPTIONS

See page 37 for modification compatibility. Requests for non-published modifications may be treated as a Special Sales Order which will require feasibility, pricing and leadtime review and approval. Please check with your customer service representative before placing your order.

OPTION NAME	APPLICABLE CABINET GROUP	DESCRIPTION/LIMITATIONS
<b>Door Panel - Solid Reverse Raised (DPSRR)</b>	Most cabinets with doors and most panels with doors; AUTHL, AUTHR, AUTHB, FFDL, and FFDR modifications; available on Door 15, Door 16, Door 17, Door 22, Door 23, Door 32, Door 34, Door 39, Door 41, Door 45, and Door 47	Replaces veneer flat door center panel with a solid reverse raised center panel. Not available on Door 15 MDF or Door 32 MDF. Drawer fronts are not affected by this door option. When ordered in Maple, center panels in Paint and Paint with Glaze finishes will be reverse raised MDF.
<b>Modified Full Overlay (MFO)</b>	Most wall and tall cabinets and some panels with doors	Reduces the size of a Full Overlay door by 3/4" allowing for a top face frame reveal of 1" to allow for face mount moulding application. Overlay Fillers are available in MFO heights to align with doors, see pages 303-306 for OL..MFO and OL..MFOP. Not compatible with Add Toekick modification. When Authentic End(s) are ordered in conjunction with Modified Full Overlay, the Authentic End will match the face frame reveal. Not available on Aluminum Frame Doors. Not available on Door 37, Door 44, Door 15 MDF, Door 18 MDF, and Door 32 MDF.
<b>Scooped Drawer (SCPDRW) (SCPDRWB) (SCPDRWL) (SCPDRWR)</b>	Most base cabinets	Replaces top drawer box with a 2" high drawer box to allow for clearance of cooktops, etc. Only top drawer will be modified when specified on drawer bases. On base cabinets with two top drawers, L, R, or B must be specified. Increases clearance for cooktops from 2 1/2" to 3 7/8". When SCPDRW is selected on 2DB18-2DB42, top drawer will utilize a 6 3/8" high drawer box, creating a clearance of 6 5/8" for the cooktop. Not available on MDF or Door 37 door styles.

## DOOR PANEL - SOLID REVERSE RAISED (DPSRR)

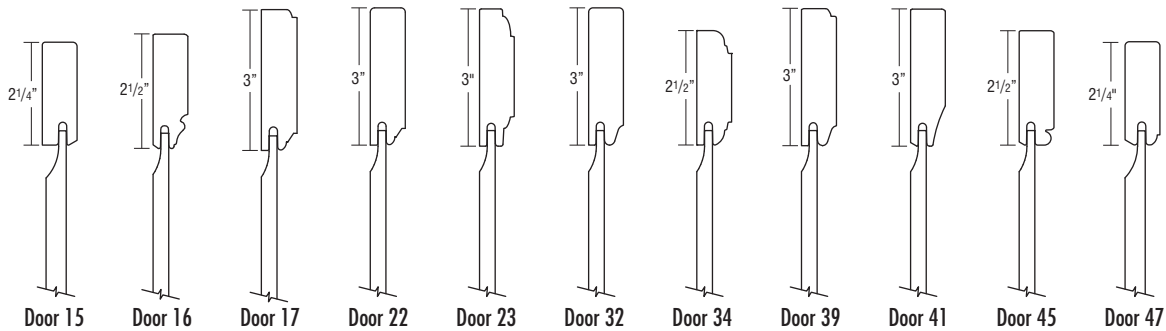

## MODIFIED FULL OVERLAY (MFO)

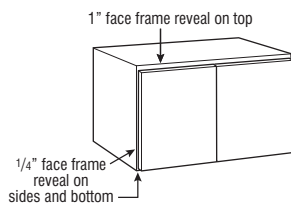

## SCOOPED DRAWER (SCPDRW/SCPDRWB/SCPDRWL/SCPDRWR)

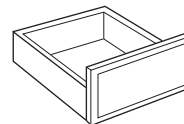



# END PANEL MODIFICATIONS

See page 37 for modification compatibility. Requests for non-published modifications may be treated as a Special Sales Order which will require feasibility, pricing and leadtime review and approval. Please check with your customer service representative before placing your order.

OPTION NAME	APPLICABLE CABINET GROUP	DESCRIPTION/LIMITATIONS
<b>Authentic Ends (AUTHL) (AUTHR) (AUTHB)</b>	Most wall, base, tall, and vanity cabinets	<p>Modifies cabinet end panel(s) with applied decorative door(s) onto FPEB upgraded end panel(s).</p> <p>Includes FPEB modification — If AUTHL or AUTHR upgrades are specified, the opposite end panel is also FPEB.</p> <p>Available on most cabinets with depths of 9", 12", 15", 18", 21", 24" and 27". Custom doors must be specified for other depths not listed. 9" depth available on cabinets 30" high or taller.</p> <p>For tall cabinets, non-miter doors have two panels on the bottom door.</p> <p>27" deep cabinets will have double door configuration. Office base cabinets (29" high) will have double door configuration when specified on 24" deep cabinets.</p> <p>DPSRR option and upcharge applies to Authentic End door(s), which will be upgraded to a solid reverse raised center panel.</p>
<b>Face Frame and Door on End (FFDL) (FFDR)</b>	Most wall, base, tall, and vanity cabinets	<p>Creates a working door on the end of the specified cabinet. Side cabinet configuration will match front cabinet configuration (i.e. drawer/door or full height door). Opposite end panel will be FPEB. Side cabinet configuration will match front configuration.</p> <p>On Base and Tall cabinets, recessed toe space is standard on the side specified with FFDR or FFDL (if any flush toekick modification is specified, FFD side of cabinet will also be flush). 12" deep cabinets specified with FFDL or FFDR and FTKAV or FTKFV will receive a standard flush toekick.</p> <p>Full depth shelves standard. Glass shelves not compatible with the FFD modification.</p> <p>Doors will always be hinged on the back of the cabinet. Option not available on both ends of cabinet. Not available on peninsula cabinets. Available on cabinets in depths of 12", 15", 18", 21", and 24".</p> <p>CG, MD, and DPSRR options and upcharges apply to FFD door. When MD is selected on 12" deep cabinets, the FFD door will be CG. When ordered with Mullion Doors on 39" or 42" high cabinets, adjustable shelves will not align with mullions.</p>
<b>Finished Ends (FB)</b>	Cabinets with PE or APC modification; both ends will be finished	Creates a matching finished 1/2" veneer plywood exterior.
<b>Furniture Finished Plywood* Ends (FPEB)</b>	Most wall, base, tall, office, and vanity cabinets	Replaces standard cabinet ends with 3/4" finished veneer end panels to achieve a Furniture End appearance. Both exterior sides are finished. Includes PE upgrade and standard laminate interior. Matching Interior Plywood (MIP) is available.

## AUTHENTIC ENDS (AUTHL/AUTHR/AUTHB)

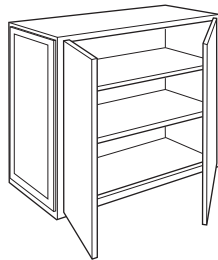

Wall cabinets

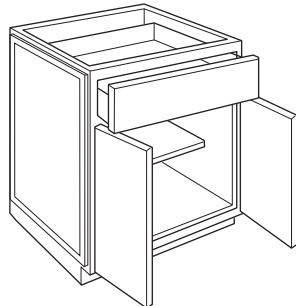

Base and Vanity cabinets

## FURNITURE FINISHED PLYWOOD ENDS (FPEB)

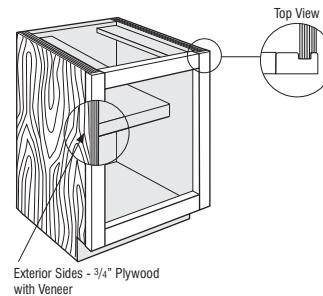

## FACE FRAME AND DOOR ON END (FFDL/FFDR)



Wall cabinets

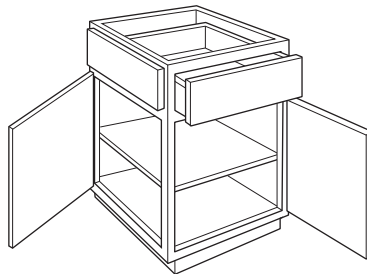

Base cabinets

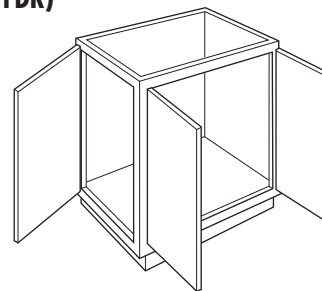

Vanity cabinets



\*All-plywood components meet ANSI/HPVA HP-1 standards and may contain MDF or particleboard.

# FINISH MODIFICATIONS

See page 37 for modification compatibility. Requests for non-published modifications may be treated as a Special Sales Order which will require feasibility, pricing and leadtime review and approval. Please check with your customer service representative before placing your order.

OPTION NAME	APPLICABLE CABINET GROUP	DESCRIPTION/LIMITATIONS
<b>Matching Interior Plywood (MIP)</b>	Most cabinets	<p>Modifies the cabinet interior and end panel exterior to matching finished veneer plywood. Cabinet top and bottom exterior on wall cabinets is also matching finished veneer plywood.</p> <p>Cabinet construction features 1/2" plywood ends and 3/8" top, bottom, and back. Shelves are upgraded to full depth 3/4" veneered plywood.</p> <p>Interior wood accessories feature a natural finish and will not match cabinet exterior.</p> <p>When a decorative door option is chosen in 20/20, Matching Interior Plywood (MIP) is a preselected option. If MIP is not desired, it can be deselected by choosing NOTMIP.</p>
	Most end panels with fillers attached	Replaces standard panel material with veneer plywood finished on both sides.
<b>White Laminate Interior (WLI)</b>	White cabinets with APC	<p>Replaces Natural Maple laminate interior with White laminate plywood interior. Wall cabinet exterior tops and bottoms will be white laminate. PFINBTMB is recommended for use when WLI cabinets are adjacent to cabinets with natural maple laminate cabinet bottoms. Finished Ends (FB) is recommended for matching finished veneer ends.</p> <p>Only available on cabinets in White (painted Maple or Laminate) that are specified with APC.</p> <p>WLI shelves are plywood with White laminate, interior accessories will not change.</p>

## MATCHING INTERIOR PLYWOOD (MIP)

-  matching finished veneer
-  standard matching finished component
-  standard non-matching finished component

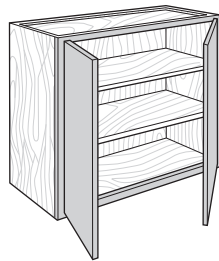

Wall cabinets

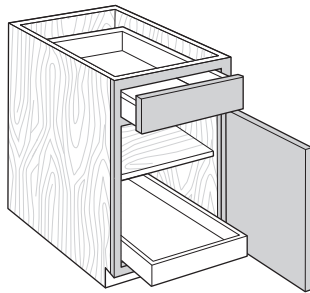

Base cabinets

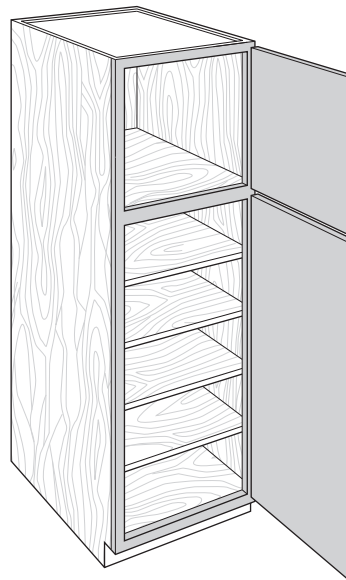

Tall cabinets

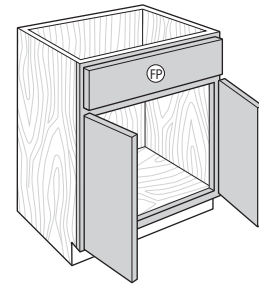

Vanity cabinets

## WHITE LAMINATE INTERIOR (WLI)

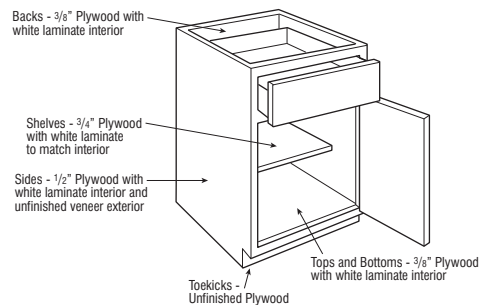

# BOX MODIFICATIONS

See page 37 for modification compatibility. Requests for non-published modifications may be treated as a Special Sales Order which will require feasibility, pricing and leadtime review and approval. Please check with your customer service representative before placing your order.

OPTION NAME	APPLICABLE CABINET GROUP	DESCRIPTION/LIMITATIONS
<b>Cabinet Box Only (CBO)</b>	Most wall, base, tall, and vanity cabinets	Removes doors, drawer fronts, and any accessory items attached to a door or drawer front. Drawer box and any interior components attached to the cabinet box will be included. Frames will not be drilled for hinges.
<b>Cabinet Case Only (CCO)</b>	Most wall, base, tall, and vanity cabinets	Removes doors, drawer fronts, drawer boxes, interior components, and mini touch-up kits. Frames will not be drilled for hinges, but cabinet will have standard drilling for shelves and guides.
<b>Cabinet False Panel (CFP)</b>	Most base and vanity cabinets with a top drawer	Replaces top drawer with false panel. Not available with deep drawers.
<b>Cabinet with No Door, with Drawer (CND)</b>	Most wall, base, tall, and vanity cabinets with door(s) and drawer(s)	Removes door(s). Complete drawer(s) with drawer front(s) and interior components remain in cabinet. Frames will not be drilled for hinges.

### CABINET BOX ONLY (CBO)

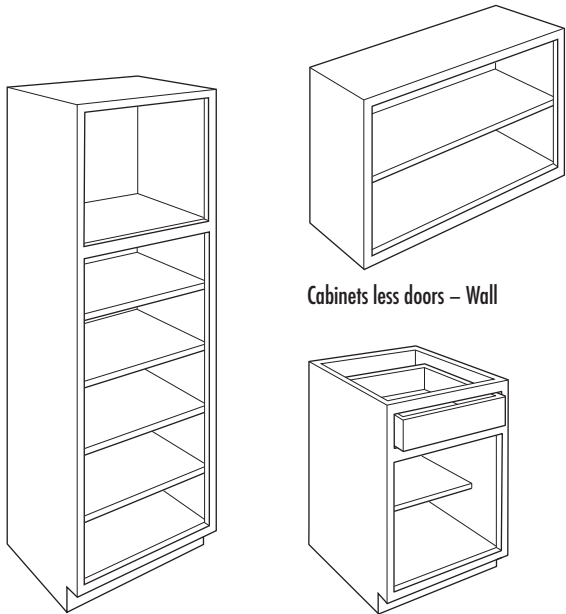

Cabinets less doors – Tall

Cabinets less doors and drawer fronts – Base

### CABINET CASE ONLY (CCO)

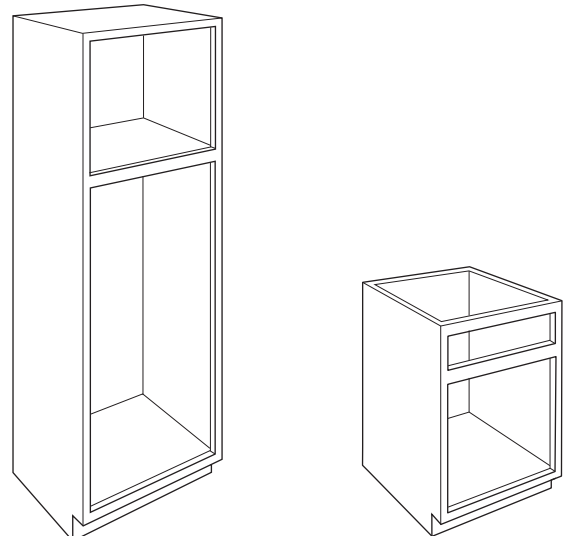

Cabinet case only – Tall

Cabinet case only – Base

### CABINET FALSE PANEL (CFP)

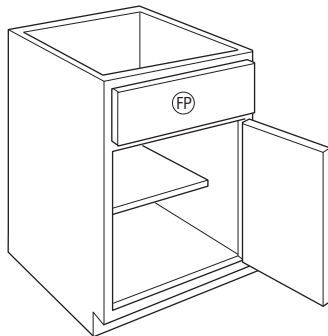

Base and Vanity cabinets

### CABINET WITH NO DOOR, WITH DRAWER (CND)

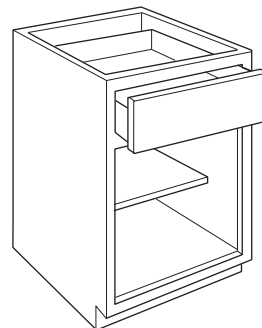

Base and Vanity cabinets

## BOX MODIFICATIONS (cont'd)

See page 37 for modification compatibility. Requests for non-published modifications may be treated as a Special Sales Order which will require feasibility, pricing and leadtime review and approval. Please check with your customer service representative before placing your order.

OPTION NAME	APPLICABLE CABINET GROUP	DESCRIPTION/LIMITATIONS
<b>Increased Depth (ID)</b>	Most wall and vanity cabinets	Increases the depth of wall and vanity cabinets in 1" increments to a maximum depth of 27". Increased depth wall cabinets should be either floor mounted or stacked to maintain stability. Any specified shelving is included and is always full depth. Wall peninsula cabinets may be increased in 1" increments to 18" maximum. Depth restrictions may apply where depths are available as a standard cabinet. Wall cabinets 12" deep are limited to up to 15" deep on sizes where a 24" deep cabinet is available.
	Most base, tall, and vanity cabinets without drawers or roll trays	Increases the depth of base, tall, and vanity cabinets without drawers or roll trays in 1" increments to 27". When depth beyond 24" is desired on tall cabinets, the 24" deep cabinet must be modified. Any specified shelving is included and is always full depth. Depth restrictions may apply where depths are available as a standard cabinet.
	Oven Cabinets	Increases the depth of oven cabinets in 1" increments to a maximum depth of 27". When oven cabinets with drawers are increased, drawer depth will not change. Any specified shelving is included and is always full depth.
	End panels	Increases the depth of end panels in 1" increments to a maximum depth of 36". 31"-36" depths available on plywood panels only. AEL/AER panels are only available in 3" increments up to a maximum depth of 36".
<b>Reduced Depth (RD)</b>	Most base, tall, and vanity cabinets with drawers or roll trays	Reduces the depth in 1" increments to a minimum depth of 12". Any specified shelving is included and is always full depth. The dimension is specified as the distance from the front of the face frame to the back of the cabinet.
	Most base, tall, and vanity cabinets without drawers or roll trays	Reduces the depth in 1" increments to a minimum depth of 6". If reduced depth to 8" or less, toekick will not be included. Any specified shelving is included and is always full depth. The dimension is specified as the distance from the front of the face frame to the back of the cabinet.
	Most wall cabinets	Reduces the depth in 1" increments to a minimum depth of 6". Any specified shelving is included and is always full depth. The dimension is specified as the distance from the front of the face frame to the back of the cabinet. Wall top hinge cabinets can only be reduced to 9" depth minimum.
	End panels	Reduces the depth in 1" increments to a minimum depth of 6".
	Roll tray kits	Reduces the depth in 1" increments to fit a minimum cabinet depth of 12".

Cabinet Depth	Drawer Box and Roll Tray Exterior Depth		Clearance Behind Drawer Box or Roll Tray and Back Panel	
	Standard Drawer Guides	Heavy Duty Side-mount Guides (DDFD)	Standard Drawer Guides	Heavy Duty Side-mount Guides (DDFD)
24	21	21	2 3/4	2 3/4
23	21	18	1 3/4	4 3/4
22	18	18	3 3/4	3 3/4
21	18	18	2 3/4	2 3/4
20	18	N/A	1 3/4	N/A
19	15	N/A	3 3/4	N/A
18	15	N/A	2 3/4	N/A
17	15	N/A	1 3/4	N/A
16	12	N/A	3 3/4	N/A
15	12	N/A	2 3/4	N/A
14	12	N/A	1 3/4	N/A
13	9	N/A	3 3/4	N/A
12	9	N/A	2 3/4	N/A

### INCREASED DEPTH (ID)

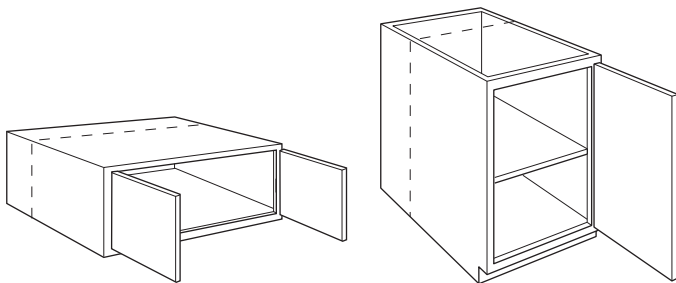

Wall cabinets

Base cabinets

### REDUCED DEPTH (RD)

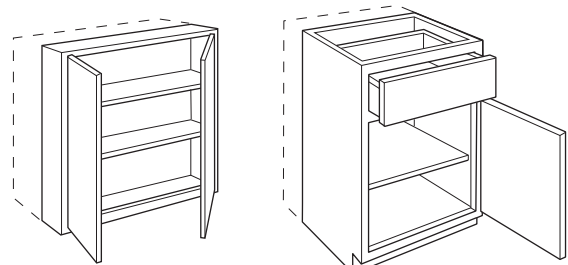

Wall cabinets

Base cabinets

## BOX MODIFICATIONS (cont'd)

See page 37 for modification compatibility. Requests for non-published modifications may be treated as a Special Sales Order which will require feasibility, pricing and leadtime review and approval. Please check with your customer service representative before placing your order.

OPTION NAME	APPLICABLE CABINET GROUP	DESCRIPTION/LIMITATIONS
<b>End Extended Back (EXBKL) (EXBKR)</b>	Most cabinets	<p>Extends cabinet end panel back in 1" increments, available up to 6" per side. Includes FPEB modification with 3/4" finished veneer end panels on both ends.</p> <p>EXBKL and EXBKR are compatible with each other and can be specified with either the same dimension per side or unique dimensions if desired. Compatible with Authentic Ends when End Extended Back is specified in 3" increments.</p>
<b>Prepare Cabinet for Finished Bottom (PFINBTMB)</b>	Most wall cabinets	<p>Prepares cabinet for installation of a separately purchased and field installed applied 1/4" end panel skin to create a flush finished bottom on a single cabinet or multiple cabinets that are bridged between taller adjacent cabinets.</p> <p>Features factory installed spacer blocks against the cabinet bottom, along the face frame, back, and end panels. Cabinet back and end panel heights are 1/4" less than the face frame, leaving clearance for the applied skin. Cabinet end panel bottom edge remains unfinished.</p> <p>Panel utilized for flush bottom must be purchased separately using 1/4" end panel skins (see WEPS __, TEPS __, or BEPS __ on pages 313-314) or 1/4" custom panels (see DAPNL1/4 on page 326), and requires cabinet installer to cut to size before installation.</p> <p>If used on the end of a run, moulding or a full height end panel skin must be purchased separately to cover exposed unfinished edge of applied skin for the flush finished bottom. Not compatible with FPEB, AUTHL/AUTHR/AUTHB, FFDL/FFDR, and EXBKL/EXBKR modifications.</p>

**END EXTENDED BACK LEFT (EXBKL)**

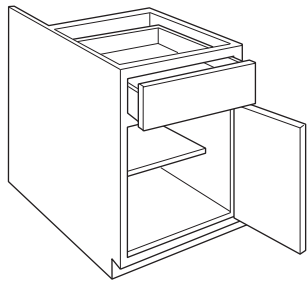

**END EXTENDED BACK RIGHT (EXBKR)**

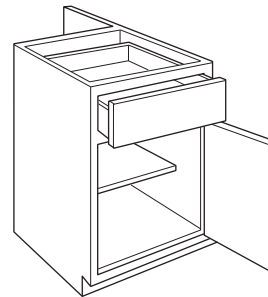

**PREPARE CABINET FOR FINISHED BOTTOM (PFINBTMB)**

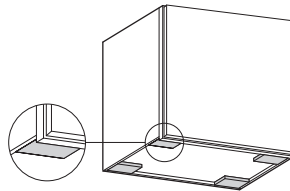

# FACE FRAME MODIFICATIONS

See page 37 for modification compatibility. Requests for non-published modifications may be treated as a Special Sales Order which will require feasibility, pricing and leadtime review and approval. Please check with your customer service representative before placing your order.

OPTION NAME	APPLICABLE CABINET GROUP	DESCRIPTION/LIMITATIONS
<b>Appliance Cut-out, Single (ACS)</b>	Most Oven Cabinets	Creates a custom cut-out area for field-ready oven installation. Available on oven cabinets specified with an (N) for Narrow Stile, with 1 1/2" wide frame side stiles. See cabinet specifications for available cut-out dimensions. Custom Width dimension available in 1/4" increments, with a minimum of 1/2" to a maximum of 6" less than the cabinet width. Frame side stiles will not be notched. Custom Height dimension available in 1/4" increments. Cut-out area will be centered.
<b>Extended Stile (EXL) (EXR)</b>	Most cabinets with a face frame	Extends face frame width beyond its normal width by specified dimension to eliminate the need for field installed fillers, available in 1/2" increments from 1/2"-3". For example, a 1 1/2" wide face frame with EXL2 will have a width of 3 1/2" on the left side of the cabinet. Extended Left: EXL.5, EXL1, EXL1.5, EXL2, EXL2.5, EXL3 Extended Right: EXR.5, EXR1, EXR1.5, EXR2, EXR2.5, EXR3 EXL and EXR are compatible with each other and can be specified with either the same dimension per side or unique dimensions if desired. When ordered with Peninsula (P) modification, both face frames on specified side will be modified.

## APPLIANCE CUT-OUT, SINGLE (ACS)

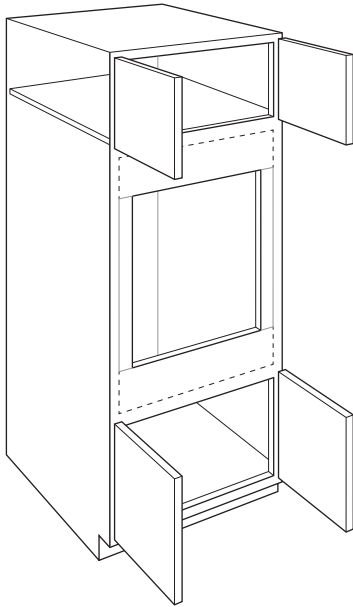

## EXTENDED STILE LEFT (EXL)

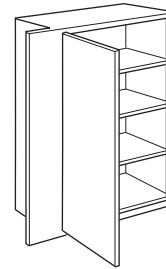

Cabinets with a face frame – Wall

## EXTENDED STILE RIGHT (EXR)

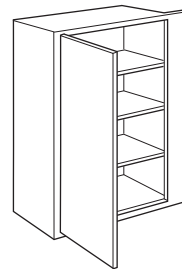

Cabinets with a face frame – Wall

## FACE FRAME MODIFICATIONS (cont'd)

See page 37 for modification compatibility. Requests for non-published modifications may be treated as a Special Sales Order which will require feasibility, pricing and leadtime review and approval. Please check with your customer service representative before placing your order.

OPTION NAME	APPLICABLE CABINET GROUP	DESCRIPTION/LIMITATIONS
<b>Inverted Frame (INVFRM)</b>	Most cabinets with a face frame cross rail  Tall Panels with Filler Attached and Authentic Ends	Inverts face frame openings. Drawer openings relocated to the bottom of a base cabinet must always be a working drawer. Opening sizes for doors do not change, standard drawer opening changes to 4 1/2" high.  On talls and stacked walls, when INVFRM is ordered in conjunction with CG (Cut-for-glass), top and bottom locations should be specified after the frame is inverted. Glass only available on doors for 41 1/2" high or less.  Doors on inverted frame cabinets may not align with adjacent cabinet doors.  On Tall Panels with Filler Attached and Authentic Ends, when INVFRM is selected, doors will be inverted (no face frame) to align with tall cabinets with the modification.
<b>Valance Top Rail (TVRAV) (TVRFV) (TVRVV)</b>	Base Open Cabinets, Bookcases	Modifies the top rail with an arch, furniture, or straight valance.

### INVERTED FRAME (INVFRM)

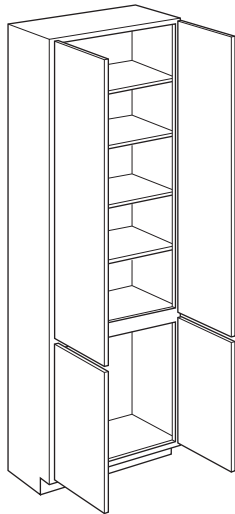

Tall cabinets

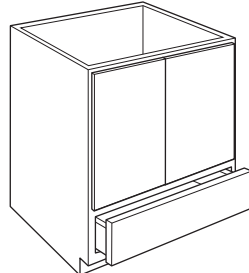

Base cabinets

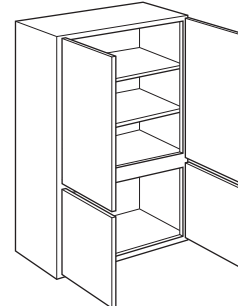

Wall cabinets

#### VALANCE TOP RAIL, ARCH (TVRAV)

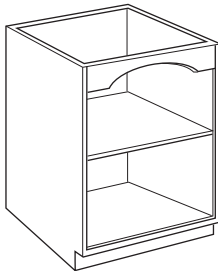

#### VALANCE TOP RAIL, FURNITURE (TVRFV)

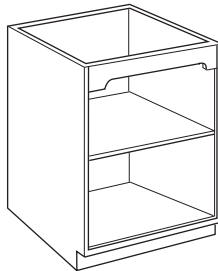

#### VALANCE TOP RAIL, STRAIGHT (TVRVV)

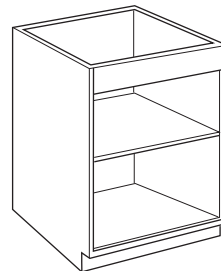

# INSTALLED INTERIOR MODIFICATIONS

See page 37 for modification compatibility. Requests for non-published modifications may be treated as a Special Sales Order which will require feasibility, pricing and leadtime review and approval. Please check with your customer service representative before placing your order.

OPTION NAME	APPLICABLE CABINET GROUP	DESCRIPTION/LIMITATIONS
<b>Secured Drawer featuring Master Lock Biometric Technology (DRWSEC) (DRWSECB) (DRWSECL) (DRWSECR)</b>	Most base cabinets with a top drawer	<p>Modifies the standard drawer box with an installed self-locking mechanism featuring proven Master Lock advanced sensor biometric technology. When activated, drawer opens 2 3/16" to access fingerprint reader, which stores up to 100 unique fingerprints. Homeowner must reset memory after cabinet installation. Secured housing protrudes 2 3/4" into the depth of the drawer box interior.</p> <p>Features one 9V battery compartment (battery not included). Self-locking when in closed position. Manual key lock on bottom of drawer for backup method of entry.</p> <p>DRWSEC available on 24" deep base cabinets with widths of 18", 21", and 24".</p> <p>DRWSECL, DRWSECR, and DRWSECB available on 24" deep base cabinets with widths of 42" and 48".</p> <p>Not compatible with Reduced Depth (RD) modification or PowerGlide™ Compact Drawer Outlet (DRWPWR).</p> <p>Installer must remove the drawer front to drill and countersink the back of the drawer front for field installation of knobs and pulls.</p>
<b>CabMat™ (CMAT1) (CMAT2)</b>	Most sink base and vanity cabinets	<p>Installs removable CabMat™, size is determined by face frame opening width and cabinet depth.</p> <p>CMAT2 is only available on vanity cabinets designed for double bowl applications.</p> <p>Not available with Reduced Depth modification. When ordered with Increased Depth modification, CabMat™ size does not change.</p> <p>Vanity cabinets with face frame openings of 24" and 30" will utilize CabMat™ sized for 21" and 27" openings.</p> <p>See page 371 for CabMat™ product descriptions.</p>
<b>Full Depth Shelf (FD)</b>	Base cabinets with standard half depth shelves	Replaces standard shelf with full depth shelf.

## SECURED DRAWER FEATURING MASTER LOCK BIOMETRIC TECHNOLOGY (DRWSEC/DRWSECB/DRWSECL/DRWSECR)

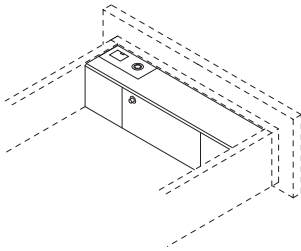

## FULL DEPTH SHELF (FD)

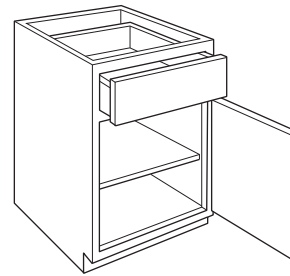

## CABMAT™ (CMAT1/CMAT2)

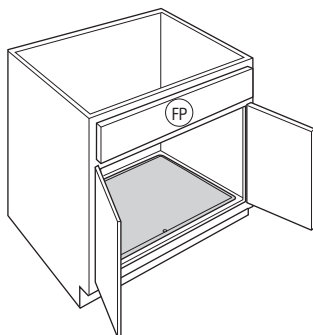

Base cabinets (CMAT1)

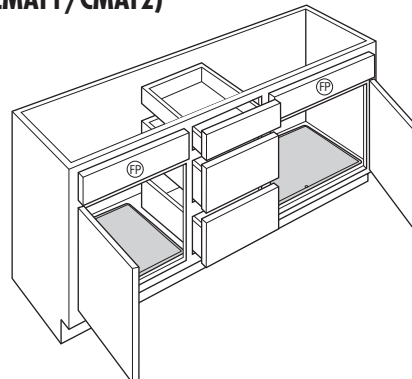

Vanity cabinets with double bowl (CMAT2)



## INSTALLED INTERIOR MODIFICATIONS (cont'd)

See page 37 for modification compatibility. Requests for non-published modifications may be treated as a Special Sales Order which will require feasibility, pricing and leadtime review and approval. Please check with your customer service representative before placing your order.

OPTION NAME	APPLICABLE CABINET GROUP	DESCRIPTION/LIMITATIONS
<b>Deep Roll Tray (DRT)</b>	Most cabinets with roll trays	Replaces standard roll trays with a 6 3/8" deep roll tray. Replaces bottom roll tray only on base cabinets and bottom 2 roll trays on utility cabinets.
<b>EasyTrax™ (ET)</b>	Most cabinets with roll trays	Includes pre-installed upright wooden system that allows for easy height adjustment of roll trays.
<b>Installed Roll Tray (RT)</b>	Select base, tall, office, and vanity cabinets	<p>Installs specified number of roll trays (1-5 per side). Example, for two roll trays, specify 2RT.</p> <p>On cabinets with center stile, specify RTL for roll trays in left side and RTR for roll trays in right side. RTL and RTR should be selected for roll trays in both sides.</p> <p>When 1RT is specified on a base cabinet, the roll tray is installed in the lowest position and one half depth adjustable shelf is included. On utility cabinets for lower section, 1RT includes three shelves, 2RT includes two shelves, and 3RT includes 1 shelf. No shelves for lower section are included with 4RT or 5RT.</p>
<b>Light Installed Battery Strip (LTI.BS) (LTI.BSB) (LTI.BSL) (LTI.BSR)</b>	Select base, office, and vanity cabinets	<p>Installs a battery operated LED light inside the cabinet door opening(s).</p> <p>LTI.BS installs one LED light inside the cabinet door opening.</p> <p>LTI.BSB installs two LED lights inside both left and right cabinet door openings. On corner cabinets, installs one LED light for the top section and one LED light below fixed shelf for bottom section.</p> <p>LTI.BSL installs one LED light in the left door opening.</p> <p>LTI.BSR installs one LED light in the right door opening.</p> <p>Battery operated - (4) AAA batteries (not included). Motion activated. Low power usage (0.3W). Plastic aluminum finish. Dimensions: Length 11.93" (303mm), Width 0.67" (17mm), and Depth 0.55" (14mm).</p>

### DEEP ROLL TRAY (DRT)

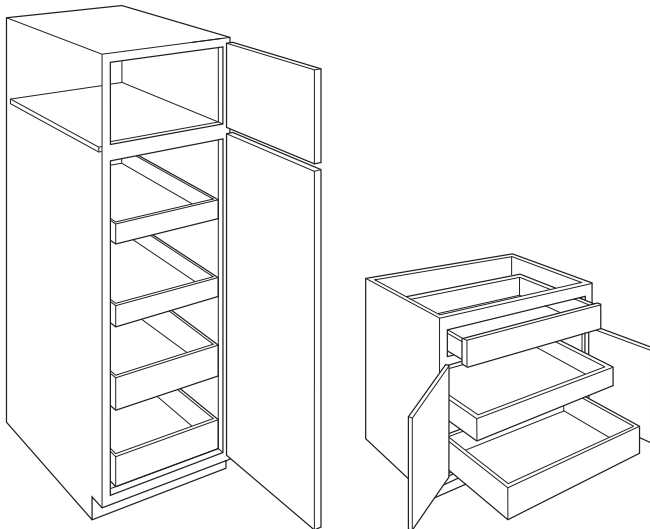

Tall cabinets

Base cabinets

### INSTALLED ROLL TRAY (RT)

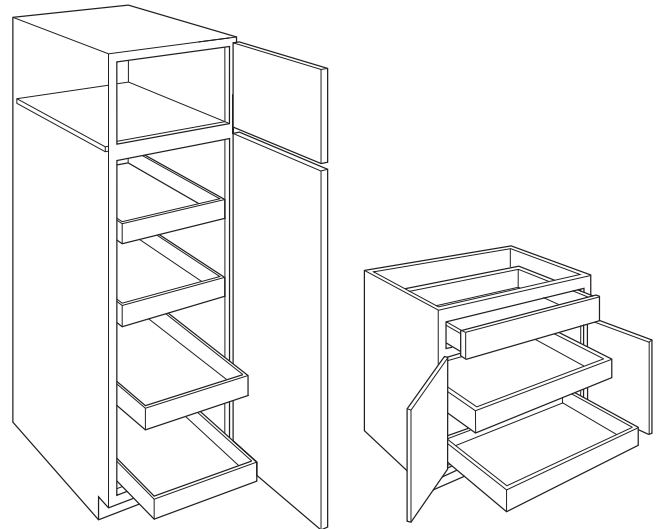

Tall cabinets

Base, Office, and Vanity cabinets

### LIGHT INSTALLED BATTERY STRIP (LTI.BS/LTI.BSB/LTI.BSL/LTI.BSR)

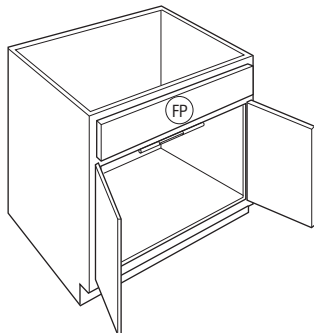

Base cabinet (LTI.BS)

### EASYTRAX™ (ET)

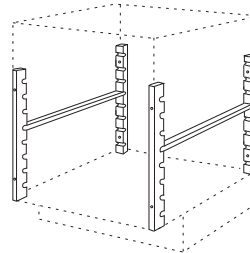

## INSTALLED INTERIOR MODIFICATIONS (cont'd)

See page 37 for modification compatibility. Requests for non-published modifications may be treated as a Special Sales Order which will require feasibility, pricing and leadtime review and approval. Please check with your customer service representative before placing your order.

OPTION NAME	APPLICABLE CABINET GROUP	DESCRIPTION/LIMITATIONS
<b>PowerGlide™ Compact Drawer Outlet</b> (DRWPWR) (DRWPWRB) (DRWPWRL) (DRWPWRR)	Most base cabinets with a top drawer	Installs PowerGlide™ Compact Drawer Outlet into the drawer box. Includes two 120V electrical plug-ins and two 2.1 amp rated USB charging ports with a total rated capacity of 15 amps. Cord has 3 ft. of length hanging freely from back mounting bracket. The cord is 14 gauge wire and features a standard 3-prong plug and is required to be plugged into an approved GFCI outlet for all applications. Outlet is ETL approved-compliant for electrical and other safety standards to U.S. and Canadian safety including UL standards. Outlet face plate measures 5.22" x 2.3" and will extend 3/4" into drawer box. Available on base cabinet widths of 18"-36". For use in cabinet depths of 15", 18", 21", and 24". Only compatible with RD in 3" increments. Also available as a field installed accessory, see DRWPWR1 on page 374.
<b>Push to Open Wastebasket (PTOWB)</b>	Base cabinets with door mounted wastebasket pull-outs	Changes the guide mechanism on wastebasket pull-outs to a mechanical push to open guide with smart close. Available on 24" deep cabinets only. Does not change other drawer guides on the cabinet.
<b>Tilt-out Tray, Stainless Steel Slim (TOTSSS)</b>	Cabinets with false panels	Installs one stainless steel tilt-out tray inside of each false panel. Tray is 1 11/16" deep and protrudes 3/4" into cabinet.

### POWERGLIDE™ COMPACT DRAWER OUTLET (DRWPWR/DRWPWRB/DRWPWRL/DRWPWRR)

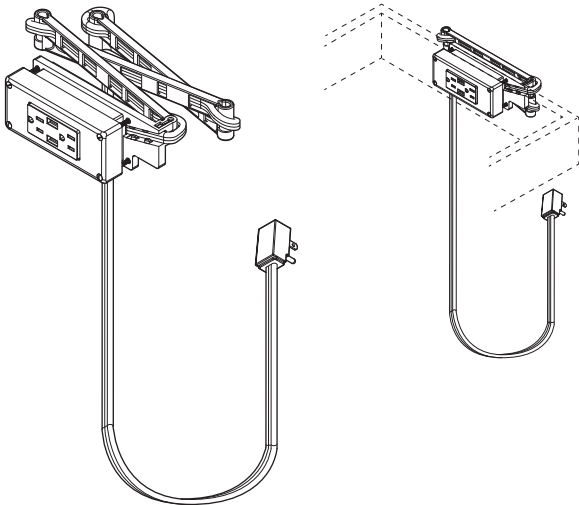

### TILT-OUT TRAY, STAINLESS STEEL SLIM (TOTSSS)

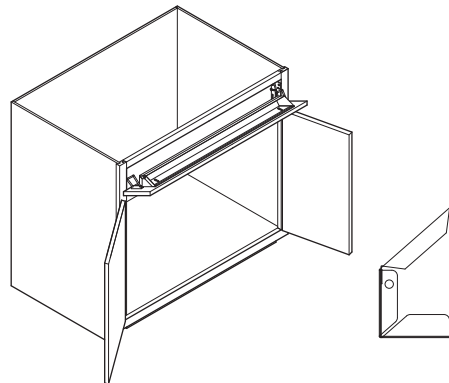

### PUSH TO OPEN WASTEBASKET (PTOWB)

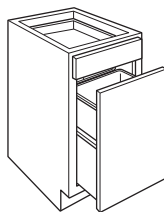

## INSTALLED INTERIOR MODIFICATIONS (cont'd)

See page 37 for modification compatibility. Requests for non-published modifications may be treated as a Special Sales Order which will require feasibility, pricing and leadtime review and approval. Please check with your customer service representative before placing your order.

OPTION NAME	APPLICABLE CABINET GROUP	DESCRIPTION/LIMITATIONS																		
<b>Tray Dividers (TD)</b>	Most wall, full height base, and tall cabinets	<p>Installs removable Tray Dividers. Plywood dividers match the interior of the cabinet. Rails for dividers are Natural Maple regardless of the color of the interior of the cabinet.</p> <p>Number of dividers is predetermined based on cabinet width. See chart below.</p> <p>Available only in the top of Stacked Walls and Tall Cabinets.</p> <p>Available with Reduced Depth modification (12" minimum) and Increased Depth modification (27" maximum). When cabinet is increased to 27", tray dividers will be 24" deep set back 3" into the cabinet.</p> <p>Base Full Height cabinets will have a top. Not available with Peninsula modification.</p> <p>Available on cabinets with frame height openings of 15"-27" with full top and bottom panels.</p> <table border="1" style="margin: 10px auto; border-collapse: collapse;"> <thead> <tr> <th style="text-align: center;">Cabinet Width</th> <th style="text-align: center;"># of Dividers</th> <th style="text-align: center;">Mod Name</th> </tr> </thead> <tbody> <tr> <td style="text-align: center;">9"-12"</td> <td style="text-align: center;">1</td> <td style="text-align: center;">1TD</td> </tr> <tr> <td style="text-align: center;">15"-18"</td> <td style="text-align: center;">2</td> <td style="text-align: center;">2TD</td> </tr> <tr> <td style="text-align: center;">21"-24"</td> <td style="text-align: center;">3</td> <td style="text-align: center;">3TD</td> </tr> <tr> <td style="text-align: center;">27"-31 1/2"</td> <td style="text-align: center;">4</td> <td style="text-align: center;">4TD</td> </tr> <tr> <td style="text-align: center;">33"-37"</td> <td style="text-align: center;">5</td> <td style="text-align: center;">5TD</td> </tr> </tbody> </table>	Cabinet Width	# of Dividers	Mod Name	9"-12"	1	1TD	15"-18"	2	2TD	21"-24"	3	3TD	27"-31 1/2"	4	4TD	33"-37"	5	5TD
Cabinet Width	# of Dividers	Mod Name																		
9"-12"	1	1TD																		
15"-18"	2	2TD																		
21"-24"	3	3TD																		
27"-31 1/2"	4	4TD																		
33"-37"	5	5TD																		

### TRAY DIVIDERS (TD)

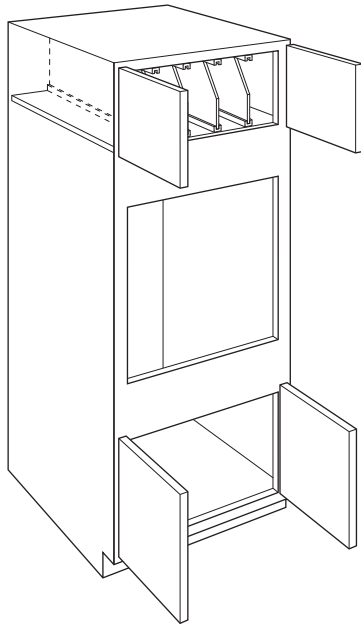

Tall cabinets

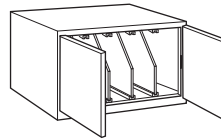

Wall cabinets

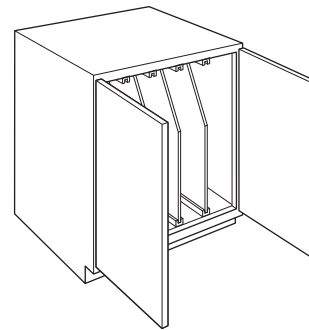

Base cabinets

# TOEKICK MODIFICATIONS

See page 37 for modification compatibility. Requests for non-published modifications may be treated as a Special Sales Order which will require feasibility, pricing and leadtime review and approval. Please check with your customer service representative before placing your order.

OPTION NAME	APPLICABLE CABINET GROUP	DESCRIPTION/LIMITATIONS
<b>Add Toekick (ADDTK)</b>	Most wall cabinets	<p>Creates a 4 1/2" toekick on the front of cabinet. Cabinet top changes to use I-beam construction when ADDTK is selected. ADDTK with reduced depth is available on cabinets 9" deep or larger.</p> <p>Peninsula cabinets are available with ADDTK 15" deep and larger. Depths of 14" and less will not have ADDTK available.</p> <p>Furniture drawers will be available with ADDTK option down to a reduced depth of 12".</p> <p>Available with compatible toekick modifications. See the Modification/Upgrade Compatibility Chart on page 37 for details.</p>
<b>Flush Toekick (FTK) (FTK.FNT.P) (FTK.P)</b>	Most base, tall, and vanity cabinets, and wall cabinets with ADDTK	<p>Extends the face frame to the floor eliminating the toe space. Not available when either RECTKL or RECTKR modifications are used.</p> <p>When FTK is ordered with the Peninsula modification, only the working drawer side will receive a flush toekick.</p> <p>When FTK.FNT.P is ordered with the Peninsula modification, both sides will receive a flush toekick.</p> <p>When FTK.P is ordered with the Peninsula modification, only the peninsula side will receive a flush toekick.</p>

## ADD TOEKICK (ADDTK)

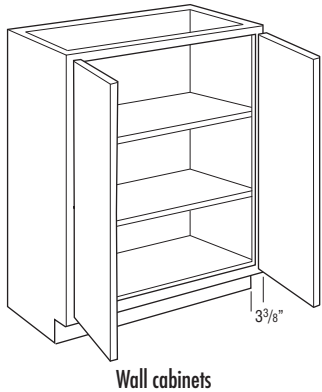

## FLUSH TOEKICK (FTK)

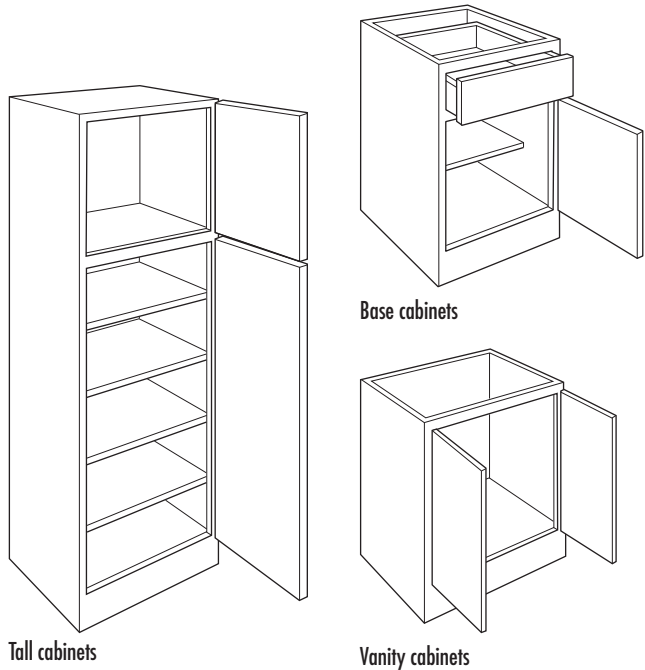

## FLUSH TOEKICK FRONT & PENINSULA (FTK.FNT.P)

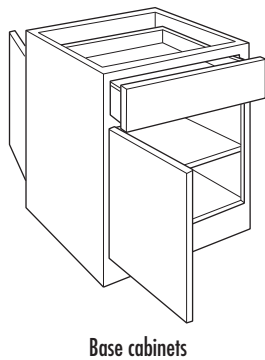

## FLUSH TOEKICK PENINSULA (FTK.P)

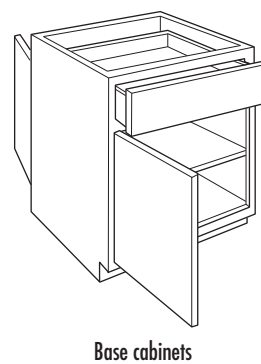

## TOEKICK MODIFICATIONS (cont'd)

See page 37 for modification compatibility. Requests for non-published modifications may be treated as a Special Sales Order which will require feasibility, pricing and leadtime review and approval. Please check with your customer service representative before placing your order.

OPTION NAME	APPLICABLE CABINET GROUP	DESCRIPTION/LIMITATIONS
<b>Flush Toekick Arch (FTKAV) (FTKAV.P) (FTKAV.FNT.P)</b>	Most base, tall, and vanity cabinets, and wall cabinets with ADDTK	Creates an arch flush toe space. Valance replaces standard toekick creating a full open area beneath cabinet floor. When FTKAV.FNT.P is ordered with the Peninsula modification, both sides will receive an arch flush toekick. When FTKAV.P is ordered with the Peninsula modification, only the peninsula side will receive an arch flush toekick.
<b>Flush Toekick Furniture (FTKFV) (FTKFV.P) (FTKFV.FNT.P)</b>	Most base, tall, and vanity cabinets, and wall cabinets with ADDTK	Creates a furniture flush toe space. Valance replaces standard toekick creating a full open area beneath cabinet floor. When FTKFV.FNT.P is ordered with the Peninsula modification, both sides will receive a furniture flush toekick. When FTKFV.P is ordered with the Peninsula modification, only the peninsula side will receive a furniture flush toekick.

### FLUSH TOEKICK ARCH (FTKAV)

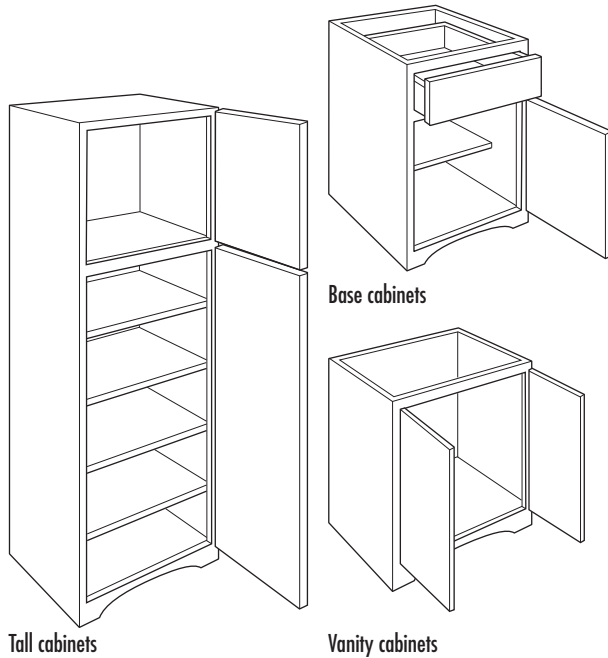

### FLUSH TOEKICK FURNITURE (FTKFV)

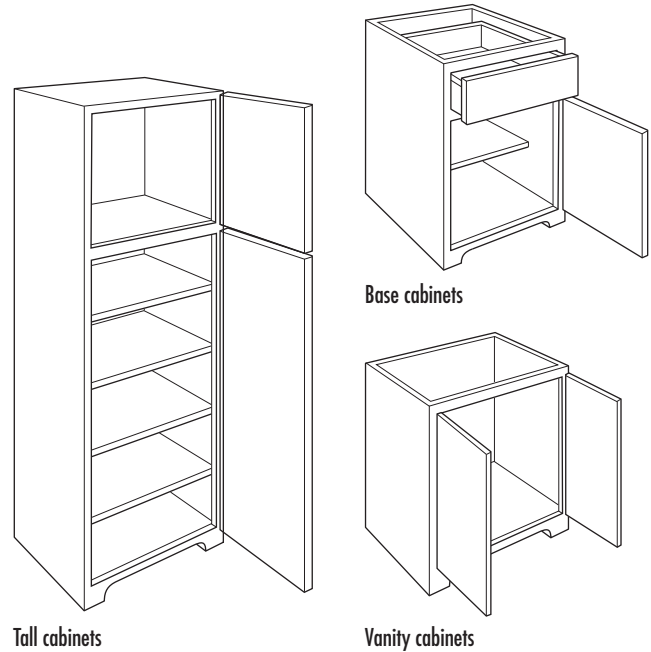

# TOEKICK MODIFICATIONS (cont'd)

See page 37 for modification compatibility. Requests for non-published modifications may be treated as a Special Sales Order which will require feasibility, pricing and leadtime review and approval. Please check with your customer service representative before placing your order.

OPTION NAME	APPLICABLE CABINET GROUP	DESCRIPTION/LIMITATIONS
<b>Loose Toekick (TKP)</b>	Most tall cabinets	Available on 84", 87", and 90" tall cabinets. Removes and ships the toekick separately. Not compatible with other toekick modifications. Pedestal is designed to create a Recessed Left or Right Toekick (RECTKL or RECTKR) application during field installation, or can be centered. Pedestal must be covered with toeboard material.
<b>Recessed Island Toekick (RECTKALL)</b>	Most base and vanity cabinets, and wall cabinets with ADDTK	Creates a 3 3/8" recessed toekick on the right, left, and back of cabinet. The entire toekick area will have non-matching material and requires any exposed toekick area to be covered. RECTKALL only available on cabinets at least 15" deep.
<b>Recessed Toekick on Back or Side (RECTKBK) (RECTKL) (RECTKR)</b>	Most base and vanity cabinets, and wall cabinets with ADDTK	Creates a 3 3/8" recessed toekick on the back (RECTKBK), left (RECTKL), or right (RECTKR). When either the RECTKR or RECTKL are used, FTK is NOT available. The entire toekick will have non-matching material and requires any exposed toekick area to be covered. On RECTKL and RECTKR, the back will have a 1/2" recessed offset and non-specified side will have a 1/2" recessed offset to allow for application of toeboard material.  93" and 96" tall cabinets have RECTKL or RECTKR standard on loose pedestal. For recess toekick applications of both left and right, order RECTKL.R. On 9" wide cabinets, only one side can be recessed. RECTKBK only available on cabinets at least 15" deep.

## LOOSE TOEKICK (TKP)

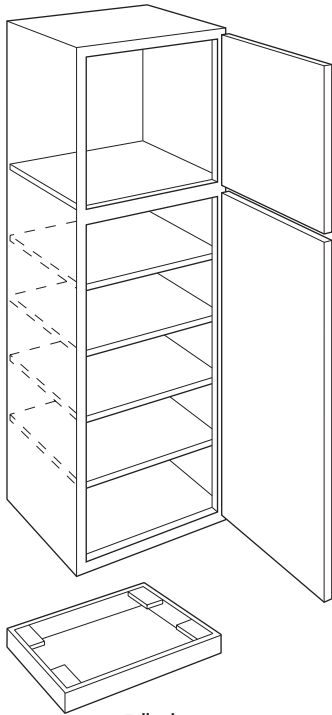

Tall cabinets

Pedestal is reduced in width for RECTKL or RECTKR during field installation.

## RECESSED ISLAND TOEKICK (RECTKALL)

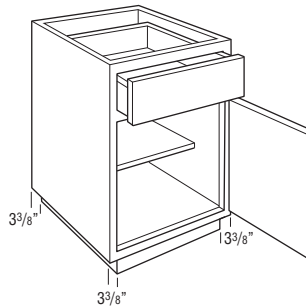

Base cabinets

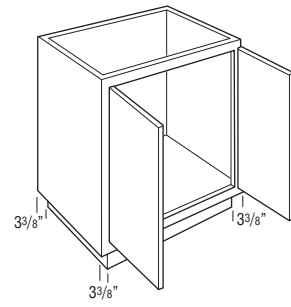

Vanity cabinets

## RECESSED TOEKICK - BACK (RECTKBK)

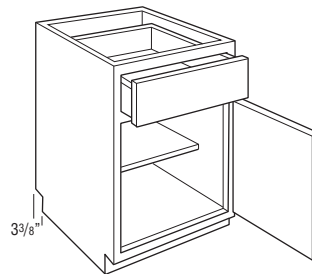

Base cabinets

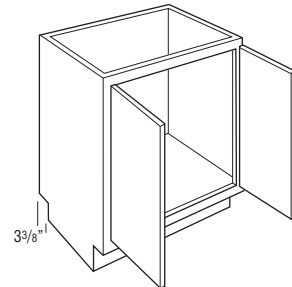

Vanity cabinets

## RECESSED TOEKICK - LEFT (RECTKL)

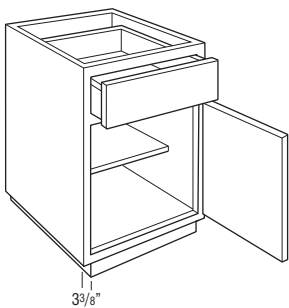

Base cabinets

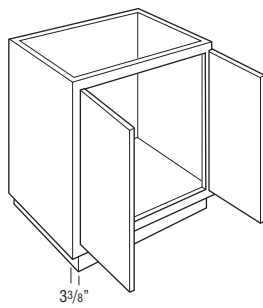

Vanity cabinets

## RECESSED TOEKICK - RIGHT (RECTKR)

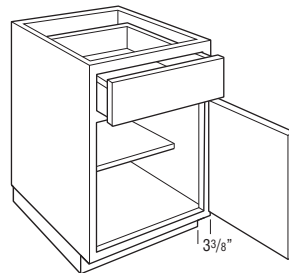

Base cabinets

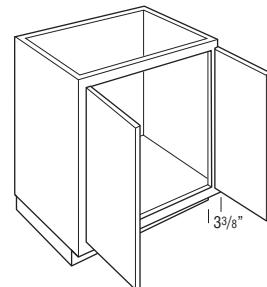

Vanity cabinets

## TOEKICK MODIFICATIONS (cont'd)

See page 37 for modification compatibility. Requests for non-published modifications may be treated as a Special Sales Order which will require feasibility, pricing and leadtime review and approval. Please check with your customer service representative before placing your order.

OPTION NAME	APPLICABLE CABINET GROUP	DESCRIPTION/LIMITATIONS
<b>Toekick Drawer (DRWTK)</b>	Most cabinets with a standard toekick, and wall cabinets with ADDTK	Replaces standard toekick with a toekick drawer. Available on most 21"-24" deep cabinets in 18", 21", 24", 27", 30", 33", and 36" widths that have standard toekick construction. Front of toekick drawer is unfinished, allow enough toeboard to cover. 1" clearance below toekick drawer. Exterior dimensions of drawer are 3 3/8" tall and 15" or 18" deep. Toekick drawer uses a push to open full extension side-mount guide, does not have soft-close feature.
<b>Void Toekick (VTK)</b>	Most base, tall, and vanity cabinets	Removes the toekick. Only available when the cabinet has a standard toekick (not available when flush toekick is standard or when cabinet has a separate pedestal base). When VTK is specified on cabinets to be used with a countertop, cabinets must also be supported from the floor, not just attached to the wall. Failure to properly install cabinets in this situation will void the warranty.

### TOEKICK DRAWER (DRWTK)

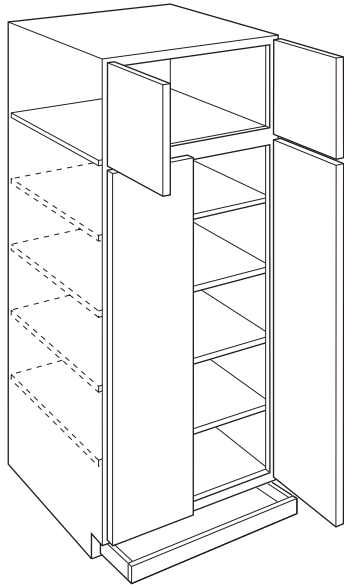

Tall cabinets

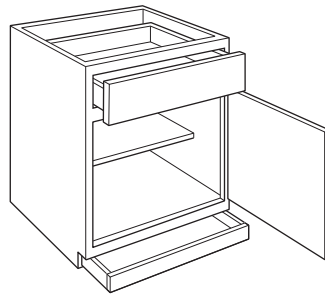

Base cabinets

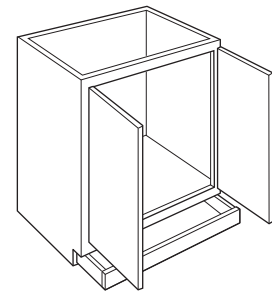

Vanity cabinets

### VOID TOEKICK (VTK)

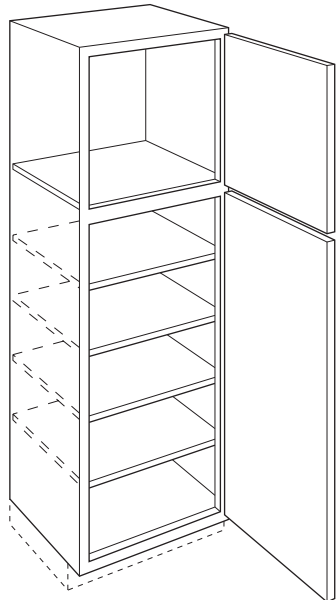

Tall cabinets

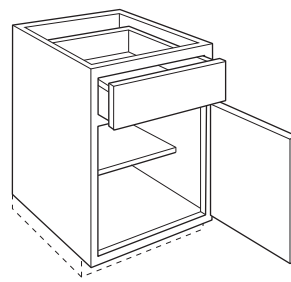

Base cabinets

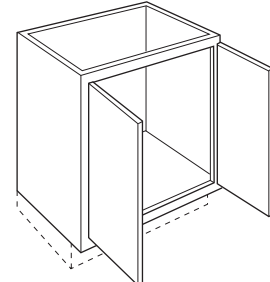

Vanity cabinets

# CONFIGURATION MODIFICATIONS

See page 37 for modification compatibility. Requests for non-published modifications may be treated as a Special Sales Order which will require feasibility, pricing and leadtime review and approval. Please check with your customer service representative before placing your order.

OPTION NAME	APPLICABLE CABINET GROUP	DESCRIPTION/LIMITATIONS
<b>Cabinet Front Only (CFNTO)</b>	Most cabinets with a face frame	Creates a door and/or drawer front assembled with a frame. Doors are attached with the specified hinges and drawer fronts are cleated.
<b>Cabinet Frame Only (CFRMO)</b>	Most cabinets with a face frame	Creates a cabinet frame only. No box, doors, or drawer fronts are included.
<b>Peninsula (P)</b>	Most wall and base cabinets	Creates a peninsula cabinet that is 1/4" deeper than the standard cabinet depth. If ID or RD is specified, cabinet will be 1/4" deeper than specified cabinet depth. Any adjustable shelves are upgraded to full depth.  Any cabinet with a toekick must be at least 15" deep (either standard with a toekick or when ADDTK is specified).  Single door cabinets are hinged on the same cabinet end, for example a W1230L will feature a Left hinge on the front side and a Right hinge on the peninsula side.  Not available on tall cabinets (oven, utility, and pantry) or multi-drawer base cabinets.  Cabinets with drawers can only be reduced in 3" increments.  Peninsula cabinets are not designed to be used as stand alone island cabinets.  The maximum depth for wall cabinets with the Peninsula modification is 18".

## CABINET FRONT ONLY (CFNTO)

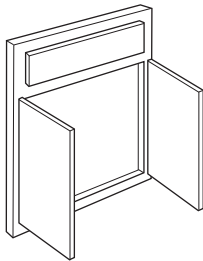

Cabinet front only – Wall, Base, and Tall

## CABINET FRAME ONLY (CFRMO)

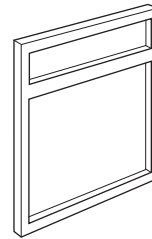

Cabinet frame only – Wall, Base, and Tall

## PENINSULA (P)

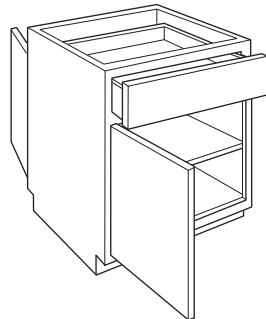

Base cabinets

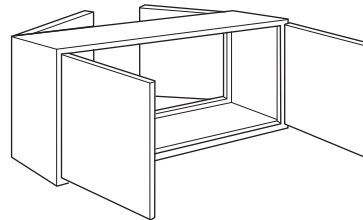

Wall cabinets



# ALUMINUM FRAME DOOR OPTIONS

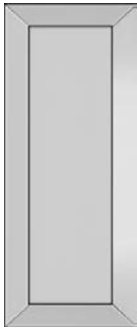

**ALF**  
Aluminum Frame Door  
in Aluminum finish  
with Frost glass



**ALFBS**  
Aluminum Frame Door  
with a Brushed Stainless  
Steel look with Frost glass



**ALFBL**  
Aluminum Frame Door  
with a Black powder coat  
finish with Frost glass

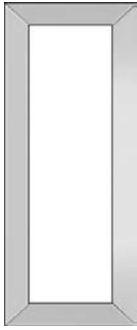

**ALFC**  
Aluminum Frame Door  
in Aluminum finish  
with Clear glass

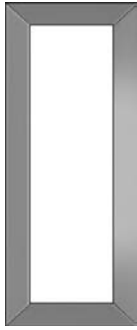

**ALFBSC**  
Aluminum Frame Door  
with a Brushed Stainless Steel  
look with Clear glass



**ALFBLC**  
Aluminum Frame Door  
with a Black powder coat  
finish with Clear glass

- All aluminum doors will be full overlay with miter construction.
- Cabinet face frame and end panels will be matched to the finish specified.
- Aluminum and Brushed Stainless doors have an anodized finish.
- Black doors have a powder coated finish.
- Glass and matching panel are installed in door, removal will void warranty.
- Door rails are 2 1/4" wide.
- All Aluminum Frame door options are represented by ALF in Door Options availability grids.
- Cabinet will have standard interior or can be ordered with MIP option. When a decorative door option is chosen in 20/20, Matching Interior Plywood (MIP) is a preselected option. If MIP is not desired, it can be deselected by choosing NOTMIP.
- Aluminum Frame Door options are compatible with Face Frame and Door on End modifications (FFDL and FFDR). The ALF\_ door upcharge will also apply to the side door.

## ALF AVAILABILITY

Cabinet Width	Cabinet Height					
	12"	15"	18"	21"	30"	36"
W12	N/A	N/A	N/A	N/A	B	C
W15	A	A	N/A	N/A	B	C
W18	A	A	N/A	N/A	B	C
W21	N/A	N/A	N/A	N/A	B	C
WTH30 & WTH30..24	B	B	B	B	N/A	N/A
WVL30 & WVL30..24	N/A	N/A	B	B	N/A	N/A
WTH36 & WTH36..24	C	C	C	C	N/A	N/A
WVL36 & WVL36..24	N/A	N/A	C	C	N/A	N/A

## CUT-FOR-GLASS DOORS (CG)

Glass not included

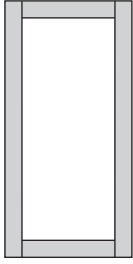

Cut-for-glass

- Not available in Door 19, Door 25, Door 33, Door 36, Door 37, and Door 44.
- If desired for use with Door 19 or Door 44, using a shaker style such as Door 15, Door 18, or Door 38 is recommended.
- If ordered in an MDF door style, door will be Maple. On Stacked Wall (STW\_ \_) and Utility cabinets (U\_ \_), all cabinet doors will be Maple when ordered with a Cut-for-glass Door.
- Not available on bifold doors.
- Specify Door Style and Finish when ordering Cut-for-glass Doors.
- Custom door sizes available. See pages 326-331.
- Glass clips included with door, but glass is not included.
- For cabinet availability, please see modification grids.
- CG.TOP and CG.BTM are specified on cabinets with upper and lower doors to designate which doors should be Cut-for-glass. See Door Options grid for SKU availability.
- When a decorative door option is chosen in 20/20, Matching Interior Plywood (MIP) is a preselected option. If MIP is not desired, it can be deselected by choosing NOTMIP.
- All textured glass panels will be drop shipped separately from the cabinet order.
- Glass installation clips will ship with the doors and/or cabinets.
- The use of glass for base cabinet applications or for placement near interior or exterior doors is not recommended.

# MULLION DOORS (MD)

Glass not included

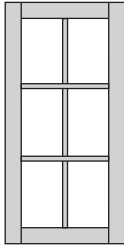

Mullion

- Available in all door styles except Door 19, Door 25, Door 28, Door 33, Door 35, Door 36, Door 37, Door 41, and Door 44.
- Custom Door Sizes not available.
- For Mullion Door availability, please see modification grids in wall section.
- If ordered in an MDF door style, door will be Maple.
- Includes mullion door only. Glass may be ordered separately. See page 68 for details.
- Not compatible with Beveled glass.
- MD.TOP and MD.BTM are specified on cabinets with upper and lower doors to designate which doors should be Mullion Doors. See Door Options grid for SKU availability.
- Shelves will not align with mullions.
- When a decorative door option is chosen in 20/20, Matching Interior Plywood (MIP) is a preselected option. If MIP is not desired, it can be deselected by choosing NOTMIP.
- All textured glass panels will be drop shipped separately from the cabinet order.
- Glass installation clips will ship with the doors and/or cabinets.
- The use of glass for base cabinet applications or for placement near interior or exterior doors is not recommended.

## MULLION LITES GRID

Cabinet Width*	Cabinet Height							
	15"	18"	24"	30"	33"	36"	39"	42"
W15	G	G	G	D	D	D	A	A
W18	G	G	G	D	D	D	A	A
W21	G	G	G	D	D	D	A	A
W24	G	G	G	D	D	D	A	A
W24 (butt)	G	G	G	D	D	D	A	A
W27 (butt)	G	G	G	D	D	D	A	A
W30 (butt)	G	G	G	D	D	D	A	A
W33 (butt)	G	G	G	D	D	D	A	A
W36 (butt)	G	G	G	D	D	D	A	A
W42 (CS)	G	G	G	D	D	D	A	A
W45 (CS)		G	G	D	D	D	A	A
W48 (CS)		G	G	D	D	D	A	A
W48 (butt)	G	G	G	D	D	D	A	A
WC30				D	D	D	A	A
WC33				D	D	D	A	A
WC36				D	D	D	A	A
WC39				D	D	D	A	A
WC42				D	D	D	A	A
WC45				D	D	D	A	A
WC48				D	D	D	A	A
DW	G	G	G	D	D	D	A	A

\*Stacked wall cabinets (STW\_\_ and STWC\_\_) also available with MD option in selected widths.

## Mullion Door Configurations

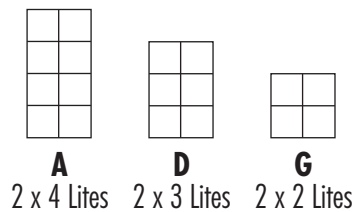

# SHAKER MULLION DOORS (SHMD)

Glass not included

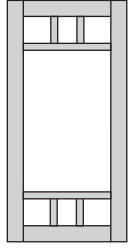

62

DOOR MODIFICATION/SPECIALTY DOORS

- Available in Door 15, Door 18, Door 38, Door 42, and Door 46.
- Custom Door Sizes not available.
- Shelves will not align with mullions.
- For Mullion Door availability, please see modification grids in wall section.
- If ordered in an MDF door style, door will be Maple.
- Includes mullion door only. Glass may be ordered separately. See page 68 for details.
- Not compatible with Beveled glass.
- When a decorative door option is chosen in 20/20, Matching Interior Plywood (MIP) is a preselected option. If MIP is not desired, it can be deselected by choosing NOTMIP.
- All textured glass panels will be drop shipped separately from the cabinet order.
- Glass installation clips will ship with the doors and/or cabinets.
- The use of glass for base cabinet applications or for placement near interior or exterior doors is not recommended.

### MULLION SHAKER LITES GRID

Cabinet Width*	Cabinet Height						
	18"	24"	30"	33"	36"	39"	42"
W15†	H	H	H	H	H	H	H
W18	H	H	H	H	H	H	H
W21	H	H	H	H	H	H	H
W24	H	H	H	H	H	H	H
W24 (butt)	J	J	J	J	J	J	J
W27 (butt)	J	J	J	J	J	J	J
W30 (butt)†	H	H	H	H	H	H	H
W33 (butt)	H	H	H	H	H	H	H
W36 (butt)	H	H	H	H	H	H	H
W42 (CS)	H	H	H	H	H	H	H
W45 (CS)	H	H	H	H	H	H	H
W48 (CS)	H	H	H	H	H	H	H
W48 (butt)	J	J	J	J	J	J	J
WC30	J	J	J	J	J	J	J
WC33			H	H	H	H	H
WC36			H	H	H	H	H
WC39			J	J	J	J	J
WC42			J	J	J	J	J
WC45			H	H	H	H	H
WC48			H	H	H	H	H
DW†	H	H	H	H	H	H	H

### Shaker Mullion Door Configurations

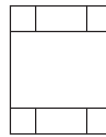

**H**  
3 x 3 Lites

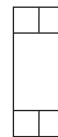

**J**  
2 x 3 Lites

\*Stacked wall cabinets (STW\_\_ and STWC\_\_) also available with SHMD option in selected widths.

†Door 18 and Door 38 will have "J Configuration" for 15" and 30" wide cabinets and all DW cabinets.

# PRAIRIE MULLION DOORS (PRMD)

Glass not included

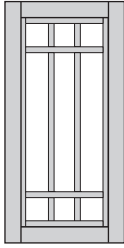

- Available in Door 15, Door 18, Door 38, Door 42, and Door 46.
- Custom Door Sizes not available.
- Shelves will not align with mullions.
- For Mullion Door availability, please see modification grids in wall section.
- If ordered in an MDF door style, door will be Maple.
- Includes mullion door only. Glass may be ordered separately. See page 68 for details.
- Not compatible with Beveled glass.
- When a decorative door option is chosen in 20/20, Matching Interior Plywood (MIP) is a preselected option. If MIP is not desired, it can be deselected by choosing NOTMIP.
- All textured glass panels will be drop shipped separately from the cabinet order.
- Glass installation clips will ship with the doors and/or cabinets.
- The use of glass for base cabinet applications or for placement near interior or exterior doors is not recommended.

## MULLION PRAIRIE LITES GRID

Cabinet Width*	Cabinet Height						
	18"	24"	30"	33"	36"	39"	42"
W15†	K	K	K	K	K	K	K
W18	K	K	K	K	K	K	K
W21	K	K	K	K	K	K	K
W24	K	K	K	K	K	K	K
W24 (butt)	L	L	L	L	L	L	L
W27 (butt)	L	L	L	L	L	L	L
W30 (butt)†	K	K	K	K	K	K	K
W33 (butt)	K	K	K	K	K	K	K
W36 (butt)	K	K	K	K	K	K	K
W42 (CS)	K	K	K	K	K	K	K
W45 (CS)	K	K	K	K	K	K	K
W48 (CS)	K	K	K	K	K	K	K
W48 (butt)	L	L	L	L	L	L	L
WC30	L	L	L	L	L	L	L
WC33			K	K	K	K	K
WC36			K	K	K	K	K
WC39			L	L	L	L	L
WC42			L	L	L	L	L
WC45			K	K	K	K	K
WC48			K	K	K	K	K
DW†	K	K	K	K	K	K	K

\*Stacked wall cabinets (STW\_\_ and STWC\_\_) also available with PRMD option in selected widths.

†Door 18 and Door 38 will have "L Configuration" for 15" and 30" wide cabinets and all DW cabinets.

## Prairie Mullion Door Configurations

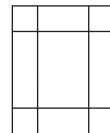

**K**  
3 x 3 Lites



**L**  
2 x 3 Lites

# ART GLASS PANELS



Anson

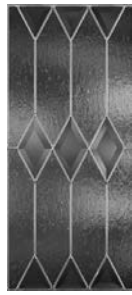

Avondale



Charlotte



Lanai

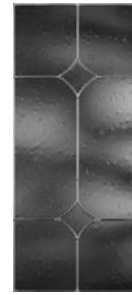

Lonsdale

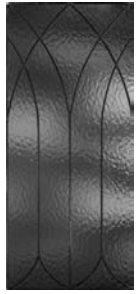

Lyndhurst



Pavillion

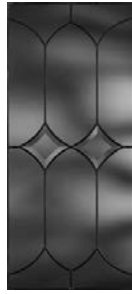

Portico



Waterbury

- Cut-for-glass and Mullion doors must be ordered separately. See pages 60-63 for door style availability.
- For glass shelf kits, see page 362.
- Door frame may reduce amount of glass shown.
- No changes or cancellations will be accepted after 24 hours from acknowledgment of order.
- Art glass will be packaged separately from applicable cabinet(s) and shipped with cabinet order for field installation.
- The use of glass for base cabinet applications or for placement near interior or exterior doors is not recommended.

STYLE	PANEL THICKNESS	CAMING MATERIAL
Anson	1/4"	Zinc Black Patina
Avondale	1/4"	Zinc
Charlotte	1/4"	Zinc
Lanai	1/4"	Zinc
Lonsdale	1/4"	Zinc
Lyndhurst	1/4"	Zinc Black Patina
Pavillion	1/4"	Zinc
Portico	1/4"	Zinc Black Patina
Waterbury	1/4"	Zinc Black Patina

# ART GLASS PANELS

## Anson

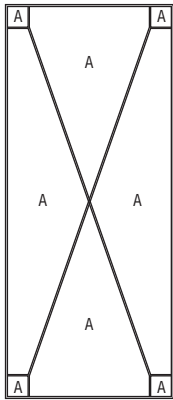

Minimum Size  
6" x 6"

$1\frac{3}{8}$ "  
 $1\frac{3}{8}$ "

Glass Type:  
A) Clear Seedy 100SDY

Metal Type:  
 $\frac{3}{16}$ " H-Ch Zinc Proglaze2 (all)  
Black Patina Finish

## Charlotte

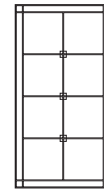
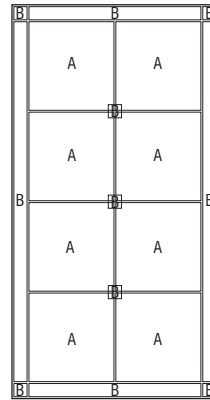

Heights > 23"  
3 Horizontal Bars

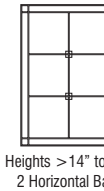

Heights > 14" to 23"  
2 Horizontal Bars

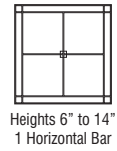

Heights 6" to 14"  
1 Horizontal Bar

**B**  
Overlay  
 $1\frac{5}{16}$ " x  $1\frac{5}{16}$ "

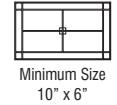

Minimum Size  
10" x 6"

Glass Types:  
A)  $\frac{1}{8}$ " Clear  
B) Frost Etch 100

Metal Types:  
 $\frac{3}{16}$ " H-Ch Zinc Proglaze2 (all)  
 $\frac{1}{8}$ " U-Ch Zinc (overlays)

## Avondale

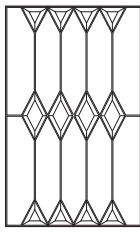
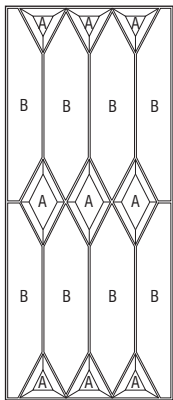

Widths > 13"  
4 Vertical Columns

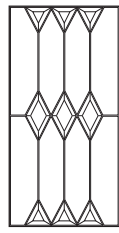

Widths > 10" to 13"  
3 Vertical Columns



Widths > 7" to 10"  
2 Vertical Columns



$1\frac{3}{4}$ "  
3"  
 $1\frac{3}{4}$ "  
6"

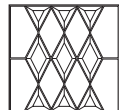

Heights > 13"  
Full Design

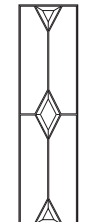

Widths 6" to 7"  
1 Vertical Column

Glass Types:  
A)  $\frac{3}{16}$ " Clear with  $\frac{1}{2}$ " Bevel  
B) Clear Vecchio 100V

Metal Type:  
 $\frac{3}{16}$ " H-Ch Zinc Proglaze2 (all)



Heights < 13"  
Diamond(s) Only



Minimum Size  
6" x  $6\frac{1}{4}$ "

## Lanai

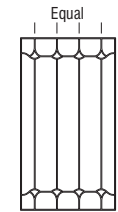

Widths > 16"  
4 Vertical Columns



Widths > 11" to 16"  
3 Vertical Columns

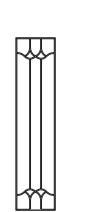

Widths 6" to 11"  
2 Vertical Columns

Equal  
3.2107"

Glass Type:  
A)  $\frac{1}{8}$ " Clear

Metal Type:  
 $\frac{3}{16}$ " H-Ch Zinc Proglaze2 (all)

# ART GLASS PANELS

## Lonsdale

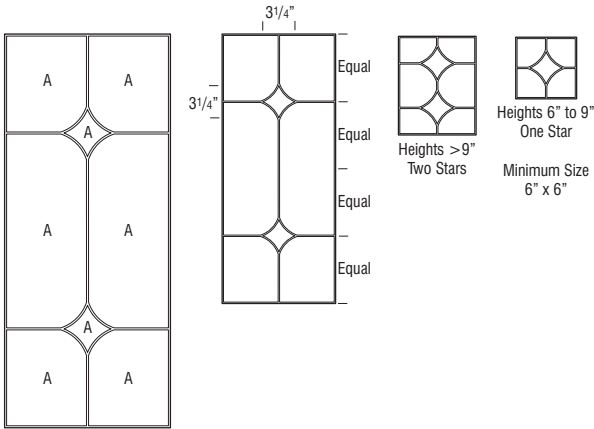

Glass Type:  
A) Seedy Clear 100Sdy  
Metal Type:  
3/16" H-Ch Zinc Proglaze2 (all)

## Pavillion

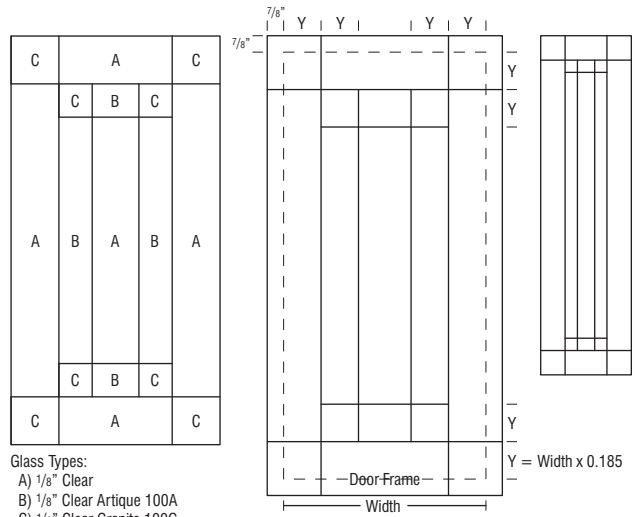

Glass Types:  
A) 1/8" Clear  
B) 1/8" Clear Artique 100A  
C) 1/8" Clear Granite 100G  
Metal Type:  
3/16" H-Ch Round Zinc Proglaze2 (all)

## Lyndhurst

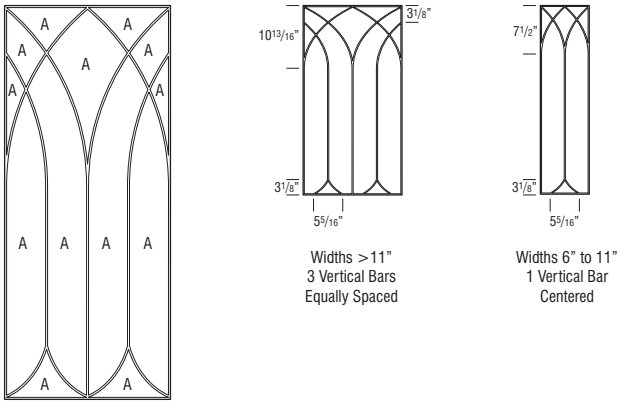

Glass Type:  
A) Clear Rough Rolled 100RR  
Metal Type:  
3/16" H-Ch Zinc Proglaze2 (all)  
Black Patina Finish  
Minimum Size 6" x 12"

## Portico

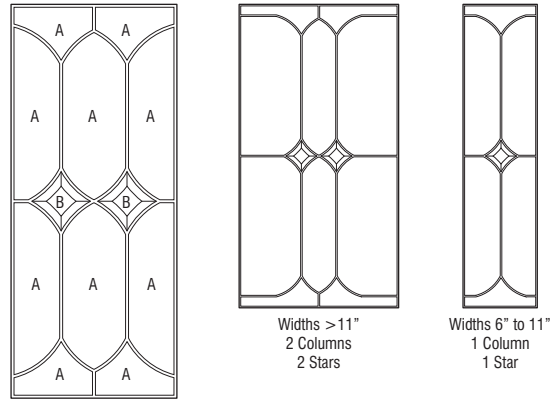

Glass Types:  
A) 1/8" Clear  
B) 3/16" Clear with 1/2" Bevel  
Metal Type:  
3/16" H-Ch Zinc Proglaze2 (all)  
Black Patina Finish  
Minimum Size 6" x 12"



# ART GLASS PANELS

## Waterbury

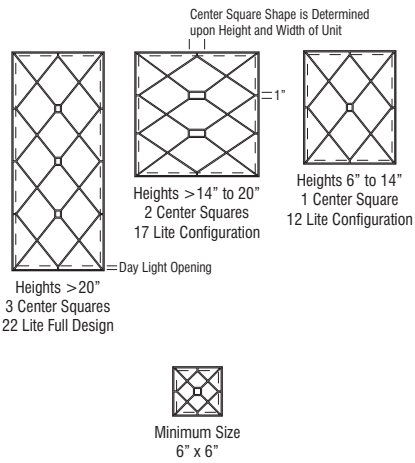
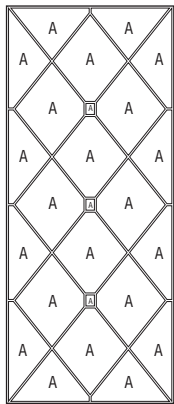

Glass Type:  
A) Clear Waterglass 100W

Metal Type:  
3/16" H-Ch Zinc Proglaze2 (all)  
Black Patina Finish

# TEXTURED GLASS PANELS



Antique



Bevel



Clear



Frost

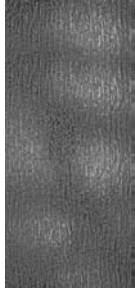

Rain

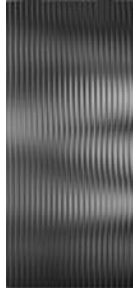

Reeded



Seeded



Silhouette

- Cut-for-glass door must be ordered separately. See page 60 for door style availability.
- For glass shelf kits, see page 362.
- When textured glass is ordered for use in wall top hinge (WTH) or wall vertical-lift (WVL) cabinets, glass design will be turned horizontally and may not match desired pattern.
- Door frame may reduce amount of glass shown.
- No changes or cancellations will be accepted after 24 hours from acknowledgment of order.
- All textured glass panels will be drop shipped separately from the cabinet order.
- Glass installation clips will ship with the doors and/or cabinets.
- The use of glass for base cabinet applications or for placement near interior or exterior doors is not recommended.

STYLE	PANEL THICKNESS
Antique	1/8"
Bevel	1/4"
Clear	1/8"
Frost	5/32"
Rain	5/32"
Reeded	5/32"
Seeded	9/32"
Silhouette	1/8"

# TEXTURED GLASS PANELS

## Antique



- Glass type: Antique
- Panel thickness: 1/8"

## Frost

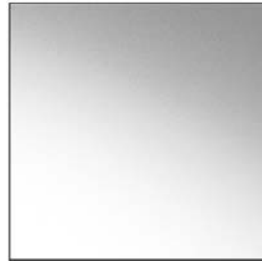

- Glass type: Frost
- Panel thickness: 5/32"

## Bevel

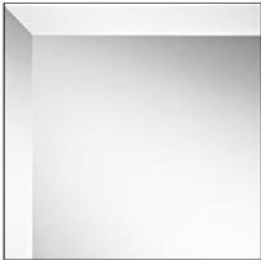

- Glass type: Clear
- Panel thickness: 1/4"
- Not compatible with Mullion Doors.

## Rain

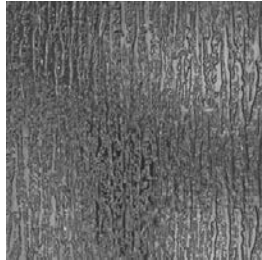

- Glass type: Rain
- Panel thickness: 5/32"

## Clear

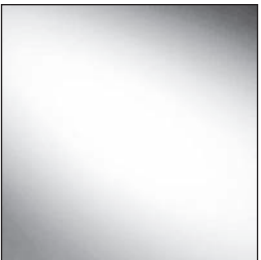

- Glass type: Clear
- Panel thickness: 1/8"

## Reeded

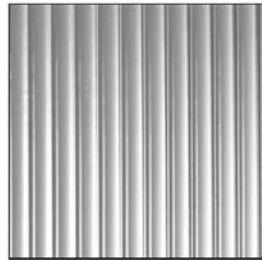

- Glass type: Reeded
- Panel thickness: 5/32"

# TEXTURED GLASS PANELS

## Seeded

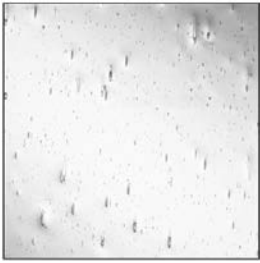

- Glass type: Seeded
- Panel thickness: 9/32"

## Silhouette

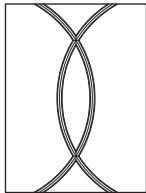
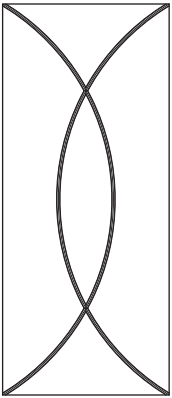

When the Width is Greater Than 2/3 the Height, the Design is Centered and Does Not Finish in the Corners

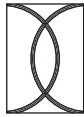

Minimum Size  
Height 8 1/2"  
Width 6"

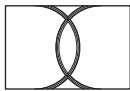

Width Greater Than Height\*

- Glass type: Frost Etch
- Panel thickness: 1/8"

\*Not recommended for use with Door 16, Door 23, Door 29, Door 34, Door 43, and Door 45 door styles.

# CABINET DIMENSIONS

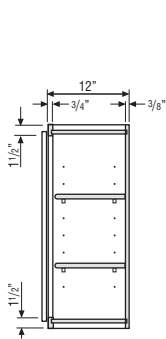

**WALL CABINET**

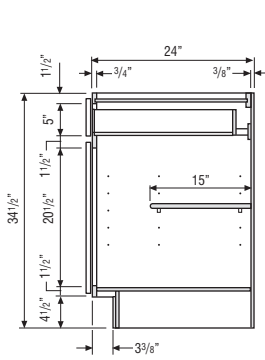

**BASE CABINET**

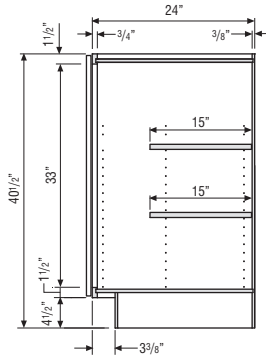

**40 1/2" HIGH  
FULL HEIGHT  
BASE CABINET**

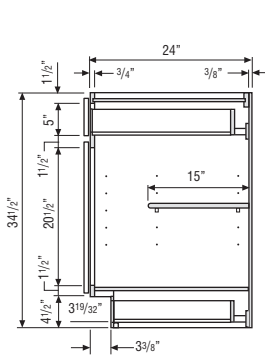

**BASE CABINET  
with TOEKICK  
DRAWER**

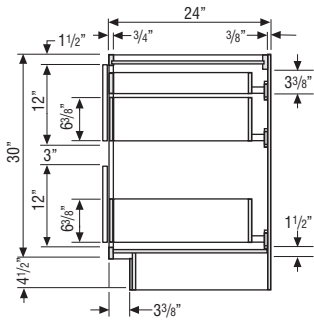

**TWO-DRAWER  
BASE CABINET  
with ROLL TRAY**

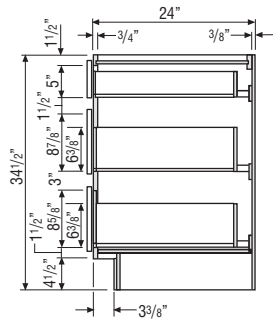

**THREE-DRAWER  
BASE CABINET**

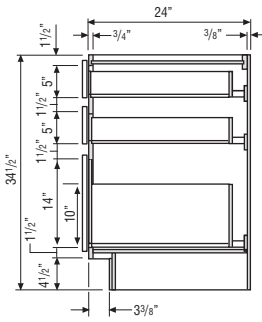

**THREE-DRAWER  
BASE CABINET  
with DEEP DRAWER**

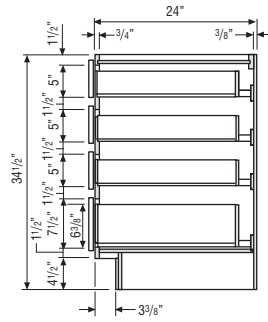

**FOUR-DRAWER  
BASE CABINET**

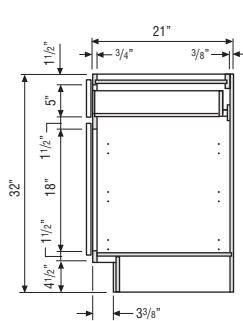

**32" HIGH  
VANITY CABINET**

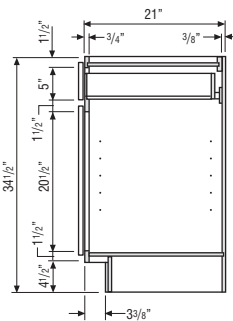

**34 1/2" HIGH  
VANITY CABINET**

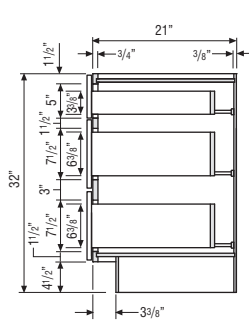

**32" HIGH  
VANITY DRAWER  
BASE CABINET**

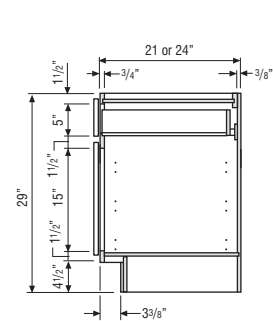

**DESK BASE CABINET**

# CABINET DIMENSIONS

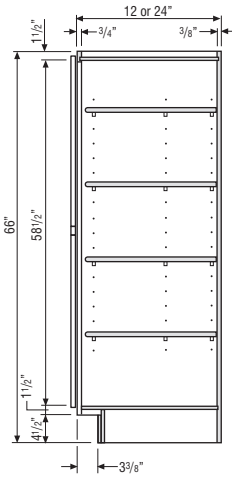

**UTILITY CABINET**

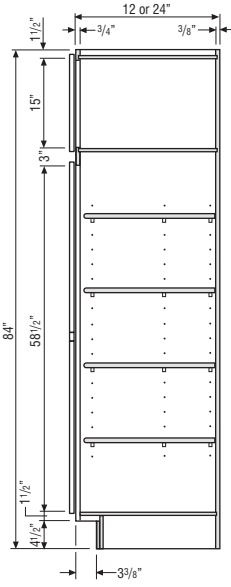

**UTILITY CABINET**

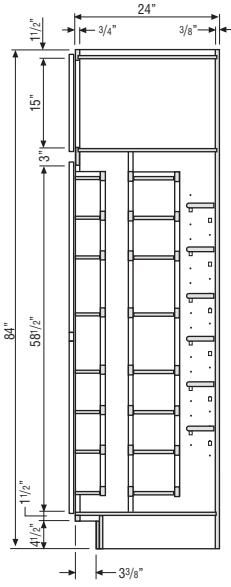

**PANTRY CABINET**

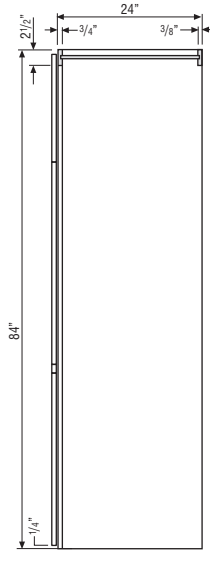

**PANTRY WALK-THROUGH**

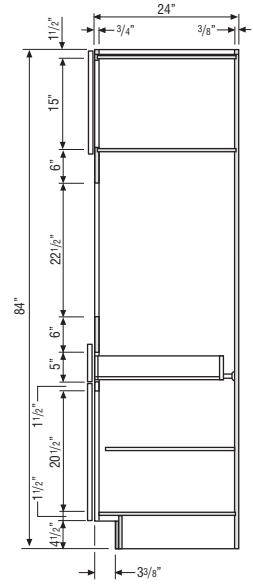

**SINGLE OVEN CABINET**

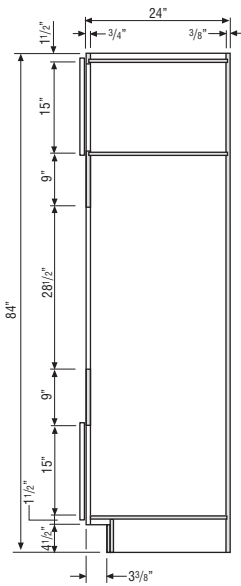

**OVEN MICROWAVE COMBO CABINET**

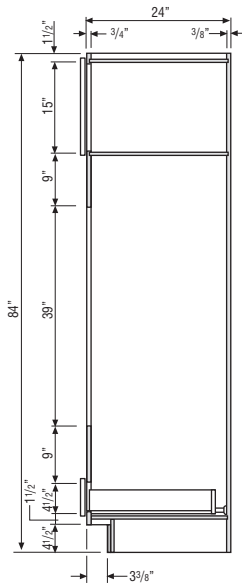

**DOUBLE OVEN CABINET**

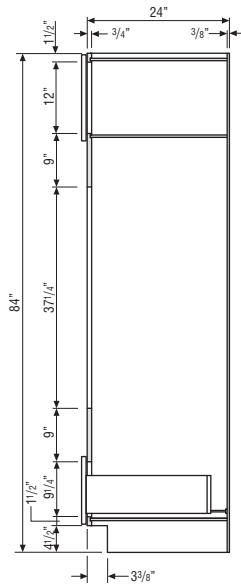

**DOUBLE OVEN CABINET DEEP DRAWER**

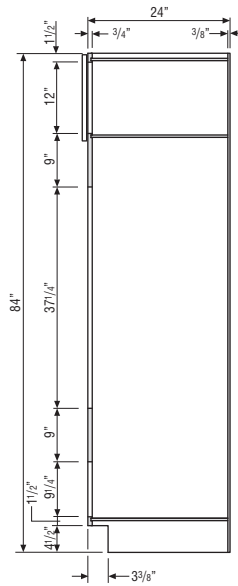

**DOUBLE OVEN CABINET WARMING DRAWER**

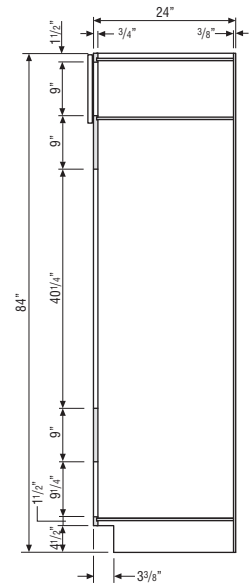

**DOUBLE OVEN CABINET WARMING DRAWER with EXTENDED OPENING**

# CABINET DIMENSIONS

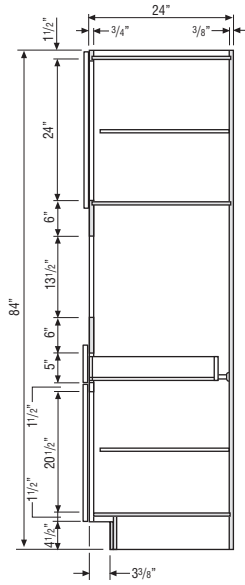

**TALL BUILT-IN  
MICROWAVE CABINET**

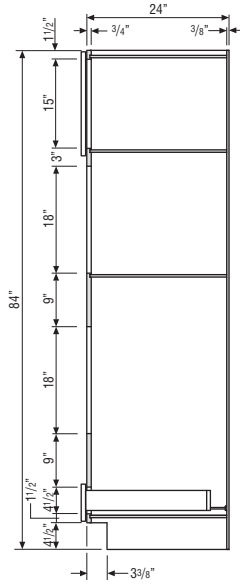

**OVEN MICROWAVE  
CABINET**

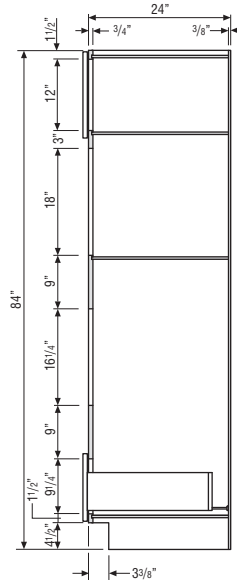

**OVEN MICROWAVE  
CABINET  
DEEP DRAWER**

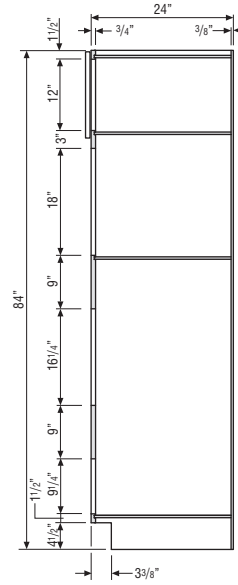

**OVEN MICROWAVE  
CABINET  
WARMING DRAWER**

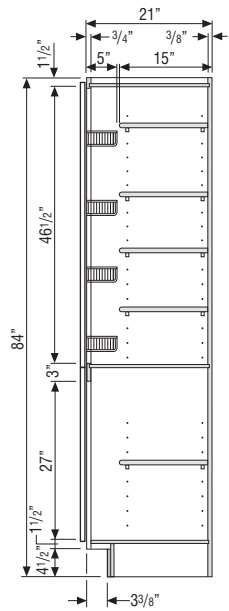

**LC/LCRH/LT  
CABINET**

(Aligns with 34 1/2" High  
Vanity Base Cabinets)

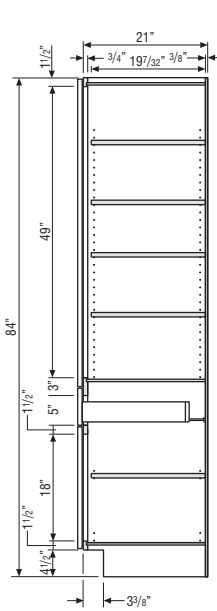

**LINEN TALL  
with DRAWER**

(Aligns with 32" High  
Vanity Base Cabinets)

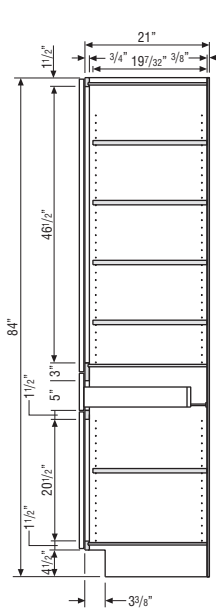

**LINEN TALL  
with DRAWER**

(Aligns with 34 1/2" High  
Vanity Base Cabinets)

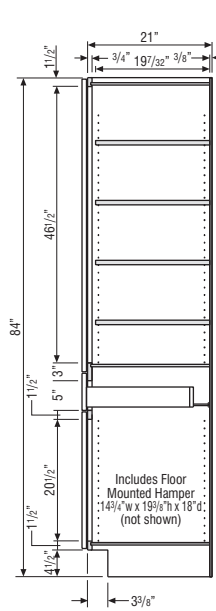

**LINEN TALL with DRAWER  
and REMOVABLE HAMPER**

(Aligns with 34 1/2" High  
Vanity Base Cabinets)

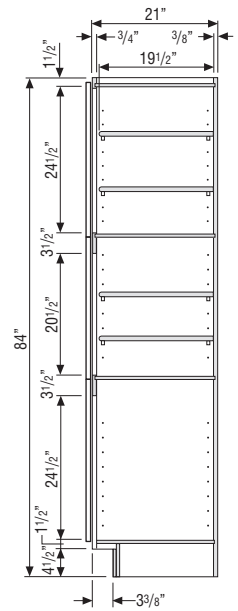

**VANITY UTILITY  
CABINET**

(Aligns with 32" High  
Vanity Base Cabinets)

# CABINET DIMENSIONS

## ROLL TRAY POSITIONS

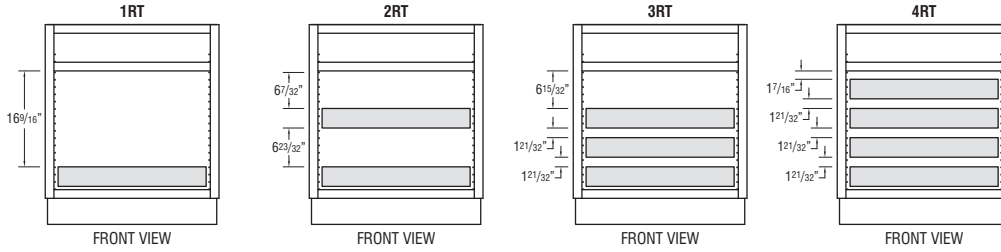

## BASE CABINETS AND 34 1/2" HIGH VANITY CABINETS

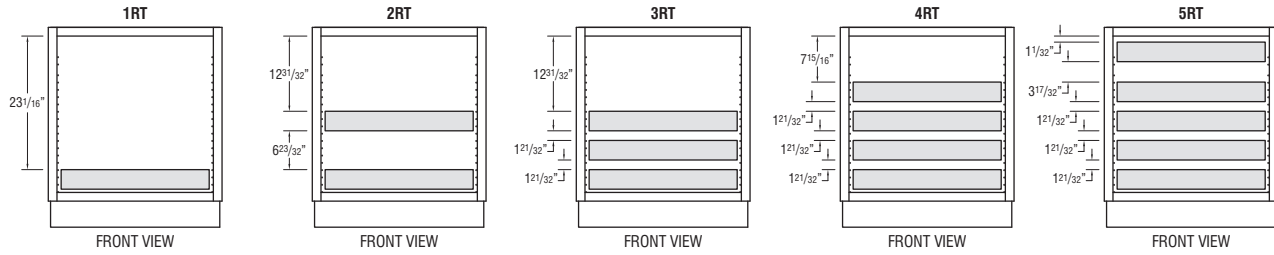

## FULL HEIGHT BASE CABINETS

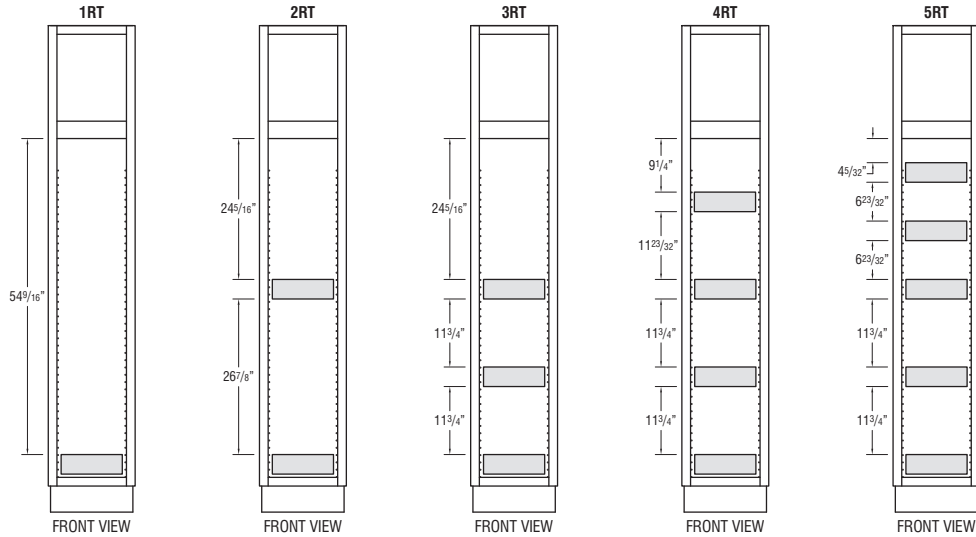

## UTILITY CABINETS

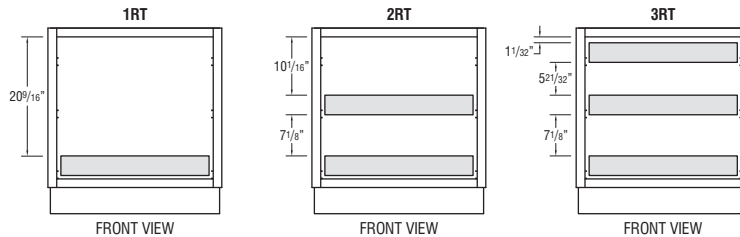

## 32" HIGH VANITY CABINETS

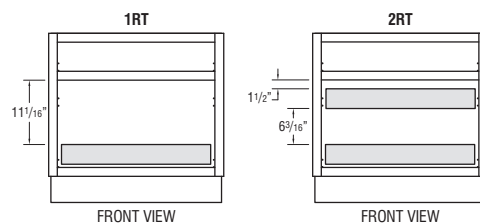

## DESK DOOR DRAWER BASE CABINETS



# CABINET DIMENSIONS

## CABINET AND OVERLAY DIMENSIONS

- 1 1/2" Top and Bottom Rails - Wall and Base Cabinets.
- 1 1/2" Vertical Stiles.
- 3" Center Vertical Rails on Wall and Base Cabinets to Divide Double Door Cabinets 39" Wide and Over.

DOOR AND DRAWER FRONT SIZES	FULL OVERLAY
Face Frame Reveal (see page 9 for more details)	1/4" Reveal Around Doors
Door Size for Base/Wall Cabinets	Frame Opening + 2 1/2"
4 1/2" or 5" High Drawer Opening	6 1/4" Drawer Front
7 1/2" High Drawer Opening	10" Drawer Front
8 5/8" High Drawer Opening	11 3/8" Drawer Front
8 7/8" High Drawer Opening	11 3/8" Drawer Front
12" High Drawer Opening	14 1/2" Drawer Front
14" High Drawer Opening	16 1/2" Drawer Front

## 84" HIGH APPLICATION

Number after Wall Cabinet Represents Height of Cabinet

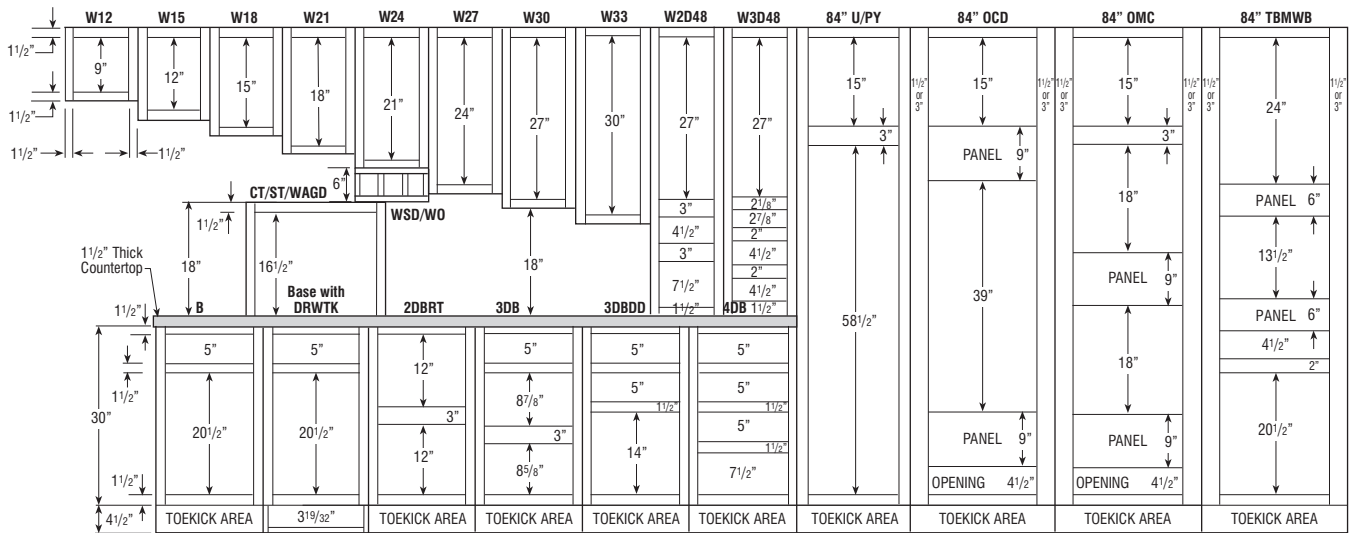

# CABINET DIMENSIONS

## 87" HIGH APPLICATION

Number after Wall Cabinet Represents Height of Cabinet

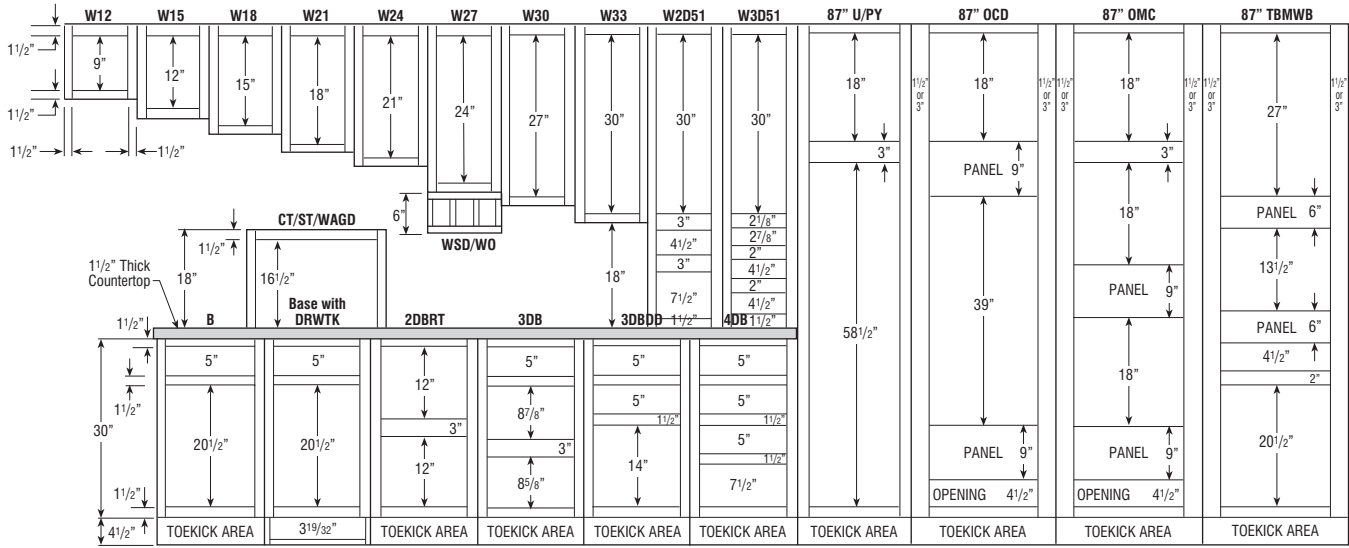

## 90" HIGH APPLICATION

Number after Wall Cabinet Represents Height of Cabinet

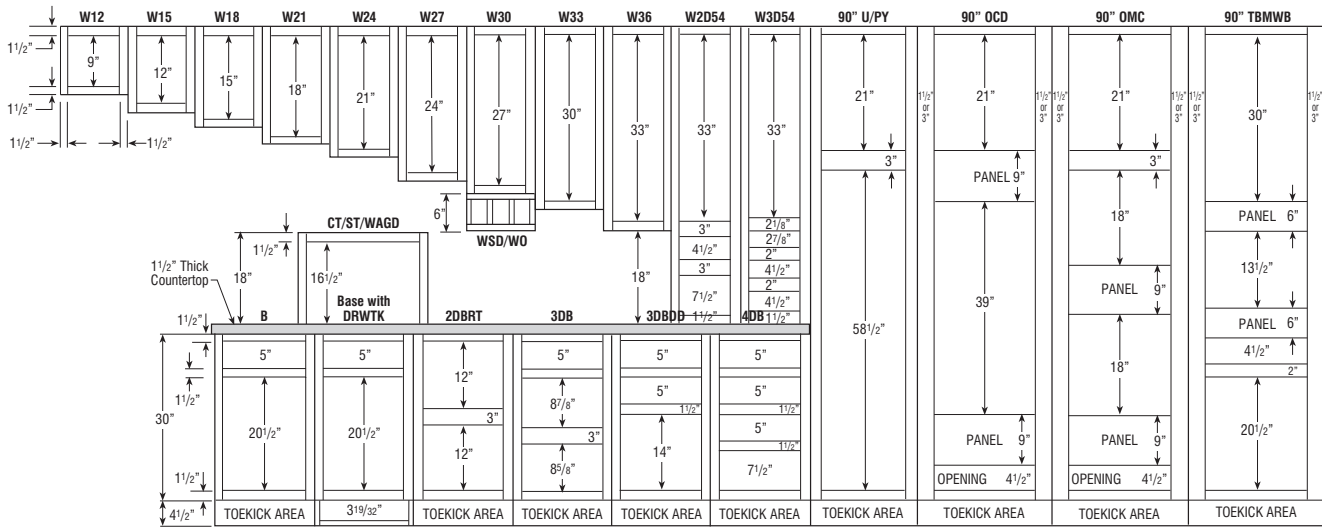

# CABINET DIMENSIONS

## 93" HIGH APPLICATION

Number after Wall Cabinet Represents Height of Cabinet

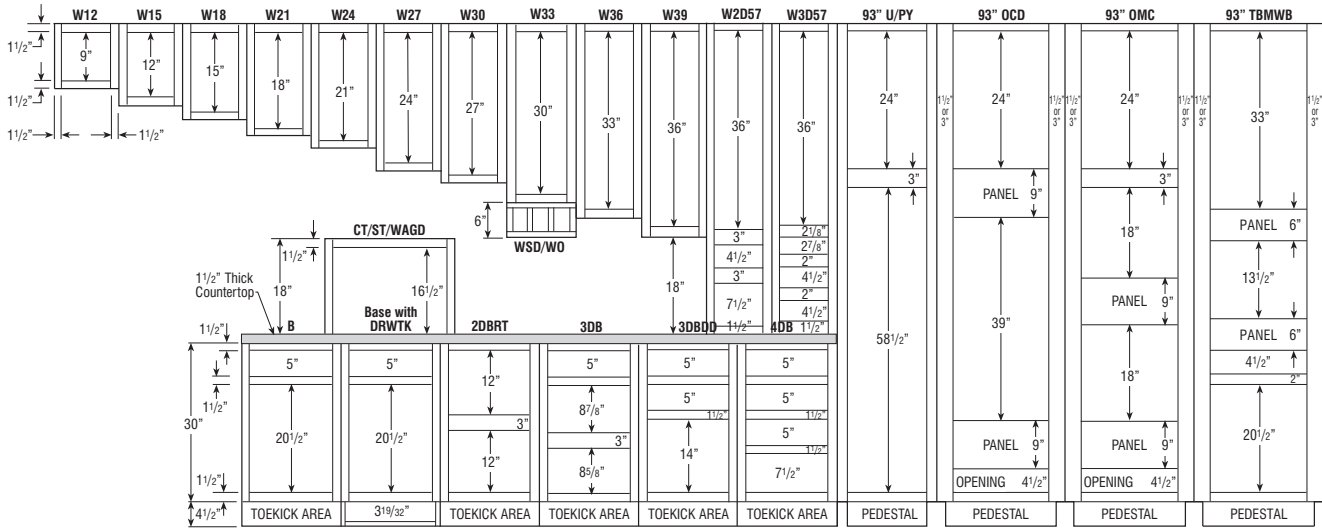

## 96" HIGH APPLICATION

Number after Wall Cabinet Represents Height of Cabinet

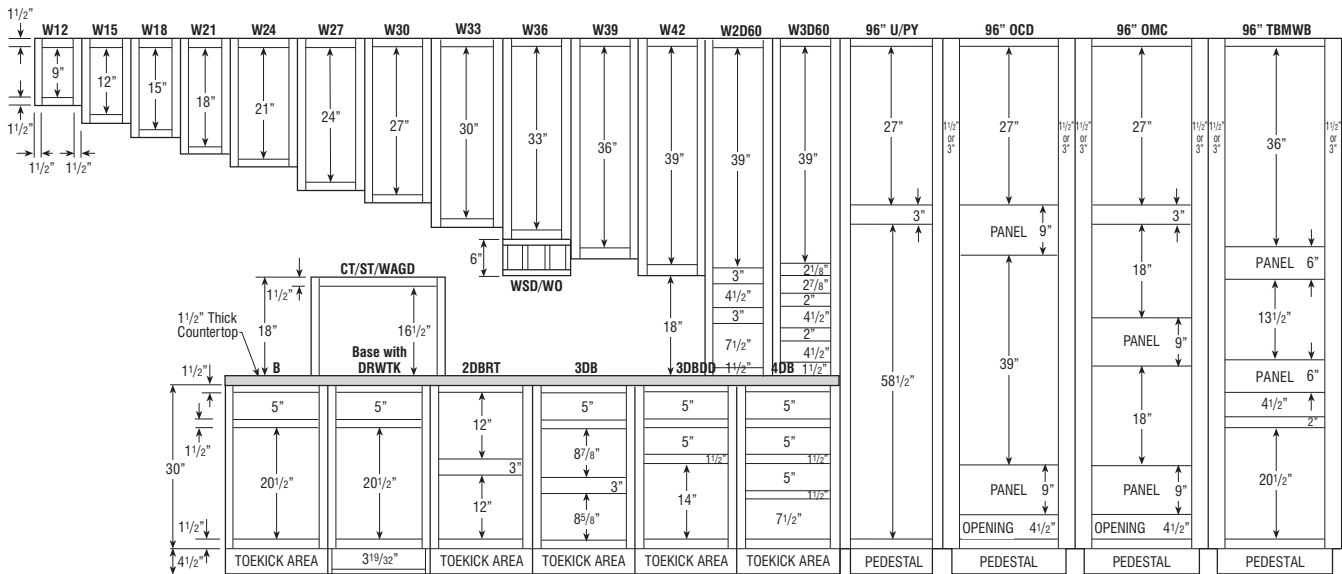

# CABINET DIMENSIONS

## 32 1/2" HIGH UNIVERSAL ACCESS CABINETS, 24" DEEP

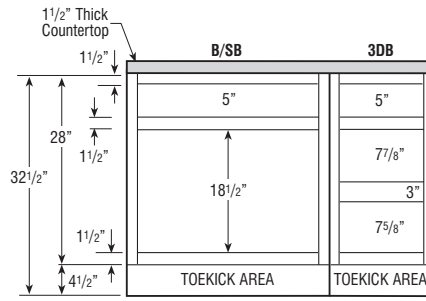

## 32" HIGH UNIVERSAL ACCESS CABINETS, 21" DEEP

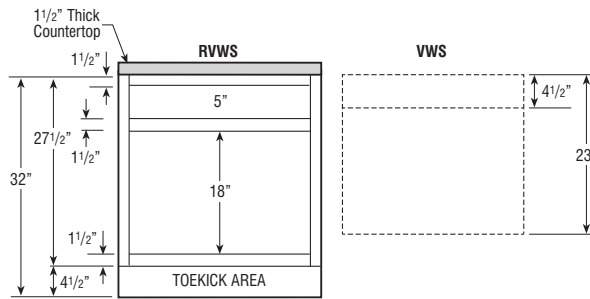

RVWS must be ordered with Vanity Wall Sink (VWS..23), not designed to be a stand-alone unit. See page 221 for more details.

# CABINET DIMENSIONS

## 29" HIGH DESK CABINETS

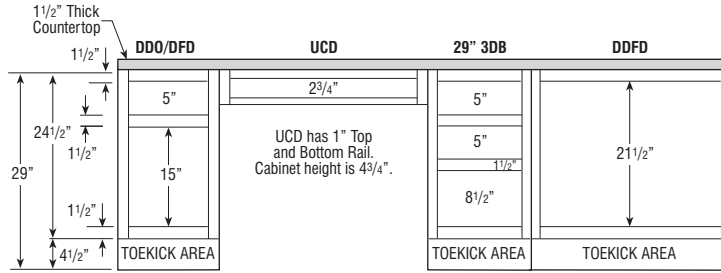

## 32" HIGH VANITY CABINETS

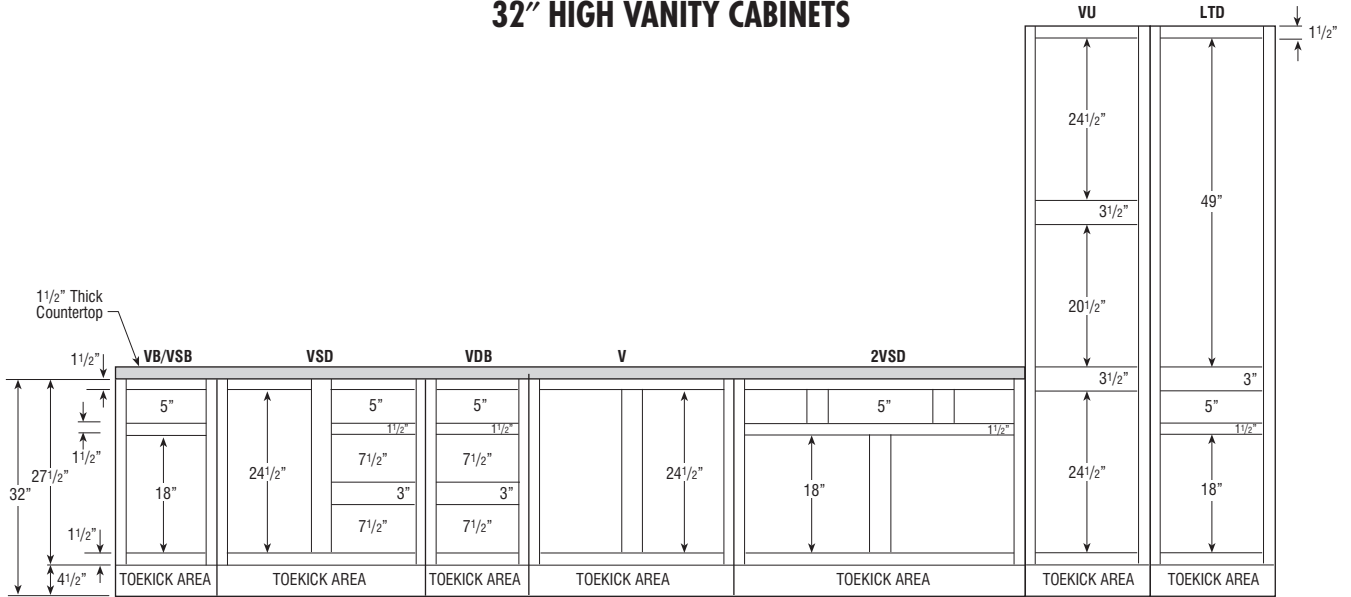

## 34 1/2" HIGH VANITY CABINETS

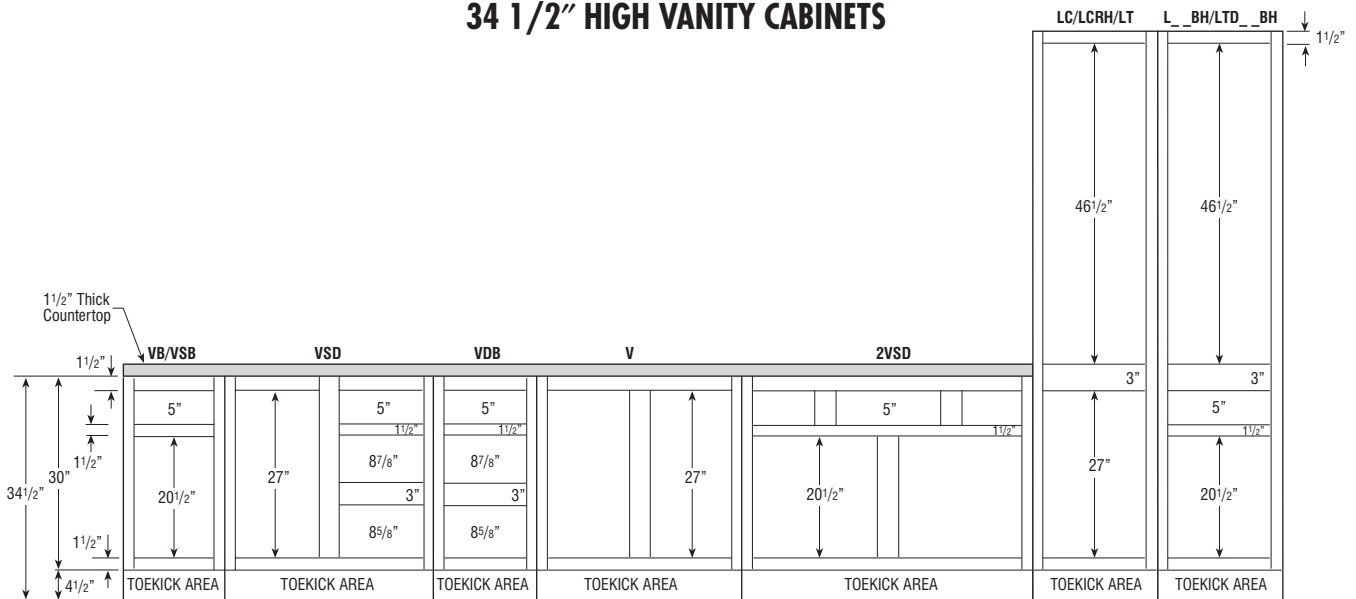

# CABINET DIMENSIONS

## DIMENSIONS FOR CORNER INSTALLATIONS (45° DIAGONAL)

### 12" DEEP CABINETS

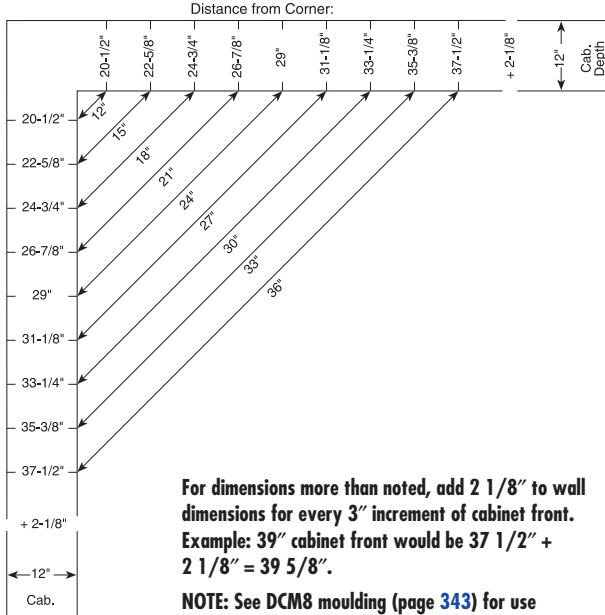

For dimensions more than noted, add 2 1/8" to wall dimensions for every 3" increment of cabinet front.  
 Example: 39" cabinet front would be 37 1/2" + 2 1/8" = 39 5/8".

NOTE: See DCM8 moulding (page 343) for use between cabinets adjacent to 45° corner installations.

### 24" DEEP CABINETS

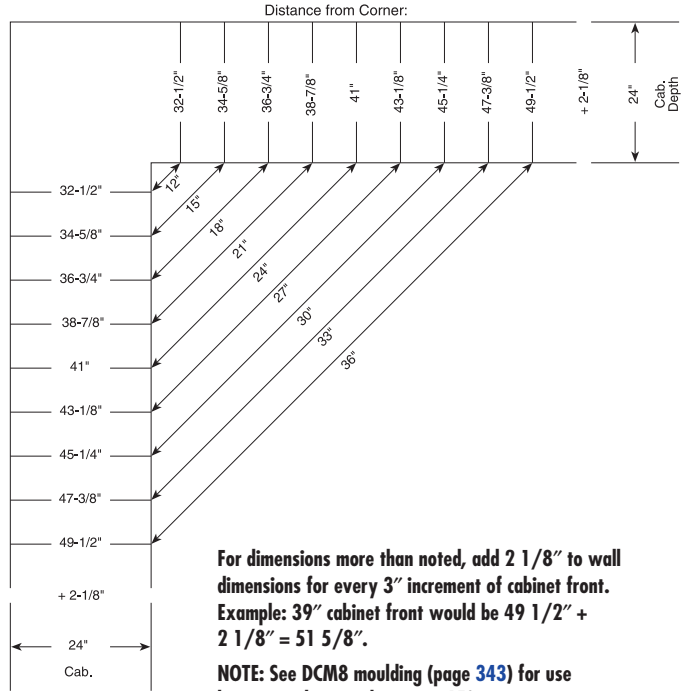

For dimensions more than noted, add 2 1/8" to wall dimensions for every 3" increment of cabinet front.  
 Example: 39" cabinet front would be 49 1/2" + 2 1/8" = 51 5/8".

NOTE: See DCM8 moulding (page 343) for use between cabinets adjacent to 45° corner installations.

## INSTALLATION HEIGHT REQUIREMENTS

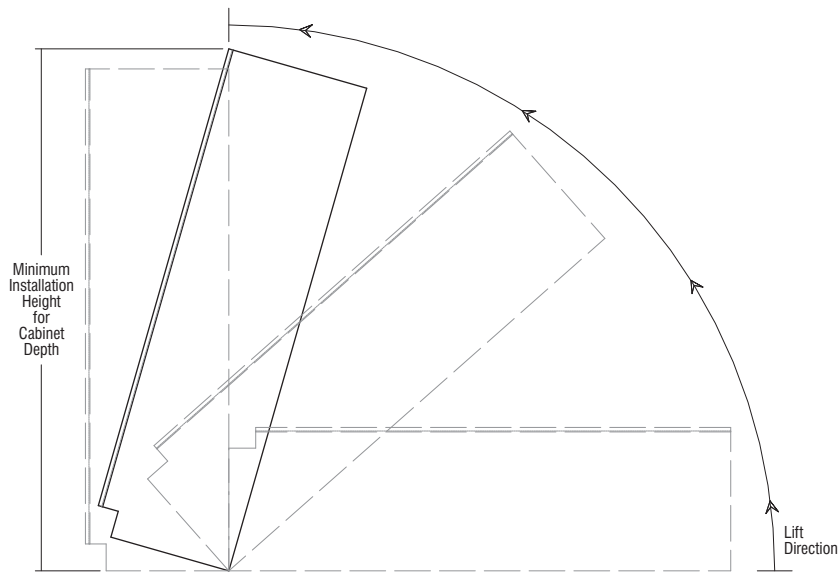

Height of ceiling needs to be considered for installation of tall cabinets. Cabinet height below includes toekick area:

Cabinet Height	Minimum Installation Height for Cabinet Depth					
	12"	15"	18"	21"	24"	27"
84"	84 7/8"	85 11/32"	85 15/16"	86 19/32"	87 3/8"	88 1/4"
87"	87 27/32"	88 5/16"	88 27/32"	89 1/2"	90 1/4"	91 3/32"
90"	90 13/16"	91 1/4"	91 13/16"	92 7/16"	93 5/32"	93 31/32"
93" *	89 5/16"	89 25/32"	90 5/16"	90 31/32"	91 23/32"	92 17/32"
96" *	92 5/16"	92 3/4"	93 9/32"	93 29/32"	94 5/8"	95 13/32"
93" PWT..	—	—	—	95 11/32"	96 1/16"	96 27/32"
96" PWT..	—	—	—	98 9/32"	98 31/32"	99 3/4"

\*Separate pedestal base included with cabinet to be installed after cabinet is in an upright position.

# CABINET DIMENSIONS

## 5-PIECE DRAWER FRONT DIMENSIONS CHART

5-PIECE DRAWER FRONTS	DRAWER FRONT WIDTH	DRAWER FRONT HEIGHT	PANEL FLAT WIDTH	PANEL FLAT HEIGHT
Door 15	8 1/2"	6 1/4"	4"	1 3/4"
Door 15 DFF5PCNR	8 1/2"	6 1/4"	4"	3 1/4"
Door 16 DFF5PC	8 1/2"	6 1/4"	3 1/2"	1 1/4"
Door 17 DFF5PC	8 1/2"	6 1/4"	2 1/2"	1 3/4"
Door 18 DFF5PC	8 1/2"	6 1/4"	2 1/2"	1 3/4"
Door 21 DFF5PC	8 1/2"	6 1/4"	4 1/4"	2"
Door 22 DFF5PC	8 1/2"	6 1/4"	2 1/2"	1 3/4"
Door 23	8 1/2"	6 1/4"	3 1/2"	1 1/4"
Door 24 DFF5PC	8 1/2"	6 1/4"	4 1/4"	2"
Door 26	8 1/2"	6 1/4"	3 1/2"	1 1/4"
Door 28	8 1/2"	6 1/4"	3 1/2"	1 1/4"
Door 29 DFF5PC	8 1/2"	6 1/4"	3 1/2"	1 1/4"
Door 31 DFR5PC	8 1/2"	6 1/4"	1 5/8"	1 1/8"
Door 32	8 1/2"	6 1/4"	2 1/2"	1 3/4"
Door 35 DFF5PC	8 1/2"	6 1/4"	3 1/2"	1 1/4"
Door 37	8 1/2"	6 1/4"	2 1/2"	1 3/4"
Door 38 DFF5PC	8 1/2"	6 1/4"	2 1/2"	1 3/4"
Door 39	8 1/2"	6 1/4"	2 1/2"	1 3/4"
Door 41	8 1/2"	6 1/4"	3 1/2"	1 1/4"
Door 42 DFF5PC	8 1/2"	6 1/4"	4 1/4"	2"
Door 43 DFR5PC	8 1/2"	6 1/4"	1 1/4"	1"
Door 45	8 1/2"	6 1/4"	4 1/4"	2"
Door 46 DFF5PC	8 1/2"	6 1/4"	4"	3 1/4"

Drawer sizes are representative of a 9" wide base cabinet.

# DESIGN CHECKLIST

## CONSTRUCTION OPTIONS

Consider exposed end options:

- Modify exposed cabinet ends to PE or APC.
- Adding a veneer finished end (FB) will age uniformly with the rest of the kitchen.
- Apply 1/4" skin to hide 1/4" reveal. This will allow the ends to age uniformly with the rest of the kitchen and will make it flush.
- Apply decorative door kit (BED, WED, TED). This kit includes 1/4" skin, decorative doors, and screws for field installation.
- Upgrade exposed cabinet ends with Authentic Ends (AUTHL/AUTHR/AUTHB) or Furniture Finished Plywood Ends (FPFB) Modification.

## WOOD AND FINISH CHARACTERISTICS

Review specific details with the customer:

- Mineral Streaks, Birdseye Dots, Grain Variations (especially Rustic Alder and Rustic Hickory).
- Color Variations/Darkening (especially Natural/Light Cherry).
- Finish Variations (Glazes are "consistently inconsistent"), hairline cracks may develop at frame joints on painted frame.
- Underside of cabinets are Natural Maple. Use light rail or cabinet panel edge and skin to hide, especially when designing with peninsula wall cabinets. For cabinets that are bridged between taller adjacent cabinets, specify PFINBTMB modification. See page 47 for more details.

## STORAGE SOLUTIONS

Review storage and usage needs with Customer. See chart on pages 85-86 for more Storage Solutions.

- Cooking Solutions:
  - Wall Spice Rack Cabinet
- Storage Solutions:
  - SuperCabinet™
  - Base Rotating Deep Bin
  - Pegged Dish Organizer
  - Wall Message Center
- Clean-up Center:
  - Trash/Recycle Basket Base

## CLEARANCES

- Add fillers between end cabinets and walls on full overlay door styles.
- Allow space between door/window trim and end cabinets for countertop and top moulding overhang.
- Include refrigerator door hinges in overall refrigerator height when placing cabinets above it.

Maintain a minimum clearance of 3" by pulling blind corners as follows:

- Full Overlay: 1 1/4", Standard Overlay 1/2". (More is needed in certain situations such as when adjacent to an appliance or when using oversized pulls or knobs.)
- Allow sufficient clearance (3") on each side of accessory cabinets (such as roll-out trays, swing-out units, etc.). Doors on these cabinets must open fully for accessories to be functional.
- Ensure the height between the cooktop and range hood is 24" to meet NKBA guidelines.

Qualify customer carefully on upper cabinet/microwave advantages/disadvantages as follows:

- Minimum of 18" from cooktop to upper cabinet/above the range microwave which allows for easy access to either, but less room over back burner.
- Minimum of 21" from cooktop to upper cabinet/microwave which allows for access to large pots on back burner of cooktop, but longer reach to microwave.

## FILLERS

- Place fillers toward end of run where least conspicuous if needed.
- Attach overlay fillers on top of the base, wall, or tall fillers when using full overlay door styles to maintain a consistent reveal. Don't forget to include blind corner fillers.
- Add a filler at least 6" wide to accommodate a decorative onlay when the filler is used as valance.

## VARYING HEIGHTS AND DEPTHS

- Also increase the depth of a wall cabinet run when you increase the height (so moulding on adjacent cabinet will kill into the side of the taller cabinet).
- Skin the sides of tall cabinets to keep adjacent base and wall cabinets out from reveal of tall cabinet.
- Add increased depth on tall end panels for a built-in look for deep refrigerators.
- Account for the additional support needed for wall cabinets with a depth of 18" or greater. This can be achieved by installing a soffit or end panels.

## MATCHING INTERIOR CABINETS/GLASS OPTIONS

- Verify cut-for-glass or mullion door option is available on desired cabinet size. (See pages 60-63 for available cut-for-glass/mullion door sizes.)
- Verify glass insert option is available for desired cut-for-glass door size chosen.
- Verify matching interior option has been selected for all open or glass cabinets.
- Verify mullion door lite grid matches customer expectations.

## MOULDINGS

- Order rosettes and plinths in beaded or fluted styles to match fillers.
- Verify correct amount of crown moulding has been ordered.
- Order toekick caps.
- Order extra scribe.

## ISLANDS AND PENINSULAS

- Consider standard height bars are 34 1/2" tall and require 19" knee space. Raised bars are 42" tall.
- Consider base peninsula cabinets (P) are 24 1/4" deep and require 12" of knee space. Use back panels/doors to flush non-P cabinets with P cabinets.
- Use recess toe on sides and back or BBM8 when using multiple base cabinets to create an island.
- Use outside corner moulding if a skin is exposed on the back of the island.

## APPLIANCES

- Note for all consumers, appliances are not included with any cabinetry product.
- Do not place dishwashers next to diagonal front cabinet (interference) or next to a range (no countertop support).
- Verify refrigerator door has enough clearance to open beyond 90° so refrigerator drawers can be utilized. Refer to appliance manufacturer's specs.
- Add TF696FH, as it may be required to frame around built-in microwave ovens and other built-in items. Refer to appliance manufacturer's specs.
- Order appliance panels.

## SPECIAL CONSIDERATIONS

- Consider V-groove skins and/or decorative doors on exposed cabinet sides in glazed kitchen.

## MISCELLANEOUS

- Order full size touch-up kit (mini touch-up kit included with standard sink base).

## TIPS TO THE INSTALLER

#10 x 2 1/2" installation screws are furnished and packaged inside all cabinets. Proper wall stud or ceiling joist installation is essential for Wall and Peninsula cabinets to support weight. Whenever possible, cabinets should be attached to each other for additional strength. Excessive weight should not be put on cabinets hung by themselves. Shimming may be required to ensure proper alignment. Wallboard alone is not strong enough to support the cabinets.

Our Warranty does not cover damage caused by improper installation. Please be sure to install cabinets properly. If you have questions, please contact your representative or customer service.



## kitchen planning guidelines

### DOOR/ENTRY

- Door opening should be at least 32" wide, requiring a minimum 2' 10" wide door.

### DOOR INTERFERENCE

- Entry door should not interfere with safe appliance operation or appliance doors.

### DISTANCE BETWEEN WORK CENTERS

- With three work centers, the total distance traveled should not be more than 26' with no single leg of the triangle less than 4' or more than 9'.
- With more than three work centers, each additional travel distance to another work center should be no less than 4' or more than 9'. Each leg is measured from the center-front of the appliance/sink. No work triangle leg should intersect an island/peninsula by more than 12".

### SEPARATING WORK CENTERS

- A tall obstacle should not separate two primary work centers. A properly recessed tall corner unit is acceptable.

### WORK TRIANGLE TRAFFIC

- Major traffic patterns should not cross through the basic work triangle.

### WORK AISLE

- The work aisle should be at least 42" for one cook and at least 48" for multiple cooks.

### WALKWAY

- The walkway width should be at least 36".

### TRAFFIC CLEARANCE AT SEATING

- Allow 32" of clearance from the table to wall/obstacle if no traffic passes behind a seated diner. If traffic passes behind the diner, allow at least 36" to edge past or 44" to walk past.

### SEATING CLEARANCE

- 30" high tables/counters should allow a 24" wide by 18" deep space for each seated diner and at least 18" knee space.
- 36" high counters should allow a 24" wide by 15" deep space for each seated diner and at least 15" kneespace.
- 42" high counters should allow a 24" wide by 12" deep space for each seated diner and at least 12" kneespace.

### CLEAN-UP/PREP SINK PLACEMENT

- With only one sink, locate it adjacent to or across from the cooking surface and refrigerator.

### CLEAN-UP/PREP SINK LANDING AREA

- Include at least a 24" wide landing space on one side of the sink and 18" on the other.
- If all the countertop at the sink is not the same height, plan a 24" landing space on one side of the sink and 3" of countertop frontage on the other, both at the same height of the sink.

### PREPARATION/WORK AREA

- Include a section of countertop at least 36" wide x 24" deep next to the sink for a work area.

### DISHWASHER PLACEMENT

- Nearest edge of dishwasher should be within 36" of nearest edge of sink. Provide at least 21" of standing space between the edge of the dishwasher and countertop frontage/appliances/cabinets which are placed at a right angle to the dishwasher.

### WASTE RECEPTACLES

- Include at least 2 waste receptacles, one near the sink and the other nearby for recycling.

### AUXILIARY SINK

- Provide at least 3" of countertop frontage on one side of the auxiliary sink and 18" on the other side, both at the same height as the sink.

### REFRIGERATOR LANDING AREA

- Include at least 15" of landing area on the handle side of the refrigerator, 15" on either side of a side-by-side refrigerator, 15" of landing space which is no more than 48" across from the front of the refrigerator, and 15" above or adjacent to any under-counter style refrigerator.

### COOKING SURFACE LANDING AREA

- Include a minimum of 12" of landing area on one side of the cooking surface and 15" on the other.
- If cooking surface is at a different countertop height than the rest of the kitchen, then the 12" and 15" landing areas must be the same height as the cooking surface.
- For safety reasons, in an island or peninsula situation, the countertop should extend a minimum of 9" behind the cooking surface if the counter height is the same height as the cooking surface.

### COOKING SURFACE CLEARANCE

- Allow 24" between the cooking surface and a protected noncombustible surface above it.
- At least 30" of clearance is required between the cooking surface and an unprotected/combustible surface above it.
- If a microwave/hood combination is used, then the manufacturer's specifications should be followed.

### COOKING SURFACE VENTILATION

- A correctly sized, ducted ventilation system is recommended for all cooking surface appliances. The recommended minimum is 150 CFM.
- Code requires that the manufacturer's specifications be followed. Minimum exhaust rate for a ducted hood is 100 CFM and must be ducted to the outside.
- Make-up air may need to be provided. Refer to local codes.

### COOKING SURFACE SAFETY

- Do not locate cooking surface under an operable window.
- Window treatments above cooking surface should not use flammable materials.
- Place a fire extinguisher near the kitchen exit away from cooking equipment.

### MICROWAVE OVEN PLACEMENT

- The ideal location for the bottom of the microwave is 3" below the principle user's shoulder, but no more than 54" above the floor.

### MICROWAVE LANDING AREA

- Provide at least 15" above, below, or adjacent to the handle side of a microwave oven.

### OVEN LANDING AREA

- Include at least 15" next to or above the oven.
- A 15" landing area that is not more than 48" away is also acceptable as long as the oven does not open into a walkway.

### COMBINING LANDING AREAS

- If two landing areas are adjacent to one another, determine a new minimum for the two by taking the longer of the two and adding 12".

*continued*

## kitchen planning guidelines (continued)

### COUNTERTOP SPACE

- A total of 158" of countertop frontage, 24" deep, with at least 15" clearance above is needed to accommodate all landing, preparation, work, and storage areas.

### COUNTERTOP EDGES

- Clipped or round corners, rather than sharp edges, are recommended on all counters.

### STORAGE

- The recommended total shelf/drawer frontage for a small kitchen (less than 150 square feet) is 1400", for a medium kitchen (151 to 350 square feet) is 1700", and for a large kitchen (greater than 350 square feet) is 2000".

Sizes:	S	M	L
Wall	300"	360"	360"
Base	520"	615"	660"
Drawer	360"	400"	525"
Pantry	180"	230"	310"
Misc.	40"	95"	145"

- The totals for wall, base, drawer, and pantry shelf/drawer frontage can be adjusted upward or downward as long as the recommended total stays the same.

### STORAGE AT CLEAN-UP/PREP SINK

- The recommended total for a small kitchen is 400", a medium kitchen is 480", a large kitchen is 560", and should be located within 72" of the centerline of the main clean-up/prep sink.

### CORNER CABINET STORAGE

- At least one corner cabinet should include a functional storage device.

### ELECTRICAL RECEPTACLES

- GFCI (Ground-Fault-Circuit-Interrupter) protection is required on all receptacles servicing countertop surfaces within the kitchen.

### LIGHTING

- Every work surface should be well illuminated. At least one wall switch-controlled light must be placed at the entrance.
- Window/skylight area, equal to at least 8% of the total square footage of the kitchen, or a total living space which includes a kitchen, is required.

## bathroom planning guidelines

### DOOR/ENTRY

- Doorway opening should be at least 32", requiring a minimum 2' 10" wide door.

### DOOR INTERFERENCE

- The door area should include clear floor space for maneuvering which varies according to the type of door and the direction of the approach.

### CEILING HEIGHT

- Bathroom floor to ceiling minimum height is 80". A shower or tub with a shower head shall have a minimum floor to ceiling height of 80" above a minimum area 30" x 30" at the shower head.

### CLEAR SPACE

- Plan a clear space of 30" from the front edge of all fixtures to any opposite bath fixture, wall, or obstacle.
- A minimum space of at least 21" is required in front of a lavatory, toilet, bidet, and tub, with a 24" minimum space in front of a shower entry.

### SINGLE LAVATORY PLACEMENT

- The distance from the centerline of the lavatory to the sidewall/tall obstacle should be at least 20".
- The minimum distance required is 15". The minimum distance required between a wall and the edge of a lavatory is 4".

### DOUBLE LAVATORY PLACEMENT

- The distance between the centerlines of two lavatories should be at least 36".
- The minimum distance required is 30".
- The minimum distance required between the edges of two lavatories is 4".

### LAVATORY/VANITY HEIGHT

- The height for a lavatory varies from 32" to 43" to fit the user.

### COUNTERTOP EDGES

- Clipped or round corners, rather than sharp edges, are recommended on all counters.

### SHOWER SIZE

- The interior shower size should be at least 36" x 36". The minimum interior shower size required is 30" x 30".

### STORAGE

- Provide adequate, accessible storage for toiletries, bath linens, grooming and general bathroom supplies.
- Storage of frequently used items should be 15" to 48" above floor.

### ELECTRICAL RECEPTACLES

- All GFCI receptacles should be located at electrical appliance points of use.

**Load bearing floors and shelves meet KCMA standards of 15 lbs. per square foot. Warranty does not cover overloading beyond this point.**

To view a complete and updated list of the NKBA Guidelines, visit <https://nkba.org/info/guidelines>

© Copyright 2010 National Kitchen & Bath Association

# STORAGE SOLUTIONS REFERENCE CHART

Wall Cabinets	Description	3"	6"	9"	12"	15"	18"	21"	24"	27"	30"	33"	36"	39"	42"	45"	48"	Page
W36__SHLFPD	Wall Shelf Pull-down																	139
WBPCO___OL	Wall Box Column Pull-outs (Plain, Overlay)	•	•															137, 138
WEAS_____	Wall Easy Access Storage Cabinets					•	•				•	•						110
WMC_____	Wall Message Center	•																143
WSC_____	Wine Storage Cabinet				•	•	•	•										141
WSP_____	Wall Spice Pull-outs			•	•													139
WSR_____	Wall Spice Rack Cabinets						•	•										140
Base Cabinets	Description	3"	6"	9"	12"	15"	18"	21"	24"	27"	30"	33"	36"	39"	42"	45"	48"	Page
2DB__RT	Two Drawer Bases w/Roll Tray						•	•	•	•	•	•	•					200
2DB36PDO	Two Drawer Base w/Pegged Dish Organizer												•					199
2DB36RTPDO	Two Drawer Base w/Roll Tray & Pegged Dish Organizer												•					200
3DB__WTCD	Three Drawer Bases w/Wood Tiered Cutlery Divider Drawer					•	•	•	•		•	•	•					202
3DBDD__	Three Drawer Base Buffet w/Deep Drawer										•	•	•					203
3DBDD__	Three Drawer Bases w/Deep Drawer								•	•	•	•	•					203
4DB__WTCD	Four Drawer Bases w/Wood Tiered Cutlery Divider Drawer					•	•	•	•		•	•	•					204
B__FMIXSC	Base Cabinets w/Mixer Shelf						•	•	•									172
B__FSCO	Base w/Food Storage Container Organizer						•	•										169
B__PS	Pots & Pans Organizer Bases w/Drawer								•		•	•						168
B__RTWTCD	Bases w/Wood Tiered Cutlery Divider Drawer & Roll Tray					•	•	•	•				•					167
B__TDRO	Bases with Roll-out Tray Divider				•	•												171
B__WTCD	Bases w/Wood Tiered Cutlery Divider Drawer					•	•	•	•		•	•	•					157
B18CWP__	Base w/Can and Wine Bottle Pull-outs						•											170
B18FHCWP__	Full Height Base w/Can and Wine Bottle Pull-outs						•											170
BBCPO___OL	Base Box Column Pull-outs (Plain, Overlay)	•	•															212
BBP24	Base Bin Tray Pull-out								•									207
BBP24FH	Base Bin Tray Pull-out Full Height								•									208
BBP24FHFPD	Base Bin Tray Pull-out Full Height w/Pet Feeding Drawer								•									208
BBP24FPD	Base Bin Tray Pull-out w/Pet Feeding Drawer								•									208
BC__PO	Base Corners w/Pull-out															•	•	186
BCFW__PO	Base Corners Full Width w/Pull-out															•	•	187
BCFW48CPO	Base Corner Full Width w/Curved Pull-out																•	187
BCFW48SP	Base Cabinet Full Width w/Roll Trays & Swing-out																•	188
BCOPP12	Base Container Organizer Pantry Pull-out				•													211
BMC24	Base Message Center	•																213
BPP__	Base Pantry Pull-outs			•	•													210
BPPP__	Base Pots & Pans Pull-outs								•		•							168, 169
BPT__WB	Base Paper Towel Cabinet w/Wastebasket						•	•										205
BPT__WBFH	Base Paper Towel Cabinet w/Wastebasket Full Height						•	•										207
BRDB36	Base Rotating Deep Bin												•					195
BSC30PR, R, RP, RS, SR	SuperCabinet™											•						161
BSC36PRP, PRS, SRP, SRS	SuperCabinet™												•					163
BDPP12	Base Tray Divider Pantry Pull-out				•													210
BUPP__	Base Utensil Pantry Pull-out			•	•													211
BUPPKB__	Base Utensil Pantry Pull-out w/Knife Block				•	•												212
BV2SC30PR, RP, RS, SR	SuperCabinet™ Version 2											•						162
BV2SC36PRP, PRS, SRP, SRS	SuperCabinet™ Version 2												•					164
BWB__	Base Wastebaskets					•	•	•										205
BWB__FH	Base Wastebaskets Full Height					•	•	•										206
CNTYSB__CM	Country Sink Base w/CabMat™										•	•	•					181
LSP36	Lazy Susan Pull-out												•					196
SB__CM, SCM, STCM, STSCM	Sink Base w/CabMat™										•	•	•					173, 176, 177, 178
SB__D	Sink Bases w/Drawers Below								•	•	•	•	•	•	•	•	•	178
SB__S	Sink Base SuperCabinet™										•	•	•					177
SB__STS	Sink Base SuperCabinet™ w/Tilt-out Trays										•	•	•					177
SLSCR__	Super Lazy Susans w/Chrome Rail											•	•					193
SLSCR__	Asymmetrical Super Lazy Susans w/Chrome Rail											•	•					195
Tall Cabinets	Description	3"	6"	9"	12"	15"	18"	21"	24"	27"	30"	33"	36"	39"	42"	45"	48"	Page
PTU___24	Pantry Top Units					•	•	•	•		•	•	•					234
PY36__24	Pantry Units												•					236
TPP__24	Tall Pantry Pull-outs			•	•	•	•											235
UOC24__6	Utility Organizer Cabinet		•															231
UOCDZ24__9	Utility Organizer Drop Zone Cabinet								•									232

• Available widths

continued

# STORAGE SOLUTIONS REFERENCE CHART

Vanity Cabinets	Description	3"	6"	9"	12"	15"	18"	21"	24"	27"	30"	33"	36"	39"	42"	45"	48"	Page
L188421BH	Linen Tall w/Drawer and Removable Hamper						•											296
LC188421	Linen Closet						•											295
LCRH188421	Linen Closet w/Removable Hamper						•											295
VBH183421	Vanity Hamper w/Drawer						•											294
VBWB153421	Vanity Base Wastebasket					•												281
VGPO123421	Vanity Grooming Pull-out				•													283
VH183221FH	Vanity Hamper						•											294
VMP_32.5	Vanity Mirror w/Side Pull-outs								•		•							300
VP93421	Vanity Pull-out			•														283
VS_21U	Vanity Sink Bases w/U-shaped Pull-out Trays										•		•					277
VS_3421WB	Vanity Sink Bases w/Wastebasket								•		•							277
VSSB_3421ST	Vanity Sink Base SuperCabinet™ w/Tilt-out Trays										•	•	•					278
VSSB_3421STWB	Vanity Sink Base SuperCabinet™ w/Tilt-out Trays and Wastebasket										•	•	•					277
VWB15_21	Vanity Wastebasket Full Height					•												282
VWB15_21RT	Vanity Wastebasket Full Height w/Roll Tray					•												282, 283
VWH_23.521U	Vanity Wall Hung Double Door w/U-shaped Pull-outs										•		•					298
Modifications	Description	3"	6"	9"	12"	15"	18"	21"	24"	27"	30"	33"	36"	39"	42"	45"	48"	Page
CMAT1 (Base, Universal)	CabMat™										•	•	•					50
CMAT2 (Vanity)	CabMat™								•	•	•	•	•					50
DRWTK	Toe-kick Drawer						•	•	•	•	•	•	•					57

• Available widths

WALL CABINET NOMENCLATURE

All Wall Cabinets are 12" deep unless otherwise noted.

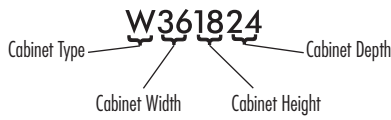

MODIFICATIONS GRID KEY

- Available
- STD Standard on these cabinets
- 5 DAY** 5 Day Express Response Item

CUSTOM MODIFICATIONS				CONSTRUCTION UPGRADES		DOOR OPTIONS	
Mod.	Description	Mod.	Description	Mod.	Description	Mod.	Description
ADDTK*	Add Toekick	EXBKR	End Extended Back - Right	INVFRM	Inverted Frame	ALF	Aluminum Frame Doors
AUTHB	Authentic Ends - Both	EXL	Extended Sillie - Left	MIP	Matching Interior Plywood	CG, CG.BTM, CG.TOP	Cut-for-glass Doors
AUTHL	Authentic End - Left	EXR	Extended Sillie - Right	P	Peninsula	DPSRR	Door Panel - Solid Reverse Raised
AUTHR	Authentic End - Right	FB	Finished Ends	PFINBTMB	Prepare Cabinet for Finished Bottom	MD, MD.BTM, MD.TOP	Mullion Doors
CBO	Cabinet Box Only	FFDL	Face Frame and Door on End - Left	RD	Reduced Depth	MFO	Modified Full Overlay
CCO	Cabinet Case Only			TD	Tray Dividers		
CFNTO	Cabinet Front Only	FFDR	Face Frame and Door on End - Right	TVRAV	Valance Top Rail, Arch		
CFRMO	Cabinet Frame Only			TVRFV	Valance Top Rail, Furniture		
CND	Cabinet with No Door, with Drawer	FPEB	Furniture Finished Plywood Ends	TVRVV	Valance Top Rail, Straight		
EXBKL	End Extended Back - Left	ID	Increased Depth	WLI	White Laminate Interior		

\*ADDTK available with compatible toekick modifications. See the Modification/Upgrade Compatibility Chart on page 37 for details.

WALL TOP HINGE, 9" HIGH

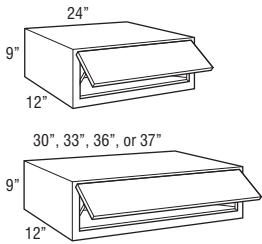

WTH249

WTH309

WTH339

WTH369

WTH379

- 24" Wide (WTH249) uses standard configuration doors with vertical center panel grain. Door 19, Door 36, and Door 44 have a standard vertical grain pattern. Door 33 has a standard horizontal grain pattern. See page 9 for more details.
- 30"-37" Wide (WTH309-WTH379) use non-standard configuration doors where grain on center panels and Door 44 slab doors runs horizontally, and non-miter door rail configuration is unique from adjacent cabinet doors. Door 19 and Door 36 have a standard vertical grain pattern. Door 33 has a standard horizontal grain pattern. See page 9 for more details.
- Not available on Door 46.
- Glass not available.
- Door lift mechanism tension can be field adjusted.
- Depth can be reduced to a minimum of 9".
- Door will open a maximum of 107°. For applications close to a ceiling, door angle can be restricted to 75° with a Wall Top Hinge Restriction Clip (WTHRESCLIP75, see page 382).
- Door will not have standard hinges and may have visible 3/16" diameter holes used during finish processing.
- Lift mechanism not available for order for field installation, only available factory installed.

Custom Modifications

ADDTK	AUTH	CBO	CCO	CFNTO	CFRMO	CND	EXBK	EX	FB	FFD	FPEB	ID	INVFRM	MIP	P	PFINBTMB	RD	TD	TVR_V	WLI
			•		•		•	•	•		•	•		•		•	•			•

Construction Upgrades

APC	PE
•	•

Door Options

ALF	CG	CG.BTM	CG.TOP	DPSRR	MD	MD.BTM	MD.TOP	MFO
				•				

**WALL TOP HINGE REFRIGERATOR,  
9" HIGH, 24" DEEP**

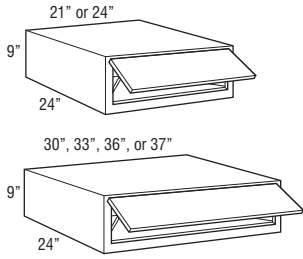

**WTH21924**  
**WTH24924**

**WTH30924**  
**WTH33924**  
**WTH36924**  
**WTH37924**

- 21"-24" Wide (WTH21924-WTH24924) use standard configuration doors with vertical center panel grain. Door 19, Door 36, and Door 44 have a standard vertical grain pattern. Door 33 has a standard horizontal grain pattern. See page 9 for more details.
- 30"-37" Wide (WTH30924-WTH37924) use non-standard configuration doors where grain on center panels and Door 44 slab doors runs horizontally, and non-miter door rail configuration is unique from adjacent cabinet doors. Door 19 and Door 36 have a standard vertical grain pattern. Door 33 has a standard horizontal grain pattern. See page 9 for more details.
- Not available on Door 46.
- 24" deep cabinets must be fully supported by screws installed in a structural member in the ceiling or soffit, and into adjacent cabinets or tall panels.
- Load limit is 15 lbs. per square foot of load bearing surface.
- Glass not available.
- Two WTH21924 can be used to create a 42" wide solution for wide refrigerator applications.
- Two WTH24924 can be used to create a 48" wide solution for wide refrigerator applications.
- Door lift mechanism tension can be field adjusted.
- Depth can be reduced to a minimum of 9".
- Door will open a maximum of 107°. For applications close to a ceiling, door angle can be restricted to 75° with a Wall Top Hinge Restriction Clip (WTHRESCUP75, see page 382).
- Door will not have standard hinges and may have visible 3/16" diameter holes used during finish processing.
- Lift mechanism not available for order for field installation, only available factory installed.

**Custom Modifications**

ADDTK	AUTH	CBO	CCO	CFNTO	CFRMO	CND	EXBK	EX	FB	FFD	FPEB	ID	INVFRM	MIP	P	PFINBTMB	RD	TD	TVR_V	WLI	
			•			•		•	•	•		•	•		•		•				•

**Construction Upgrades**

APC	PE
•	•

**Door Options**

ALF	CG	CG.BTM	CG.TOP	DPSRR	MD	MD.BTM	MD.TOP	MFO
				•				

**WALL SINGLE DOOR, 12" HIGH**

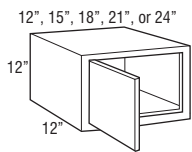

**W1212 L or R**  
**W1512 L or R**  
**W1812 L or R**  
**W2112 L or R**  
**W2412 L or R**

**Custom Modifications**

ADDTK	AUTH	CBO	CCO	CFNTO	CFRMO	CND	EXBK	EX	FB	FFD	FPEB	ID	INVFRM	MIP	P	PFINBTMB	RD	TD	TVR_V	WLI	
•*	•		•	•	•		•	•	•		•	•		•	•	•	•				•

\*Not available on 21" and 24" wide

**Construction Upgrades**

APC	PE
•	•

**Door Options**

ALF	CG	CG.BTM	CG.TOP	DPSRR	MD	MD.BTM	MD.TOP	MFO
•†	•			•				•

†Not available on 12", 21", and 24" wide

## WALL DOUBLE DOOR, 12" HIGH

21", 24", 27", 30", 31 1/2", 33", 34", 36", or 37"

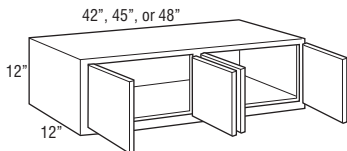
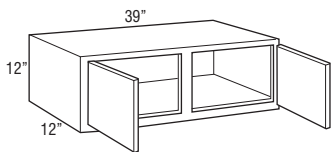
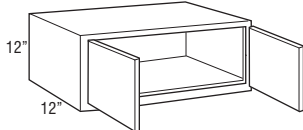

W2112  
W2412  
W2712  
W3012  
W31.512  
W3312  
W3412  
W3612  
W3712  
W3912

W4212  
W4512  
W4812

- 42" or wider will feature four doors.

### Custom Modifications

ADDTK	AUTH	CBO	CCO	CFNTO	CFRMO	CND	EXBK	EX	FB	FFD	FPEB	ID	INVFRM	MIP	P	PFINBTMB	RD	TD	TVR_V	WLI
•	•		•	•	•		•	•	•		•	•		•	•		•	•		•

### Construction Upgrades

APC	PE
•	•

### Door Options

ALF	CG	CG.BTM	CG.TOP	DPSRR	MD	MD.BTM	MD.TOP	MFO
	•			•				•

## WALL TOP HINGE, 12" HIGH

18", 21", or 24"

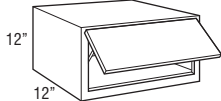

30", 33", 36", or 37"

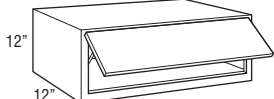

WTH1812  
WTH2112  
WTH2412  
WTH3012  
WTH3312  
WTH3612  
WTH3712

- 18"-24" Wide (WTH1812-WTH2412) use standard configuration doors with vertical center panel grain. Door 19, Door 36, and Door 44 have a standard vertical grain pattern. Door 33 has a standard horizontal grain pattern. See page 9 for more details.
- 30"-37" Wide (WTH3012-WTH3712) use non-standard configuration doors where grain on center panels and Door 44 slab doors runs horizontally, and non-miter door rail configuration is unique from adjacent cabinet doors. Door 19 and Door 36 have a standard vertical grain pattern. Door 33 has a standard horizontal grain pattern. See page 9 for more details.
- Not available on Door 46.
- Art Glass not available.
- Cabinet may utilize one or two lift mechanisms depending on door size and weight. Door lift mechanism tension can be field adjusted.
- Depth can be reduced to a minimum of 9".
- Door will open a maximum of 107° due to hinges. For applications close to a ceiling, door angle can be restricted to 86° with a Hinge Angle Restriction Clip (HINGERESCLIP, see page 382).
- Lift mechanisms and mounting brackets will be visible if used with transparent textured glass.
- Lift mechanism not available for order for field installation, only available factory installed.

### Custom Modifications

ADDTK	AUTH	CBO	CCO	CFNTO	CFRMO	CND	EXBK	EX	FB	FFD	FPEB	ID	INVFRM	MIP	P	PFINBTMB	RD	TD	TVR_V	WLI
	•		•		•		•	•	•		•	•		•	•		•	•		•

### Construction Upgrades

APC	PE
•	•

### Door Options

ALF	CG	CG.BTM	CG.TOP	DPSRR	MD	MD.BTM	MD.TOP	MFO
• <sup>†</sup>	•			•				•

<sup>†</sup>Available only on 30" and 36" wide

**WALL REFRIGERATOR SINGLE DOOR, 12" HIGH, 24" DEEP**

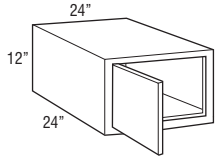

**W241224 L or R**

- 24" deep cabinets must be fully supported by screws installed in a structural member in the ceiling or soffit, and into adjacent cabinets or tall panels.
- Load limit is 15 lbs. per square foot of load bearing surface.

**Custom Modifications**

ADDTK	AUTH	CBO	CCO	CFNTO	CFRMO	CND	EXBK	EX	FB	FFD	FPEB	ID	INVFRM	MIP	P	PFINBTMB	RD	TD	TVR_V	WLI
	•		•	•		•		•	•		•	•		•		•	•			•

**Construction Upgrades**

APC	PE
•	•

**Door Options**

ALF	CG	CG.BTM	CG.TOP	DPSRR	MD	MD.BTM	MD.TOP	MFO
	•			•				•

**WALL REFRIGERATOR DOUBLE DOOR, 12" HIGH, 24" DEEP**

24", 27", 30", 31 1/2", 33", 34", 36", or 37"

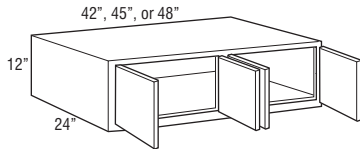
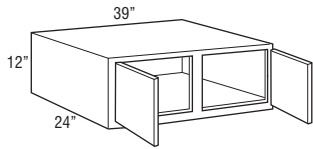
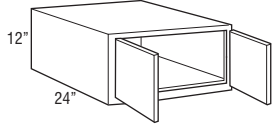

**W241224**

**W271224**

**W301224**

**W31.51224**

**W331224**

**W341224**

**W361224**

**W371224**

**W391224**

**W421224**

**W451224**

**W481224**

- 24" deep cabinets must be fully supported by screws installed in a structural member in the ceiling or soffit, and into adjacent cabinets or tall panels.
- Load limit is 15 lbs. per square foot of load bearing surface.
- 42" or wider will feature four doors.

**Custom Modifications**

ADDTK	AUTH	CBO	CCO	CFNTO	CFRMO	CND	EXBK	EX	FB	FFD	FPEB	ID	INVFRM	MIP	P	PFINBTMB	RD	TD	TVR_V	WLI
•	•		•	•		•	•	•			•	•		•		•	•			•

**Construction Upgrades**

APC	PE
•	•

**Door Options**

ALF	CG	CG.BTM	CG.TOP	DPSRR	MD	MD.BTM	MD.TOP	MFO
	•			•				•



## WALL TOP HINGE REFRIGERATOR, 12" HIGH, 24" DEEP

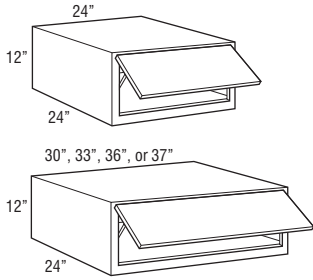

WTH241224

WTH301224

WTH331224

WTH361224

WTH371224

- 24" Wide (WTH241224) uses standard configuration doors with vertical center panel grain. Door 19, Door 36, and Door 44 have a standard vertical grain pattern. Door 33 has a standard horizontal grain pattern. See page 9 for more details.
- 30"-37" Wide (WTH301224-WTH371224) use non-standard configuration doors where grain on center panels and Door 44 slab doors runs horizontally, and non-miter door rail configuration is unique from adjacent cabinet doors. Door 19 and Door 36 have a standard vertical grain pattern. Door 33 has a standard horizontal grain pattern. See page 9 for more details.
- Not available on Door 46.
- 24" deep cabinets must be fully supported by screws installed in a structural member in the ceiling or soffit, and into adjacent cabinets or tall panels.
- Load limit is 15 lbs. per square foot of load bearing surface.
- Art Glass not available.
- Cabinet may utilize one or two lift mechanisms depending on door size and weight. Door lift mechanism tension can be field adjusted.
- Depth can be reduced to a minimum of 9".
- Door will open a maximum of 107° due to hinges. For applications close to a ceiling, door angle can be restricted to 86° with a Hinge Angle Restriction Clip (HINGERESCLIP, see page 382).
- Lift mechanisms and mounting brackets will be visible if used with transparent textured glass.
- Lift mechanism not available for order for field installation, only available factory installed.

### Custom Modifications

ADDTK	AUTH	CBO	CCO	CFNTO	CFRMO	CND	EXBK	EX	FB	FFD	FPEB	ID	INVFRM	MIP	P	PFINBTMB	RD	TD	TVR_V	WLI	
	•		•		•		•	•	•		•	•		•		•	•				•

### Construction Upgrades

APC	PE
•	•

### Door Options

ALF	CG	CG.BTM	CG.TOP	DPSRR	MD	MD.BTM	MD.TOP	MFO
•†	•			•				•

†Available only on 30" and 36" wide

## WALL SINGLE DOOR, 15" HIGH

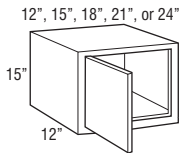

W1215 L or R

W1515 L or R

W1815 L or R

W2115 L or R

W2415 L or R

### Custom Modifications

ADDTK	AUTH	CBO	CCO	CFNTO	CFRMO	CND	EXBK	EX	FB	FFD	FPEB	ID	INVFRM	MIP	P	PFINBTMB	RD	TD	TVR_V	WLI	
•*	•		•	•	•		•	•	•		•	•		•	•	•	•				•

\*Not available on 21" and 24" wide

### Construction Upgrades

APC	PE
•	•

### Door Options

ALF	CG	CG.BTM	CG.TOP	DPSRR	MD	MD.BTM	MD.TOP	MFO
•†	•			•	•‡			•

†Not available on 12", 21", and 24" wide    ‡Not available on 12" wide

**WALL DOUBLE DOOR, 15" HIGH**

21", 24", 27", 30", 31 1/2", 33", 34", 36", or 37"

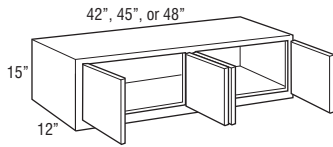
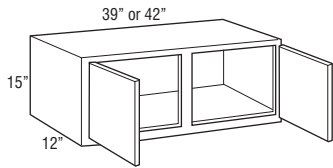
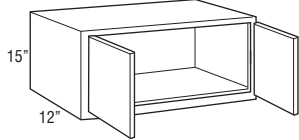

- W2115
- W2415
- W2715
- W3015
- W31.515
- W3315
- W3415
- W3615
- W3715
  
- W3915
- W4215CS

- W4215
- W4515
- W4815

• W4215CS has two doors. W4215 has four doors.

**Custom Modifications**

ADDTK	AUTH	CBO	CCO	CFNTO	CFRMO	CND	EXBK	EX	FB	FFD	FPEB	ID	INVFRM	MIP	P	PFINBTMB	RD	TD	TVR_V	WLI
•*	•		•	•	•		•	•	•		•	•		•	•	•	•			•

\*Not available on W4215CS

**Construction Upgrades**

APC	PE
•	•

**Door Options**

ALF	CG	CG.BTM	CG.TOP	DPSRR	MD	MD.BTM	MD.TOP	MFO
	•			•	• <sup>†</sup>			•

<sup>†</sup>Available only on 24", 27", 30", 33", 36", and 48" wide, and on W4215CS

**WALL TOP HINGE, 15" HIGH**

18", 21", or 24"

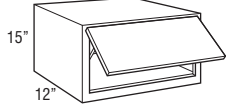

30", 33", 36", or 37"

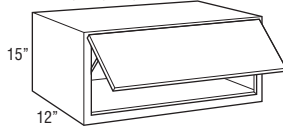

- WTH1815
- WTH2115
- WTH2415
  
- WTH3015
- WTH3315
- WTH3615
- WTH3715

- 18"-24" Wide (WTH1815-WTH2415) use standard configuration doors with vertical center panel grain. Door 19, Door 36, and Door 44 have a standard vertical grain pattern. Door 33 has a standard horizontal grain pattern. See page 9 for more details.
- 30"-37" Wide (WTH3015-WTH3715) use non-standard configuration doors where grain on center panels and Door 44 slab doors runs horizontally, and non-miter door rail configuration is unique from adjacent cabinet doors. Door 19 and Door 36 have a standard vertical grain pattern. Door 33 has a standard horizontal grain pattern. See page 9 for more details.
- Not available on Door 46.
- Art Glass not available.
- Cabinet may utilize one or two lift mechanisms depending on door size and weight. Door lift mechanism tension can be field adjusted.
- Depth can be reduced to a minimum of 9".
- Door will open a maximum of 107° due to hinges. For applications close to a ceiling, door angle can be restricted to 86° with a Hinge Angle Restriction Clip (HINGERESCLIP, see page 382).
- Lift mechanisms and mounting brackets will be visible if used with transparent textured glass.
- Lift mechanism not available for order for field installation, only available factory installed.

**Custom Modifications**

ADDTK	AUTH	CBO	CCO	CFNTO	CFRMO	CND	EXBK	EX	FB	FFD	FPEB	ID	INVFRM	MIP	P	PFINBTMB	RD	TD	TVR_V	WLI
	•		•		•		•	•	•		•	•		•		•	•			•

**Construction Upgrades**

APC	PE
•	•

**Door Options**

ALF	CG	CG.BTM	CG.TOP	DPSRR	MD	MD.BTM	MD.TOP	MFO
• <sup>†</sup>	•			•				•

<sup>†</sup>Available only on 30" and 36" wide

**WALL REFRIGERATOR SINGLE DOOR, 15" HIGH, 24" DEEP**

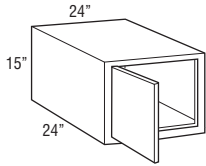

**W241524 L or R**

- 24" deep cabinets must be fully supported by screws installed in a structural member in the ceiling or soffit, and into adjacent cabinets or tall panels.
- Load limit is 15 lbs. per square foot of load bearing surface.

**Custom Modifications**

ADDTK	AUTH	CBO	CCO	CFNTO	CFRMO	CND	EXBK	EX	FB	FFD	FPEB	ID	INVFRM	MIP	P	PFINBTMB	RD	TD	TVR_V	WLI
	•		•	•		•		•	•		•	•		•		•	•			•

**Construction Upgrades**

APC	PE
•	•

**Door Options**

ALF	CG	CG.BTM	CG.TOP	DPSRR	MD	MD.BTM	MD.TOP	MFO
	•			•	•			•

**WALL REFRIGERATOR DOUBLE DOOR, 15" HIGH, 24" DEEP**

24", 27", 30", 31½", 33", 34", 36", or 37"

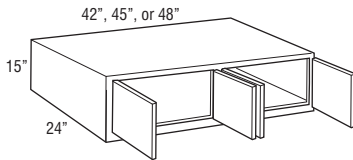
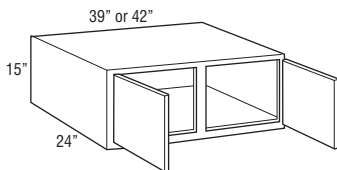
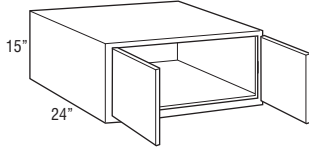

**W241524**

**W271524**

**W301524**

**W31.51524**

**W331524**

**W341524**

**W361524**

**W371524**

**W391524**

**W421524CS**

**W421524**

**W451524**

**W481524**

- 24" deep cabinets must be fully supported by screws installed in a structural member in the ceiling or soffit, and into adjacent cabinets or tall panels.
- Load limit is 15 lbs. per square foot of load bearing surface.
- W421524CS has two doors. W421524 has four doors.

**Custom Modifications**

ADDTK	AUTH	CBO	CCO	CFNTO	CFRMO	CND	EXBK	EX	FB	FFD	FPEB	ID	INVFRM	MIP	P	PFINBTMB	RD	TD	TVR_V	WLI
•*	•		•	•	•		•	•	•		•	•		•		•	•			•

\*Not available on W421524CS

**Construction Upgrades**

APC	PE
•	•

**Door Options**

ALF	CG	CG.BTM	CG.TOP	DPSRR	MD	MD.BTM	MD.TOP	MFO
	•			•	•†			•

†Available only on 24", 27", 30", 33", 36", and 48" wide, and on W421524CS

**WALL TOP HINGE REFRIGERATOR,  
15" HIGH, 24" DEEP**

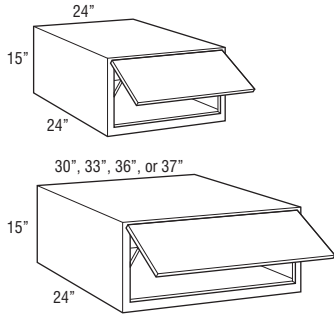

**WTH241524**

**WTH301524**

**WTH331524**

**WTH361524**

**WTH371524**

- 24" Wide (WTH241524) uses standard configuration doors with vertical center panel grain. Door 19, Door 36, and Door 44 have a standard vertical grain pattern. Door 33 has a standard horizontal grain pattern. See page 9 for more details.
- 30"-37" Wide (WTH301524-WTH371524) use non-standard configuration doors where grain on center panels and Door 44 slab doors runs horizontally, and non-miter door rail configuration is unique from adjacent cabinet doors. Door 19 and Door 36 have a standard vertical grain pattern. Door 33 has a standard horizontal grain pattern. See page 9 for more details.
- Not available on Door 46.
- 24" deep cabinets must be fully supported by screws installed in a structural member in the ceiling or soffit, and into adjacent cabinets or tall panels.
- Load limit is 15 lbs. per square foot of load bearing surface.
- Art Glass not available.
- Cabinet may utilize one or two lift mechanisms depending on door size and weight. Door lift mechanism tension can be field adjusted.
- Depth can be reduced to a minimum of 9".
- Door will open a maximum of 107° due to hinges. For applications close to a ceiling, door angle can be restricted to 86° with a Hinge Angle Restriction Clip (HINGERESCLIP, see page 382).
- Lift mechanisms and mounting brackets will be visible if used with transparent textured glass.
- Lift mechanism not available for order for field installation, only available factory installed.

**Custom Modifications**

ADDTK	AUTH	CBO	CCO	CFNTO	CFRMO	CND	EXBK	EX	FB	FFD	FPEB	ID	INVFRM	MIP	P	PFINBTMB	RD	TD	TVR_V	WLI	
	•		•			•		•	•			•	•			•		•			•

**Construction Upgrades**

APC	PE
•	•

**Door Options**

ALF	CG	CG.BTM	CG.TOP	DPSRR	MD	MD.BTM	MD.TOP	MFO
•†	•			•				•

†Available only on 30" and 36" wide

**WALL SINGLE DOOR, 18" HIGH**

12", 15", 18", 21", or 24"

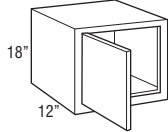

**W1218 L or R**

**W1518 L or R**

**W1818 L or R**

**W2118 L or R**

**W2418 L or R**

**Custom Modifications**

ADDTK	AUTH	CBO	CCO	CFNTO	CFRMO	CND	EXBK	EX	FB	FFD	FPEB	ID	INVFRM	MIP	P	PFINBTMB	RD	TD	TVR_V	WLI	
•	•		•	•		•		•	•	•	•	•	•	•	•	•	•	•	•	•	•

**Construction Upgrades**

APC	PE
•	•

**Door Options**

ALF	CG	CG.BTM	CG.TOP	DPSRR	MD	MD.BTM	MD.TOP	MFO
	•			•	•†			•

†Not available on 12" wide

**WALL DOUBLE DOOR, 18" HIGH**

24", 27", 30", 31 1/2", 33", 34", 36", or 37"

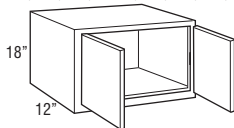

39", 42", 45", or 48"

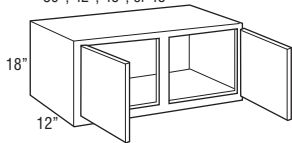

48"

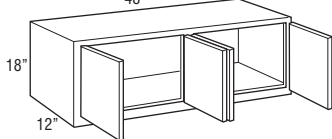

- W2418
- W2718
- W3018
- W31.518
- W3318
- W3418
- W3618
- W3718
  
- W3918
- W4218
- W4518
- W4818CS

**W4818**

**Custom Modifications**

ADDTK	AUTH	CBO	CCO	CFNTO	CFRMO	CND	EXBK	EX	FB	FFD	FPEB	ID	INVFRM	MIP	P	PFINBTMB	RD	TD	TVR_V	WLI	
•	•		•	•	•		•	•	•	•	•	•		•	•		•	•	•*		•

\*Not available on 39", 42", 45", and 48" wide

**Construction Upgrades**

APC	PE
•	•

**Door Options**

ALF	CG	CG.BTM	CG.TOP	DPSRR	MD	MD.BTM	MD.TOP	MFO
	•			•	•†			•

†Available only on 24", 27", 30", 33", 36", 42", 45", and 48" wide

**WALL TOP HINGE, 18" HIGH**

18", 21", or 24"

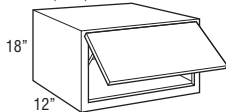

30", 33", 36", or 37"

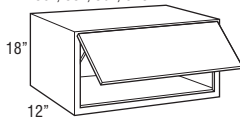

- WTH1818
- WTH2118
- WTH2418
  
- WTH3018
- WTH3318
- WTH3618
- WTH3718

- 18"-24" Wide (WTH1818-WTH2418) use standard configuration doors with vertical center panel grain. Door 19, Door 36, and Door 44 have a standard vertical grain pattern. Door 33 has a standard horizontal grain pattern. See page 9 for more details.
- 30"-37" Wide (WTH3018-WTH3718) use non-standard configuration doors where grain on center panels and Door 44 slab doors runs horizontally, and non-miter door rail configuration is unique from adjacent cabinet doors. Door 19 and Door 36 have a standard vertical grain pattern. Door 33 has a standard horizontal grain pattern. See page 9 for more details.
- Not available on Door 46.
- Art Glass not available.
- Cabinet may utilize one or two lift mechanisms depending on door size and weight. Door lift mechanism tension can be field adjusted.
- Depth can be reduced to a minimum of 9".
- Door will open a maximum of 107° due to hinges. For applications close to a ceiling, door angle can be restricted to 86° with a Hinge Angle Restriction Clip (HINGERESCLIP, see page 382).
- Lift mechanisms and mounting brackets will be visible if used with transparent textured glass.
- Lift mechanism not available for order for field installation, only available factory installed.

**Custom Modifications**

ADDTK	AUTH	CBO	CCO	CFNTO	CFRMO	CND	EXBK	EX	FB	FFD	FPEB	ID	INVFRM	MIP	P	PFINBTMB	RD	TD	TVR_V	WLI
	•		•		•		•	•	•		•	•		•		•	•	•		•

**Construction Upgrades**

APC	PE
•	•

**Door Options**

ALF	CG	CG.BTM	CG.TOP	DPSRR	MD	MD.BTM	MD.TOP	MFO
•†	•			•				•

†Available only on 30" and 36" wide

**WALL VERTICAL-LIFT, 18" HIGH, 12" DEEP**

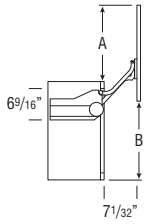
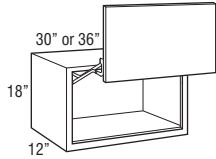

	Full Overlay	Modified Full Overlay
A	16 13/16"	16 1/16"
B	17 5/16"	17 5/16"

**WVL3018  
WVL3618**

- Uses non-standard configuration doors where grain on center panels and Door 44 slab doors runs horizontally, and non-miter door rail configuration is unique from adjacent cabinet doors. Door 19 and Door 36 have a standard vertical grain pattern. Door 33 has a standard horizontal grain pattern. See page 9 for more details.
- Decorative hardware required.
- See side view drawing for required clearances.
- Lift mechanism features a single motion for up and out movement with smart close, tension can be field adjusted.
- Lift mechanisms and mounting brackets will be visible if used with transparent textured glass.
- Lift mechanism not available for order for field installation, only available factory installed.
- Hardware extends 1" into opening on each side.
- Art Glass not available.
- Not available on Door 46.

**Custom Modifications**

ADDTK	AUTH	CBO	CCO	CFNTO	CFRMO	CND	EXBK	EX	FB	FFD	FPEB	ID	INVFRM	MIP	P	PFINBTMB	RD	TD	TVR_V	WLI
	•		•		•		•	•	•		•	•		•		•				•

**Construction Upgrades**

APC	PE
•	•

**Door Options**

ALF	CG	CG.BTM	CG.TOP	DPSRR	MD	MD.BTM	MD.TOP	MFO
•	•			•				•

**WALL REFRIGERATOR SINGLE or DOUBLE DOOR, 18" HIGH, 24" DEEP**

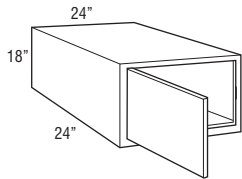

24", 27", 30", 31 1/2", 33", 34", 36", or 37"

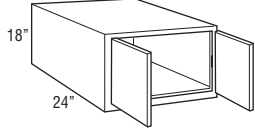

39", 42", 45", or 48"

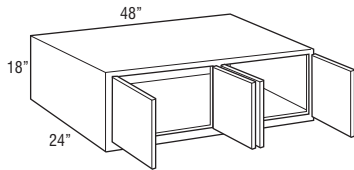
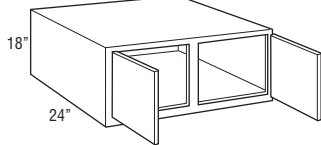

**W241824 L or R**

- W241824**
- W271824**
- W301824**
- W31.51824**
- W331824**
- W341824**
- W361824**
- W371824**
- W391824**
- W421824**
- W451824**
- W481824CS**

**W481824**

- 24" deep cabinets must be fully supported by screws installed in a structural member in the ceiling or soffit, and into adjacent cabinets or tall panels.
- Load limit is 15 lbs. per square foot of load bearing surface.

**Custom Modifications**

ADDTK	AUTH	CBO	CCO	CFNTO	CFRMO	CND	EXBK	EX	FB	FFD	FPEB	ID	INVFRM	MIP	P	PFINBTMB	RD	TD	TVR_V	WLI
•	•		•	•	•		•	•	•	•	•	•		•		•			•*	•

\*Not available on 39", 42", 45", and 48" wide

**Construction Upgrades**

APC	PE
•	•

**Door Options**

ALF	CG	CG.BTM	CG.TOP	DPSRR	MD	MD.BTM	MD.TOP	MFO
	•			•	†			•

†Available only on 24", 27", 30", 33", 36", 42", 45", and 48" wide

**WALL TOP HINGE REFRIGERATOR,  
18" HIGH, 24" DEEP**

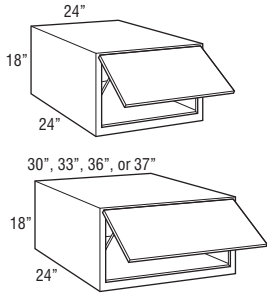

**WTH241824**

**WTH301824**

**WTH331824**

**WTH361824**

**WTH371824**

- 24" Wide (WTH241824) uses standard configuration doors with vertical center panel grain. Door 19, Door 36, and Door 44 have a standard vertical grain pattern. Door 33 has a standard horizontal grain pattern. See page 9 for more details.
- 30"-37" Wide (WTH301824-WTH371824) use non-standard configuration doors where grain on center panels and Door 44 slab doors runs horizontally, and non-miter door rail configuration is unique from adjacent cabinet doors. Door 19 and Door 36 have a standard vertical grain pattern. Door 33 has a standard horizontal grain pattern. See page 9 for more details.
- Not available on Door 46.
- 24" deep cabinets must be fully supported by screws installed in a structural member in the ceiling or soffit, and into adjacent cabinets or tall panels.
- Load limit is 15 lbs. per square foot of load bearing surface.
- Art Glass not available.
- Cabinet may utilize one or two lift mechanisms depending on door size and weight. Door lift mechanism tension can be field adjusted.
- Depth can be reduced to a minimum of 9".
- Door will open a maximum of 107° due to hinges. For applications close to a ceiling, door angle can be restricted to 86° with a Hinge Angle Restriction Clip (HINGERESCLIP, see page 382).
- Lift mechanisms and mounting brackets will be visible if used with transparent textured glass.
- Lift mechanism not available for order for field installation, only available factory installed.

**Custom Modifications**

ADDTK	AUTH	CBO	CCO	CFNTO	CFRMO	CND	EXBK	EX	FB	FFD	FPEB	ID	INVFRM	MIP	P	PFINBTMB	RD	TD	TVR_V	WLI
	•		•		•		•	•	•		•	•		•		•	•	•		•

**Construction Upgrades**

APC	PE
•	•

**Door Options**

ALF	CG	CG.BTM	CG.TOP	DPSRR	MD	MD.BTM	MD.TOP	MFO
•†	•			•				•

†Available only on 30" and 36" wide

**WALL REFRIGERATOR  
VERTICAL-LIFT, 18" HIGH, 24" DEEP**

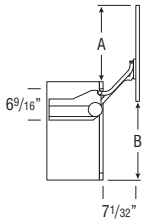
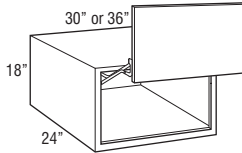

	Full Overlay	Modified Full Overlay
A	16 13/16"	16 1/16"
B	17 5/16"	17 5/16"

**WVL301824**

**WVL361824**

- Uses non-standard configuration doors where grain on center panels and Door 44 slab doors runs horizontally, and non-miter door rail configuration is unique from adjacent cabinet doors. Door 19 and Door 36 have a standard vertical grain pattern. Door 33 has a standard horizontal grain pattern. See page 9 for more details.
- 24" deep cabinets must be fully supported by screws installed in a structural member in the ceiling or soffit, and into adjacent cabinets or tall panels.
- Decorative hardware required.
- See side view drawing for required clearances.
- Lift mechanism features a single motion for up and out movement with smart close, tension can be field adjusted.
- Lift mechanisms and mounting brackets will be visible if used with transparent textured glass.
- Lift mechanism not available for order for field installation, only available factory installed.
- Hardware extends 1" into opening on each side.
- Art Glass not available.
- Not available on Door 46.
- Depth can be reduced to a minimum of 12".

**Custom Modifications**

ADDTK	AUTH	CBO	CCO	CFNTO	CFRMO	CND	EXBK	EX	FB	FFD	FPEB	ID	INVFRM	MIP	P	PFINBTMB	RD	TD	TVR_V	WLI
	•		•		•		•	•	•		•	•		•		•	•	•		•

**Construction Upgrades**

APC	PE
•	•

**Door Options**

ALF	CG	CG.BTM	CG.TOP	DPSRR	MD	MD.BTM	MD.TOP	MFO
•	•			•				•

**WALL REFRIGERATOR PULL-OUT, 18" HIGH, 24" DEEP**

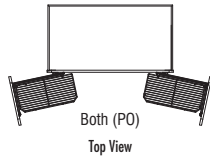
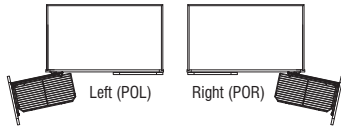
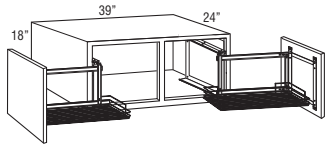
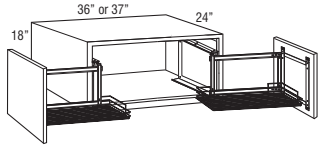

- W361824PO L or R**
- W371824PO L or R**
- W361824PO**
- W371824PO**

**W391824PO L or R**  
**W391824PO**

- Door-mounted pull-out with a chrome wire rack that extends fully to the front of the cabinet then opens to the side for easy accessibility to contents. Designed for use above refrigerators or other high applications. Smart close not included.
- Available installed in either the left side, right side, or both sides.
- For sufficient pull-out clearance, 13 1/8" of adjacent space is required for door to open fully when installed near a wall or corner.
- Chrome rack is 10" wide and 20 13/16" deep.
- 24" deep cabinets must be fully supported by screws installed in a structural member in the ceiling or soffit, and into adjacent cabinets or tall panels.
- Load limit is 20 lbs. per pull-out.

**Custom Modifications**

ADDTK	AUTH	CBO	CCO	CFNTO	CFRMO	CND	EXBK	EX	FB	FFD	FPEB	ID	INVFRM	MIP	P	PFINBTMB	RD	TD	TVR_V	WLI
•	•	•				•	•	•	•		•			•		•				•

**Construction Upgrades**

APC	PE
•	•

**Door Options**

ALF	CG	CG.BTM	CG.TOP	DPSRR	MD	MD.BTM	MD.TOP	MFO
				•				•

**WALL SINGLE DOOR, 21" HIGH**

12", 15", 18", 21", or 24"

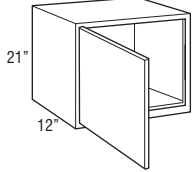

- W1221 L or R**
- W1521 L or R**
- W1821 L or R**
- W2121 L or R**
- W2421 L or R**

**Custom Modifications**

ADDTK	AUTH	CBO	CCO	CFNTO	CFRMO	CND	EXBK	EX	FB	FFD	FPEB	ID	INVFRM	MIP	P	PFINBTMB	RD	TD	TVR_V	WLI
•	•		•	•		•	•	•	•	•	•	•		•	•	•	•	•		•

**Construction Upgrades**

APC	PE
•	•

**Door Options**

ALF	CG	CG.BTM	CG.TOP	DPSRR	MD	MD.BTM	MD.TOP	MFO
	•			•				•



**WALL DOUBLE DOOR, 21" HIGH**

24", 27", 30", 31 1/2", 33", 34", 36", or 37"

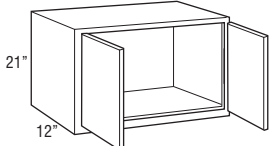

39", 42", 45", or 48"

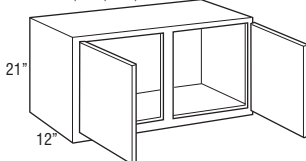

48"

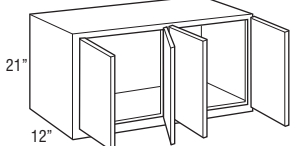

**W2421**

**W2721**

**W3021**

**W31.521**

**W3321**

**W3421**

**W3621**

**W3721**

**W3921**

**W4221**

**W4521**

**W4821CS**

**W4821**

**Custom Modifications**

ADDTK	AUTH	CBO	CCO	CFNTO	CFRMO	CND	EXBK	EX	FB	FFD	FPEB	ID	INVFRM	MIP	P	PFINBTMB	RD	TD	TVR_V	WLI	
•	•		•	•	•		•	•	•	•	•	•		•	•		•	•	•*		•

\*Not available on 39", 42", 45", and 48" wide

**Construction Upgrades**

APC	PE
•	•

**Door Options**

ALF	CG	CG.BTM	CG.TOP	DPSRR	MD	MD.BTM	MD.TOP	MFO
	•			•				•

**WALL TOP HINGE, 21" HIGH**

18", 21", or 24"

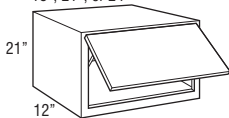

30", 33", 36", or 37"

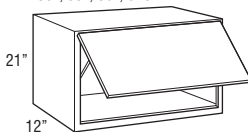

**WTH1821**

**WTH2121**

**WTH2421**

**WTH3021**

**WTH3321**

**WTH3621**

**WTH3721**

- 18"-24" Wide (WTH1821-WTH2421) use standard configuration doors with vertical center panel grain. Door 19, Door 36, and Door 44 have a standard vertical grain pattern. Door 33 has a standard horizontal grain pattern. See page 9 for more details.
- 30"-37" Wide (WTH3021-WTH3721) use non-standard configuration doors where grain on center panels and Door 44 slab doors runs horizontally, and non-miter door rail configuration is unique from adjacent cabinet doors. Door 19 and Door 36 have a standard vertical grain pattern. Door 33 has a standard horizontal grain pattern. See page 9 for more details.
- Not available on Door 46.
- Art Glass not available.
- Cabinet may utilize one or two lift mechanisms depending on door size and weight. Door lift mechanism tension can be field adjusted.
- Depth can be reduced to a minimum of 9".
- Door will open a maximum of 107° due to hinges. For applications close to a ceiling, door angle can be restricted to 86° with a Hinge Angle Restriction Clip (HINGERESCLIP, see page 382).
- Lift mechanisms and mounting brackets will be visible if used with transparent textured glass.
- Lift mechanism not available for order for field installation, only available factory installed.

**Custom Modifications**

ADDTK	AUTH	CBO	CCO	CFNTO	CFRMO	CND	EXBK	EX	FB	FFD	FPEB	ID	INVFRM	MIP	P	PFINBTMB	RD	TD	TVR_V	WLI
	•		•		•		•	•	•		•	•		•		•	•	•		•

**Construction Upgrades**

APC	PE
•	•

**Door Options**

ALF	CG	CG.BTM	CG.TOP	DPSRR	MD	MD.BTM	MD.TOP	MFO
•†	•			•				•

†Available only on 30" and 36" wide

**WALL VERTICAL-LIFT, 21" HIGH, 12" DEEP**

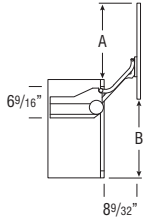
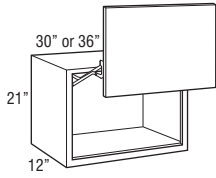

	Full Overlay	Modified Full Overlay
A	20"	19 1/4"
B	20 1/2"	20 1/2"

**WVL3021  
WVL3621**

- Uses non-standard configuration doors where grain on center panels and Door 44 slab doors runs horizontally, and non-miter door rail configuration is unique from adjacent cabinet doors. Door 19 and Door 36 have a standard vertical grain pattern. Door 33 has a standard horizontal grain pattern. See page 9 for more details.
- Decorative hardware required.
- See side view drawing for required clearances.
- Lift mechanism features a single motion for up and out movement with smart close, tension can be field adjusted.
- Lift mechanisms and mounting brackets will be visible if used with transparent textured glass.
- Lift mechanism not available for order for field installation, only available factory installed.
- Hardware extends 1" into opening on each side.
- Art Glass not available.
- Not available on Door 46.

**Custom Modifications**

ADDTK	AUTH	CBO	CCO	CFNTO	CFRMO	CND	EXBK	EX	FB	FFD	FPEB	ID	INVFRM	MIP	P	PFINBTMB	RD	TD	TVR_V	WLI
	•		•		•		•	•	•		•	•		•		•				•

**Construction Upgrades**

APC	PE
•	•

**Door Options**

ALF	CG	CG.BTM	CG.TOP	DPSRR	MD	MD.BTM	MD.TOP	MFO
•	•			•				•

**WALL REFRIGERATOR SINGLE or DOUBLE DOOR, 21" HIGH, 24" DEEP**

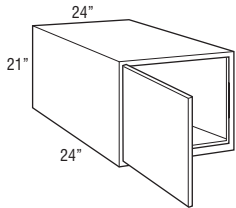

24", 27", 30", 31 1/2", 33", 34", 36", or 37"

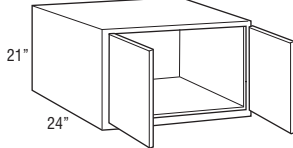

39", 42", 45", or 48"

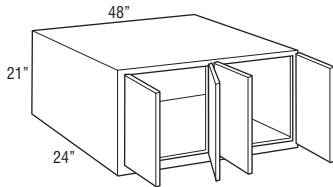
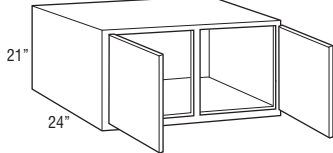

**W242124 L or R**

- W242124  
W272124  
W302124  
W31.52124  
W332124  
W342124  
W362124  
W372124  
  
W392124  
W422124  
W452124  
W482124CS**

**W482124**

- 24" deep cabinets must be fully supported by screws installed in a structural member in the ceiling or soffit, and into adjacent cabinets or tall panels.
- Load limit is 15 lbs. per square foot of load bearing surface.

**Custom Modifications**

ADDTK	AUTH	CBO	CCO	CFNTO	CFRMO	CND	EXBK	EX	FB	FFD	FPEB	ID	INVFRM	MIP	P	PFINBTMB	RD	TD	TVR_V	WLI	
•	•		•	•	•		•	•	•	•	•	•		•		•		•	•*		•

\*Not available on 39", 42", 45", and 48" wide

**Construction Upgrades**

APC	PE
•	•

**Door Options**

ALF	CG	CG.BTM	CG.TOP	DPSRR	MD	MD.BTM	MD.TOP	MFO
•	•			•				•

## WALL TOP HINGE REFRIGERATOR, 21" HIGH, 24" DEEP

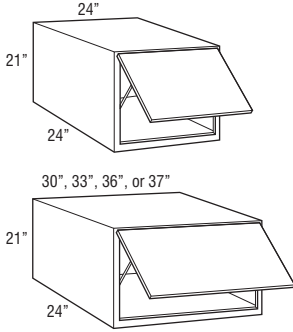

WTH242124

WTH302124

WTH332124

WTH362124

WTH372124

- 24" Wide (WTH242124) uses standard configuration doors with vertical center panel grain. Door 19, Door 36, and Door 44 have a standard vertical grain pattern. Door 33 has a standard horizontal grain pattern. See page 9 for more details.
- 30"-37" Wide (WTH302124-WTH372124) use non-standard configuration doors where grain on center panels and Door 44 slab doors runs horizontally, and non-miter door rail configuration is unique from adjacent cabinet doors. Door 19 and Door 36 have a standard vertical grain pattern. Door 33 has a standard horizontal grain pattern. See page 9 for more details.
- Not available on Door 46.
- 24" deep cabinets must be fully supported by screws installed in a structural member in the ceiling or soffit, and into adjacent cabinets or tall panels.
- Load limit is 15 lbs. per square foot of load bearing surface.
- Art Glass not available.
- Cabinet may utilize one or two lift mechanisms depending on door size and weight. Door lift mechanism tension can be field adjusted.
- Depth can be reduced to a minimum of 9".
- Door will open a maximum of 107° due to hinges. For applications close to a ceiling, door angle can be restricted to 86° with a Hinge Angle Restriction Clip (HINGERESCLIP, see page 382).
- Lift mechanisms and mounting brackets will be visible if used with transparent textured glass.
- Lift mechanism not available for order for field installation, only available factory installed.

### Custom Modifications

ADDTK	AUTH	CBO	CCO	CFNTO	CFRMO	CND	EXBK	EX	FB	FFD	FPEB	ID	INVFRM	MIP	P	PFINBTMB	RD	TD	TVR_V	WLI
	•		•			•		•	•		•	•		•			•	•		•

### Construction Upgrades

APC	PE
•	•

### Door Options

ALF	CG	CG.BTM	CG.TOP	DPSRR	MD	MD.BTM	MD.TOP	MFO
•†	•			•				•

†Available only on 30" and 36" wide

## WALL REFRIGERATOR VERTICAL-LIFT, 21" HIGH, 24" DEEP

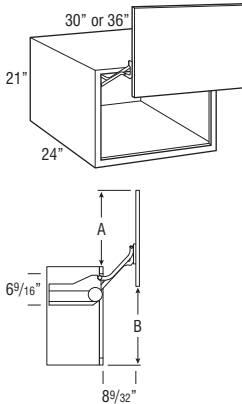

WVL302124

WVL362124

- Uses non-standard configuration doors where grain on center panels and Door 44 slab doors runs horizontally, and non-miter door rail configuration is unique from adjacent cabinet doors. Door 19 and Door 36 have a standard vertical grain pattern. Door 33 has a standard horizontal grain pattern. See page 9 for more details.
- 24" deep cabinets must be fully supported by screws installed in a structural member in the ceiling or soffit, and into adjacent cabinets or tall panels.
- Decorative hardware required.
- See side view drawing for required clearances.
- Lift mechanism features a single motion for up and out movement with smart close, tension can be field adjusted.
- Lift mechanisms and mounting brackets will be visible if used with transparent textured glass.
- Lift mechanism not available for order for field installation, only available factory installed.
- Hardware extends 1" into opening on each side.
- Art Glass not available.
- Not available on Door 46.
- Depth can be reduced to a minimum of 12".

### Custom Modifications

ADDTK	AUTH	CBO	CCO	CFNTO	CFRMO	CND	EXBK	EX	FB	FFD	FPEB	ID	INVFRM	MIP	P	PFINBTMB	RD	TD	TVR_V	WLI
	•		•			•		•	•		•	•		•			•	•		•

### Construction Upgrades

APC	PE
•	•

### Door Options

ALF	CG	CG.BTM	CG.TOP	DPSRR	MD	MD.BTM	MD.TOP	MFO
•	•			•				•

	Full Overlay	Modified Full Overlay
A	20"	19 1/4"
B	20 1/2"	20 1/2"

**WALL REFRIGERATOR PULL-OUT,  
21" HIGH, 24" DEEP**

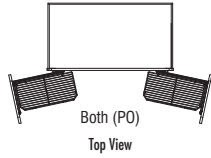
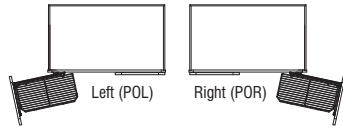
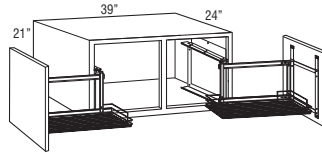
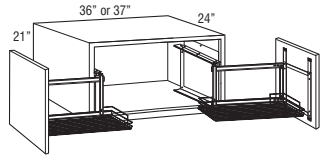

**W362124PO L or R**  
**W372124PO L or R**  
**W362124PO**  
**W372124PO**

**W392124PO L or R**  
**W392124PO**

- Door-mounted pull-out with a chrome wire rack that extends fully to the front of the cabinet then opens to the side for easy accessibility to contents. Designed for use above refrigerators or other high applications. Smart close not included.
- Available installed in either the left side, right side, or both sides.
- For sufficient pull-out clearance, 13 1/8" of adjacent space is required for door to open fully when installed near a wall or corner.
- Chrome rack is 10" wide and 20 13/16" deep.
- 24" deep cabinets must be fully supported by screws installed in a structural member in the ceiling or soffit, and into adjacent cabinets or tall panels.
- Load limit is 20 lbs. per pull-out.

**Custom Modifications**

ADDTK	AUTH	CBO	CCO	CFNTO	CFRMO	CND	EXBK	EX	FB	FFD	FPEB	ID	INVFRM	MIP	P	PFINBTMB	RD	TD	TVR_V	WLI
•	•		•			•		•	•		•			•		•				•

**Construction Upgrades**

APC	PE
•	•

**Door Options**

ALF	CG	CG.BTM	CG.TOP	DPSRR	MD	MD.BTM	MD.TOP	MFO
				•				•

**WALL SINGLE DOOR, 24" HIGH**

12", 15", 18", 21", or 24"

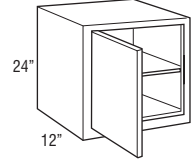

**W1224 L or R**  
**W1524 L or R**  
**W1824 L or R**  
**W2124 L or R**  
**W2424 L or R**

**Custom Modifications**

ADDTK	AUTH	CBO	CCO	CFNTO	CFRMO	CND	EXBK	EX	FB	FFD	FPEB	ID	INVFRM	MIP	P	PFINBTMB	RD	TD	TVR_V	WLI
•	•	•	•	•	•		•	•	•	•	•	•	•	•	•	•	•	•	•	•

**Construction Upgrades**

APC	PE
•	•

**Door Options**

ALF	CG	CG.BTM	CG.TOP	DPSRR	MD	MD.BTM	MD.TOP	MFO
	•			•	• <sup>†</sup>			•

<sup>†</sup>Not available on 12" wide

**WALL DOUBLE DOOR, 24" HIGH**

24", 27", 30", 31½", 33", 34", 36", or 37"

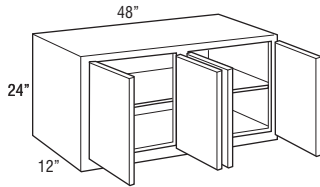
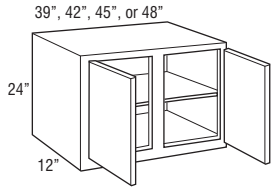
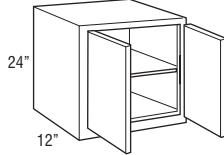

- W2424
- W2724
- W3024
- W31.524
- W3324
- W3424
- W3624
- W3724

- W3924
- W4224
- W4524
- W4824CS

**W4824**

**Custom Modifications**

ADDTK	AUTH	CBO	CCO	CFNTO	CFRMO	CND	EXBK	EX	FB	FFD	FPEB	ID	INVFRM	MIP	P	PFINBTMB	RD	TD	TVR_V	WLI	
•	•	•	•	•	•		•	•	•	•	•	•		•	•		•	•	•*		•

\*Not available on 39", 42", 45", and 48" wide

**Construction Upgrades**

APC	PE
•	•

**Door Options**

ALF	CG	CG.BTM	CG.TOP	DPSRR	MD	MD.BTM	MD.TOP	MFO
	•			•	•†			•

†Available only on 24", 27", 30", 33", 36", 42", 45", and 48" wide

**WALL REFRIGERATOR SINGLE or DOUBLE DOOR, 24" HIGH, 24" DEEP**

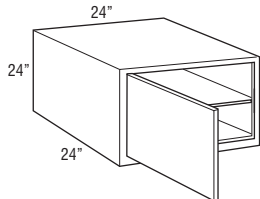

24", 27", 30", 31½", 33", 34", 36", or 37"

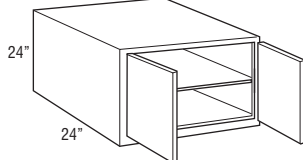

39", 42", 45", or 48"

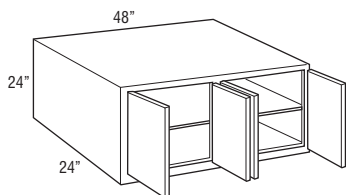
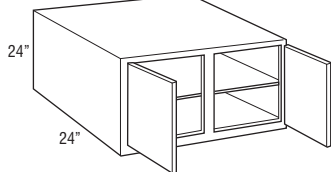

**W242424 L or R**

- W242424
- W272424
- W302424
- W31.52424
- W332424
- W342424
- W362424
- W372424

- W392424
- W422424
- W452424
- W482424CS

**W482424**

- 24" deep cabinets must be fully supported by screws installed in a structural member in the ceiling or soffit, and into adjacent cabinets or tall panels.
- Load limit is 15 lbs. per square foot of load bearing surface.
- Shelf is 21" deep on W392424, W422424, W452424, W482424CS, and W482424 to allow for the shelf to be removed from the cabinet.

**Custom Modifications**

ADDTK	AUTH	CBO	CCO	CFNTO	CFRMO	CND	EXBK	EX	FB	FFD	FPEB	ID	INVFRM	MIP	P	PFINBTMB	RD	TD	TVR_V	WLI	
•	•	•	•	•	•		•	•	•	•	•	•		•	•		•	•	•*		•

\*Not available on 39", 42", 45", and 48" wide

**Construction Upgrades**

APC	PE
•	•

**Door Options**

ALF	CG	CG.BTM	CG.TOP	DPSRR	MD	MD.BTM	MD.TOP	MFO
	•			•	•†			•

†Available only on 24", 27", 30", 33", 36", 42", 45", and 48" wide

**WALL REFRIGERATOR PULL-OUT,  
24" HIGH, 24" DEEP**

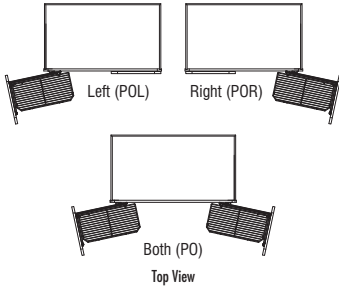
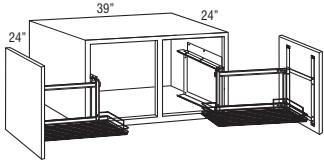
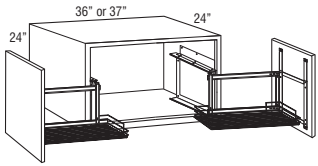

**W362424PO L or R**  
**W372424PO L or R**  
**W362424PO**  
**W372424PO**

**W392424PO L or R**  
**W392424PO**

- Door-mounted pull-out with a chrome wire rack that extends fully to the front of the cabinet then opens to the side for easy accessibility to contents. Designed for use above refrigerators or other high applications. Smart close not included.
- Available installed in either the left side, right side, or both sides.
- For sufficient pull-out clearance, 13 1/8" of adjacent space is required for door to open fully when installed near a wall or corner.
- Chrome rack is 10" wide and 20 13/16" deep.
- 24" deep cabinets must be fully supported by screws installed in a structural member in the ceiling or soffit, and into adjacent cabinets or tall panels.
- Load limit is 20 lbs. per pull-out.

**Custom Modifications**

ADDTK	AUTH	CBO	CCO	CFNTO	CFRMO	CND	EXBK	EX	FB	FFD	FPEB	ID	INVFRM	MIP	P	PFINBTMB	RD	TD	TVR_V	WLI	
•	•		•			•		•	•		•			•							•

**Construction Upgrades**

APC	PE
•	•

**Door Options**

ALF	CG	CG.BTM	CG.TOP	DPSRR	MD	MD.BTM	MD.TOP	MFO
				•				•

**WALL SINGLE DOOR, 27" HIGH**

12", 15", 18", 21", or 24"

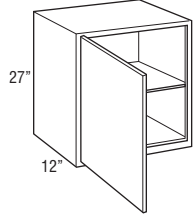

**W1227 L or R**  
**W1527 L or R**  
**W1827 L or R**  
**W2127 L or R**  
**W2427 L or R**

**Custom Modifications**

ADDTK	AUTH	CBO	CCO	CFNTO	CFRMO	CND	EXBK	EX	FB	FFD	FPEB	ID	INVFRM	MIP	P	PFINBTMB	RD	TD	TVR_V	WLI	
•	•	•	•	•	•		•	•	•	•	•	•		•	•	•	•	•			•

**Construction Upgrades**

APC	PE
•	•

**Door Options**

ALF	CG	CG.BTM	CG.TOP	DPSRR	MD	MD.BTM	MD.TOP	MFO
	•			•				•

**WALL DOUBLE DOOR, 27" HIGH**

24", 27", 30", 33", 34", 36", or 37"

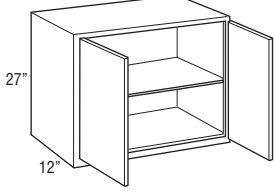

39", 42", 45", or 48"

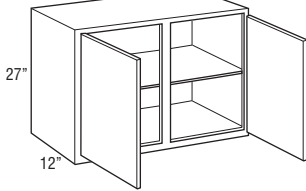

48"

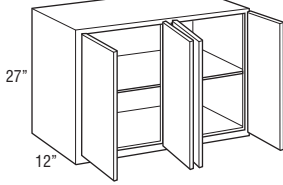

- W2427
- W2727
- W3027
- W3327
- W3427
- W3627
- W3727

- W3927
- W4227
- W4527
- W4827CS

**W4827**

**Custom Modifications**

ADDTK	AUTH	CBO	CCO	CFNTD	CFRMO	CND	EXBK	EX	FB	FFD	FPEB	ID	INVRM	MIP	P	PFINBTMB	RD	TD	TVR_V	WLI
•	•	•	•	•	•		•	•	•	•	•	•		•	•	•	•	•*		•

\*Not available on 39", 42", 45", and 48" wide

**Construction Upgrades**

APC	PE
•	•

**Door Options**

ALF	CG	CG.BTM	CG.TOP	DPSRR	MD	MD.BTM	MD.TOP	MFO
•				•				•

**WALL REFRIGERATOR SINGLE or DOUBLE DOOR, 27" HIGH, 24" DEEP**

**W242724 L or R**

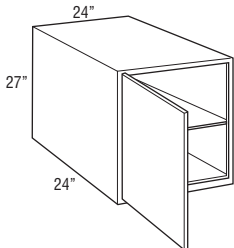

24", 27", 30", 33", 34", 36", or 37"

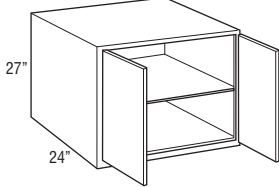

39", 42", 45", or 48"

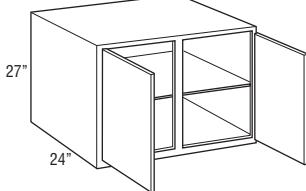

48"

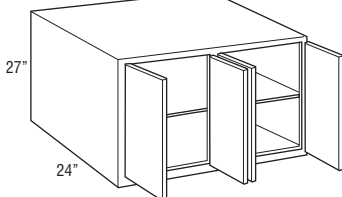

- W242724
- W272724
- W302724
- W332724
- W342724
- W362724
- W372724

- W392724
- W422724
- W452724
- W482724CS

**W482724**

- 24" deep cabinets must be fully supported by screws installed in a structural member in the ceiling or soffit, and into adjacent cabinets or tall panels.
- Load limit is 15 lbs. per square foot of load bearing surface.

**Custom Modifications**

ADDTK	AUTH	CBO	CCO	CFNTD	CFRMO	CND	EXBK	EX	FB	FFD	FPEB	ID	INVRM	MIP	P	PFINBTMB	RD	TD	TVR_V	WLI
•	•	•	•	•	•		•	•	•	•	•	•		•	•	•	•	•*		•

\*Not available on 39", 42", 45", and 48" wide

**Construction Upgrades**

APC	PE
•	•

**Door Options**

ALF	CG	CG.BTM	CG.TOP	DPSRR	MD	MD.BTM	MD.TOP	MFO
•				•				•

**WALL SINGLE DOOR, 30" HIGH**

9", 12", 15", 18", 21", or 24"

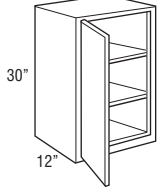

- W930 L or R
- W1230 L or R
- W1530 L or R
- W1830 L or R
- W2130 L or R
- W2430 L or R

**Custom Modifications**

ADDTK	AUTH	CBO	CCO	CFNTO	CFRMO	CND	EXBK	EX	FB	FFD	FPEB	ID	INVFRM	MIP	P	PFINBTMB	RD	TD	TVR_V	WLI	
•	•	•	•	•	•	•	•	•	•	•	•	•	•	•	•	•	•	•	•	•	•

**Construction Upgrades**

APC	PE
•	•

**Door Options**

ALF	CG	CG.BTM	CG.TOP	DPSRR	MD	MD.BTM	MD.TOP	MFO
• <sup>†</sup>	•			•	• <sup>‡</sup>			•

<sup>†</sup>Not available on 9" and 24" wide  
<sup>‡</sup>Not available on 9" and 12" wide

**WALL DOUBLE DOOR, 30" HIGH**

24", 27", 30", 33", or 36"

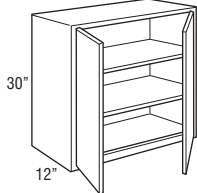

39", 42", 45", or 48"

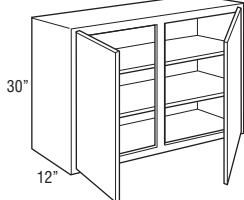

48"

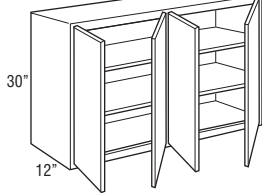

- W2430
- W2730
- W3030
- W3330
- W3630
  
- W3930
- W4230
- W4530
- W4830CS

**W4830**

**Custom Modifications**

ADDTK	AUTH	CBO	CCO	CFNTO	CFRMO	CND	EXBK	EX	FB	FFD	FPEB	ID	INVFRM	MIP	P	PFINBTMB	RD	TD	TVR_V	WLI	
•	•	•	•	•	•	•	•	•	•	•	•	•	•	•	•	•	•	•	•*	•	•

\*Not available on 39", 42", 45", and 48" wide

**Construction Upgrades**

APC	PE
•	•

**Door Options**

ALF	CG	CG.BTM	CG.TOP	DPSRR	MD	MD.BTM	MD.TOP	MFO
	•			•	• <sup>†</sup>			•

<sup>†</sup>Not available on 39" wide

**WALL SINGLE DOOR, 33" HIGH**

9", 12", 15", 18", 21", or 24"

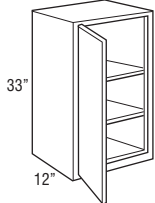

- W933 L or R
- W1233 L or R
- W1533 L or R
- W1833 L or R
- W2133 L or R
- W2433 L or R

**Custom Modifications**

ADDTK	AUTH	CBO	CCO	CFNTO	CFRMO	CND	EXBK	EX	FB	FFD	FPEB	ID	INVFRM	MIP	P	PFINBTMB	RD	TD	TVR_V	WLI	
•	•	•	•	•	•	•	•	•	•	•	•	•	•	•	•	•	•	•	•	•	•

**Construction Upgrades**

APC	PE
•	•

**Door Options**

ALF	CG	CG.BTM	CG.TOP	DPSRR	MD	MD.BTM	MD.TOP	MFO
	•			•	• <sup>†</sup>			•

<sup>†</sup>Not available on 9" and 12" wide



## WALL DOUBLE DOOR, 33" HIGH

24", 27", 30", 33", or 36"

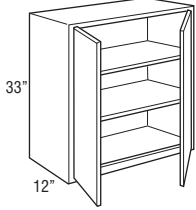

39", 42", 45", or 48"

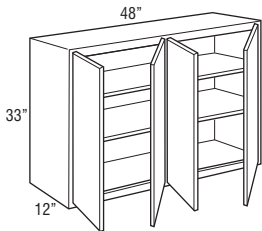
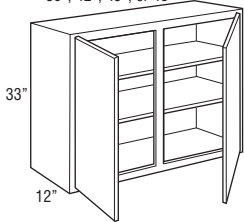

W2433

W2733

W3033

W3333

W3633

W3933

W4233

W4533

W4833CS

W4833

### Custom Modifications

ADDTK	AUTH	CBO	CCO	CFNTD	CFRMO	CND	EXBK	EX	FB	FFD	FPEB	ID	INVFRM	MIP	P	PFINBTMB	RD	TD	TVR_V	WLI	
•	•	•	•	•	•		•	•	•	•	•	•		•	•		•	•			•

### Construction Upgrades

APC	PE
•	•

### Door Options

ALF	CG	CG.BTM	CG.TOP	DPSRR	MD	MD.BTM	MD.TOP	MFO
	•			•	• <sup>†</sup>			•

<sup>†</sup>Not available on 39" wide

## WALL SINGLE DOOR, 36" HIGH

9", 12", 15", 18", 21", or 24"



W936 L or R

W1236 L or R

W1536 L or R

W1836 L or R

W2136 L or R

W2436 L or R

### Custom Modifications

ADDTK	AUTH	CBO	CCO	CFNTD	CFRMO	CND	EXBK	EX	FB	FFD	FPEB	ID	INVFRM	MIP	P	PFINBTMB	RD	TD	TVR_V	WLI	
•	•	•	•	•	•		•	•	•	•	•	•		•	•		•	•			•

### Construction Upgrades

APC	PE
•	•

### Door Options

ALF	CG	CG.BTM	CG.TOP	DPSRR	MD	MD.BTM	MD.TOP	MFO
• <sup>†</sup>	•			•	• <sup>‡</sup>			•

<sup>†</sup>Not available on 9" and 24" wide

<sup>‡</sup>Not available on 9" and 12" wide

**WALL DOUBLE DOOR, 36" HIGH**

24", 27", 30", 33", or 36"

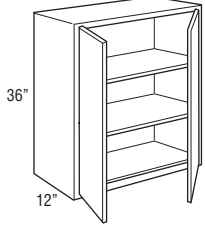

39", 42", 45", or 48"

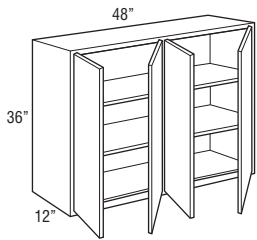
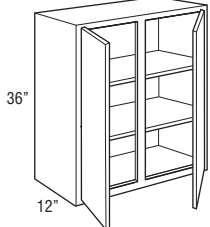

- W2436
- W2736
- W3036
- W3336
- W3636

- W3936
- W4236
- W4536
- W4836CS

**W4836**

**Custom Modifications**

ADDTK	AUTH	CBO	CCO	CFNTO	CFRMO	CND	EXBK	EX	FB	FFD	FPEB	ID	INVFRM	MIP	P	PFINBTMB	RD	TD	TVR_V	WLI
•	•	•	•	•	•		•	•	•	•	•	•		•	•	•	•			•

**Construction Upgrades**

APC	PE
•	•

**Door Options**

ALF	CG	CG.BTM	CG.TOP	DPSRR	MD	MD.BTM	MD.TOP	MFO
	•			•	•†			•

†Not available on 39" wide

**WALL SINGLE DOOR, 39" HIGH**

9", 12", 15", 18", 21" or 24"

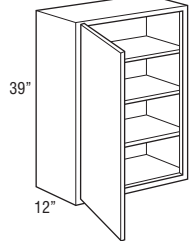

- W939 L or R
- W1239 L or R
- W1539 L or R
- W1839 L or R
- W2139 L or R
- W2439 L or R

**Custom Modifications**

ADDTK	AUTH	CBO	CCO	CFNTO	CFRMO	CND	EXBK	EX	FB	FFD	FPEB	ID	INVFRM	MIP	P	PFINBTMB	RD	TD	TVR_V	WLI
•	•	•	•	•	•		•	•	•	•	•	•		•	•	•	•			•

**Construction Upgrades**

APC	PE
•	•

**Door Options**

ALF	CG	CG.BTM	CG.TOP	DPSRR	MD	MD.BTM	MD.TOP	MFO
	•			•	•†			•

†Not available on 9" and 12" wide

## WALL DOUBLE DOOR, 39" HIGH

24", 27", 30", 33", or 36"

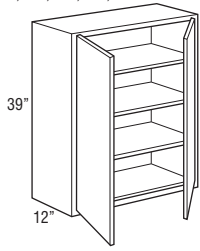

39", 42", 45", or 48"

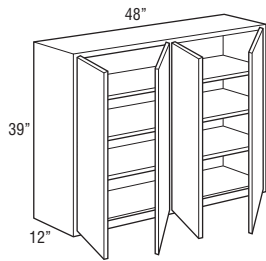
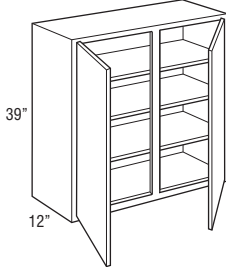

W2439

W2739

W3039

W3339

W3639

W3939

W4239

W4539

W4839CS

W4839

### Custom Modifications

ADDTK	AUTH	CBO	CCO	CFNTD	CFRMO	CND	EXBK	EX	FB	FFD	FPEB	ID	INVFRM	MIP	P	PFINBTMB	RD	TD	TVR_V	WLI	
•	•	•	•	•	•		•	•	•	•	•	•		•	•		•	•			•

### Construction Upgrades

APC	PE
•	•

### Door Options

ALF	CG	CG.BTM	CG.TOP	DPSRR	MD	MD.BTM	MD.TOP	MFO
	•			•	•†			•

†Not available on 39" wide

## WALL SINGLE DOOR, 42" HIGH

9", 12", 15", 18", 21", or 24"

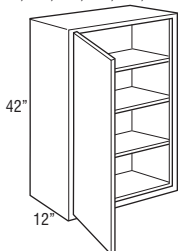

W942 L or R

W1242 L or R

W1542 L or R

W1842 L or R

W2142 L or R

W2442 L or R

### Custom Modifications

ADDTK	AUTH	CBO	CCO	CFNTD	CFRMO	CND	EXBK	EX	FB	FFD	FPEB	ID	INVFRM	MIP	P	PFINBTMB	RD	TD	TVR_V	WLI	
•	•	•	•	•	•		•	•	•	•	•	•		•	•		•	•			•

### Construction Upgrades

APC	PE
•	•

### Door Options

ALF	CG	CG.BTM	CG.TOP	DPSRR	MD	MD.BTM	MD.TOP	MFO
	•			•	•†			•

†Not available on 9" and 12" wide

**WALL DOUBLE DOOR, 42" HIGH**

24", 27", 30", 33", or 36"

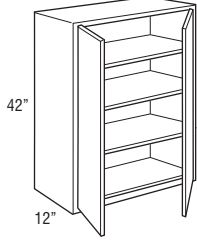

39", 42", 45", or 48"

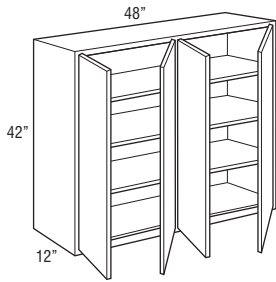
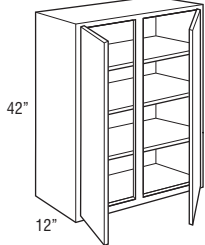

**W2442**

**W2742**

**W3042**

**W3342**

**W3642**

**W3942**

**W4242**

**W4542**

**W4842CS**

**W4842**

**Custom Modifications**

ADDTK	AUTH	CBO	CCO	CFNTO	CFRMO	CND	EXBK	EX	FB	FFD	FPEB	ID	INVFRM	MIP	P	PFINBTMB	RD	TD	TVR_V	WLI	
•	•	•	•	•	•	•	•	•	•	•	•	•	•	•	•	•	•	•	•	•	•

**Construction Upgrades**

APC	PE
•	•

**Door Options**

ALF	CG	CG.BTM	CG.TOP	DPSRR	MD	MD.BTM	MD.TOP	MFO
•	•	•	•	•	•†	•	•	•

†Not available on 39" wide

**WALL EASY ACCESS STORAGE CABINET, 30" HIGH**

15" or 18"

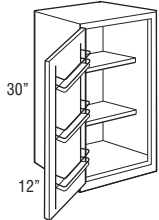

30" or 36"

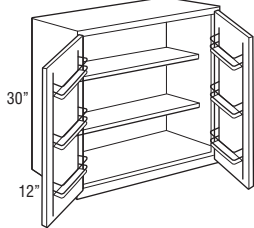

**WEAS1530 L or R**

**WEAS1830 L or R**

**WEAS3030**

**WEAS3630**

- Adjustable shelves are 7 1/2" deep.
- Each door features a chrome and wood three-tiered rack.
- Door rack width is 9 3/8" on 15" and 30" wide cabinets.
- Door rack width is 12 3/8" on 18" and 36" wide cabinets.
- Door rack depth is 3".

**Custom Modifications**

ADDTK	AUTH	CBO	CCO	CFNTO	CFRMO	CND	EXBK	EX	FB	FFD	FPEB	ID	INVFRM	MIP	P	PFINBTMB	RD	TD	TVR_V	WLI	
•	•	•	•	•	•	•	•	•	•	•	•	•	•	•	•	•	•	•	•	•	•

**Construction Upgrades**

APC	PE
•	•

**Door Options**

ALF	CG	CG.BTM	CG.TOP	DPSRR	MD	MD.BTM	MD.TOP	MFO
•	•	•	•	•	•	•	•	•

**WALL TWO DRAWER CABINET,  
18" HIGH, 12" DEEP**

12", 15", 18", 21", 24",  
27", 30", 33", or 36"

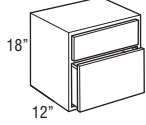

- W2D1218
- W2D1518
- W2D1818
- W2D2118
- W2D2418
- W2D2718
- W2D3018
- W2D3318
- W2D3618

**Custom Modifications**

ADDTK	AUTH	CBO	CCO	CFNTO	CFRMO	CND	EXBK	EX	FB	FFD	FPEB	ID	INVFRM	MIP	P	PFINBTMB	RD	TD	TVR_V	WLI	
•	•	•	•		•		•	•	•		•	•									

**Construction Upgrades**

APC	PE
•	•

**Door Options**

ALF	CG	CG.BTM	CG.TOP	DPSRR	MD	MD.BTM	MD.TOP	MFO

**WALL TWO DRAWER SINGLE DOOR  
CABINET, 48", 51", 54", 57",  
or 60" HIGH, 12" DEEP**

15", 18", or 24"

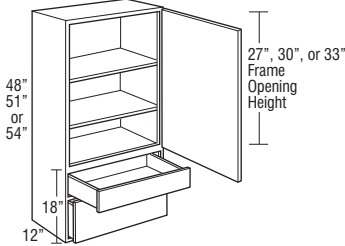

- W2D1548 L or R
- W2D1848 L or R
- W2D2448 L or R
- W2D1551 L or R
- W2D1851 L or R
- W2D2451 L or R
- W2D1554 L or R
- W2D1854 L or R
- W2D2454 L or R

15", 18", or 24"

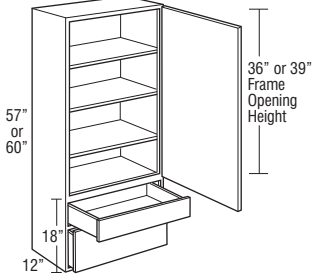

- W2D1557 L or R
- W2D1857 L or R
- W2D2457 L or R
- W2D1560 L or R
- W2D1860 L or R
- W2D2460 L or R

**Custom Modifications**

ADDTK	AUTH	CBO	CCO	CFNTO	CFRMO	CND	EXBK	EX	FB	FFD	FPEB	ID	INVFRM	MIP	P	PFINBTMB	RD	TD	TVR_V	WLI	
•	•	•	•		•	•	•	•	•		•	•		•							•

**Construction Upgrades**

APC	PE
•	•

**Door Options**

ALF	CG	CG.BTM	CG.TOP	DPSRR	MD	MD.BTM	MD.TOP	MFO
	•			•	•			•

**WALL TWO DRAWER DOUBLE DOOR CABINET, 48", 51", 54", 57", or 60" HIGH, 12" DEEP**

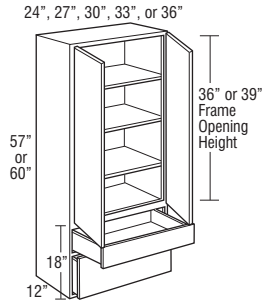
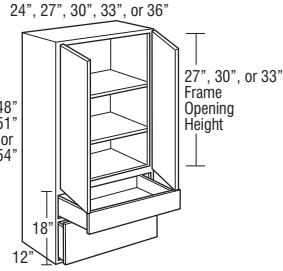

- W2D2448
- W2D2748
- W2D3048
- W2D3348
- W2D3648
- W2D2451
- W2D2751
- W2D3051
- W2D3351
- W2D3651
- W2D2454
- W2D2754
- W2D3054
- W2D3354
- W2D3654

- W2D2457
- W2D2757
- W2D3057
- W2D3357
- W2D3657
- W2D2460
- W2D2760
- W2D3060
- W2D3360
- W2D3660

**Custom Modifications**

ADDTK	AUTH	CBO	CCO	CFNTO	CFRMO	CND	EXBK	EX	FB	FFD	FPEB	ID	INVFRM	MIP	P	PFINBTMB	RD	TD	TVR_V	WLI
•	•	•	•			•	•	•	•		•	•		•						•

**Construction Upgrades**

APC	PE
•	•

**Door Options**

ALF	CG	CG.BTM	CG.TOP	DPSRR	MD	MD.BTM	MD.TOP	MFO
	•			•	•			•

**WALL THREE DRAWER SINGLE DOOR, 48", 51", 54", 57", or 60" HIGH**

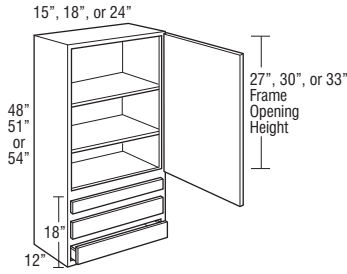

- W3D1548 L or R
- W3D1848 L or R
- W3D2448 L or R
- W3D1551 L or R
- W3D1851 L or R
- W3D2451 L or R
- W3D1554 L or R
- W3D1854 L or R
- W3D2454 L or R

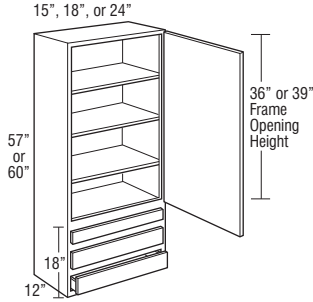

- W3D1557 L or R
- W3D1857 L or R
- W3D2457 L or R
- W3D1560 L or R
- W3D1860 L or R
- W3D2460 L or R

- Includes one shallow depth drawer and two standard drawers.
- Top drawer will be slab drawer front for all 5-piece drawer and Drawer Front Raised applications.
- Drawer front to face frame reveal is justified to the top. Bottom reveal is 1".

**Custom Modifications**

ADDTK	AUTH	CBO	CCO	CFNTO	CFRMO	CND	EXBK	EX	FB	FFD	FPEB	ID	INVFRM	MIP	P	PFINBTMB	RD	TD	TVR_V	WLI	
•	•	•	•		•	•	•	•	•	•	•	•	•	•							•

**Construction Upgrades**

APC	PE
•	•

**Door Options**

ALF	CG	CG.BTM	CG.TOP	DPSRR	MD	MD.BTM	MD.TOP	MFO
	•			•	•			•

**WALL THREE DRAWER DOUBLE DOOR, 48", 51", 54", 57", or 60" HIGH**

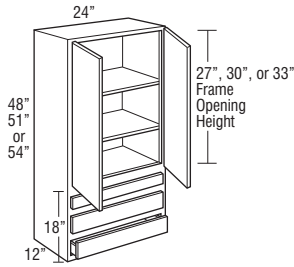

- W3D2448
- W3D2451
- W3D2454

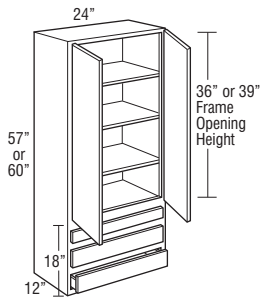

- W3D2457
- W3D2460

- Includes one shallow depth drawer and two standard drawers.
- Top drawer will be slab drawer front for all 5-piece drawer and Drawer Front Raised applications.
- Drawer front to face frame reveal is justified to the top. Bottom reveal is 1".

**Custom Modifications**

ADDTK	AUTH	CBO	CCO	CFNTO	CFRMO	CND	EXBK	EX	FB	FFD	FPEB	ID	INVFRM	MIP	P	PFINBTMB	RD	TD	TVR_V	WLI	
•	•	•	•		•	•	•	•	•	•	•	•	•	•							•

**Construction Upgrades**

APC	PE
•	•

**Door Options**

ALF	CG	CG.BTM	CG.TOP	DPSRR	MD	MD.BTM	MD.TOP	MFO
	•			•	•			•

**STACKED WALL CABINETS SINGLE DOOR, 48", 51", 54", 57", or 60" HIGH**

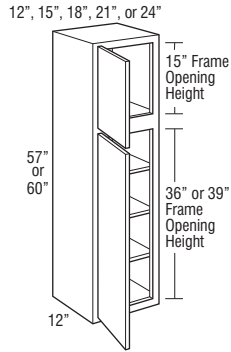
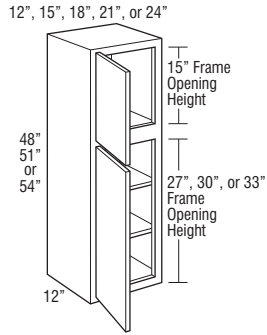

- STW1248 L or R
- STW1548 L or R
- STW1848 L or R
- STW2148 L or R
- STW2448 L or R
- STW1251 L or R
- STW1551 L or R
- STW1851 L or R
- STW2151 L or R
- STW2451 L or R
- STW1254 L or R
- STW1554 L or R
- STW1854 L or R
- STW2154 L or R
- STW2454 L or R

- STW1257 L or R
- STW1557 L or R
- STW1857 L or R
- STW2157 L or R
- STW2457 L or R
- STW1260 L or R
- STW1560 L or R
- STW1860 L or R
- STW2160 L or R
- STW2460 L or R

**Custom Modifications**

ADDTK	AUTH	CBO	CCO	CFNTO	CFRMO	CND	EXBK	EX	FB	FFD	FPEB	ID	INVFRM	MIP	P	PFINBTMB	RD	TD	TVR_V	WLI	
•	•	•	•	•	•	•	•	•	•	•	•	•	•	•	•	•	•	•	•	•	•

**Construction Upgrades**

APC	PE
•	•

**Door Options**

ALF	CG	CG.BTM	CG.TOP	DPSRR	MD	MD.BTM	MD.TOP	MFO
•	•	•	•	•	•	•†	•†	•

†Not available on 12" wide



**STACKED WALL CABINETS DOUBLE DOOR, 48", 51", 54", 57", or 60" HIGH**

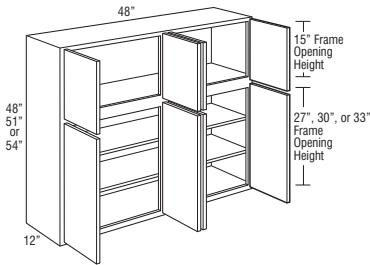
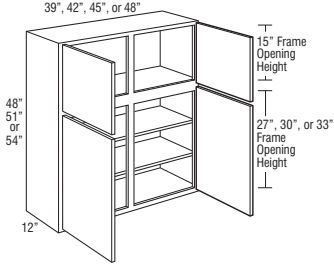
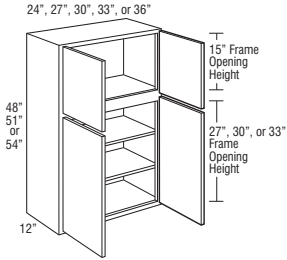

- STW2448
- STW2748
- STW3048
- STW3348
- STW3648
- STW2451
- STW2751
- STW3051
- STW3351
- STW3651
- STW2454
- STW2754
- STW3054
- STW3354
- STW3654
- STW3948
- STW4248
- STW4548
- STW4848CS
- STW3951
- STW4251
- STW4551
- STW4851CS
- STW3954
- STW4254
- STW4554
- STW4854CS

- STW4848
- STW4851
- STW4854

**Custom Modifications**

ADDTK	AUTH	CBO	CCO	CFNTO	CFRMO	CND	EXBK	EX	FB	FFD	FPEB	ID	INVFRM	MIP	P	PFINBTMB	RD	TD	TVR_V	WLI
•	•	•	•	•	•	•	•	•	•	•	•	•	•	•	•*	•	•	•*	•	•

\*Not available on 39", 42", 45", and 48" wide

**Construction Upgrades**

APC	PE
•	•

**Door Options**

ALF	CG	CG.BTM	CG.TOP	DPSRR	MD	MD.BTM	MD.TOP	MFO
•	•	•	•	•	•	• <sup>†</sup>	• <sup>†</sup>	•

<sup>†</sup>Not available on 39" wide

**STACKED WALL CABINETS DOUBLE DOOR, 48", 51", 54", 57", or 60" HIGH (cont'd)**

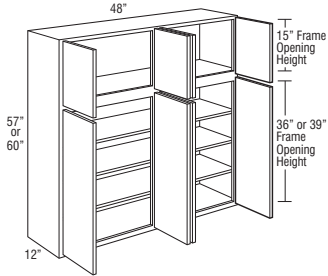
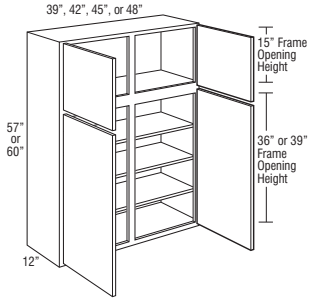
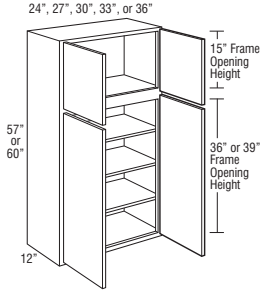

- STW2457
- STW2757
- STW3057
- STW3357
- STW3657
- STW2460
- STW2760
- STW3060
- STW3360
- STW3660

- STW3957
- STW4257
- STW4557
- STW4857CS
- STW3960
- STW4260
- STW4560
- STW4860CS

- STW4857
- STW4860

**Custom Modifications**

ADDTK	AUTH	CBO	CCO	CFNTO	CFRMO	CND	EXBK	EX	FB	FFD	FPEB	ID	INVFRM	MIP	P	PFINBTMB	RD	TD	TVR_V	WLI
•	•	•	•	•	•		•	•	•	•	•	•	•	•	•*	•	•	•*		•

\*Not available on 39", 42", 45", and 48" wide

**Construction Upgrades**

APC	PE
•	•

**Door Options**

ALF	CG	CG.BTM	CG.TOP	DPSRR	MD	MD.BTM	MD.TOP	MFO
		•	•	•		•†	•†	•

†Not available on 39" wide

### Wall Corner Cabinets

- Wall corner cabinets may be installed flush to the wall (left) or pulled up to 3" away from wall (right) to accommodate odd dimensions in a kitchen design. In either case, the adjoining run of 12" wall cabinets plus a 3" filler will butt against the solid-wood panel.
- When a cabinet is "pulled" it will use proportionally more wall space, for example, a 30" wide WC pulled 2" will use 32" of space.
- The L or R in the cabinet's nomenclature indicates the location of cabinet void.
- Blind side of wall corner cabinets cannot be installed next to a range hood or microwave shelf unit due to door interference.

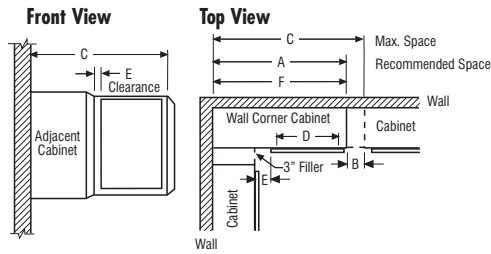

NOTE: All outside stiles are 1 1/2" wide

Model	A Recommended Space	B Max. Pull*	C Max. Space	D Face Frame Opening	E* Full Overlay At Min. At Max.		F Actual Cabinet
WC24../STWC24..	24"	5"	29"	7 1/2"	1 3/4"	6 3/4"	24"
WC27../STWC27..	27"	4 1/2"	31 1/2"	9"	3 1/4"	7 3/4"	27"
WC30../STWC30..	30"	5"	35"	13 1/2"	1 3/4"	6 3/4"	30"
WC33../STWC33..	33"	4 1/2"	37 1/2"	15"	3 1/4"	7 3/4"	33"
WC36../STWC36..	36"	5"	41"	19 1/2"	1 3/4"	6 3/4"	36"
WC39../STWC39..	39"	4 1/2"	43 1/2"	21"	3 1/4"	7 3/4"	39"
WC42../STWC42..	42"	4 1/2"	46 1/2"	24"	3 1/4"	7 3/4"	42"
WC45../STWC45..	45"	4 1/2"	49 1/2"	27"	3 1/4"	7 3/4"	45"
WC48../STWC48..	48"	4 1/2"	52 1/2"	30"	3 1/4"	7 3/4"	48"

\*Minimum/maximum space between inside edge of door and face of filler/adjointing cabinet.  
If cabinet is pulled to maximum stated dimension, filler will need to be cleated for proper attachment.

### WALL CORNER SINGLE DOOR, 24" or 27" HIGH

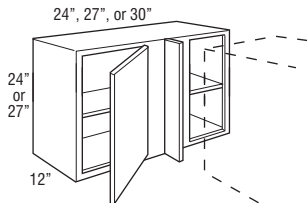

- WC2424 L or R
- WC2724 L or R
- WC3024 L or R
- WC2427 L or R
- WC2727 L or R
- WC3027 L or R

- Includes one 3" filler, shipped unattached.
- L or R indicates void. R (right) void shown.

#### Custom Modifications

ADDTK	AUTH	CBO	CCO	CFNTO	CFRMO	CND	EXBK	EX	FB	FFD	FPEB	ID	INVFRM	MIP	P	PFINBTMB	RD	TD	TVR_V	WLI
•	•	•	•	•	•	•	•	•	•	•*	•	•	•	•	•	•	•	•	•	•

\*Face Frame and Door on End modification not available on the void side of the cabinet.

#### Construction Upgrades

APC	PE
•	•

#### Door Options

ALF	CG	CG.BTM	CG.TOP	DPSRR	MD	MD.BTM	MD.TOP	MFO
•	•	•	•	•	•	•	•	•

**WALL CORNER SINGLE DOOR,  
30", 33", or 36" HIGH**

24", 27", 30", 33", or 36"

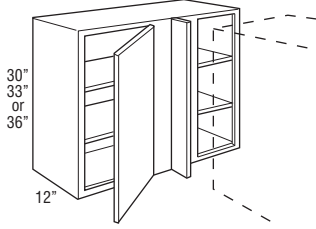

- WC2430 L or R
- WC2730 L or R
- WC3030 L or R
- WC3330 L or R
- WC3630 L or R
- WC2433 L or R
- WC2733 L or R
- WC3033 L or R
- WC3333 L or R
- WC3633 L or R
- WC2436 L or R
- WC2736 L or R
- WC3036 L or R
- WC3336 L or R
- WC3636 L or R

- Includes one 3" filler, shipped unattached.
- L or R indicates void. R (right) void shown.

**Custom Modifications**

ADDTK	AUTH	CBO	CCO	CFNTO	CFRMO	CND	EXBK	EX	FB	FFD	FPEB	ID	INVFRM	MIP	P	PFINBTMB	RD	TD	TVR_V	WLI
•	•	•	•	•	•	•	•	•	•	•*	•	•	•	•	•	•	•	•	•	•

\*Face Frame and Door on End modification not available on the void side of the cabinet.

**Construction Upgrades**

APC	PE
•	•

**Door Options**

ALF	CG	CG.BTM	CG.TOP	DPSRR	MD	MD.BTM	MD.TOP	MFO
•	•	•	•	•	•†	•	•	•

†Available only on 30", 33", and 36" wide

**WALL CORNER DOUBLE DOOR,  
30", 33", or 36" HIGH**

39", 42", 45", or 48"

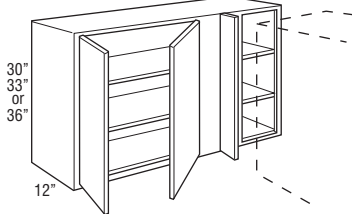

- WC3930 L or R
- WC4230 L or R
- WC4530 L or R
- WC4830 L or R
- WC3933 L or R
- WC4233 L or R
- WC4533 L or R
- WC4833 L or R
- WC3936 L or R
- WC4236 L or R
- WC4536 L or R
- WC4836 L or R

- Includes one 3" filler, shipped unattached.
- L or R indicates void. R (right) void shown.
- On 39" wide cabinets, Peninsula and Mullion Door options cannot be ordered together due to the unavailability of Mullion Doors for the double door side.

**Custom Modifications**

ADDTK	AUTH	CBO	CCO	CFNTO	CFRMO	CND	EXBK	EX	FB	FFD	FPEB	ID	INVFRM	MIP	P	PFINBTMB	RD	TD	TVR_V	WLI
•	•	•	•	•	•	•	•	•	•	•*	•	•	•	•	•	•	•	•	•	•

\*Face Frame and Door on End modification not available on the void side of the cabinet.

**Construction Upgrades**

APC	PE
•	•

**Door Options**

ALF	CG	CG.BTM	CG.TOP	DPSRR	MD	MD.BTM	MD.TOP	MFO
•	•	•	•	•	•	•	•	•

**WALL CORNER SINGLE DOOR,  
39" or 42" HIGH**

24", 27", 30", 33", or 36"

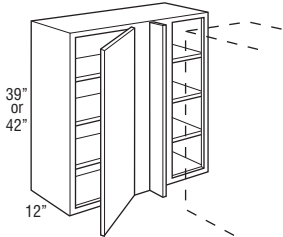

- WC2439 L or R
- WC2739 L or R
- WC3039 L or R
- WC3339 L or R
- WC3639 L or R
- WC2442 L or R
- WC2742 L or R
- WC3042 L or R
- WC3342 L or R
- WC3642 L or R

- Includes one 3" filler, shipped unattached.
- L or R indicates void. R (right) void shown.

**Custom Modifications**

ADDTK	AUTH	CBO	CCO	CFNTD	CFRMO	CND	EXBK	EX	FB	FFD	FPEB	ID	INVFRM	MIP	P	PFINBTMB	RD	TD	TVR_V	WLI
•	•	•	•	•	•		•	•	•	•*	•	•		•	•	•	•			•

\*Face Frame and Door on End modification not available on the void side of the cabinet.

**Construction Upgrades**

APC	PE
•	•

**Door Options**

ALF	CG	CG.BTM	CG.TOP	DPSRR	MD	MD.BTM	MD.TOP	MFO
	•			•	•†			•

†Available only on 30", 33", and 36" wide

**WALL CORNER DOUBLE DOOR,  
39" or 42" HIGH**

39", 42", 45", or 48"

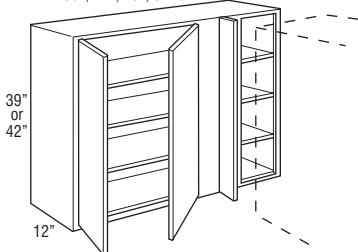

- WC3939 L or R
- WC4239 L or R
- WC4539 L or R
- WC4839 L or R
- WC3942 L or R
- WC4242 L or R
- WC4542 L or R
- WC4842 L or R

- Includes one 3" filler, shipped unattached.
- L or R indicates void. R (right) void shown.
- On 39" wide cabinets, Peninsula and Mullion Door options cannot be ordered together due to the unavailability of Mullion Doors for the double door side.

**Custom Modifications**

ADDTK	AUTH	CBO	CCO	CFNTD	CFRMO	CND	EXBK	EX	FB	FFD	FPEB	ID	INVFRM	MIP	P	PFINBTMB	RD	TD	TVR_V	WLI
•	•	•	•	•	•		•	•	•	•*	•	•		•	•	•	•			•

\*Face Frame and Door on End modification not available on the void side of the cabinet.

**Construction Upgrades**

APC	PE
•	•

**Door Options**

ALF	CG	CG.BTM	CG.TOP	DPSRR	MD	MD.BTM	MD.TOP	MFO
	•			•	•			•

**STACKED WALL CORNER SINGLE DOOR, 48", 51", 54", 57", or 60" HIGH**

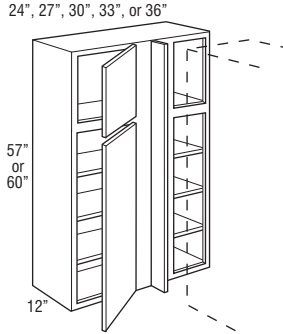
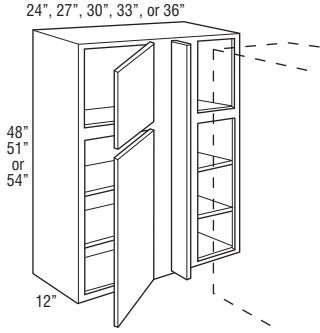

- STWC2448 L or R
- STWC2748 L or R
- STWC3048 L or R
- STWC3348 L or R
- STWC3648 L or R
- STWC2451 L or R
- STWC2751 L or R
- STWC3051 L or R
- STWC3351 L or R
- STWC3651 L or R
- STWC2454 L or R
- STWC2754 L or R
- STWC3054 L or R
- STWC3354 L or R
- STWC3654 L or R

- STWC2457 L or R
- STWC2757 L or R
- STWC3057 L or R
- STWC3357 L or R
- STWC3657 L or R
- STWC2460 L or R
- STWC2760 L or R
- STWC3060 L or R
- STWC3360 L or R
- STWC3660 L or R

- Includes one 3" filler, shipped unattached.
- L or R indicates void. R (right) void shown.

**Custom Modifications**

ADDTK	AUTH	CBO	CCO	CFNTO	CFRMO	CND	EXBK	EX	FB	FFD	FPEB	ID	INVFRM	MIP	P	PFINBTMB	RD	TD	TVR_V	WLI
•	•	•	•	•	•	•	•	•	•	•*	•	•	•	•	•	•	•	•	•	•

\*Face Frame and Door on End modification not available on the void side of the cabinet.

**Construction Upgrades**

APC	PE
•	•

**Door Options**

ALF	CG	CG.BTM	CG.TOP	DPSRR	MD	MD.BTM	MD.TOP	MFO
•	•	•	•	•	•	•†	•†	•

†Available only on 30", 33", and 36" wide

**STACKED WALL CORNER  
DOUBLE DOOR, 48", 51",  
54", 57", or 60" HIGH**

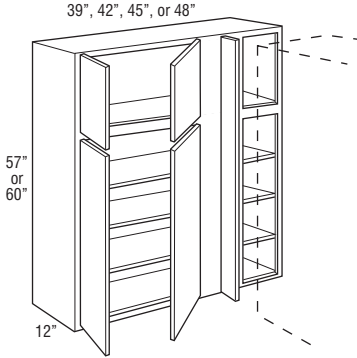
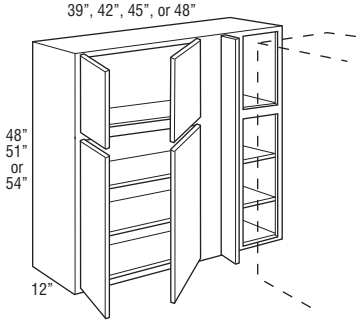

- STWC3948 L or R
- STWC4248 L or R
- STWC4548 L or R
- STWC4848 L or R
- STWC3951 L or R
- STWC4251 L or R
- STWC4551 L or R
- STWC4851 L or R
- STWC3954 L or R
- STWC4254 L or R
- STWC4554 L or R
- STWC4854 L or R

- STWC3957 L or R
- STWC4257 L or R
- STWC4557 L or R
- STWC4857 L or R
- STWC3960 L or R
- STWC4260 L or R
- STWC4560 L or R
- STWC4860 L or R

- Includes one 3" filler, shipped unattached.
- L or R indicates void. R (right) void shown.

**Custom Modifications**

ADTK	AUTH	CBO	CCO	CFNTD	CFRMO	CND	EXBK	EX	FB	FFD	FPEB	ID	INVFRM	MIP	P	PFINBTMB	RD	TD	TVR_V	WLI
•	•	•	•	•	•		•	•	•	•*	•	•	•	•		•	•			•

\*Face Frame and Door on End modification not available on the void side of the cabinet.

**Construction Upgrades**

APC	PE
•	•

**Door Options**

ALF	CG	CG.BTM	CG.TOP	DPSRR	MD	MD.BTM	MD.TOP	MFO
		•	•	•		•†	•†	•

†Not available on 39" wide

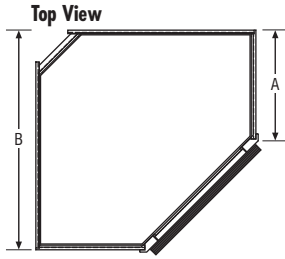

Diagonal Wall Cabinets with Increased or Reduced Depth

	RD9	RD10	RD11	STD	ID13	ID14	ID15	ID16	ID17	ID18	ID19	ID20	ID21	ID22	ID23	ID24
Cabinet Depth A	9"	10"	11"	12"	13"	14"	15"	16"	17"	18"	19"	20"	21"	22"	23"	24"
Wall Space B	21"	22"	23"	24"	25"	26"	27"	28"	29"	30"	31"	32"	33"	34"	35"	36"

**DIAGONAL WALL, 12", 15", or 18" HIGH, 24" x 24"**

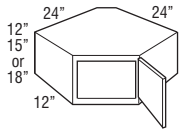

- DW122424 L or R
- DW152424 L or R
- DW182424 L or R

- Cabinets require 24" x 24" of corner wall space.
- Full overlay styles use 14 1/2" wide doors with 38NPOHINGE to allow for proper door clearance with adjacent cabinets.

**Custom Modifications**

ADDTK	AUTH	CBO	CCO	CFNTO	CFRMO	CND	EXBK	EX	FB	FFD	FPEB	ID	INVFRM	MIP	P	PFINBTMB	RD	TD	TVR_V	WLI	
	•		•	•	•				•	•*	•	•		•		•	•				•

\*Available only on 18" high

**Construction Upgrades**

APC	PE
•	•

**Door Options**

ALF	CG	CG.BTM	CG.TOP	DPSRR	MD	MD.BTM	MD.TOP	MFO
	•			•	•†			•

†Not available on 12" high

**DIAGONAL WALL, 24" or 27" HIGH, 24" x 24"**

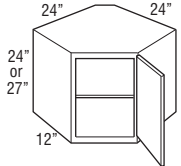

- DW242424 L or R
- DW272424 L or R

- Cabinets require 24" x 24" of corner wall space.
- Adjustable shelf cannot be removed/retrofitted.
- Full overlay styles use 14 1/2" wide doors with 38NPOHINGE to allow for proper door clearance with adjacent cabinets.

**Custom Modifications**

ADDTK	AUTH	CBO	CCO	CFNTO	CFRMO	CND	EXBK	EX	FB	FFD	FPEB	ID	INVFRM	MIP	P	PFINBTMB	RD	TD	TVR_V	WLI	
	•	•	•	•	•				•	•	•	•		•		•	•				•

**Construction Upgrades**

APC	PE
•	•

**Door Options**

ALF	CG	CG.BTM	CG.TOP	DPSRR	MD	MD.BTM	MD.TOP	MFO
	•			•	•†			•

†Not available on 27" high

**DIAGONAL WALL, 30", 33", 36", 39", or 42" HIGH, 24" x 24"**

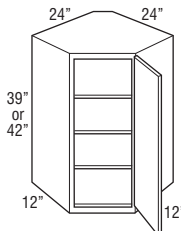
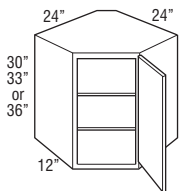

- DW302424 L or R
- DW332424 L or R
- DW362424 L or R

- DW392424 L or R
- DW422424 L or R

- Cabinets require 24" x 24" of corner wall space.
- Adjustable shelves.
- Full overlay styles use 14 1/2" wide doors with 38NPOHINGE to allow for proper door clearance with adjacent cabinets.

**Custom Modifications**

ADDTK	AUTH	CBO	CCO	CFNTO	CFRMO	CND	EXBK	EX	FB	FFD	FPEB	ID	INVFRM	MIP	P	PFINBTMB	RD	TD	TVR_V	WLI	
	•	•	•	•	•				•	•	•	•		•		•	•				•

**Construction Upgrades**

APC	PE
•	•

**Door Options**

ALF	CG	CG.BTM	CG.TOP	DPSRR	MD	MD.BTM	MD.TOP	MFO
	•			•	•			•



**DIAGONAL WALL, 12", 15", or 18" HIGH, 27" x 27"**

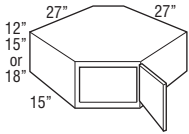

**DW122727 L or R**  
**DW152727 L or R**  
**DW182727 L or R**

- Cabinets require 27" x 27" of corner wall space.
- Full overlay styles use 14 1/2" wide doors with 38NPOHINGE to allow for proper door clearance with adjacent cabinets.

**Custom Modifications**

ADDTK	AUTH	CBO	CCO	CFNTD	CFRMO	CND	EXBK	EX	FB	FFD	FPEB	ID	INVFRM	MIP	P	PFINBTMB	RD	TD	TVR_V	WLI	
	•		•	•	•				•	•*	•	•		•			•	•			•

\*Available only on 18" high

**Construction Upgrades**

APC	PE
•	•

**Door Options**

ALF	CG	CG.BTM	CG.TOP	DPSRR	MD	MD.BTM	MD.TOP	MFO
	•			•	•†			•

†Not available on 12" high

**DIAGONAL WALL, 24" or 27" HIGH, 27" x 27"**

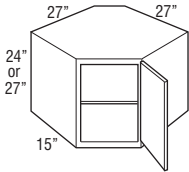

**DW242727 L or R**  
**DW272727 L or R**

- Cabinets require 27" x 27" of corner wall space.
- Adjustable shelf cannot be removed/retrofitted.
- Full overlay styles use 14 1/2" wide doors with 38NPOHINGE to allow for proper door clearance with adjacent cabinets.

**Custom Modifications**

ADDTK	AUTH	CBO	CCO	CFNTD	CFRMO	CND	EXBK	EX	FB	FFD	FPEB	ID	INVFRM	MIP	P	PFINBTMB	RD	TD	TVR_V	WLI	
	•	•	•	•	•				•	•	•	•		•			•	•			•

**Construction Upgrades**

APC	PE
•	•

**Door Options**

ALF	CG	CG.BTM	CG.TOP	DPSRR	MD	MD.BTM	MD.TOP	MFO
	•			•	•†			•

†Not available on 27" high

**DIAGONAL WALL, 30", 33", 36", 39", or 42" HIGH, 27" x 27"**

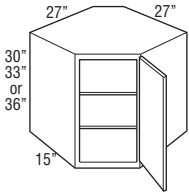

**DW302727 L or R**  
**DW332727 L or R**  
**DW362727 L or R**

**DW392727 L or R**  
**DW422727 L or R**

- Cabinets require 27" x 27" of corner wall space.
- Full overlay styles use 14 1/2" wide doors with 38NPOHINGE to allow for proper door clearance with adjacent cabinets.

**Custom Modifications**

ADDTK	AUTH	CBO	CCO	CFNTD	CFRMO	CND	EXBK	EX	FB	FFD	FPEB	ID	INVFRM	MIP	P	PFINBTMB	RD	TD	TVR_V	WLI	
	•	•	•	•	•				•	•	•	•		•			•	•			•

**Construction Upgrades**

APC	PE
•	•

**Door Options**

ALF	CG	CG.BTM	CG.TOP	DPSRR	MD	MD.BTM	MD.TOP	MFO
	•			•	•			•

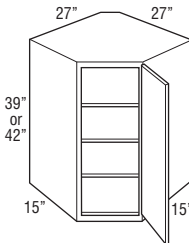

**DIAGONAL WALL with LAZY SUSAN, 30", 33", 36", 39", or 42" HIGH, 24" x 24"**

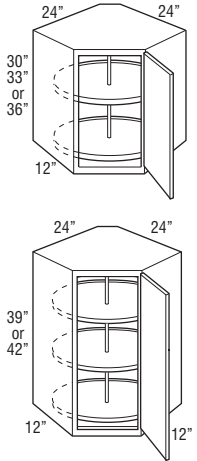

DW302424S L or R  
 DW332424S L or R  
 DW362424S L or R

DW392424S L or R  
 DW422424S L or R

- Cabinets require 24" x 24" of corner wall space.
- Plywood shelves are 18" in overall diameter with a 17" interior diameter and 1" high lip.
- Shelves rotate independently.
- Full overlay styles use 14 1/2" wide doors with 38NPOHINGE to allow for proper door clearance with adjacent cabinets.

**Custom Modifications**

ADDTK	AUTH	CBO	CCO	CFNTO	CFRMO	CND	EXBK	EX	FB	FFD	FPEB	ID	INVFRM	MIP	P	PFINBTMB	RD	TD	TVR_V	WLI
	•	•	•	•	•				•	•	•			•		•				•

**Construction Upgrades**

APC	PE
•	•

**Door Options**

ALF	CG	CG.BTM	CG.TOP	DPSRR	MD	MD.BTM	MD.TOP	MFO
	•			•	•			•

**DIAGONAL WALL with LOWER DOOR, 48", 51", 54", 57", or 60" HIGH, 24" x 24"**

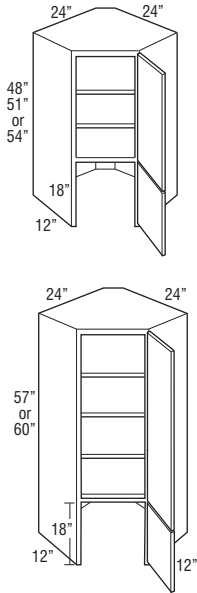

DW302424D L or R  
 DW332424D L or R  
 DW362424D L or R

DW392424D L or R  
 DW422424D L or R

- Cabinets require 24" x 24" of corner wall space.
- Lower section of cabinet does not have a bottom (floor).
- Mullion Doors not available on bottom door.
- Full overlay styles use 14 1/2" wide doors with 38NPOHINGE to allow for proper door clearance with adjacent cabinets.

**Custom Modifications**

ADDTK	AUTH	CBO	CCO	CFNTO	CFRMO	CND	EXBK	EX	FB	FFD	FPEB	ID	INVFRM	MIP	P	PFINBTMB	RD	TD	TVR_V	WLI
	•	•	•	•	•				•		•			•			•			•

**Construction Upgrades**

APC	PE
•	•

**Door Options**

ALF	CG	CG.BTM	CG.TOP	DPSRR	MD	MD.BTM	MD.TOP	MFO
		•	•	•			•	•

**DIAGONAL WALL with LOWER DOOR, 48", 51", 54", 57", or 60" HIGH, 27" x 27"**

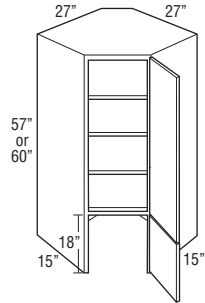
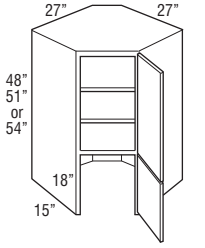

DW302727D L or R  
DW332727D L or R  
DW362727D L or R

DW392727D L or R  
DW422727D L or R

- Cabinets require 27" x 27" of corner wall space.
- Lower section of cabinet does not have a bottom (floor).
- Mullion Doors not available on bottom door.
- Full overlay styles use 14 1/2" wide doors with 38NPOHINGE to allow for proper door clearance with adjacent cabinets.

**Custom Modifications**

ADDTK	AUTH	CBO	CCO	CFNTO	CFRMO	CND	EXBK	EX	FB	FFD	FPEB	ID	INVFRM	MIP	P	PFINBTMB	RD	TD	TVR_V	WLI	
	•	•	•	•	•				•		•	•		•				•			•

**Construction Upgrades**

APC	PE
•	•

**Door Options**

ALF	CG	CG.BTM	CG.TOP	DPSRR	MD	MD.BTM	MD.TOP	MFO
		•	•	•			•	•

**DIAGONAL WALL with LOWER DOOR and LAZY SUSAN, 48", 51", 54", 57", or 60" HIGH, 24" x 24"**

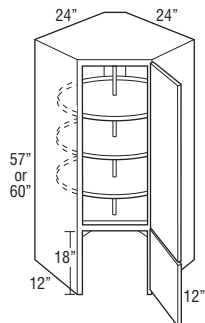
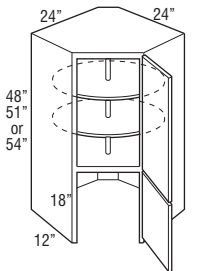

DW302424DS L or R  
DW332424DS L or R  
DW362424DS L or R

DW392424DS L or R  
DW422424DS L or R

- Cabinets require 24" x 24" of corner wall space.
- Lower section of cabinet does not have a bottom (floor).
- Mullion Doors not available on bottom door.
- Plywood shelves are 18" in overall diameter with a 17" interior diameter and 1" high lip.
- Shelves rotate independently.
- Full overlay styles use 14 1/2" wide doors with 38NPOHINGE to allow for proper door clearance with adjacent cabinets.

**Custom Modifications**

ADDTK	AUTH	CBO	CCO	CFNTO	CFRMO	CND	EXBK	EX	FB	FFD	FPEB	ID	INVFRM	MIP	P	PFINBTMB	RD	TD	TVR_V	WLI	
	•	•	•	•	•				•		•	•		•				•			•

**Construction Upgrades**

APC	PE
•	•

**Door Options**

ALF	CG	CG.BTM	CG.TOP	DPSRR	MD	MD.BTM	MD.TOP	MFO
		•	•	•			•	•

**STACKED DIAGONAL WALL,  
48", 51", 54", 57", or 60" HIGH,  
24" x 24"**

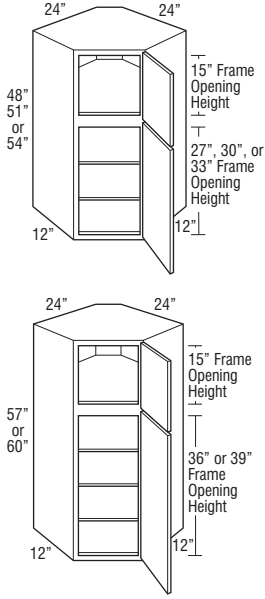

- STDW482424 L or R
- STDW512424 L or R
- STDW542424 L or R

**STDW572424 L or R  
STDW602424 L or R**

- Cabinet requires 24" x 24" of corner wall space.
- Full overlay styles use 14 1/2" wide doors with 38NPOHINGE to allow for proper door clearance with adjacent cabinets.

**Custom Modifications**

ADDTK	AUTH	CBO	CCO	CFNTO	CFRMO	CND	EXBK	EX	FB	FFD	FPEB	ID	INVFRM	MIP	P	PFINBTMB	RD	TD	TVR_V	WLI
	•	•	•	•	•				•		•	•	•	•		•	•			•

**Construction Upgrades**

APC	PE
•	•

**Door Options**

ALF	CG	CG.BTM	CG.TOP	DPSRR	MD	MD.BTM	MD.TOP	MFO
		•	•	•		•	•	•

**STACKED DIAGONAL WALL,  
48", 51", 54", 57", or 60" HIGH,  
27" x 27"**

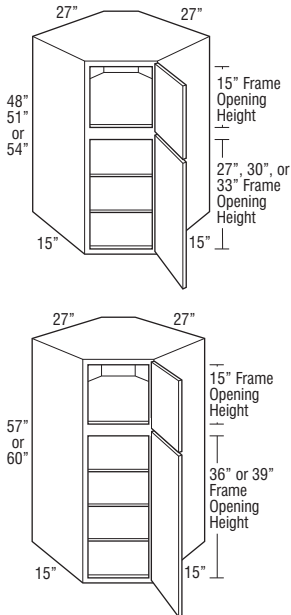

- STDW482727 L or R
- STDW512727 L or R
- STDW542727 L or R

**STDW572727 L or R  
STDW602727 L or R**

- Cabinet requires 27" x 27" of corner wall space.
- Full overlay styles use 14 1/2" wide doors with 38NPOHINGE to allow for proper door clearance with adjacent cabinets.

**Custom Modifications**

ADDTK	AUTH	CBO	CCO	CFNTO	CFRMO	CND	EXBK	EX	FB	FFD	FPEB	ID	INVFRM	MIP	P	PFINBTMB	RD	TD	TVR_V	WLI
	•	•	•	•	•				•		•	•	•	•		•	•			•

**Construction Upgrades**

APC	PE
•	•

**Door Options**

ALF	CG	CG.BTM	CG.TOP	DPSRR	MD	MD.BTM	MD.TOP	MFO
		•	•	•		•	•	•

**DIAGONAL WALL PENINSULA,  
30", 33", 36", 39", or 42" HIGH,  
24" x 24 1/4"**

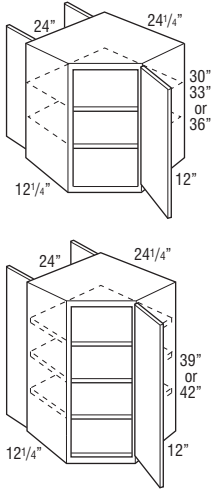

- DW302424PLL
- DW302424PLR
- DW302424PRL
- DW302424PRR
- DW332424PLL
- DW332424PLR
- DW332424PRL
- DW332424PRR
- DW362424PLL
- DW362424PLR
- DW362424PRL
- DW362424PRR

- DW392424PLL\*
- DW392424PLR\*
- DW392424PRL\*
- DW392424PRR\*
- DW422424PLL\*
- DW422424PLR\*
- DW422424PRL\*
- DW422424PRR\*

- RL door hinging shown.
- Full overlay styles use 1 1/2" wide doors with 38NPOHINGE to allow for proper door clearance with adjacent cabinets.
- \*When ordered with MD, shelves will not align with mullions.

**Diagonal Wall Peninsula**

Diagonals are different. All PLL, PLR, etc. designations refer to wall openings as well as hinge location. A PLL is left hinged on the kitchen (DW) side. Peninsula side is 24" wide and features butt doors. The second L or R in the product code indicates the position of the butt doors relative to the DW side.

**NOTE:**

All Peninsula wall cabinets must be fully supported by screws installed in a structural member in the ceiling or soffit, and into adjacent cabinets or tall panels. Weight load limit is 15 lbs. per square foot.

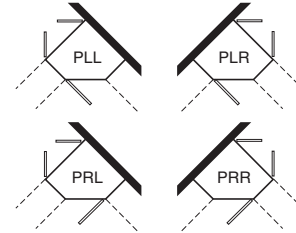

**Custom Modifications**

ADDTK	AUTH	CBO	CCO	CFNTO	CFRMO	CND	EXBK	EX	FB	FFD	FPEB	ID	INVFRM	MIP	P	PFINBTMB	RD	TD	TVR_V	WLI
		•	•	•	•				•		•			•	STD	•				•

**Construction Upgrades**

APC	PE
•	•

**Door Options**

ALF	CG	CG.BTM	CG.TOP	DPSRR	MD	MD.BTM	MD.TOP	MFO
	•			•	•			•

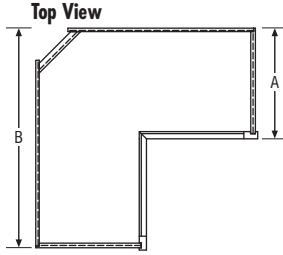

Easy Reach Wall Corner Cabinets with Increased or Reduced Depth

	RD9	RD10	RD11	STD	ID13	ID14	ID15	ID16	ID17	ID18	ID19	ID20	ID21	ID22	ID23	ID24	
Cabinet Depth (ER_2424)	A	9"	10"	11"	12"	13"	14"	15"	16"	17"	18"	19"	20"	21"	22"	23"	24"
Wall Space (ER_2424)	B	21"	22"	23"	24"	25"	26"	27"	28"	29"	30"	31"	32"	33"	34"	35"	36"
Cabinet Depth (ER_2121)	A	9"	10"	11"	12"	13"	14"	15"	16"	17"	18"	19"	20"	21"	22"	23"	24"
Wall Space (ER_2121)	B	18"	19"	20"	21"	22"	23"	24"	25"	26"	27"	28"	29"	30"	31"	32"	33"

**EASY REACH WALL CORNER, 30", 33", 36", 39", or 42" HIGH, 21" x 21"**

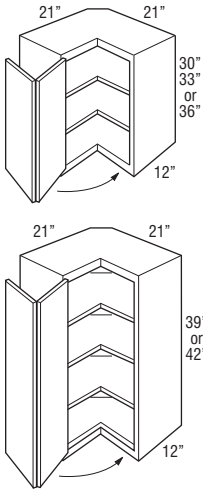

**ER302121 L or R**  
**ER332121 L or R**  
**ER362121 L or R**

**ER392121 L or R**  
**ER422121 L or R**

- Decorative hardware screws must be countersunk to prevent scratching of adjacent cabinets and face frame of ER.
- Adjustable shelves.
- Hinged door opens 170°.
- Integrated soft-close hinge not included.

**Custom Modifications**

ADDTK	AUTH	CBO	CCO	CFNTO	CFRMO	CND	EXBK	EX	FB	FFD	FPEB	ID	INVFRM	MIP	P	PFINBTMB	RD	TD	TVR_V	WLI	
	•	•	•						•		•	•		•			•				•

**Construction Upgrades**

APC	PE
•	•

**Door Options**

ALF	CG	CG.BTM	CG.TOP	DPSRR	MD	MD.BTM	MD.TOP	MFO
				•				•

**EASY REACH WALL CORNER, 30", 33", 36", 39", or 42" HIGH, 24" x 24"**

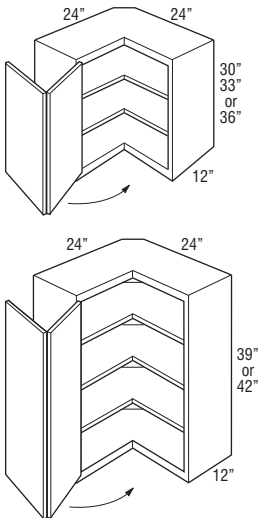

**ER30 L or R**  
**ER33 L or R**  
**ER36 L or R**

**ER39 L or R**  
**ER42 L or R**

- Requires 24" x 24" of corner wall space.
- Decorative hardware screws must be countersunk to prevent scratching of adjacent cabinets and face frame of ER.
- Adjustable shelves.
- Hinged door opens 170°.
- Integrated soft-close hinge not included.

**Custom Modifications**

ADDTK	AUTH	CBO	CCO	CFNTO	CFRMO	CND	EXBK	EX	FB	FFD	FPEB	ID	INVFRM	MIP	P	PFINBTMB	RD	TD	TVR_V	WLI	
	•	•	•						•		•	•		•			•				•

**Construction Upgrades**

APC	PE
•	•

**Door Options**

ALF	CG	CG.BTM	CG.TOP	DPSRR	MD	MD.BTM	MD.TOP	MFO
				•				•

**ASYMMETRICAL EASY REACH WALL CORNER, 30", 33", 36", 39", or 42" HIGH**

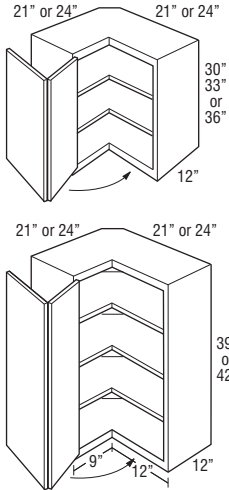

- ER302124 L or R
- ER302421 L or R
- ER332124 L or R
- ER332421 L or R
- ER362124 L or R
- ER362421 L or R

- ER392124 L or R
- ER392421 L or R
- ER422124 L or R
- ER422421 L or R

- Hinged door opens to 170°.
- Adjustable shelves.
- Legs at the front frames are 9" on 21" leg and 12" on 24" leg.
- Nomenclature for asymmetrical cabinets reads as follows:  
 First set of numbers = height  
 Second set of numbers = left side  
 Third set of numbers = right side
- Decorative hardware screws must be countersunk to prevent scratching of adjacent cabinets and face frame of ER.
- ER\_ \_2124L shown.
- Integrated soft-close hinge not included.

**Custom Modifications**

ADDTK	AUTH	CBO	CCO	CFNTO	CFRMO	CND	EXBK	EX	FB	FFD	FPEB	ID	INVFRM	MIP	P	PFINBTMB	RD	TD	TVR_V	WLI	
	•	•	•						•		•	•		•			•	•			•

**Construction Upgrades**

APC	PE
•	•

**Door Options**

ALF	CG	CG.BTM	CG.TOP	DPSRR	MD	MD.BTM	MD.TOP	MFO
				•				•

**135° CORNER INSIDE WALL, 30", 33", or 36" HIGH**

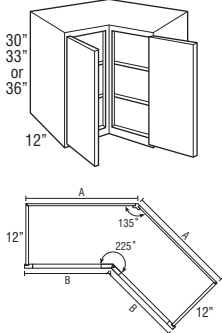

- W2130CIA
- W2430CIA
- W2730CIA
- W2133CIA
- W2433CIA
- W2733CIA
- W2136CIA
- W2436CIA
- W2736CIA

- Doors are hinged on outside of frame.
- Adjustable shelves cannot be removed from cabinet.

**Custom Modifications**

ADDTK	AUTH	CBO	CCO	CFNTO	CFRMO	CND	EXBK	EX	FB	FFD	FPEB	ID	INVFRM	MIP	P	PFINBTMB	RD	TD	TVR_V	WLI	
		•	•						•		•			•			•				•

**Construction Upgrades**

APC	PE
•	•

**Door Options**

ALF	CG	CG.BTM	CG.TOP	DPSRR	MD	MD.BTM	MD.TOP	MFO
	•			•	•†			•

†Available only on W2430CIA, W2433CIA, and W2436CIA

Model	A Dimension	B Dimension
W21(*)CIA	21"	16 1/16"
W24(*)CIA	24"	19 1/16"
W27(*)CIA	27"	22 1/16"

A indicates back width of cabinet and wall space.  
 (\*) indicates height of cabinet.  
 B indicates face frame width.

**135° CORNER INSIDE WALL,  
39" or 42" HIGH**

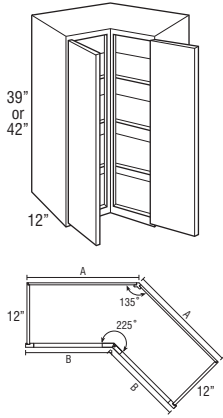

Model	A Dimension	B Dimension
W21(*)CIA	21"	16 1/16"
W24(*)CIA	24"	19 1/16"
W27(*)CIA	27"	22 1/16"

A indicates back width of cabinet and wall space.  
(\*) indicates height of cabinet.  
B indicates face frame width.

- W2139CIA
- W2439CIA
- W2739CIA
- W2142CIA
- W2442CIA
- W2742CIA

- Doors are hinged on outside of frame.
- Adjustable shelves cannot be removed from cabinet.

**Custom Modifications**

ADDTK	AUTH	CBO	CCO	CFNTO	CFRMO	CND	EXBK	EX	FB	FFD	FPEB	ID	INVFRM	MIP	P	PFINBTMB	RD	TD	TVR_V	WLI
			•	•					•		•			•		•				•

**Construction Upgrades**

APC	PE
•	•

**Door Options**

ALF	CG	CG.BTM	CG.TOP	DPSRR	MD	MD.BTM	MD.TOP	MFO
	•			•	•†			•

†Available only on W2439CIA and W2442CIA

**WALL END CABINET SINGLE DOOR,  
30", 33", 36", 39", or 42" HIGH,  
12" x 12"**

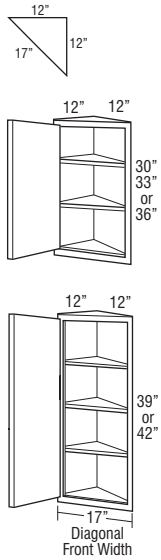

- WEC1230 L or R
- WEC1233 L or R
- WEC1236 L or R

- WEC1239 L or R\*
- WEC1242 L or R\*

- Width at wall: 12" x 12".
  - Cabinet features two unfinished back panels. Must be installed with one back panel adjacent to a cabinet of equal height with the other back panel attached to the wall.
- \*When ordered with MD, shelves will not align with mullions.

**Custom Modifications**

ADDTK	AUTH	CBO	CCO	CFNTO	CFRMO	CND	EXBK	EX	FB	FFD	FPEB	ID	INVFRM	MIP	P	PFINBTMB	RD	TD	TVR_V	WLI
			•	•	•									•		•				•

**Construction Upgrades**

APC	PE
•	

**Door Options**

ALF	CG	CG.BTM	CG.TOP	DPSRR	MD	MD.BTM	MD.TOP	MFO
	•			•	•			•



**WALL END CABINET DOUBLE DOOR,  
30", 33", 36", 39", or 42" HIGH,  
12" x 12"**

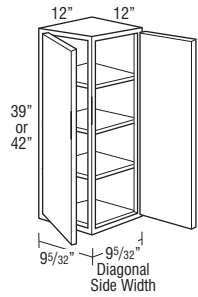
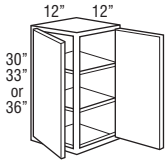
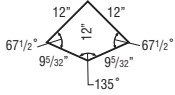

**WEC1230D**  
**WEC1233D**  
**WEC1236D**

**WEC1239D**  
**WEC1242D**

- Width at wall: 12" x 12".
- Cabinet features two unfinished back panels. Must be installed with one back panel adjacent to a cabinet of equal height with the other back panel attached to the wall.
- Decorative glass inserts are not available.

**Custom Modifications**

ADDTK	AUTH	CBO	CCO	CFNTO	CFRMO	CND	EXBK	EX	FB	FFD	FPEB	ID	INVFRM	MIP	P	PFINBTMB	RD	TD	TVR_V	WLI	
		•	•											•		•					•

**Construction Upgrades**

APC	PE
•	

**Door Options**

ALF	CG	CG.BTM	CG.TOP	DPSRR	MD	MD.BTM	MD.TOP	MFO
	•			•				•

**WALL QUARTER ROUND END SHELF,  
30", 33", 36", 39", or 42" HIGH**

**Radius Top and Bottom Panels**

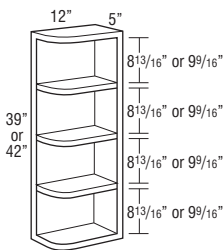
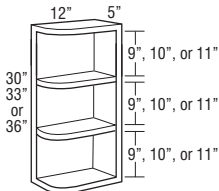
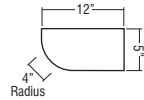

**WQRES630RT**  
**WQRES633RT**  
**WQRES636RT**

**WQRES639RT**  
**WQRES642RT**

- Units are reversible.
- Radius moulding is not available for WQRES636RT.
- Veneer on 3/4" furniture board core with matching interior.
- If ordered with Heirloom Technique, will not feature sand-through characteristics.
- Cabinet features two unfinished back panels. Must be installed with one back panel adjacent to a cabinet of equal height with the other back panel attached to the wall.

**MODIFICATIONS**

No modifications available for these products.

**Construction Upgrades**

APC	PE
•	

**WALL QUARTER ROUND END SHELF, 30", 33", 36", 39", or 42" HIGH**

Square Top and Radius Bottom Panels

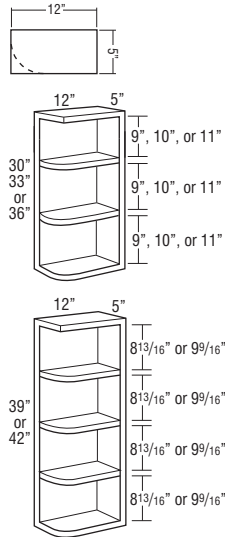

**WQRES630ST L or R**  
**WQRES633ST L or R**  
**WQRES636ST L or R**

**WQRES639ST L or R**  
**WQRES642ST L or R**

- Specify left or right. Only top panel is square. Right shown.
- Veneer on 3/4" furniture board core with matching interior.
- If ordered with Heirloom Technique, will not feature sand-through characteristics.
- Cabinet features two unfinished back panels. Must be installed with one back panel adjacent to a cabinet of equal height with the other back panel attached to the wall.

MODIFICATIONS	
No modifications available for these products.	

**Construction Upgrades**

APC	PE
•	

**WALL QUARTER ROUND END SHELF, 30", 33", 36", 39", or 42" HIGH**

Square Top and Bottom Panels

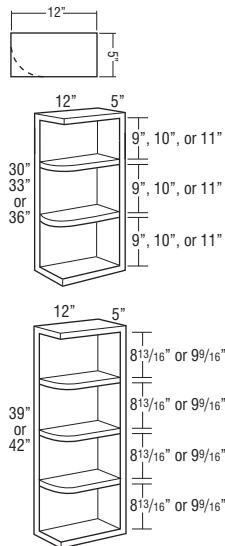

**WQRES630STSB**  
**WQRES633STSB**  
**WQRES636STSB**

**WQRES639STSB**  
**WQRES642STSB**

- Units are reversible.
- Veneer on 3/4" furniture board core with matching interior.
- If ordered with Heirloom Technique, will not feature sand-through characteristics.
- Cabinet features two unfinished back panels. Must be installed with one back panel adjacent to a cabinet of equal height with the other back panel attached to the wall.

MODIFICATIONS	
No modifications available for these products.	

**Construction Upgrades**

APC	PE
•	

**WALL QUARTER ROUND END SHELF,  
12" RADIUS, 30", 33", 36", 39", or  
42" HIGH**

**WQRES1230RT  
WQRES1233RT  
WQRES1236RT**

**Radius Top and Bottom Panels**

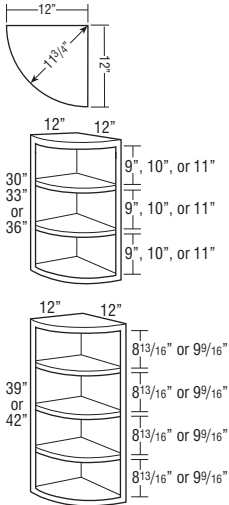

**WQRES1239RT  
WQRES1242RT**

- Veneer on 3/4" furniture board core with matching interior.
- If ordered with Heirloom Technique, will not feature sand-through characteristics.
- Cabinet features two unfinished back panels. Must be installed with one back panel adjacent to a cabinet of equal height with the other back panel attached to the wall.

MODIFICATIONS	
No modifications available for these products.	

**Construction Upgrades**

APC	PE
•	

**WALL QUARTER ROUND END SHELF,  
12" RADIUS, 30", 33", 36", 39", or  
42" HIGH**

**WQRES1230STRB  
WQRES1233STRB  
WQRES1236STRB**

**Square Top and Radius Bottom Panels**

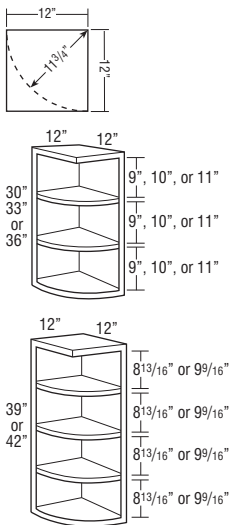

**WQRES1239STRB  
WQRES1242STRB**

- Veneer on 3/4" furniture board core with matching interior.
- If ordered with Heirloom Technique, will not feature sand-through characteristics.
- Cabinet features two unfinished back panels. Must be installed with one back panel adjacent to a cabinet of equal height with the other back panel attached to the wall.

MODIFICATIONS	
No modifications available for these products.	

**Construction Upgrades**

APC	PE
•	

**WALL MICROWAVE CABINET,  
18" or 21" HIGH**

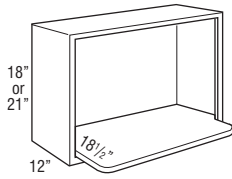

	Opening		Cabinet	
	Width	Height	Width	Height
MW2718	24"	14 1/4"	27"	18"
MW3018	27"	14 1/4"	30"	18"
MW2721	24"	17 1/4"	27"	21"
MW3021	27"	17 1/4"	30"	21"

- MW2718**
- MW3018**
- MW2721**
- MW3021**

- Includes one 3/4" shelf with six mounting screws. Microwave shelf extends beyond the front of the cabinet by 6 1/2", for a total shelf depth of 18 1/2".
- Microwave cabinet must be attached to wall stud and adjacent cabinets on both sides for support.
- Matching Interior Plywood (MIP) standard.
- When ID is ordered, shelf will not be included with cabinet.
- If ordered with Heirlooming Technique, will not feature sand-through characteristics.

**Custom Modifications**

ADDTK	AUTH	CBO	CCO	CFNTO	CFRMO	CND	EXBK	EX	FB	FFD	FPEB	ID	INVFRM	MIP	P	PFINBTMB	RD	TD	TVR_V	WLI
			•	STD		•	•	•			•	•		STD		•				

**Construction Upgrades**

APC	PE

**Door Options**

ALF	CG	CG.BTM	CG.TOP	DPSRR	MD	MD.BTM	MD.TOP	MFO

**WALL MICROWAVE DOUBLE DOOR  
CABINET, 36", 39", or 42" HIGH**

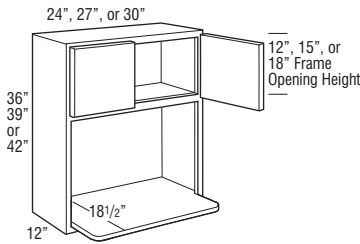

	Opening		Cabinet	
	Width	Height	Width	Height
MW2436	21"	18 3/4"	24"	36"
MW2736	24"	18 3/4"	27"	36"
MW3036	27"	18 3/4"	30"	36"
MW2439	21"	18 3/4"	24"	39"
MW2739	24"	18 3/4"	27"	39"
MW3039	27"	18 3/4"	30"	39"
MW2442	21"	18 3/4"	24"	42"
MW2742	24"	18 3/4"	27"	42"
MW3042	27"	18 3/4"	30"	42"

- MW2436**
- MW2736**
- MW3036**
- MW2439**
- MW2739**
- MW3039**
- MW2442**
- MW2742**
- MW3042**

- Includes one 3/4" shelf with six mounting screws. Microwave shelf extends beyond the front of the cabinet by 6 1/2", for a total shelf depth of 18 1/2".
- Microwave cabinet must be attached to wall stud and adjacent cabinets on both sides for support.
- Matching Interior Plywood (MIP) standard.
- When ID is ordered, shelf will not be included with cabinet.

**Custom Modifications**

ADDTK	AUTH	CBO	CCO	CFNTO	CFRMO	CND	EXBK	EX	FB	FFD	FPEB	ID	INVFRM	MIP	P	PFINBTMB	RD	TD	TVR_V	WLI
			•	•	•	•	•	•			•	•		STD		•				

**Construction Upgrades**

APC	PE

**Door Options**

ALF	CG	CG.BTM	CG.TOP	DPSRR	MD	MD.BTM	MD.TOP	MFO
	•			•				•

**WALL BUILT-IN MICROWAVE  
CABINET, 18" or 21" HIGH**

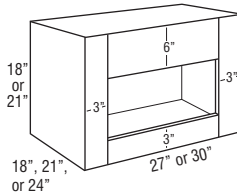

Model	Factory Opening	Maximum Cut-out
WBMW2718..	21W x 9H	25 1/2W x 15H
WBMW2721..	21W x 12H	25 1/2W x 18H
WBMW3018..	24W x 9H	28 1/2W x 15H
WBMW3021..	24W x 12H	28 1/2W x 18H

- WBMW271818**
- WBMW301818**
- WBMW272118**
- WBMW302118**
- WBMW271821**
- WBMW301821**
- WBMW272121**
- WBMW302121**
- WBMW271824**
- WBMW301824**
- WBMW272124**
- WBMW302124**

- WBMWs can be used to stack with other cabinets to create custom appliance cabinet designs.
- Microwave cabinet must be attached to wall stud and adjacent cabinets on both sides for support.
- If ordered with Heirlooming Technique, will not feature sand-through characteristics.

**Custom Modifications**

ADDTK	AUTH	CBO	CCO	CFNTO	CFRMO	CND	EXBK	EX	FB	FFD	FPEB	ID	INVFRM	MIP	P	PFINBTMB	RD	TD	TVR_V	WLI
			•	STD		•	•	•			•	•		•		•	•			•

**Construction Upgrades**

APC	PE
•	•

**Door Options**

ALF	CG	CG.BTM	CG.TOP	DPSRR	MD	MD.BTM	MD.TOP	MFO

**WALL BUILT-IN MICROWAVE  
DOUBLE DOOR CABINET, 36", 39",  
or 42" HIGH, 18" or 21" DEEP**

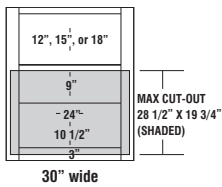
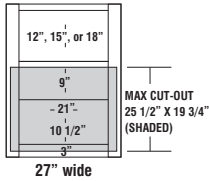
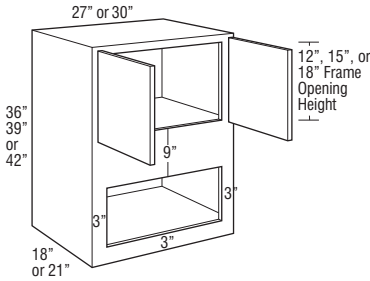

Model	Factory Opening	Maximum Cut-out
WBMW27..	21W x 10 1/2H	25 1/2W x 19 3/4H
WBMW30..	24W x 10 1/2H	28 1/2W x 19 3/4H

- WBMW273618
- WBMW303618
- WBMW273918
- WBMW303918
- WBMW274218
- WBMW304218
- WBMW273621
- WBMW303621
- WBMW273921
- WBMW303921
- WBMW274221
- WBMW304221

- Uses face mount hinges, doors have a consistent 1/4" width reveal.
- Two 1/4" fillers included, except with FPEB, AUTHL, AUTHR, and AUTHB.
- Microwave cabinet must be attached to wall stud and adjacent cabinets on both sides for support.
- All cabinets have 3" stiles on frames.

**Custom Modifications**

ADDTK	AUTH	CBO	CCO	CFNTO	CFRMO	CND	EXBK	EX	FB	FFD	FPEB	ID	INVFRM	MIP	P	PFINBTMB	RD	TD	TVR_V	WLI	
	•		•	•*			•	•	•		•	•		•			•	•			•

\*Not available on 18" deep

**Construction Upgrades**

APC	PE
•	•

**Door Options**

ALF	CG	CG.BTM	CG.TOP	DPSRR	MD	MD.BTM	MD.TOP	MFO
				•				•

**WALL APPLIANCE GARAGE DOOR,  
18" HIGH, 12" DEEP**

12", 15", 18", 21", or 24"

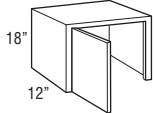

24", 27", 30", 33", or 36"

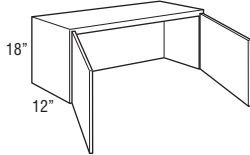

- WAGD12 L or R
- WAGD15 L or R
- WAGD18 L or R
- WAGD21 L or R
- WAGD24 L or R

- WAGD24
- WAGD27
- WAGD30
- WAGD33
- WAGD36

- Cabinet does not have floor.

**Custom Modifications**

ADDTK	AUTH	CBO	CCO	CFNTO	CFRMO	CND	EXBK	EX	FB	FFD	FPEB	ID	INVFRM	MIP	P	PFINBTMB	RD	TD	TVR_V	WLI	
	•		•	•	•		•	•	STD		•	•		•			•	•			•

**Construction Upgrades**

APC	PE
•	STD

**Door Options**

ALF	CG	CG.BTM	CG.TOP	DPSRR	MD	MD.BTM	MD.TOP	MFO
	•			•				

**WALL APPLIANCE GARAGE  
VERTICAL-LIFT DOOR,  
18" HIGH, 12" DEEP**

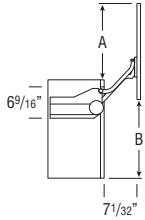
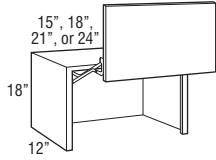

Full Overlay	
A	16 13/16"
B	17 5/16"

**WAGVLD15  
WAGVLD18  
WAGVLD21  
WAGVLD24**

- Uses standard configuration doors with vertical center panel grain. Door 19 and Door 36 have a standard vertical grain pattern. Door 33 has a standard horizontal grain pattern. See page 9 for more details.
- Decorative hardware required.
- See side view drawing for required clearances.
- Lift mechanism features a single motion for up and out movement with smart close, tension can be field adjusted.
- Lift mechanisms and mounting brackets will be visible if used with transparent textured glass.
- Lift mechanism not available for order for field installation, only available factory installed.
- Hardware extends 1" into opening on each side.
- Bottom edge not trimmable.

**Custom Modifications**

ADDTK	AUTH	CBO	CCO	CFNTO	CFRMO	CND	EXBK	EX	FB	FFD	FPEB	ID	INVFRM	MIP	P	PFINBTMB	RD	TD	TVR_V	WLI	
	•		•			•		•	•		•	•		•							•

**Construction Upgrades**

APC	PE
•	•

**Door Options**

ALF	CG	CG.BTM	CG.TOP	DPSRR	MD	MD.BTM	MD.TOP	MFO
	•			•				

**CORNER DOOR, 18" HIGH**

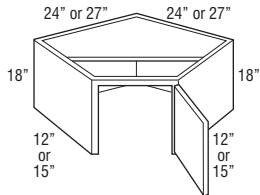

**CD2424 L or R  
CD2727 L or R**

- CD2424 L or R requires 24" x 24" corner wall space.
- CD2727 L or R requires 27" x 27" corner wall space.
- Cabinet is designed to fit beneath Diagonal Wall Cabinets.
- Cabinet has partial top and no floor.
- Full overlay styles use T4 1/2" wide doors with 38NPOHINGE to allow for proper door clearance with adjacent cabinets.

**Custom Modifications**

ADDTK	AUTH	CBO	CCO	CFNTO	CFRMO	CND	EXBK	EX	FB	FFD	FPEB	ID	INVFRM	MIP	P	PFINBTMB	RD	TD	TVR_V	WLI	
	•		•	•		•			•		•			•							•

**Construction Upgrades**

APC	PE
•	•

**Door Options**

ALF	CG	CG.BTM	CG.TOP	DPSRR	MD	MD.BTM	MD.TOP	MFO
	•			•				

**WALL BOX COLUMN PULL-OUT,  
PLAIN**

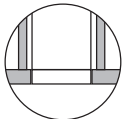
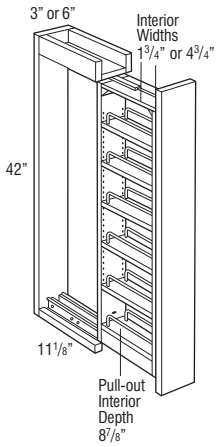
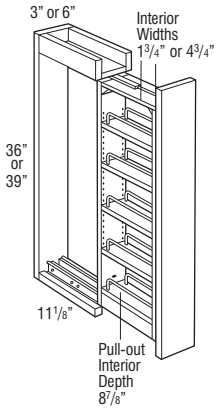
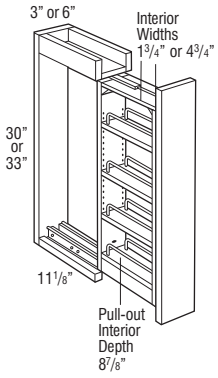

Top View

WBCPO330  
WBCPO630  
WBCPO333  
WBCPO633

WBCPO336  
WBCPO636  
WBCPO339  
WBCPO639

WBCPO342  
WBCPO642

- Recommend installation between two cabinets. Can be installed on the end of a run or adjacent to an appliance with a 3/4" thick end panel.
- All styles feature a natural finish full extension wood pull-out with adjustable shelves and chrome rail sides.
- If ordered with Heirlooming Technique, will not feature sand-through characteristics.
- In order to allow proper clearance for opening and closing, allow an additional 1/8" space between adjacent cabinet face frames. The 3" wide pull-outs require 3 1/8" space and the 6" wide pull-outs require 6 1/8" space. Spacers are included with the pull-outs to allow for proper installation.
- For full access from both sides of unit, do not install against a wall or next to deeper appliances and cabinets.

**MODIFICATIONS**

No modifications available for these products.

**Finish Techniques**

Distressing	Heirlooming
•	

**WALL BOX COLUMN PULL-OUT, OVERLAY**

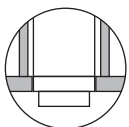
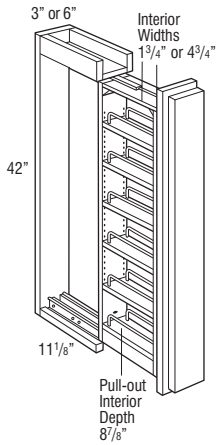
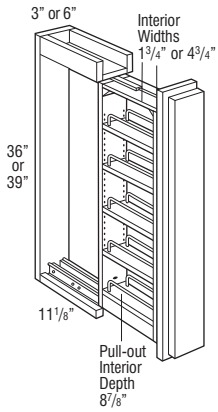
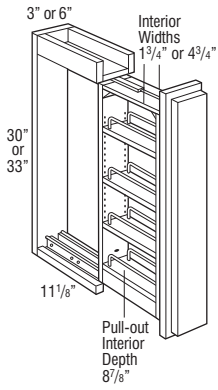

Top View

WBCP03300L  
WBCP06300L  
WBCP03330L  
WBCP06330L

WBCP03360L  
WBCP06360L  
WBCP03390L  
WBCP06390L

WBCP03420L  
WBCP06420L

- Recommend installation between two cabinets. Can be installed on the end of a run or adjacent to an appliance with a 3/4" thick end panel.
- Overlay application includes profiled full overlay filler.
- All styles feature a natural finish full extension wood pull-out with adjustable shelves and chrome rail sides.
- In order to allow proper clearance for opening and closing, allow an additional 1/8" space between adjacent cabinet face frames. The 3" wide pull-outs require 3 1/8" space and the 6" wide pull-outs require 6 1/8" space. Spacers are included with the pull-outs to allow for proper installation.
- For full access from both sides of unit, do not install against a wall or next to deeper appliances and cabinets.
- Not compatible with face mount moulding.

**MODIFICATIONS**

No modifications available for these products.

**Finish Techniques**

Distressing	Heirlooming
•	•



**WALL SPICE PULL-OUT,  
30", 33", 36", 39", or 42" HIGH**

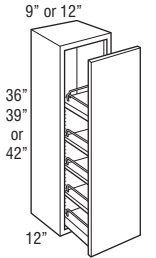
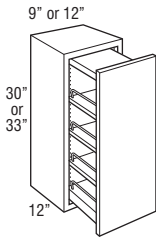

**WSP930**  
**WSP1230**  
**WSP933**  
**WSP1233**

**WSP936**  
**WSP1236**  
**WSP939**  
**WSP1239**  
**WSP942**  
**WSP1242**

- 30" and 33" high units include a natural finish, full extension wood pull-out with three adjustable shelves, one fixed shelf, and chrome finish rail sides.
- Wood plugs for top of 30" and 33" high pull-out included for field installation.
- 36" to 42" high units include a natural finish, full extension wood pull-out with three adjustable shelves, two fixed shelves, and chrome finish rail sides.
- Wire for top rail on 36" to 42" high pull-out included separately for field installation.
- For full access from both sides of unit, do not install against a wall or next to deeper appliances and cabinets.
- Pull-out does not have smart close feature.

**Custom Modifications**

ADDTK	AUTH	CBO	CCO	CFNTO	CFRMO	CND	EXBK	EX	FB	FFD	FPEB	ID	INVRM	MIP	P	PFINBTMB	RD	TD	TVR_V	WLI	
•	•	•	•		•		•	•	•		•					•					

**Construction Upgrades**

APC	PE
•	•

**Door Options**

ALF	CG	CG.BTM	CG.TOP	DPSRR	MD	MD.BTM	MD.TOP	MFO
				•				•

**WALL SHELF PULL-DOWN**

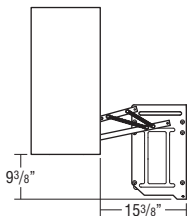
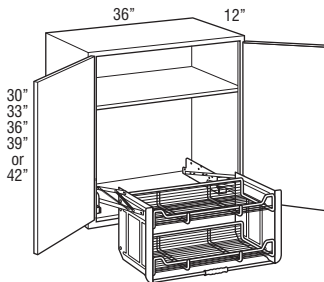
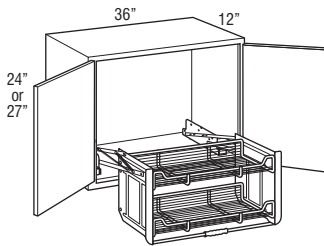

**W3624SHLFPD**  
**W3627SHLFPD**

**W3630SHLFPD**  
**W3633SHLFPD**  
**W3636SHLFPD**  
**W3639SHLFPD**  
**W3642SHLFPD**

- Shelf Pull-down dimensions: 18 11/64" high x 28 1/4" wide x 8 1/2" deep.
- Interior dimensions of pull-down trays: 28 1/4" wide x 8 1/2" deep.
- Clearance dimensions: 19 3/8" high x 15 3/8" wide.
- 30" to 42" high units will have one adjustable shelf above pull-down unit.
- Maximum Weight Capacity for Shelf Pull-down: 26 lbs.

**Custom Modifications**

ADDTK	AUTH	CBO	CCO	CFNTO	CFRMO	CND	EXBK	EX	FB	FFD	FPEB	ID	INVRM	MIP	P	PFINBTMB	RD	TD	TVR_V	WLI	
	•	•	•	•	•		•	•	•		•					•					•

**Construction Upgrades**

APC	PE
•	•

**Door Options**

ALF	CG	CG.BTM	CG.TOP	DPSRR	MD	MD.BTM	MD.TOP	MFO
				•	•†			•

†Not available on 27" high

**WALL SPICE RACK CABINET,  
30", 33", 36", 39", or 42" HIGH**

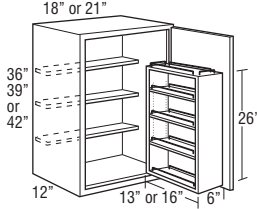
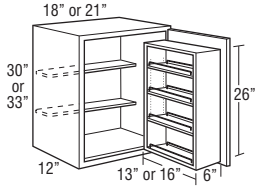

**WSR1830 L or R**  
**WSR2130 L or R**  
**WSR1833 L or R**  
**WSR2133 L or R**

**WSR1836 L or R**  
**WSR2136 L or R**  
**WSR1839 L or R**  
**WSR2139 L or R**  
**WSR1842 L or R**  
**WSR2142 L or R**

- Shelves are 4 1/2" deep.
- Field installed swing-out has three adjustable and one fixed bottom shelf with chrome finish wire rail sides.
- Dimensions: WSR18 wood insert is 26" high x 13" wide x 6" deep. WSR21 wood insert is 26" high x 16" wide x 6" deep.
- When Increased Depth (ID) is ordered, wood insert will not increase in size.
- Maximum Weight Capacity for Spice Rack Shelves: 15 lbs.

**Custom Modifications**

ADDTK	AUTH	CBO	CCO	CFNTO	CFRMO	CND	EXBK	EX	FB	FFD	FPEB	ID	INVFRM	MIP	P	PFINBTMB	RD	TD	TVR_V	WLI	
•	•	•	•	•	•	•	•	•	•	•	•	•	•	•	•	•	•	•	•	•	•

**Construction Upgrades**

APC	PE
•	•

**Door Options**

ALF	CG	CG.BTM	CG.TOP	DPSRR	MD	MD.BTM	MD.TOP	MFO
•	•	•	•	•	•	•	•	•

**WALL WINE RACK,  
15", 18", or 30" HIGH**

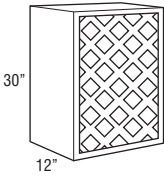
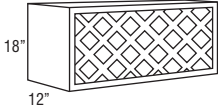
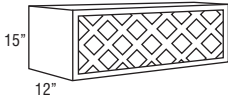

**WNR3015**  
**WNR3615**

**WNR3018**  
**WNR3618**

**WNR1530**  
**WNR1830**  
**WNR2130**

- Matching Interior Plywood (MIP) standard.
- Cabinet interior finished to match cabinet face frame.
- Solid-wood lattice work.
- Wine bottle opening 4" x 4".
- If ordered with Heirloom Technique, will not feature sand-through characteristics.

**Custom Modifications**

ADDTK	AUTH	CBO	CCO	CFNTO	CFRMO	CND	EXBK	EX	FB	FFD	FPEB	ID	INVFRM	MIP	P	PFINBTMB	RD	TD	TVR_V	WLI	
•	•	•	•	•	•	•	•	•	•	•	•	•	•	•	•	•	•	•	•	•	•

**Construction Upgrades**

APC	PE
•	•

**Door Options**

ALF	CG	CG.BTM	CG.TOP	DPSRR	MD	MD.BTM	MD.TOP	MFO
•	•	•	•	•	•	•	•	•

Model	# of Bottles
WNR3015	11
WNR3615	13
WNR3018	11
WNR3618	13
WNR1530	11
WNR1830	11
WNR2130	11

**WINE STORAGE CABINET,  
12", 15", 18", 21", or 24" HIGH**

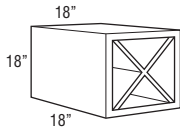
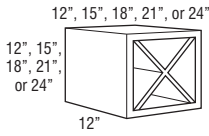

Model	# of Bottles
WSC121212	4
WSC151512	10
WSC181812	18
WSC212112	24
WSC242412	32
WSC181818	18

**WSC121212**  
**WSC151512**  
**WSC181812**  
**WSC212112**  
**WSC242412**

**WSC181818**

- Matching Interior Plywood (MIP) standard.
- Must be installed between two cabinets, between a cabinet and a wall, or mounted to a horizontal surface.
- "X" shelf configuration cannot be removed.
- If ordered with Heirloom Technique, will not feature sand-through characteristics.
- Reduced depth not recommended for safe wine bottle storage.

**Custom Modifications**

ADDTK	AUTH	CBO	CCO	CFNTO	CFRMO	CND	EXBK	EX	FB	FFD	FPEB	ID	INVFRM	MIP	P	PFINBTMB	RD	TD	TVR_V	WLI
							•				•	•*		STD		•	•			

\*ID on 12" deep models available up to 18" deep

**Construction Upgrades**

APC	PE
STD	

**Door Options**

ALF	CG	CG.BTM	CG.TOP	DPSRR	MD	MD.BTM	MD.TOP	MFO

**WALL WINE CUBBY, 24", 30", 36",  
or 42" WIDE, 6" HIGH**

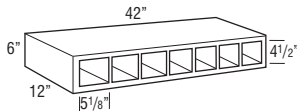
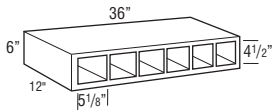
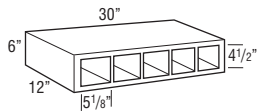
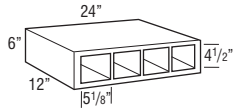

**W624** (4 openings)

**W630** (5 openings)

**W636** (6 openings)

**W642** (7 openings)

- Veneer on 3/4" furniture board core.
- Matching interior.
- Frameless construction.
- If ordered with Heirloom Technique, will not feature sand-through characteristics.
- Increased Depth only available in 3" increments.

**Custom Modifications**

ADDTK	AUTH	CBO	CCO	CFNTO	CFRMO	CND	EXBK	EX	FB	FFD	FPEB	ID	INVFRM	MIP	P	PFINBTMB	RD	TD	TVR_V	WLI
									STD			•								

**Construction Upgrades**

APC	PE

**Door Options**

ALF	CG	CG.BTM	CG.TOP	DPSRR	MD	MD.BTM	MD.TOP	MFO

**WALL ORGANIZER, 24", 30", or 36" WIDE, 6" HIGH**

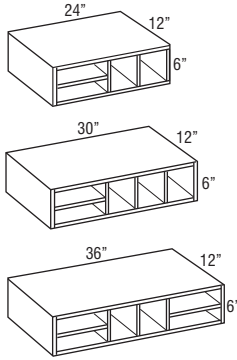

**W024**

**W030**

**W036**

- Veneer on a 3/4" furniture board core.
- Frameless construction.
- Matching interior.
- If ordered with Heirlooming Technique, will not feature sand-through characteristics.
- Increased Depth only available in 3" increments.

**Custom Modifications**

ADDTK	AUTH	CBO	CCO	CFNTO	CFRMO	CND	EXBK	EX	FB	FFD	FPEB	ID	INVFRM	MIP	P	PFINBTMB	RD	TD	TVR_V	WLI	
									STD				•								

**Construction Upgrades**

APC	PE

**Door Options**

ALF	CG	CG.BTM	CG.TOP	DPSRR	MD	MD.BTM	MD.TOP	MFO

**WALL SPICE DRAWER, 24", 30", 36", or 42" WIDE, 6" HIGH**

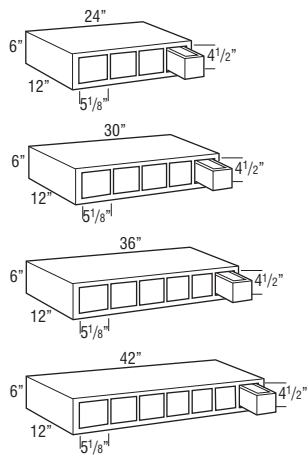

**WSD24 (4 drawers)**

**WSD30 (5 drawers)**

**WSD36 (6 drawers)**

**WSD42 (7 drawers)**

- Drawer front is unique to item and will not match profile chosen.
- All styles use standard drawer front profile except Door 15, Door 16, Door 18, Door 19, Door 26, Door 28, Door 32, Door 38, Door 41, Door 44, Door 45, Door 46, and Door 47, which use the shaker profile.
- Door 25, Door 33, Door 36, and Door 37 drawer fronts will match doors and drawer fronts.
- Veneer on 3/4" furniture board core.
- 1/2" hardwood drawer with rabbet joint.
- Horizontal application only.
- Matching interior.
- Frameless construction.
- Increased Depth only available in 3" increments.

**Custom Modifications**

ADDTK	AUTH	CBO	CCO	CFNTO	CFRMO	CND	EXBK	EX	FB	FFD	FPEB	ID	INVFRM	MIP	P	PFINBTMB	RD	TD	TVR_V	WLI	
									STD				•								

**Construction Upgrades**

APC	PE

**Door Options**

ALF	CG	CG.BTM	CG.TOP	DPSRR	MD	MD.BTM	MD.TOP	MFO

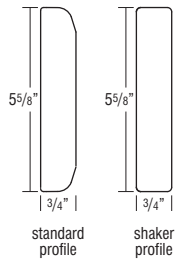

**WALL MESSAGE CENTER, 30", 33", 36", 39", or 42" HIGH, 3" DEEP**

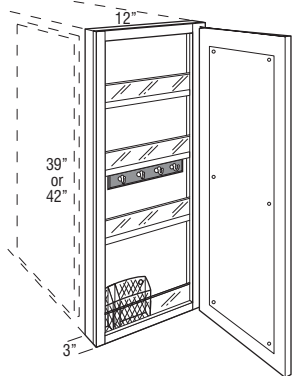
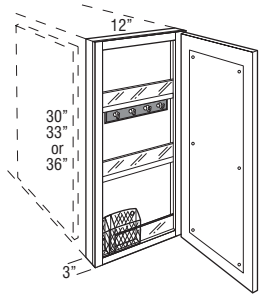

**WMC1230 L or R**  
**WMC1233 L or R**  
**WMC1236 L or R**

**WMC1239 L or R**  
**WMC1242 L or R**

- Includes magnetic whiteboard on back of door, key hooks, pencil holder, and fixed plexi-glass fronted shelves.
- WMC1230, WMC1233, and WMC1236 have 2 fixed shelves. WMC1239 and WMC1242 have 3 fixed shelves.
- Not recommended for use next to a Peninsula cabinet due to the additional 1/4" cabinet depth.
- Door will open 90° without decorative hardware.
- Cabinet should be hinged on wall side.
- For proper installation, adjacent cabinet must have FPEB or 1/4" skin applied.
- Overlay fillers can be used on side of cabinet to add a decorative touch.

**Custom Modifications**

ADDTK	AUTH	CBO	CCO	CFNT0	CFRMO	CND	EXBK	EX	FB	FFD	FPEB	ID	INVFRM	MIP	P	PFINBTMB	RD	TD	TVR_V	WLI	
		•	•								STD			•							•

**Construction Upgrades**

APC	PE
•	

**Door Options**

ALF	CG	CG.BTM	CG.TOP	DPSRR	MD	MD.BTM	MD.TOP	MFO
				•				•

**CLASSIC ARCH WOOD HOOD, 36", 42", or 48" WIDE**

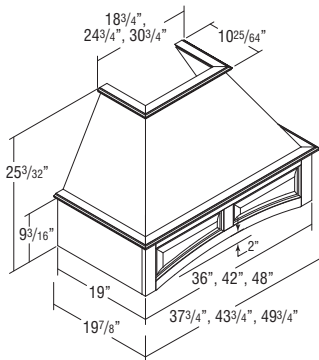

**WHA36**  
**WHA42**  
**WHA48**

- Freestanding unit (must be properly secured to wall and cannot be attached to adjacent cabinets).
- Exhaust system not included. Compatible with all blowers on page 151.
- Compatible with Classic Wood Hood Chimney (WHC\_ ), which can be trimmed. See page 145.
- Check your local building code for installation heights above the range.
- Silver metallic liner included. Assembly required.
- Arched raised panel valance front.
- Installation instructions and hardware included.
- Liner opening size: 10 1/4" deep by 19 1/2" wide.
- Wood hoods ordered in Rustic Alder and Rustic Hickory will not feature Rustic characteristics.
- No changes or cancellations will be accepted after 24 hours from acknowledgment of order.

**MODIFICATIONS**

No modifications available for these products.

**Finish Techniques**

Distressing	Heirlooming
•	•

**CLASSIC SQUARE WOOD HOOD,  
30", 36", 42", or 48" WIDE**

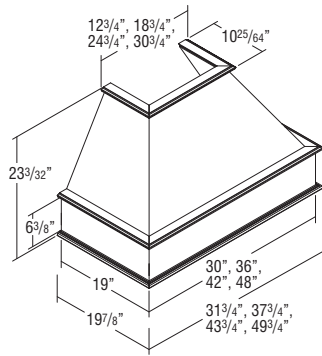

- WHS30**
- WHS36**
- WHS42**
- WHS48**

- Freestanding unit (must be properly secured to wall and cannot be attached to adjacent cabinets).
- Exhaust system not included. Compatible with all blowers on page 151.
- Compatible with Classic Wood Hood Chimney (WHC\_ ), which can be trimmed. See page 145.
- Check your local building code for installation heights above the range.
- Silver metallic liner included. Assembly required.
- Installation instructions and hardware included.
- Liner opening size: 10 1/4" deep by 19 1/2" wide.
- Wood hoods ordered in Rustic Alder and Rustic Hickory will not feature Rustic characteristics.
- No changes or cancellations will be accepted after 24 hours from acknowledgment of order.

MODIFICATIONS
No modifications available for these products.

**Finish Techniques**

Distressing	Heirlooming
•	•

**ARCH FLAT PANEL WOOD HOOD,  
30", 36", 42", or 48" WIDE**

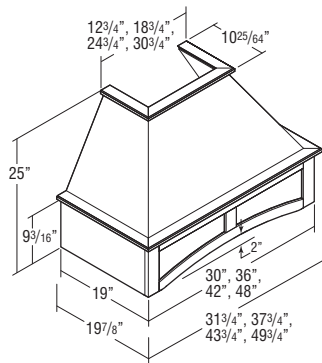

- WHAFP30**
- WHAFP36**
- WHAFP42**
- WHAFP48**

- Freestanding unit (must be properly secured to wall and cannot be attached to adjacent cabinets).
- Exhaust system not included. Compatible with all blowers on page 151.
- Compatible with Classic Wood Hood Chimney (WHC\_ ), which can be trimmed. See page 145.
- Check local building code and appliance installation specifications for clearance requirements and installation heights above the range.
- Silver metallic liner included. Assembly required.
- Installation instructions and hardware included.
- Liner opening size: 10 1/4" deep by 19 1/2" wide.
- Wood hoods ordered in Rustic Alder and Rustic Hickory will not feature Rustic characteristics.
- No changes or cancellations will be accepted after 24 hours from acknowledgment of order.

MODIFICATIONS
No modifications available for these products.

**Finish Techniques**

Distressing	Heirlooming
•	•

**SQUARE FLAT PANEL WOOD HOOD,  
30", 36", 42", or 48" WIDE**

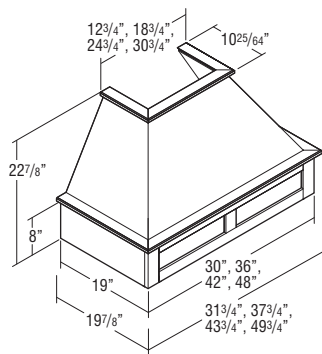

- WHSFP30**
- WHSFP36**
- WHSFP42**
- WHSFP48**

- Freestanding unit (must be properly secured to wall and cannot be attached to adjacent cabinets).
- Exhaust system not included. Compatible with all blowers on page 151.
- Compatible with Classic Wood Hood Chimney (WHC\_ ), which can be trimmed. See page 145.
- Check local building code and appliance installation specifications for clearance requirements and installation heights above the range.
- Silver metallic liner included. Assembly required.
- Installation instructions and hardware included.
- Liner opening size: 10 1/4" deep by 19 1/2" wide.
- Wood hoods ordered in Rustic Alder and Rustic Hickory will not feature Rustic characteristics.
- No changes or cancellations will be accepted after 24 hours from acknowledgment of order.

MODIFICATIONS
No modifications available for these products.

**Finish Techniques**

Distressing	Heirlooming
•	•

**CLASSIC WOOD HOOD CHIMNEY,  
23 1/2" HIGH**

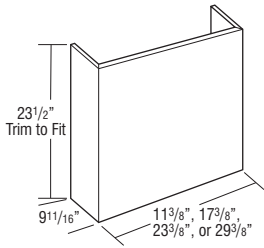

**WHC30  
WHC36  
WHC42  
WHC48**

- 3/4" thick plywood.
- Trimmable.
- If trimmed, moulding is recommended to conceal any cut marks.
- Optional accessory for Classic Arch Wood Hood (WHA), Classic Square Wood Hood (WHS), Arch Flat Panel Wood Hood (WHAFP), and Square Flat Panel Wood Hood (WHSFP).
- Wood hoods ordered in Rustic Alder and Rustic Hickory will not feature Rustic characteristics.
- No changes or cancellations will be accepted after 24 hours from acknowledgment of order.

MODIFICATIONS
No modifications available for these products.

**Finish Techniques**

Distressing	Heirlooming
•	•

**LINEAR TAPERED WOOD HOOD,  
30", 36", or 42" WIDE**

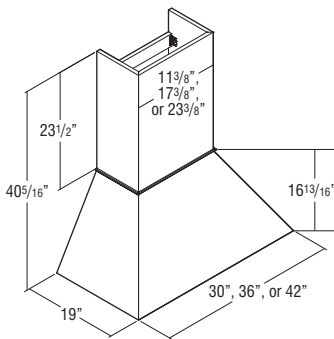

**JWHL30  
JWHL36  
JWHL42**

- Freestanding unit (must be properly secured to wall and cannot be attached to adjacent cabinets).
- Exhaust system not included. Compatible with all blowers on page 151.
- Chimney included and can be trimmed.
- Check your local building code for installation heights above the range.
- Silver metallic liner included. Assembly required.
- Installation instructions and hardware included.
- Liner opening size: 10 1/4" deep by 19 1/2" wide.
- Wood hoods ordered in Rustic Alder and Rustic Hickory will not feature Rustic characteristics.
- Available in glaze finishes, but wood hood design does not provide detail for glaze hang-up.
- No changes or cancellations will be accepted after 24 hours from acknowledgment of order.

MODIFICATIONS
No modifications available for these products.

**SHIPLAP STRAIGHT WOOD HOOD,  
36", 42", or 48" WIDE**

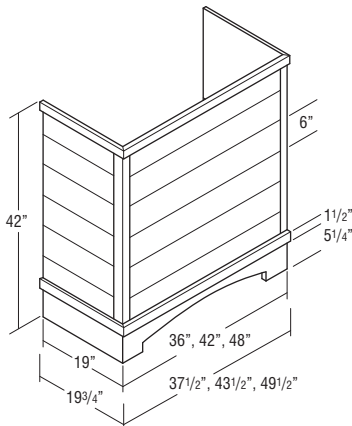

**JWHSIPSTR36  
JWHSIPSTR42  
JWHSIPSTR48**

- Freestanding unit (must be properly secured to wall and cannot be attached to adjacent cabinets).
- Constructed of 3/4" thick grooved plywood creating a shiplap appearance.
- Trimmable. If trimmed, moulding is recommended to conceal any cut marks.
- Exhaust system not included. Compatible with all blowers on page 151.
- Check local building code and appliance installation specifications for clearance requirements and installation heights above the range.
- Silver metallic liner included. Assembly required.
- Installation instructions and hardware included.
- Liner opening size: 10 1/4" deep by 19 1/2" wide.
- Wood hoods ordered in Rustic Alder will not feature Rustic characteristics.
- Not available in Rustic Hickory.
- No changes or cancellations will be accepted after 24 hours from acknowledgment of order.

MODIFICATIONS
No modifications available for these products.

**Finish Techniques**

Distressing	Heirlooming
•	•

**SHIPLAP STRAIGHT WOOD HOOD with CORBELS, 36", 42", or 48" WIDE**

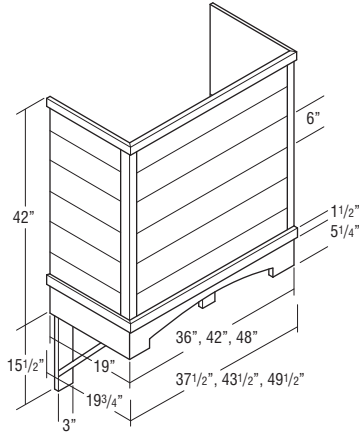

**JWHSHPSTRCB36  
JWHSHPSTRCB42  
JWHSHPSTRCB48**

- Includes a pair of decorative corbels.
- Freestanding unit (must be properly secured to wall and cannot be attached to adjacent cabinets).
- Constructed of 3/4" thick grooved plywood creating a shiplap appearance.
- Trimable. If trimmed, moulding is recommended to conceal any cut marks.
- Exhaust system not included. Compatible with all blowers on page 151.
- Check local building code and appliance installation specifications for clearance requirements (including corbels) and installation heights above the range.
- Silver metallic liner included. Assembly required.
- Installation instructions and hardware included.
- Liner opening size: 10 1/4" deep by 19 1/2" wide.
- Wood hoods ordered in Rustic Alder will not feature Rustic characteristics.
- Not available in Rustic Hickory.
- No changes or cancellations will be accepted after 24 hours from acknowledgment of order.

MODIFICATIONS
No modifications available for these products.

**Finish Techniques**

Distressing	Heirlooming
•	•

**SHIPLAP TAPERED WOOD HOOD, 30", 36", 42", or 48" WIDE**

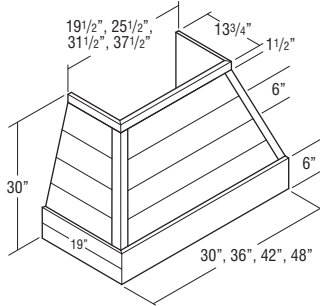

**JWHSIPT30  
JWHSIPT36  
JWHSIPT42  
JWHSIPT48**

- Freestanding unit (must be properly secured to wall and cannot be attached to adjacent cabinets).
- Constructed of 3/4" thick grooved plywood creating a shiplap appearance.
- Exhaust system not included. Compatible with all blowers on page 151.
- Compatible with Shiplap Wood Hood Chimney (JWHSHPCH\_ ), which can be trimmed. See page 147.
- Check local building code and appliance installation specifications for clearance requirements and installation heights above the range.
- Silver metallic liner included. Assembly required.
- Installation instructions and hardware included.
- Liner opening size: 10 1/4" deep by 19 1/2" wide.
- Wood hoods ordered in Rustic Alder will not feature Rustic characteristics.
- Not available in Rustic Hickory.
- No changes or cancellations will be accepted after 24 hours from acknowledgment of order.

MODIFICATIONS
No modifications available for these products.

**Finish Techniques**

Distressing	Heirlooming
•	•

**SHIPLAP TAPERED WOOD HOOD with CORBELS, 36", 42", or 48" WIDE**

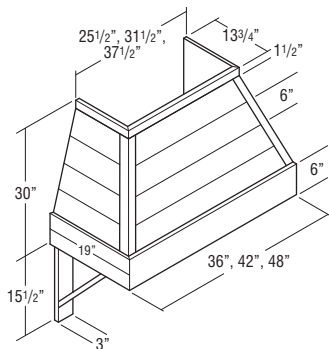

**JWHSIPTCB36  
JWHSIPTCB42  
JWHSIPTCB48**

- Includes a pair of decorative corbels.
- Freestanding unit (must be properly secured to wall and cannot be attached to adjacent cabinets).
- Constructed of 3/4" thick grooved plywood creating a shiplap appearance.
- Exhaust system not included. Compatible with all blowers on page 151.
- Compatible with Shiplap Wood Hood Chimney (JWHSHPCH\_ ), which can be trimmed. See page 147.
- Check local building code and appliance installation specifications for clearance requirements (including corbels) and installation heights above the range.
- Silver metallic liner included. Assembly required.
- Installation instructions and hardware included.
- Liner opening size: 10 1/4" deep by 19 1/2" wide.
- Wood hoods ordered in Rustic Alder will not feature Rustic characteristics.
- Not available in Rustic Hickory.
- No changes or cancellations will be accepted after 24 hours from acknowledgment of order.

MODIFICATIONS
No modifications available for these products.

**Finish Techniques**

Distressing	Heirlooming
•	•



**SHIPLAP WOOD HOOD CHIMNEY,  
24 3/4" HIGH**

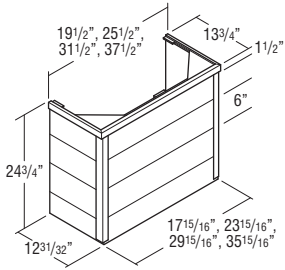

**JWHSHPCH30  
JWHSHPCH36  
JWHSHPCH42  
JWHSHPCH48**

- Constructed of 3/4" thick grooved plywood creating a shiplap appearance.
- Trimmable. If trimmed, moulding is recommended to conceal any cut marks.
- Optional accessory for Shiplap Tapered Wood Hoods (JWHSIPT\_\_ and JWHSIPTCB\_\_) for an installed height of 54".
- Wood hoods ordered in Rustic Alder will not feature Rustic characteristics.
- Not available in Rustic Hickory.
- No changes or cancellations will be accepted after 24 hours from acknowledgment of order.

MODIFICATIONS
No modifications available for these products.

**Finish Techniques**

Distressing	Heirlooming
•	•

**SIMPLE TAPERED WOOD HOOD,  
30", 36", 42", or 48" WIDE**

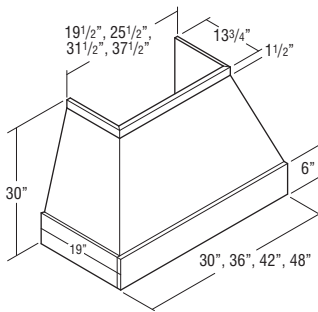

**WHSMT30  
WHSMT36  
WHSMT42  
WHSMT48**

- Freestanding unit (must be properly secured to wall and cannot be attached to adjacent cabinets).
- Exhaust system not included. Compatible with all blowers on page 151.
- Compatible with Simple Wood Hood Chimney (WHSMT\_\_), which can be trimmed. See page 148.
- Check local building code and appliance installation specifications for clearance requirements and installation heights above the range.
- Silver metallic liner included. Assembly required.
- Installation instructions and hardware included.
- Liner opening size: 10 1/4" deep by 19 1/2" wide.
- Wood hoods ordered in Rustic Alder will not feature Rustic characteristics.
- Not available in Rustic Hickory.
- No changes or cancellations will be accepted after 24 hours from acknowledgment of order.

MODIFICATIONS
No modifications available for these products.

**Finish Techniques**

Distressing	Heirlooming
•	•

**SIMPLE TAPERED WOOD HOOD  
with CORBELS, 36", 42", or  
48" WIDE**

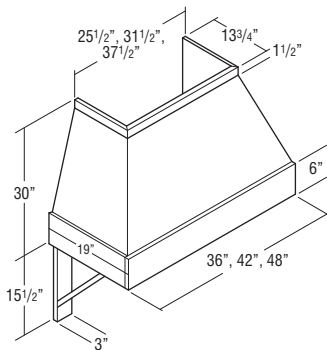

**WHSMTCB36  
WHSMTCB42  
WHSMTCB48**

- Includes a pair of decorative corbels.
- Freestanding unit (must be properly secured to wall and cannot be attached to adjacent cabinets).
- Exhaust system not included. Compatible with all blowers on page 151.
- Compatible with Simple Wood Hood Chimney (WHSMT\_\_), which can be trimmed. See page 148.
- Check local building code and appliance installation specifications for clearance requirements (including corbels) and installation heights above the range.
- Silver metallic liner included. Assembly required.
- Installation instructions and hardware included.
- Liner opening size: 10 1/4" deep by 19 1/2" wide.
- Wood hoods ordered in Rustic Alder will not feature Rustic characteristics.
- Not available in Rustic Hickory.
- No changes or cancellations will be accepted after 24 hours from acknowledgment of order.

MODIFICATIONS
No modifications available for these products.

**Finish Techniques**

Distressing	Heirlooming
•	•

**SIMPLE WOOD HOOD CHIMNEY,  
24 3/4" HIGH**

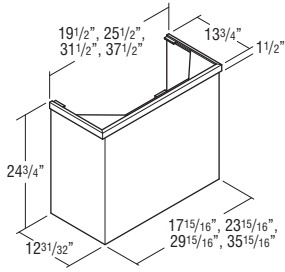

**WHSMC30**  
**WHSMC36**  
**WHSMC42**  
**WHSMC48**

- Trimmable. If trimmed, moulding is recommended to conceal any cut marks.
- Optional accessory for Simple Tapered Wood Hoods (WHSMT\_ \_ and WHSMTCB\_ \_) for an installed height of 54".
- Wood hoods ordered in Rustic Alder will not feature Rustic characteristics.
- Not available in Rustic Hickory.
- No changes or cancellations will be accepted after 24 hours from acknowledgment of order.

MODIFICATIONS	
No modifications available for these products.	

**Finish Techniques**

Distressing	Heirlooming
•	•

**CANOPY ARCH WOOD HOOD,  
30" or 36" WIDE, 24" HIGH**

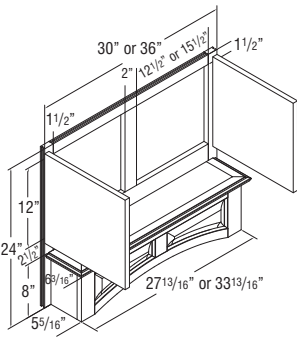

**WHCA30**  
**WHCA36**

- Install Wood Hoods between adjacent cabinets.
- Doors matching the style ordered will be installed on hood.
- Exhaust system not included. Compatible with all blowers on page 151.
- Check your local building code for installation heights above the range.
- Silver metallic liner included. Assembly required. Interior bottom section is finished below liner. Liner is not arched.
- Installation instructions and hardware included.
- Liner opening size: 10 1/4" deep by 19 1/2" wide.
- When ordered in Rustic Alder or Rustic Hickory, only the doors will have Rustic characteristics.
- Arched raised panel valance front.
- No changes or cancellations will be accepted after 24 hours from acknowledgment of order.

MODIFICATIONS	
No modifications available for these products.	

**Door Options**

ALF	CG	CG.BTM	CG.TOP	DPSRR	MD	MD.BTM	MD.TOP	MFO
								•

**Finish Techniques**

Distressing	Heirlooming
•	•

**CANOPY ARCH WOOD HOOD,  
30" or 36" WIDE, 30" HIGH**

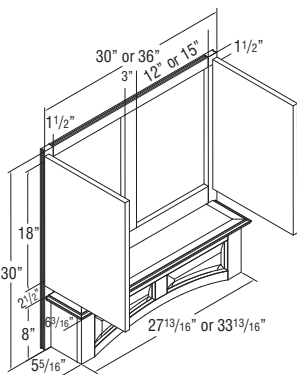

**JWHCA3030**  
**JWHCA3630**

- Install Wood Hoods between adjacent cabinets.
- Doors matching the style ordered will be installed on hood.
- Exhaust system not included. Compatible with all blowers on page 151.
- Check your local building code for installation heights above the range.
- Silver metallic liner included. Assembly required. Interior bottom section is finished below liner. Liner is not arched.
- Installation instructions and hardware included.
- Liner opening size: 10 1/4" deep by 19 1/2" wide.
- When ordered in Rustic Alder or Rustic Hickory, only the doors will have Rustic characteristics.
- Arched raised panel valance front.
- No changes or cancellations will be accepted after 24 hours from acknowledgment of order.

MODIFICATIONS	
No modifications available for these products.	

**Door Options**

ALF	CG	CG.BTM	CG.TOP	DPSRR	MD	MD.BTM	MD.TOP	MFO
								•

**Finish Techniques**

Distressing	Heirlooming
•	•

**CANOPY SQUARE WOOD HOOD,  
30" or 36" WIDE, 24" HIGH**

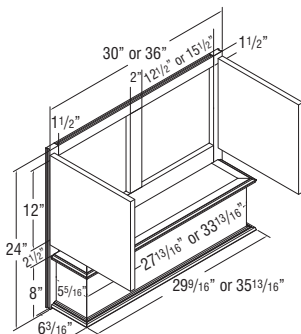

**WHCS30  
WHCS36**

- Install Wood Hoods between adjacent cabinets.
- Doors matching the style ordered will be installed on hood.
- Exhaust system not included. Compatible with all blowers on page 151.
- Check your local building code for installation heights above the range.
- Silver metallic liner included. Assembly required. Interior bottom section is finished below liner.
- Installation instructions and hardware included.
- Liner opening size: 10 1/4" deep by 19 1/2" wide.
- When ordered in Rustic Alder or Rustic Hickory, only the doors will have Rustic characteristics.
- No changes or cancellations will be accepted after 24 hours from acknowledgment of order.

MODIFICATIONS
No modifications available for these products.

**Door Options**

ALF	CG	CG.BTM	CG.TOP	DPSRR	MD	MD.BTM	MD.TOP	MFO
								•

**Finish Techniques**

Distressing	Heirlooming
•	•

**CANOPY SQUARE WOOD HOOD,  
30" or 36" WIDE, 30" HIGH**

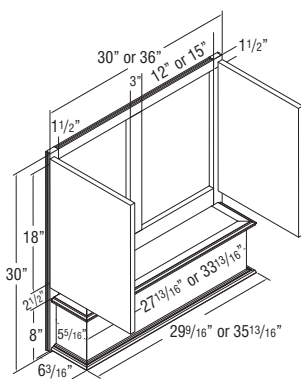

**JWHCS3030  
JWHCS3630**

- Install Wood Hoods between adjacent cabinets.
- Doors matching the style ordered will be installed on hood.
- Exhaust system not included. Compatible with all blowers on page 151.
- Check your local building code for installation heights above the range.
- Silver metallic liner included. Assembly required. Interior bottom section is finished below liner.
- Installation instructions and hardware included.
- Liner opening size: 10 1/4" deep by 19 1/2" wide.
- When ordered in Rustic Alder or Rustic Hickory, only the doors will have Rustic characteristics.
- No changes or cancellations will be accepted after 24 hours from acknowledgment of order.

MODIFICATIONS
No modifications available for these products.

**Door Options**

ALF	CG	CG.BTM	CG.TOP	DPSRR	MD	MD.BTM	MD.TOP	MFO
								•

**Finish Techniques**

Distressing	Heirlooming
•	•

**STRAIGHT BATTEN WOOD HOOD,  
30" or 36" WIDE,  
24" or 30" HIGH**

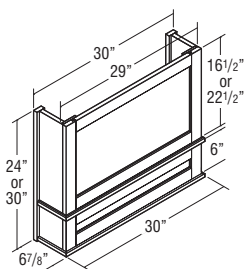

**WHSBATTEN3024  
WHSBATTEN3030**

**WHSBATTEN3624  
WHSBATTEN3630**



- Install between adjacent cabinets.
- Exhaust system not included. Compatible with all blowers on page 151.
- Check local building code and appliance installation specifications for clearance requirements and installation heights above the range.
- Silver metallic liner included. Assembly required.
- Installation instructions and hardware included.
- Liner opening size: 10 1/4" deep by 19 1/2" wide.
- End rails, side stiles, and center stiles are 2 1/4" wide with a shaker profile.
- Grain runs vertical on center panels in upper section and horizontal on center panel in lower section.
- Wood hoods ordered in Rustic Alder and Rustic Hickory will not feature Rustic characteristics.
- No changes or cancellations will be accepted after 24 hours from acknowledgment of order.

MODIFICATIONS
No modifications available for these products.

**Finish Techniques**

Distressing	Heirlooming
•	•

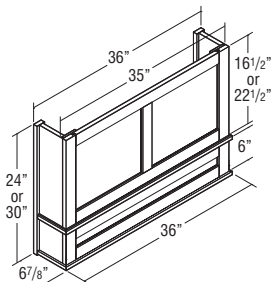

**STRAIGHT BATTEN WOOD HOOD,  
30", 36", or 42" WIDE, 36" HIGH**

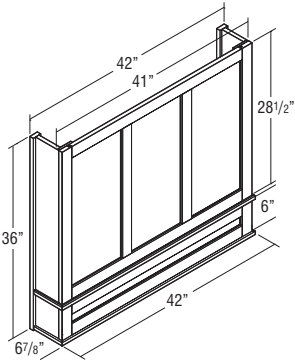
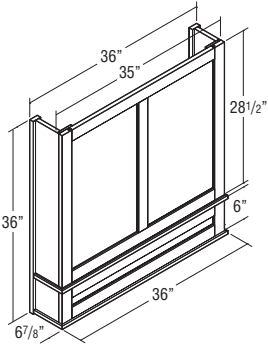
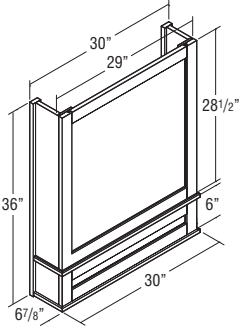

**WHSBATTEN3036**

**WHSBATTEN3636**

**WHSBATTEN4236**

- Install between adjacent cabinets.
- Exhaust system not included. Compatible with all blowers on page 151.
- Check local building code and appliance installation specifications for clearance requirements and installation heights above the range.
- Silver metallic liner included. Assembly required.
- Installation instructions and hardware included.
- Liner opening size: 10 1/4" deep by 19 1/2" wide.
- End rails, side stiles, and center stiles are 2 1/4" wide with a shaker profile.
- Grain runs vertical on center panels in upper section and horizontal on center panel in lower section.
- Wood hoods ordered in Rustic Alder and Rustic Hickory will not feature Rustic characteristics.
- No changes or cancellations will be accepted after 24 hours from acknowledgment of order.

MODIFICATIONS
No modifications available for these products.

**Finish Techniques**

Distressing	Heirlooming
•	•

**TAPERED WOOD HOOD,  
30" or 36" WIDE, 24" HIGH**

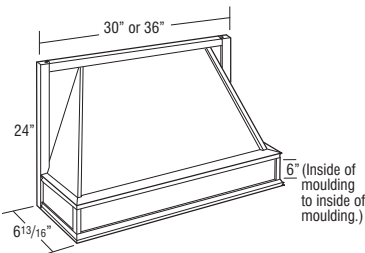

**TWH30**

**TWH36FW**

- Install Wood Hood between adjacent cabinets.
- Exhaust system not included. Compatible with all blowers on page 151.
- Check your local building code for installation heights above the range.
- Tapered design.
- Liner opening size: 10 1/4" deep x 19 1/2" wide.
- Silver metallic liner included, not available for order separately.
- Wood hoods ordered in Rustic Alder and Rustic Hickory will not feature Rustic characteristics.
- No changes or cancellations will be accepted after 24 hours from acknowledgment of order.

MODIFICATIONS
No modifications available for these products.

**Finish Techniques**

Distressing	Heirlooming
•	

## WOOD HOOD BLOWER, 1100 CFM

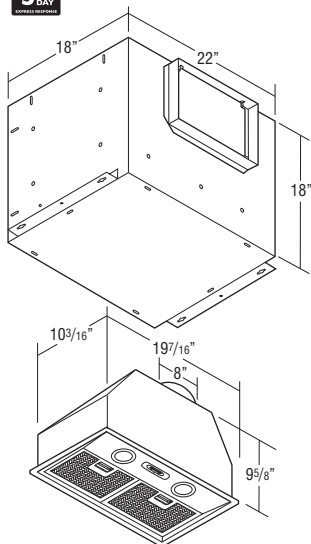

### BLOWER1100

- 1100 CFM.
- One year warranty.
- Ventilator housing unit features stainless steel finish.
- Two 50 watt (120 volt) halogen lamps included.
- Satellite blower installs remotely in the interior of the home (i.e., unfinished attic area.)
- Designed to work independently from internal blowers.
- Installation instructions, warranty, and repair information included.
- External ventilation required.
- Professional installation required.
- Compatible with all Wood Hoods and Hearths.
- Includes two in-line transitions (8" x 12" to 10" round).
- Includes two removable dishwasher safe grease filters.
- Designed for use in applications up to 110,000 BTUs.

#### MODIFICATIONS

No modifications available for these products.

## NEW WOOD HOOD BLOWER, 600 CFM

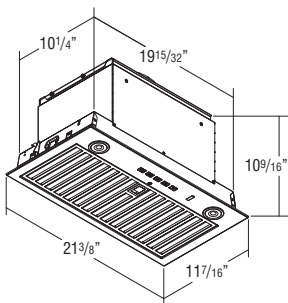

### BLOWER600

- 600 CFM.
- Two 3 watt (300+ Lumens, 3 settings) LED lights included.
- Installation instructions and repair information included.
- Stainless Steel finish.
- Four speed push button control.
- Includes removable dishwasher safe grease filter.
- WIFI Enabled, Auto-Sensing, and Heat Sentry technology included.
- Sound rating is 9.5 sones on highest setting.
- Vertical ducting requires either 6" or 8" diameter vent, or 3 1/4" x 10" vent. Horizontal ducting requires 3 1/4" x 10" vent.
- 1 year warranty.
- Compatible with all Wood Hoods and Hearths.

#### MODIFICATIONS

No modifications available for these products.

## NEW WOOD HOOD BLOWER, 400 CFM

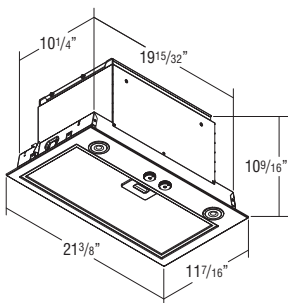

### BLOWER400

- 400 CFM, Energy Star rated.
- Two 2.8 watt (250+ Lumens) LED lights included.
- Installation instructions, warranty, and repair information included.
- Stainless Steel finish.
- Three speed rotary switch control.
- Includes removable dishwasher safe grease filter.
- Heat Sentry technology included.
- Sound rating is 7.0 sones on highest setting.
- Vertical ducting requires 7" diameter vent.
- 1 year warranty.
- Compatible with all Wood Hoods and Hearths.

#### MODIFICATIONS

No modifications available for these products.

## NEW WOOD HOOD BLOWER, 250 CFM

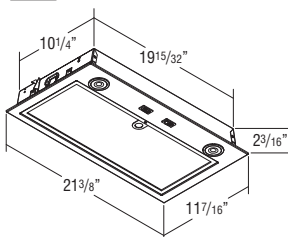

### BLOWER250

- 250 CFM.
- Two 2.8 watt (250+ Lumens) LED lights included.
- Installation instructions and repair information included.
- Stainless Steel finish.
- Two speed rocker switch control.
- Includes removable dishwasher safe grease filter.
- Sound rating is 8.0 sones on highest setting.
- Vertical ducting requires 7" diameter vent.
- 1 year warranty.
- Compatible with all Wood Hoods and Hearths.

#### MODIFICATIONS

No modifications available for these products.

**WOOD HOOD INTERIOR  
DUCTWORK CONVERSION KIT**

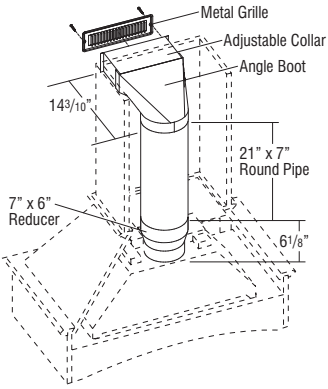

**CONVERSION**

**FILTERCHAR**

**FILTER250/390**

**FILTER500**

- CONVERSION includes: (1) 21" x 7" round pipe, (1) adjustable collar, (1) white metal soffit grille (11 3/8" x 3 5/8"), (1) angle boot, (1) 7" x 6" reducer, filter, and installation instructions.
- CONVERSION is compatible with BLOWER250, BLOWER400, and BLOWER600.
- FILTERCHAR is a replacement charcoal filter used to provide proper filtration for air recirculation when a conversion kit is used. The filter attaches to the inside of the removable mesh metal filter in the blower.
- FILTER250/390 and FILTER500 are for use with previous blower units only. FILTER250/390 is required when CONVERSION is used with TWHBLOWER250/TWHBLOWER390. FILTER500 is required when CONVERSION is used with BLOWER500.

**MODIFICATIONS**

No modifications available for these products.

**HEARTH (FLOATING), 36" HIGH, 21" DEEP**

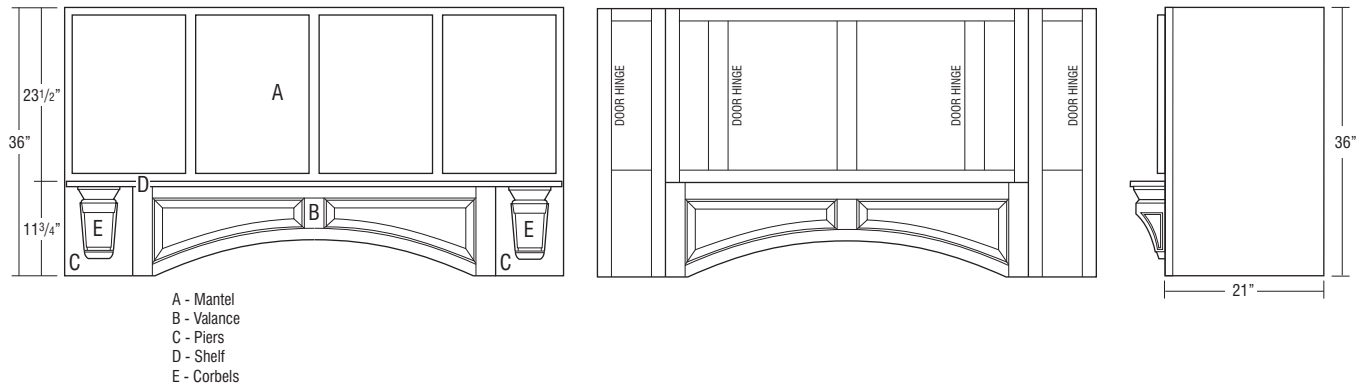

- Cabinets must be fully supported by screws installed in a structural member in the ceiling or soffit, and into adjacent cabinets or tall panels.

		Hearth Width			
		48"	54"	60"	66"
<b>36" High</b>	Pier (left)	HP93621	HP93621	HP93621	HP93621
	Pier (right)	HP93621	HP93621	HP93621	HP93621
	Mantel	HM3023.5	HM3623.5	HM4223.5	HM4823.5
	Valance	JRPV30 or JRCPV30	JRPV36 or JRCPV36	JRPV42 or JRCPV42	JRPV48 or JRCPV48
	Corbel (2 Qty)	CORBELMIS9	CORBELMIS9	CORBELMIS9	CORBELMIS9
	Shelf	HS48	HS54	HS60	HS66
	Hood Liner	HL30	HL36	HL42	HL48
	Blower	All blowers are compatible			

**HEARTH PIER, 9" WIDE, 36" HIGH**

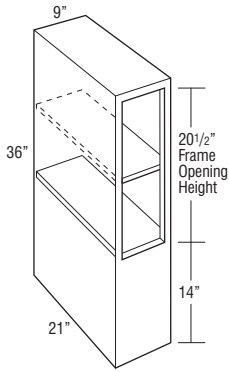

**HP93621**

- Matching Interior Plywood (MIP) standard.
- Designed for use with a floating hearth application.
- Not available in Rustic Hickory.
- Recommended for use with 24" high Mantel and 9" high Corbels.

**Custom Modifications**

ADDTK	AUTH	CBO	CCO	CFNTO	CFRMO	CND	EXBK	EX	FB	FFD	FPEB	ID	INVFRM	MIP	P	PFINBTMB	RD	TD	TVR_V	WLI
			STD									STD			STD					

**Construction Upgrades**

APC	PE

**Door Options**

ALF	CG	CG.BTM	CG.TOP	DPSRR	MD	MD.BTM	MD.TOP	MFO

**HEARTH MANTEL, 23 1/2" HIGH**

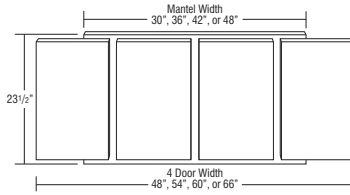

**HM3023.5**

**HM3623.5**

**HM4223.5**

**HM4823.5**

- Recommended for use with 36" high Hearth Piers and same width Raised or Recessed Panel Arched Valance (see page 153).
- Not available in Rustic Hickory.
- Doors for Hearth Mantel are included. Field installation required for attachment of outer doors to Hearth Piers.

**MODIFICATIONS**

No modifications available for these products.

**Door Options**

ALF	CG	CG.BTM	CG.TOP	DPSRR	MD	MD.BTM	MD.TOP	MFO

**Finish Techniques**

Distressing	Heirlooming

**HEARTH SHELF, 4 1/2" DEEP**

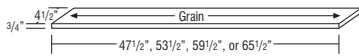

**HS48**

**HS54**

**HS60**

**HS66**

- Shelves will install on top of corbels and will slightly overlay the Raised or Recessed Panel Arched Valance.
- Shelf width should match the overall hearth width (pier width + Mantel/valance width).
- Actual shelf width is 1/2" shorter than the dimension in the product code.
- Shelf finished on one long edge, two short edges, top, and bottom.
- Not available in Rustic Hickory.
- If ordered with Heirlooming Technique, will not feature sand-through characteristics.

**MODIFICATIONS**

No modifications available for these products.

**HEARTH LINER**

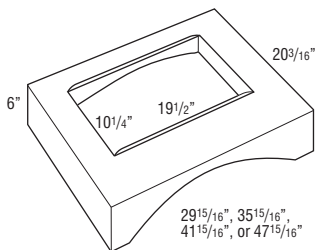

**HL30**

**HL36**

**HL42**

**HL48**

- Liner is metallic silver.
- Compatible with all blowers.
- Mounts to wall and adjoining cabinets.
- Recommended for use with Raised or Recessed Panel Arched Valance.

**MODIFICATIONS**

No modifications available for these products.



**BASE CABINET NOMENCLATURE**

All Base Cabinets are 34 1/2" high and 24" deep unless otherwise noted.



**TOEKICKS**

Base Cabinets are shipped with an unfinished toekick. Finished toekicks in matching wood veneer or laminate must be ordered separately and field installed.

**MODIFICATIONS GRID KEY**

- Available
- STD Standard on these cabinets
- 5 Day Express Response Item

**CUSTOM MODIFICATIONS**

Mod.	Description	Mod.	Description	Mod.	Description
AUTHB	Authentic Ends - Both	EXBKR	End Extended Back - Right	MIP	Matching Interior Plywood
AUTHL	Authentic End - Left	EXL	Extended Stile - Left	P	Peninsula
AUTHR	Authentic End - Right	EXR	Extended Stile - Right	PTOWB	Push to Open Wastebasket
CBO	Cabinet Box Only	FB	Flush Ends	RD	Reduced Depth
CCO	Cabinet Case Only	FD	Full Depth Shelf	RECTKALL	Recessed Island Toekick
CFNTO	Cabinet Front Only	FFDL	Face Frame and Door on End - Left	RECTKBK	Recessed Toekick - Back
CFP	Cabinet False Panel	FFDR	Face Frame and Door on End - Right	RECTKL	Recessed Toekick - Left
CFRMO	Cabinet Frame Only	FPEB	Furniture Finished Plywood Ends	RECTKR	Recessed Toekick - Right
CMAT	CabMat™	FTK	Flush Toekick	RT	Installed Roll Tray
CND	Cabinet with No Door, with Drawer	FTKAV	Flush Toekick Arch	SCPDRW	Scooped Drawer
DRT	Deep Roll Tray	FTKFV	Flush Toekick Furniture	TD	Tray Dividers
DRWPWR	PowerGlide™ Compact Drawer Outlet	ID	Increased Depth	TOTSSS	Tilt-out Tray, Stainless Steel Slim
DRWSEC	Biometric Secured Drawer	INVFRM	Inverted Frame	TVRAV	Valance Top Rail, Arch
DRWTK	Toekick Drawer	LTI	Light Installed Battery Strip	TVRFV	Valance Top Rail, Furniture
EXBKL	End Extended Back - Left			TVRVV	Valance Top Rail, Straight
				VTK	Void Toekick
				WLI	White Laminate Interior

**CONSTRUCTION UPGRADES**

Mod.	Description
APC	All-plywood Construction
ET	EasyTrax™
PE	Plywood Ends

**DOOR OPTIONS**

Mod.	Description
DPSRR	Door Panel - Solid Reverse Raised

**BASE SINGLE DOOR**

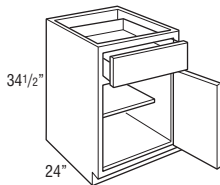

- B9 L or R**
- B12 L or R**
- B15 L or R**
- B18 L or R**
- B21 L or R**
- B24 L or R**

- Adjustable 15" deep shelves.

**Custom Modifications**

AUTH	CBO	CCO	CFNTO	CFP	CFRMO	CMAT	CND	DRT	DRWPWR	DRWSEC	DRWTK	EXBKL	EX	FB	FD	FFD	FPEB	FTK	FTK_V	ID	INVFRM	LTI	MIP	P	PTOWB	RD	RECTK	RT	SCPDRW	TD	TOTSSS	TVR_V	VTK	WLI
•	•	•	•	•	•	•	•	•	•*	•*	•*	•	•	•	•	•	•	•	•	•	•	•	•	•	•	•	•	•	•	•	•	•	•	•

\*Not available on 9", 12", and 15" wide    \*Not available on 9" and 12" wide    ▲Not available on 9" wide    †Not available on 9", 12", 15", and 18" wide

**Construction Upgrades**

APC	ET	PE
•	•	•

**Door Options**

DPSRR
•

**BASE DOUBLE DOOR**

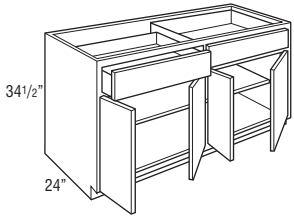
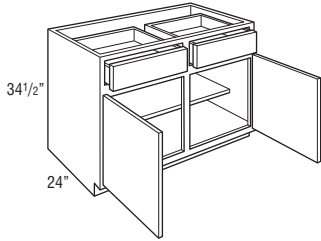
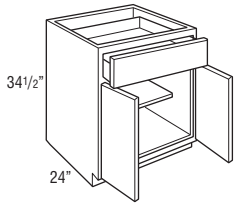

- B24**
- B27**
- B30**
- B33**
- B36**
- B39**
- B42**
- B45**
- B48CS**
- B48**

- Adjustable 15" deep shelves.

**Custom Modifications**

AUTH	CBO	CCO	CFNTO	CFP	CFRMO	CMAT	CND	DRT	DRWPWR	DRWSEC	DRWTK	EXBK	EX	FB	FD	FFD	FPEB	FTK	FTK_V	ID	INVFRM	LTI	MIP	P	PTOWB	RD	RECTK	RT	SCPDRW	TD	TOTSSS	TVR_V	VTK	WLI	
•	•	•	•	•	•	•	•	•	•	•*	•*	•	•	•	•	•	•	•	•	•	•	•	•	•	•	•	•	•	•	•	•	•	•	•	•

\*Available only on 24", 42", and 48" wide    \*Not available on 39", 42", 45", and 48" wide

**Construction Upgrades**

APC	ET	PE
•	•	•

**Door Options**

DPSRR
•

**BASE SINGLE DOOR with WOOD TIERED CUTLERY DIVIDER DRAWER**

15", 18", 21", or 24"

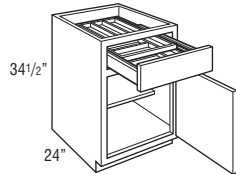

- B15WTCD L or R**
- B18WTCD L or R**
- B21WTCD L or R**
- B24WTCD L or R**

- Adjustable 15" deep shelf.
- Exterior WTCD drawer box height is 3 3/4", interior height of top and bottom tier is 1 3/8".
- Wood Tiered Cutlery Divider Drawer is also available as an accessory. See page 372.

**Custom Modifications**

AUTH	CBO	CCO	CFNTO	CFP	CFRMO	CMAT	CND	DRT	DRWPWR	DRWSEC	DRWTK	EXBK	EX	FB	FD	FFD	FPEB	FTK	FTK_V	ID	INVFRM	LTI	MIP	P	PTOWB	RD	RECTK	RT	SCPDRAW	TD	TOTSSS	TVR_V	VTK	WLI	
•	•	•	•	•	•		•				•*	•	•	•	•	•	•	•	•	•			•	•	•		•	•						•	•

\*Not available on 15" wide

**Construction Upgrades**

APC	ET	PE
•		•

**Door Options**

DPSRR
•

**BASE DOUBLE DOOR with WOOD TIERED CUTLERY DIVIDER DRAWER**

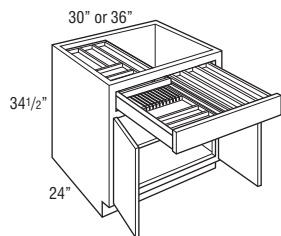
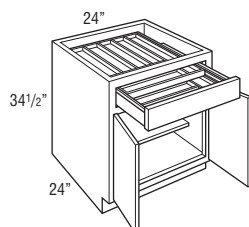

- B24WTCD**
- B30WTCD**
- B36WTCD**

- Adjustable 15" deep shelf.
- Exterior WTCD drawer box height is 3 3/4", interior height of top and bottom tier is 1 3/8".
- Wood Tiered Cutlery Divider Drawer is also available as an accessory. See page 372.

**Custom Modifications**

AUTH	CBO	CCO	CFNTO	CFP	CFRMO	CMAT	CND	DRT	DRWPWR	DRWSEC	DRWTK	EXBK	EX	FB	FD	FFD	FPEB	FTK	FTK_V	ID	INVFRM	LTI	MIP	P	PTOWB	RD	RECTK	RT	SCPDRAW	TD	TOTSSS	TVR_V	VTK	WLI	
•	•	•	•	•	•		•				•	•	•	•	•	•	•	•	•	•			•	•	•		•	•						•	•

**Construction Upgrades**

APC	ET	PE
•		•

**Door Options**

DPSRR
•

**FULL HEIGHT BASE SINGLE DOOR, 6" WIDE**

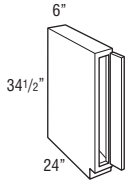

**B6FH L or R**

- Frame opening is 3" wide.
- Cabinet has a full top panel.
- Utilizes a 5 1/2" wide overlay filler as a hinged door.
- When FFDL or FFDR modification is selected, the VTK modification will automatically be selected.

**Custom Modifications**

AUTH	CBO	CCO	CFNTO	CFP	CFRMO	CMAT	CND	DRT	DRWPWR	DRWSEC	DRWTK	EXBK	EX	FB	FD	FFD	FPEB	FTK	FTK_V	ID	INVFRM	LTI	MIP	P	PTOWB	RD	RECTK	RT	SCDRW	TD	TOTSSS	TVR_V	VTK	WLI	
		•	•		•							•	•	•		•*	•	•	•	•	•			•	•	•		•						•	•

\*Includes VTK

**Construction Upgrades**

APC	ET	PE
•		•

**Door Options**

DPSRR

**FULL HEIGHT BASE SINGLE DOOR**

9", 12", 15", 18", 21", or 24"

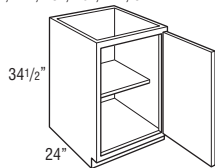

**B9FH L or R**

**B12FH L or R**

**B15FH L or R**

**B18FH L or R**

**B21FH L or R**

**B24FH L or R**

- Adjustable 15" deep shelf.

**Custom Modifications**

AUTH	CBO	CCO	CFNTO	CFP	CFRMO	CMAT	CND	DRT	DRWPWR	DRWSEC	DRWTK	EXBK	EX	FB	FD	FFD	FPEB	FTK	FTK_V	ID	INVFRM	LTI	MIP	P	PTOWB	RD	RECTK	RT	SCDRW	TD	TOTSSS	TVR_V	VTK	WLI	
												•*	•	•	•	•	•	•	•	•	•			•*	•	•	•	•	•	•	•	•	•	•	•

\*Not available on 9", 12", and 15" wide    \*Not available on 9" and 12" wide    \*Not available on 9" wide

**Construction Upgrades**

APC	ET	PE
•		•

**Door Options**

DPSRR
•

**FULL HEIGHT BASE SINGLE DOOR, 40 1/2" HIGH**

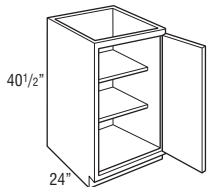

**B1240FH L or R**

**B1540FH L or R**

**B1840FH L or R**

**B2140FH L or R**

**B2440FH L or R**

- Two adjustable 15" deep shelves.

**Custom Modifications**

AUTH	CBO	CCO	CFNTO	CFP	CFRMO	CMAT	CND	DRT	DRWPWR	DRWSEC	DRWTK	EXBK	EX	FB	FD	FFD	FPEB	FTK	FTK_V	ID	INVFRM	LTI	MIP	P	PTOWB	RD	RECTK	RT	SCDRW	TD	TOTSSS	TVR_V	VTK	WLI
												•*	•	•	•	•	•	•	•	•	•			•*	•	•	•	•	•	•	•	•	•	•

\*Not available on 12" and 15" wide    \*Not available on 12" wide

**Construction Upgrades**

APC	ET	PE
•		•

**Door Options**

DPSRR
•

**FULL HEIGHT BASE DOUBLE DOOR**

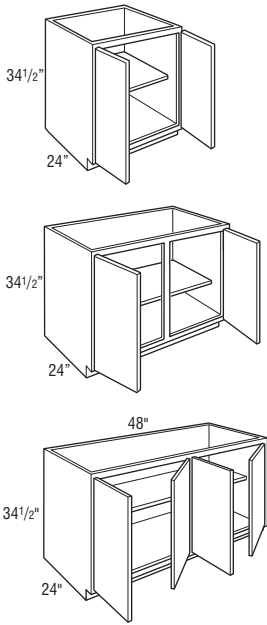

- B24FH**
- B27FH**
- B30FH**
- B33FH**
- B36FH**

- B39FH**
- B42FH**
- B45FH**
- B48FHCS**

- B48FH**
- Adjustable 15" deep shelf.

**Custom Modifications**

AUTH	CBO	CCO	CFNTO	CFP	CFRMO	CMAT	CND	DRT	DRWPWR	DRWSEC	DRWTK	EXBK	EX	FB	FD	FFD	FPEB	FTK	FTK_V	ID	INVFRM	LTI	MIP	P	PTOWB	RD	RECTK	RT	SCPDRW	TD	TOTSSS	TVR_V	VTK	WLI	
•	•	•	•	•	•						•*	•	•	•	•	•	•	•	•	•	•	•	•	•	•	•	•	•	•	•*				•	•

\*Not available on 39", 42", 45", and 48" wide

**Construction Upgrades**

APC	ET	PE
•		•

**Door Options**

DPSRR
•

**FULL HEIGHT BASE DOUBLE DOOR, 40 1/2" HIGH**

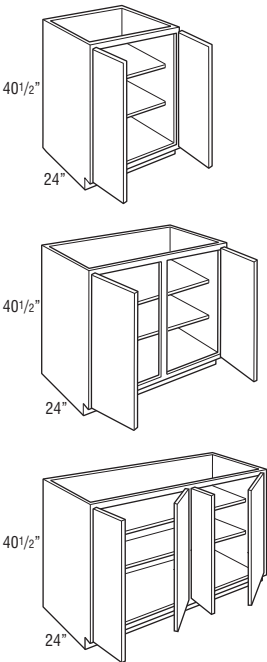

- B2440FH**
- B2740FH**
- B3040FH**
- B3340FH**
- B3640FH**

- B3940FH**
- B4240FH**
- B4540FH**
- B4840FHCS**

- B4840FH**
- Two adjustable 15" deep shelves.

**Custom Modifications**

AUTH	CBO	CCO	CFNTO	CFP	CFRMO	CMAT	CND	DRT	DRWPWR	DRWSEC	DRWTK	EXBK	EX	FB	FD	FFD	FPEB	FTK	FTK_V	ID	INVFRM	LTI	MIP	P	PTOWB	RD	RECTK	RT	SCPDRW	TD	TOTSSS	TVR_V	VTK	WLI	
•	•	•	•	•	•						•*	•	•	•	•	•	•	•	•	•	•	•	•	•	•	•	•	•	•	•				•	•

\*Not available on 39", 42", 45", and 48" wide

**Construction Upgrades**

APC	ET	PE
•		•

**Door Options**

DPSRR
•

**WALL BASE SINGLE DOOR**

12", 15", 18", 21", or 24"

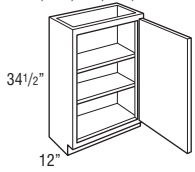

- WB12 L or R**
- WB15 L or R**
- WB18 L or R**
- WB21 L or R**
- WB24 L or R**

- Two full depth shelves.
- Will have the same shelf hole drill pattern as a base cabinet.

**Custom Modifications**

AUTH	CBO	CCO	CFNT0	CFP	CFRMO	CMAT	CND	DRT	DRWPWR	DRWSEC	DRWTK	EXBK	EX	FB	FD	FFD	FPEB	FTK	FTK_V	ID	INVFRM	LTI	MIP	P	PTOWB	RD	RECTK	RT	SCPDWR	TD	TOTSSS	TVR_V	VTK	WLI	
•	•	•	•	•	•	•	•	•	•	•	•	•	•	•	•	•	•	•	•	•*	•	•	•	•	•	•	•	•*	•	•	•	•	•	•	•

\*Not available on 12" wide \*RECTKALL and RECTKBK not available

**Construction Upgrades**

APC	ET	PE
•	•	•

**Door Options**

DPSRR
•

**WALL BASE DOUBLE DOOR**

24", 27", 30", 33", or 36"

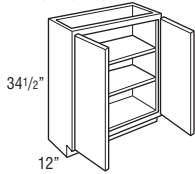

39", 42", 45", or 48"

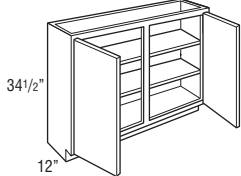

48"

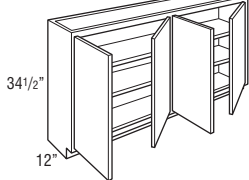

- WB24**
- WB27**
- WB30**
- WB33**
- WB36**
  
- WB39**
- WB42**
- WB45**
- WB48CS**

- WB48**
- Two full depth shelves.
- Will have the same shelf hole drill pattern as a base cabinet.

**Custom Modifications**

AUTH	CBO	CCO	CFNT0	CFP	CFRMO	CMAT	CND	DRT	DRWPWR	DRWSEC	DRWTK	EXBK	EX	FB	FD	FFD	FPEB	FTK	FTK_V	ID	INVFRM	LTI	MIP	P	PTOWB	RD	RECTK	RT	SCPDWR	TD	TOTSSS	TVR_V	VTK	WLI	
•	•	•	•	•	•	•	•	•	•	•	•	•	•	•	•	•	•	•	•	•	•	•	•	•	•	•	•	•*	•	•	•	•*	•	•	•

\*Not available on 39", 42", 45", and 48" wide \*RECTKALL and RECTKBK not available

**Construction Upgrades**

APC	ET	PE
•	•	•

**Door Options**

DPSRR
•

**30" SUPERCABINET™**

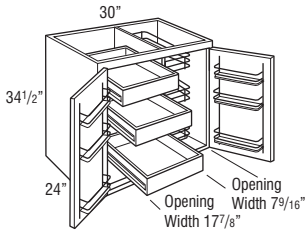

**BSC30RP**

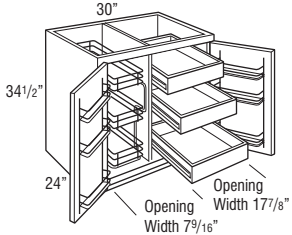

**BSC30PR**

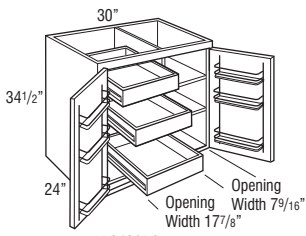

**BSC30RS**

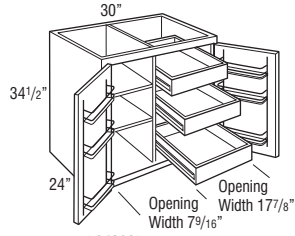

**BSC30SR**

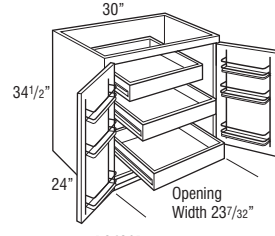

**BSC30R**

**BSC30RP**

**BSC30PR**

**BSC30RS**

**BSC30SR**

**BSC30R**

- Nomenclature represents left to right order of interior components.  
Example: BSC30RS = Base SuperCabinet™ 30" Roll-out Shelves.
- Shelves are adjustable and 20" deep.
- Roll trays are Full Extension side-mounted.
- Cabinets utilize 170° hinge. For sufficient pull-out clearance, 12" of adjacent space is required for door to open 170° when installed near a wall or corner.
- Each door features a chrome and wood three-tiered rack.
- Door rack width is 9 3/8".
- Door rack depth is 3".
- Integrated soft-close hinge not included. Premium door mechanism installed.

**Custom Modifications**

AUTH	CBO	CCO	CFNTD	CFP	CFRMO	CMAT	CND	DRT	DRWPWR	DRWSEC	DRWTK	EXBK	EX	FB	FD	FFD	FPEB	FTK	FTK_V	ID	INVFRM	LTI	MIP	P	PTOWB	RD	RECTK	RT	SCPDW	TD	TOTSSS	TVR_V	VTK	WLI		
•	•	•	•	•	•	•	•	•	•	•	•	•	•	•	•	•	•	•	•	•	•	•	•	•	•	•	•	•	•	•	•	•	•	•	•	•

**Construction Upgrades**

APC	ET	PE
•	•	•

**Door Options**

DPSRR
•

**30" SUPERCABINET™ VERSION 2**

**BV2SC30PR**

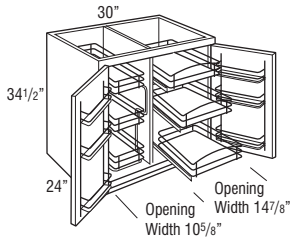

**BV2SC30PR**

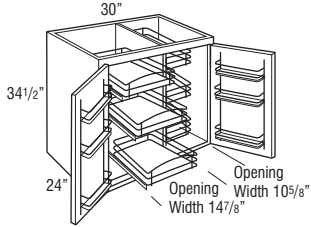

**BV2SC30RP**

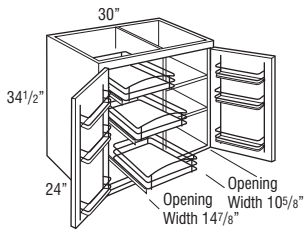

**BV2SC30RS**

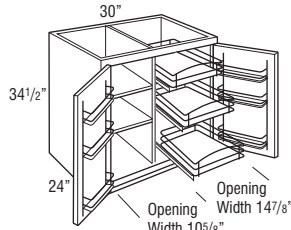

**BV2SC30SR**

**BV2SC30RP**

**BV2SC30RS**

**BV2SC30SR**

- Nomenclature represents left to right order of interior components.  
Example: BV2SC30RS = Base Version 2 SuperCabinet™ 30" Roll-out Shelves.
- Shelves are adjustable and 20" deep.
- Chrome Roll-out trays feature smart close.
- Cabinets utilize 170° hinge. For sufficient pull-out clearance, 12" of adjacent space is required for door to open 170° when installed near a wall or corner.
- Each door features a chrome and wood three-tiered rack.
- Door rack width is 9 3/8".
- Door rack depth is 3".
- Side pull-outs feature 3 adjustable chrome and wood baskets on frame with smart close.
- Integrated soft-close hinge not included. Premium door mechanism installed.

**Custom Modifications**

AUTH	CBO	CCO	CFNTO	CFP	CFRMO	CMAT	CND	DRT	DRWPWR	DRWSEC	DRWTK	EXBK	EX	FB	FD	FFD	FPFB	FTK	FTK_V	ID	INVRM	LTI	MIP	P	PTOWB	RD	RECTK	RT	SCDRW	TD	TOTSS	TVR_V	VTK	WLI	
•	•	•	•	•	•	•	•	•	•	•	•	•	•	•	•	•	•	•	•	•	•	•	•	•	•	•	•	•	•	•	•	•	•	•	•

**Construction Upgrades**

APC	ET	PE
•	•	•

**Door Options**

DPSRR
•



# 36" SUPERCABINET™

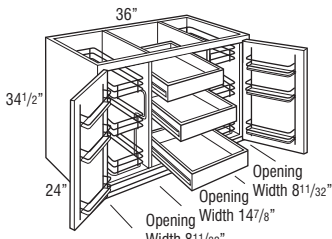

**BSC36PRP**

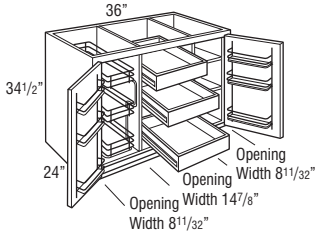

**BSC36PRS**

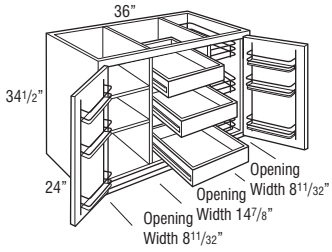

**BSC36SRP**

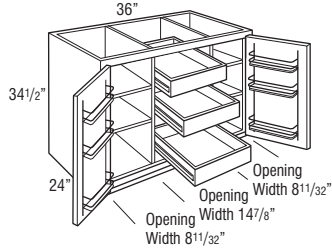

**BSC36SRS**

## BSC36PRP

## BSC36PRS

## BSC36SRP

## BSC36SRS

- Nomenclature represents left to right order of interior components.  
Example: BSC36PRS = Base SuperCabinet™ 36" Pull-out Roll-out Shelves.
- Shelves are adjustable and 20" deep.
- Roll trays are Full Extension side-mounted.
- Cabinets utilize 170° hinge. For sufficient pull-out clearance, 12" of adjacent space is required for door to open 170° when installed near a wall or corner.
- Each door features a chrome and wood three-tiered rack.
- Door rack width is 12 3/8".
- Door rack depth is 3".
- Integrated soft-close hinge not included. Premium door mechanism installed.

### Custom Modifications

AUTH	CBO	CCO	CFNTD	CFP	CFRMO	CMAT	CND	DRT	DRWPWR	DRWSEC	DRWTK	EXBK	EX	FB	FFD	FPEB	FTK	FTK_V	ID	INVFRM	LTI	MIP	P	PTOWB	RD	RECTK	RT	SCPDRW	TD	TOTSSS	TVR_V	VTK	WLI	
•	•	•	•	•	•						•	•	•	•		•	•	•				•				•							•	•

### Construction Upgrades

APC	ET	PE
•		•

### Door Options

DPSRR
•

**36" SUPERCABINET™ VERSION 2**

**BV2SC36PRP**

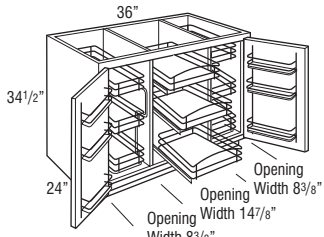

**BV2SC36PRP**

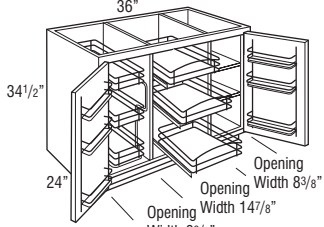

**BV2SC36PRS**

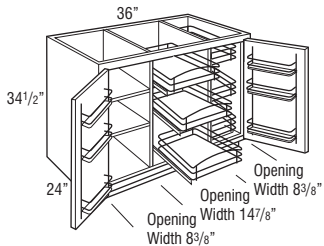

**BV2SC36SRP**

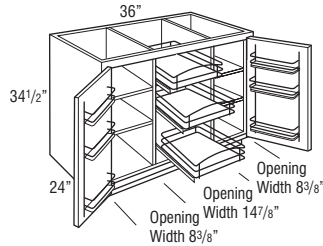

**BV2SC36SRS**

**BV2SC36PRS**

**BV2SC36SRP**

**BV2SC36SRS**

- Nomenclature represents left to right order of interior components.  
Example: BV2SC36PRS = Base Version 2 SuperCabinet™ 36" Pull-out Roll-out Shelves.
- Shelves are adjustable and 20" deep.
- Chrome Roll-out trays feature smart close.
- Cabinets utilize 170° hinge. For sufficient pull-out clearance, 12" of adjacent space is required for door to open 170° when installed near a wall or corner.
- Each door features a chrome and wood three-tiered rack.
- Door rack width is 13 7/8".
- Door rack depth is 3".
- Side pull-outs feature 3 adjustable chrome and wood baskets on frame with smart close.
- Integrated soft-close hinge not included. Premium door mechanism installed.

**Custom Modifications**

AUTH	CBO	CCO	CFNTO	CFP	CFRMO	CMAT	CND	DRT	DRWPWR	DRWSEC	DRWTK	EXBK	EX	FB	FD	FFD	FPFB	FTK	FTK	V	ID	INVFRM	LTI	MIP	P	PTOWB	RD	RECTK	RT	SCDRW	TD	TOTSSS	TVR	V	VTK	WLI		
•	•	•	•	•	•	•	•	•	•	•	•	•	•	•	•	•	•	•	•	•	•	•	•	•	•	•	•	•	•	•	•	•	•	•	•	•	•	•

**Construction Upgrades**

APC	ET	PE
•	•	•

**Door Options**

DPSRR
•

**BASE with ROLL TRAYS**

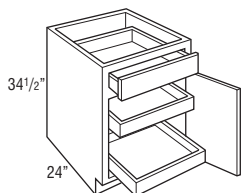

- B12RT L or R**
- B15RT L or R**
- B18RT L or R**
- B21RT L or R**
- B24RT L or R**

- 2 roll trays standard.
- Cabinet may accommodate up to 4 roll trays, which may be purchased separately for field installation. See page 377.

**Custom Modifications**

AUTH	CBO	CCO	CFNTO	CFP	CFRMO	CMAT	CND	DRT	DRWPWR	DRWSEC	DRWTK	EXBK	EX	FB	FD	FFD	FPEB	FTK	FTK_V	ID	INVFRM	LTI	MIP	P	PTOWB	RD	RECTK	RT	SCPDRW	TD	TOTSSS	TVR_V	VTK	WLI	
•	•	•	•	•	•		•	•	•*	•*	•*	•	•	•			•	•	•	•*				•		•	•	•						•	•

\*Not available on 12" and 15" wide      \*Not available on 12" wide

**Construction Upgrades**

APC	ET	PE
•	•	•

**Door Options**

DPSRR
•

**BASE DOUBLE DOOR with ROLL TRAYS**

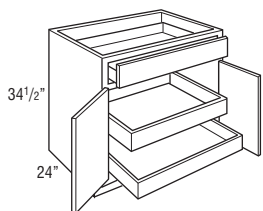

- B24RT**
- B27RT**
- B30RT**
- B33RT**
- B36RT**

- 2 roll trays standard.
- Cabinet has butt doors, no center stile.
- Cabinet may accommodate up to 4 roll trays, which may be purchased separately for field installation. See page 377.

**Custom Modifications**

AUTH	CBO	CCO	CFNTO	CFP	CFRMO	CMAT	CND	DRT	DRWPWR	DRWSEC	DRWTK	EXBK	EX	FB	FD	FFD	FPEB	FTK	FTK_V	ID	INVFRM	LTI	MIP	P	PTOWB	RD	RECTK	RT	SCPDRW	TD	TOTSSS	TVR_V	VTK	WLI	
•	•	•	•	•	•		•	•	•	•*	•	•	•	•			•	•	•	•				•		•	•	•						•	•

\*Available only on 24" wide

**Construction Upgrades**

APC	ET	PE
•	•	•

**Door Options**

DPSRR
•

**BASE DOUBLE DOOR with ROLL TRAYS**

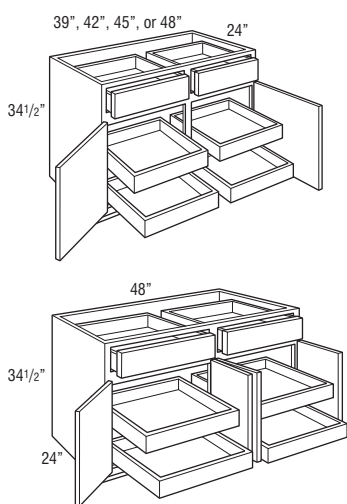

- B39RT**
- B42RT**
- B45RT**
- B48CSRT**

**B48RT**

- 4 roll trays standard.
- Cabinet may accommodate up to 8 roll trays, which may be purchased separately for field installation. See page 377.

**Custom Modifications**

AUTH	CBO	CCO	CFNTO	CFP	CFRMO	CMAT	CND	DRT	DRWPWR	DRWSEC	DRWTK	EXBK	EX	FB	FD	FFD	FPEB	FTK	FTK_V	ID	INVFRM	LTI	MIP	P	PTOWB	RD	RECTK	RT	SCPDRW	TD	TOTSSS	TVR_V	VTK	WLI	
•	•	•	•	•	•		•	•	•	•*	•	•	•	•			•	•	•	•				•		•	•	•						•	•

\*Available only on 42" and 48" wide

**Construction Upgrades**

APC	ET	PE
•	•	•

**Door Options**

DPSRR
•

**BASE FULL HEIGHT with ROLL TRAYS**

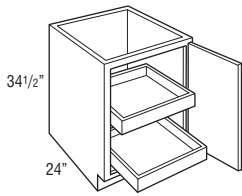

- B12FHRT L or R**
- B15FHRT L or R**
- B18FHRT L or R**
- B21FHRT L or R**
- B24FHRT L or R**

- 2 roll trays standard.
- Cabinet may accommodate up to 5 roll trays, which may be purchased separately for field installation. See page 377.

**Custom Modifications**

AUTH	CBO	CCO	CFNT0	CFP	CFRMO	CMAT	CND	DRT	DRWPWR	DRWSEC	DRWTK	EXBK	EX	FB	FD	FFD	FPEB	FTK	FTK_V	ID	INVFRM	LTI	MIP	P	PTOWB	RD	RECTK	RT	SCPDRW	TD	TOTSSS	TVR_V	VTK	WLI	
•	•	•	•	•	•	•	•	•	•	•	•*	•	•	•	•	•	•	•	•	•	•	•	•	•	•	•	•	•	•	•	•	•	•	•	•

\*Not available on 12" and 15" wide

**Construction Upgrades**

APC	ET	PE
•	•	•

**Door Options**

DPSRR
•

**BASE FULL HEIGHT with ROLL TRAYS**

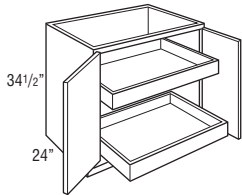

- B24FHRT**
- B27FHRT**
- B30FHRT**
- B33FHRT**
- B36FHRT**

- 2 roll trays standard.
- Cabinet has full height butt doors, no center stile.
- Cabinet may accommodate up to 5 roll trays, which may be purchased separately for field installation. See page 377.

**Custom Modifications**

AUTH	CBO	CCO	CFNT0	CFP	CFRMO	CMAT	CND	DRT	DRWPWR	DRWSEC	DRWTK	EXBK	EX	FB	FD	FFD	FPEB	FTK	FTK_V	ID	INVFRM	LTI	MIP	P	PTOWB	RD	RECTK	RT	SCPDRW	TD	TOTSSS	TVR_V	VTK	WLI	
•	•	•	•	•	•	•	•	•	•	•	•	•	•	•	•	•	•	•	•	•	•	•	•	•	•	•	•	•	•	•	•	•	•	•	•

**Construction Upgrades**

APC	ET	PE
•	•	•

**Door Options**

DPSRR
•

**BASE FULL HEIGHT DOUBLE DOOR with ROLL TRAYS**

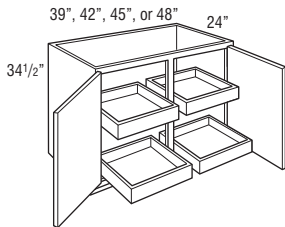

- B39FHRT**
- B42FHRT**
- B45FHRT**
- B48FHCSRT**

- B48FHRT**
- 4 roll trays standard.
- Cabinet may accommodate up to 10 roll trays, which may be purchased separately for field installation. See page 377.

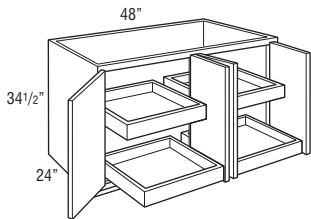

**Custom Modifications**

AUTH	CBO	CCO	CFNT0	CFP	CFRMO	CMAT	CND	DRT	DRWPWR	DRWSEC	DRWTK	EXBK	EX	FB	FD	FFD	FPEB	FTK	FTK_V	ID	INVFRM	LTI	MIP	P	PTOWB	RD	RECTK	RT	SCPDRW	TD	TOTSSS	TVR_V	VTK	WLI	
•	•	•	•	•	•	•	•	•	•	•	•	•	•	•	•	•	•	•	•	•	•	•	•	•	•	•	•	•	•	•	•	•	•	•	•

**Construction Upgrades**

APC	ET	PE
•	•	•

**Door Options**

DPSRR
•

**BASE SINGLE DOOR with WOOD TIERED CUTLERY DIVIDER DRAWER and ROLL TRAYS**

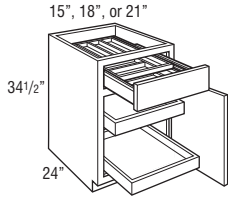

- B15RTWTCD L or R**
- B18RTWTCD L or R**
- B21RTWTCD L or R**
- B24RTWTCD L or R**

- 2 roll trays standard.
- Cabinet may accommodate up to 4 roll trays, which may be purchased separately for field installation. See page 377.
- Exterior WTCD drawer box height is 3 3/4", interior height of top and bottom tier is 1 3/8".
- Wood Tiered Cutlery Divider Drawer is also available as an accessory. See page 372.

**Custom Modifications**

AUTH	CBO	CCO	CFNTO	CFP	CFRMO	CMAT	CND	DRT	DRWPWR	DRWSEC	DRWTK	EXBK	EX	FB	FD	FFD	FPEB	FTK	FTK_V	ID	INVFRM	LTI	MIP	P	PTOWB	RD	RECTK	RT	SCPDRW	TD	TOTSSS	TVR_V	VTK	WLI	
•	•	•	•	•	•	•	•	•	•	•	•*	•	•	•	•	•	•	•	•	•	•	•	•	•	•	•	•	•	•	•	•	•	•	•	•

\*Not available on 15" wide

**Construction Upgrades**

APC	ET	PE
•	•	•

**Door Options**

DPSRR
•

**BASE DOUBLE DOOR with WOOD TIERED CUTLERY DIVIDER DRAWER and ROLL TRAYS**

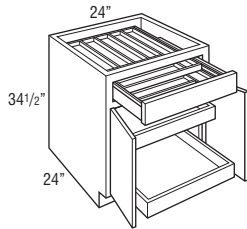

**B24RTWTCD**

**B30RTWTCD**

**B36RTWTCD**

- 2 roll trays standard.
- Cabinet may accommodate up to 4 roll trays, which may be purchased separately for field installation. See page 377.
- Exterior WTCD drawer box height is 3 3/4", interior height of top and bottom tier is 1 3/8".
- Wood Tiered Cutlery Divider Drawer is also available as an accessory. See page 372.

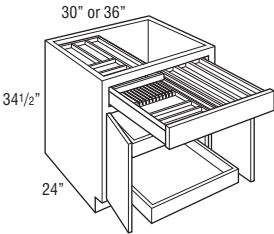

**Custom Modifications**

AUTH	CBO	CCO	CFNTO	CFP	CFRMO	CMAT	CND	DRT	DRWPWR	DRWSEC	DRWTK	EXBK	EX	FB	FD	FFD	FPEB	FTK	FTK_V	ID	INVFRM	LTI	MIP	P	PTOWB	RD	RECTK	RT	SCPDRW	TD	TOTSSS	TVR_V	VTK	WLI	
•	•	•	•	•	•	•	•	•	•	•	•	•	•	•	•	•	•	•	•	•	•	•	•	•	•	•	•	•	•	•	•	•	•	•	•

**Construction Upgrades**

APC	ET	PE
•	•	•

**Door Options**

DPSRR
•

**POTS & PANS ORGANIZER BASE with DRAWER**

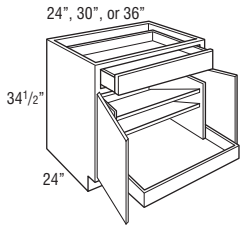
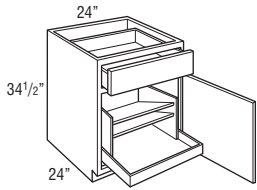

**B24PS L or R**

**B24PS**

**B30PS**

**B36PS**

- Cabinet has butt doors, no center stile.
- Cabinet has bottom roll tray with double lid storage shelves above.
- Base Pan Storage unit is also available as an accessory for field installation. See page 370.

**Custom Modifications**

AUTH	CBO	CCO	CFNTO	CFP	CFRMO	CMAT	CND	DRT	DRWPWR	DRWSEC	DRWTK	EXBK	EX	FB	FD	FFD	FPEB	FTK	FTK_V	ID	INVFRM	LTI	MIP	P	PTOWB	RD	RECTK	RT	SCDRW	TD	TOTSSS	TVR_V	VTK	WLI	
•	•	•	•	•	•	•	•	•	•	•*	•	•	•	•	•	•	•	•	•	•	•	•	•	•	•	•	•	•	•	•	•	•	•	•	•

\*Available only on 24" wide

**Construction Upgrades**

APC	ET	PE
•	•	•

**Door Options**

DPSRR
•

**BASE POTS & PANS PULL-OUT**

**BPPP24 L or R**

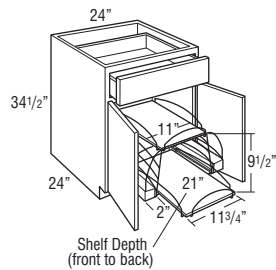
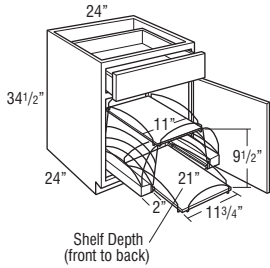

**BPPP24**

- Full Extension slide-out shelves pull out independently.
- Pots and Pans Pull-out is also available as an accessory for field installation. See page 373.
- For full access from both sides of unit, do not install against a wall or next to deeper appliances and cabinets.

**Custom Modifications**

AUTH	CBO	CCO	CFNTO	CFP	CFRMO	CMAT	CND	DRT	DRWPWR	DRWSEC	DRWTK	EXBK	EX	FB	FD	FFD	FPEB	FTK	FTK_V	ID	INVFRM	LTI	MIP	P	PTOWB	RD	RECTK	RT	SCDRW	TD	TOTSSS	TVR_V	VTK	WLI	
•	•	•	•	•	•	•	•	•	•	•	•	•	•	•	•	•	•	•	•	•	•	•	•	•	•	•	•	•	•	•	•	•	•	•	•

**Construction Upgrades**

APC	ET	PE
•	•	•

**Door Options**

DPSRR
•

**BASE POTS & PANS PULL-OUT**

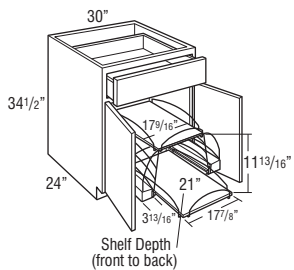

**BPPP30**

- Full Extension slide-out shelves pull out independently.
- Pots and Pans Pull-out is also available as an accessory for field installation. See page 373.
- For full access from both sides of unit, do not install against a wall or next to deeper appliances and cabinets.

**Custom Modifications**

AUTH	CBO	CCO	CFNTO	CFP	CFRMO	CMAT	CND	DRT	DRWPWR	DRWSEC	DRWTK	EXBK	EX	FB	FD	FFD	FPEB	FTK	FTK_V	ID	INVFRM	LTI	MIP	P	PTOWB	RD	RECTK	RT	SCPDRW	TD	TOTSSS	TVR	V	VTK	WLI	
•	•	•	•	•	•		•		•		•	•	•	•			•	•	•				•			•		•						•	•	

**Construction Upgrades**

APC	ET	PE
•		•

**Door Options**

DPSRR
•

**BASE with FOOD STORAGE CONTAINER ORGANIZER**

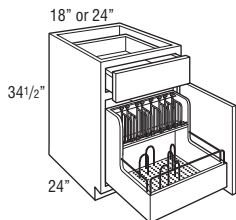

**B18FSCO L or R**

**B24FSCO L or R**

- Pull-out features natural finished hardwood dovetailed box with chrome rails on lower section with undermount smart close guides.
- Includes seven chrome "U" pegs to use on the pegboard bottom to customize the fit to container sizes.
- Adjustable clip-on lid dividers included to fit with a variety of lid shapes. 18" wide includes five dividers, 24" wide includes eight dividers.
- Front of pull-out is routed for easy access.

**Custom Modifications**

AUTH	CBO	CCO	CFNTO	CFP	CFRMO	CMAT	CND	DRT	DRWPWR	DRWSEC	DRWTK	EXBK	EX	FB	FD	FFD	FPEB	FTK	FTK_V	ID	INVFRM	LTI	MIP	P	PTOWB	RD	RECTK	RT	SCPDRW	TD	TOTSSS	TVR	V	VTK	WLI	
•	•	•	•	•	•		•		•		•	•	•	•			•	•	•				•			•		•						•	•	

**Construction Upgrades**

APC	ET	PE
•		•

**Door Options**

DPSRR
•

**BASE with CAN and WINE BOTTLE PULL-OUTS**

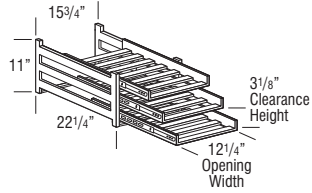
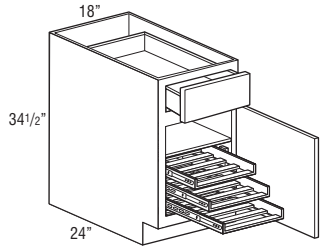

**B18CWP18 L or R**

- Pull-outs feature natural finished hardwood with side-mounted guides (smart close not included).
- One adjustable full depth shelf.
- Holds eighteen wine bottles.
- Insert not available as a field installed kit.

**Custom Modifications**

AUTH	CBO	CCO	CFNTO	CFP	CFRMO	CMAT	CND	DRT	DRWPWR	DRWSEC	DRWTK	EXBK	EX	FB	FD	FFD	FPEB	FTK	FTK_V	ID	INVFRM	LTI	MIP	P	PTOWB	RD	RECTK	RT	SCPDRW	TD	TOTSSS	TVR_V	VTK	WLI		
•	•	•	•	•	•	•	•	•	•	•	•	•	•	•	•	•	•	•	•	•	•	•	•	•	•	•	•	•	•	•	•	•	•	•	•	•

**Construction Upgrades**

APC	ET	PE
•	•	•

**Door Options**

DPSRR
•

**BASE FULL HEIGHT with CAN and WINE BOTTLE PULL-OUTS**

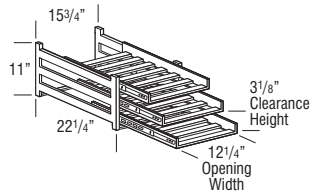
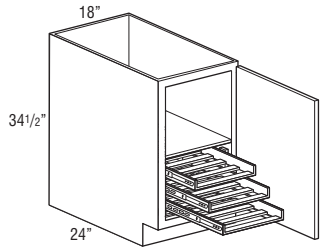

**B18FHCWP18 L or R**

- Pull-outs feature natural finished hardwood with side-mounted guides (smart close not included).
- One adjustable full depth shelf.
- Holds eighteen wine bottles.
- Insert not available as a field installed kit.

**Custom Modifications**

AUTH	CBO	CCO	CFNTO	CFP	CFRMO	CMAT	CND	DRT	DRWPWR	DRWSEC	DRWTK	EXBK	EX	FB	FD	FFD	FPEB	FTK	FTK_V	ID	INVFRM	LTI	MIP	P	PTOWB	RD	RECTK	RT	SCPDRW	TD	TOTSSS	TVR_V	VTK	WLI		
•	•	•	•	•	•	•	•	•	•	•	•	•	•	•	•	•	•	•	•	•	•	•	•	•	•	•	•	•	•	•	•	•	•	•	•	•

**Construction Upgrades**

APC	ET	PE
•	•	•

**Door Options**

DPSRR
•



**BASE with ROLL-OUT TRAY DIVIDER B12TDRO L or R**

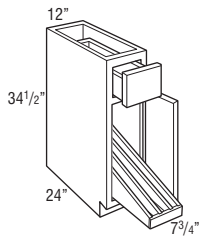

**B15TDRO L or R**

- Dividers are removable.
- 12" - 3 compartments.
- 15" - 4 compartments.
- Roll-out Tray Divider is also available as an accessory for field installation. See page 376.
- Tray divider utilizes smart close undermount guides.

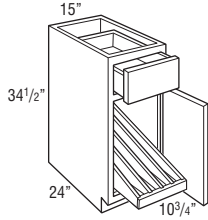

**Custom Modifications**

AUTH	CBO	CCO	CFNTO	CFP	CFRMO	CMAT	CND	DRT	DRWPWR	DRWSEC	DRWTK	EXBK	EX	FB	FD	FFD	FPEB	FTK	FTK_V	ID	INVFRM	LTI	MIP	P	PTOWB	RD	RECTK	RT	SCPDRW	TD	TOTSSS	TVR_V	VTK	WLI	
•	•	•	•	•	•	•	•	•	•	•	•	•	•	•	•	•	•	•	•	•*	•	•	•	•	•	•	•	•	•	•	•	•	•	•	•

\*Not available on 12" wide

**Construction Upgrades**

APC	ET	PE
•	•	•

**Door Options**

DPSRR
•

**BASE with TRAY DIVIDER**

**TD9 L or R**

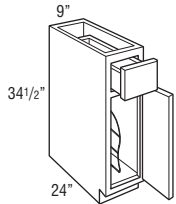

**TD12 L or R**

**TD15 L or R**

- Tray Divider is chrome.
- Tray Divider is also available as an accessory for field installation. See page 375.

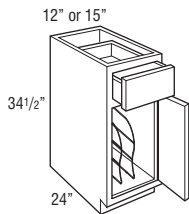

**Custom Modifications**

AUTH	CBO	CCO	CFNTO	CFP	CFRMO	CMAT	CND	DRT	DRWPWR	DRWSEC	DRWTK	EXBK	EX	FB	FD	FFD	FPEB	FTK	FTK_V	ID	INVFRM	LTI	MIP	P	PTOWB	RD	RECTK	RT	SCPDRW	TD	TOTSSS	TVR_V	VTK	WLI	
•	•	•	•	•	•	•	•	•	•	•	•	•	•	•	•	•	•	•	•	•*	•	•*	•	•	•	•	•	•	•	•	•	•	•	•	•

\*Not available on 9" and 12" wide      \*RECTKALL not available on 9" wide

**Construction Upgrades**

APC	ET	PE
•	•	•

**Door Options**

DPSRR
•

**BASE FULL HEIGHT with TRAY DIVIDER**

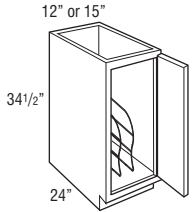
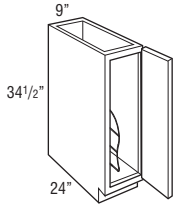

**TD9FH L or R**

**TD12FH L or R**

**TD15FH L or R**

- Tray Divider is chrome.
- Tray Divider is also available as an accessory for field installation. See page 375.

**Custom Modifications**

AUTH	CBO	CCO	CFNTO	CFP	CFRMO	CMAT	CND	DRT	DRWPWR	DRWSEC	DRWTK	EXBK	EX	FB	FD	FFD	FPEB	FTK	FTK_V	ID	INVFRM	LTI	MIP	P	PTOWB	RD	RECTK	RT	SCPDRW	TD	TOTSSS	TVR_V	VTK	WLI		
•	•	•	•	•	•	•	•	•	•	•	•	•	•	•	•	•	•	•	•*	•	•	•*	•	•	•	•	•*	•	•	•	•	•	•	•	•	•

\*Not available on 9" and 12" wide    \*RECTKALL not available on 9" wide

**Construction Upgrades**

APC	ET	PE
•	•	•

**Door Options**

DPSRR
•

**BASE CABINET with MIXER SHELF**

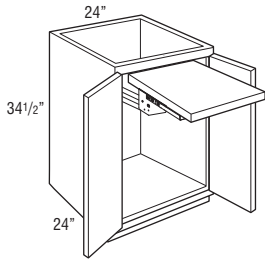
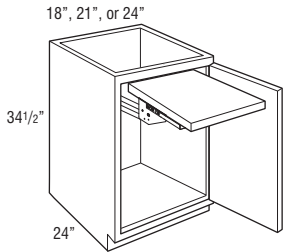

**B18FHMIXSC L or R**

**B21FHMIXSC L or R**

**B24FHMIXSC L or R**

**B24FHMIXSC**

- Includes mixer lift with smart close closing feature.
- Mixer shelf will be 3/4" thick natural finished veneer plywood, mixer shelf dimensions:  
18" wide: 11 3/4" wide x 20" deep.  
21" wide: 14 3/4" wide x 20" deep.  
24" wide: 17 3/4" wide x 20" deep.
- Maximum Weight Capacity for Mixer Shelf: 60 lbs.
- Mixer shelf locks in the fully open position. Release brackets lower the mixer shelf back into the cabinet.
- When in closed position, clearance above shelf is 17 5/8"; clearance below shelf is 7 3/4".

**Custom Modifications**

AUTH	CBO	CCO	CFNTO	CFP	CFRMO	CMAT	CND	DRT	DRWPWR	DRWSEC	DRWTK	EXBK	EX	FB	FD	FFD	FPEB	FTK	FTK_V	ID	INVFRM	LTI	MIP	P	PTOWB	RD	RECTK	RT	SCPDRW	TD	TOTSSS	TVR_V	VTK	WLI		
•	•	•	•	•	•	•	•	•	•	•	•	•	•	•	•	•	•	•	•	•	•	•	•	•	•	•	•	•	•	•	•	•	•	•	•	•

**Construction Upgrades**

APC	ET	PE
STD	•	•

**Door Options**

DPSRR
•

**SINK BASE**

**SB21 L or R**  
**SB24 L or R**

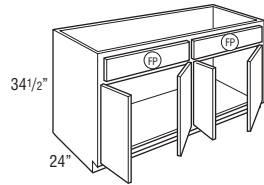
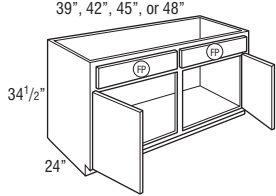
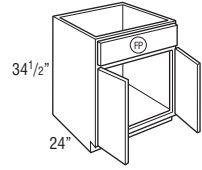
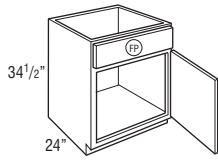

**SB24**  
**SB27**  
**SB30**  
**SB33**  
**SB36**  
  
**SB39**  
**SB42**  
**SB45**  
**SB48CS**

**SB48**

- Mini Touch-up Kit (MTUK) included. MTUK includes small touch-up marker and small fill stick.

Ⓢ = False Panel

**Custom Modifications**

AUTH	CBO	CCO	CFNTO	CFP	CFRMO	CMAT	CND	DRT	DRWPWR	DRWSEC	DRWTK	EXBK	EX	FB	FD	FFD	FPEB	FTK	FTK V	ID	INVFRM	LTI	MIP	P	PTOWB	RD	RECTK	RT	SCPDRW	TD	TOTSSS	TVR	V	VTK	WLI	
•	•	•	•	STD	•	•*	•				•+	•	•	•	•	•	•	•	•	•	•	•	•	•	•	•	•	•	•	•	•	•	•	•	•	•

\*Available only on 30", 33", and 36" wide \*Not available on 39", 42", 45", and 48" wide

**Construction Upgrades**

APC	ET	PE
•		•

**Door Options**

DPSRR
•

**SINK BASE with CABMAT™**

**SB30CM**  
**SB33CM**  
**SB36CM**

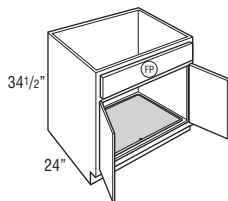

- Mini Touch-up Kit (MTUK) included. MTUK includes small touch-up marker and small fill stick.
- CabMat™ is designed to capture spills and is removable for cleaning.

Model	Liquid Capacity		Cabinet Size	
	Gallons	Liters	Width	Depth
SB30CM	2.0	7.6	30"	24"
SB33CM	2.4	9.0	33"	24"
SB36CM	2.7	10.2	36"	24"

**Custom Modifications**

AUTH	CBO	CCO	CFNTO	CFP	CFRMO	CMAT	CND	DRT	DRWPWR	DRWSEC	DRWTK	EXBK	EX	FB	FD	FFD	FPEB	FTK	FTK V	ID	INVFRM	LTI	MIP	P	PTOWB	RD	RECTK	RT	SCPDRW	TD	TOTSSS	TVR	V	VTK	WLI	
•	•	•	•	STD	•	STD	•				•	•	•	•	•	•	•	•	•	•	•	•	•	•	•	•	•	•	•	•	•	•	•	•	•	•

**Construction Upgrades**

APC	ET	PE
•		•

**Door Options**

DPSRR
•

**SINK BASE, 27" DEEP, SINGLE or DOUBLE DOOR**

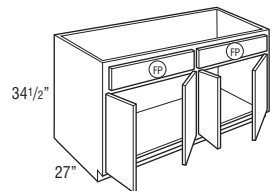
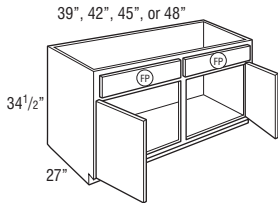
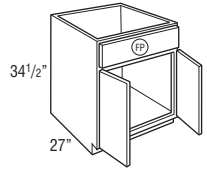
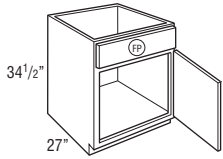

**SB243427 L or R**

**SB243427**

**SB273427**

**SB303427**

**SB333427**

**SB363427**

**SB393427**

**SB423427**

**SB453427**

**SB483427CS**

**SB483427**

- Mini Touch-up Kit (MTUK) included. MTUK includes small touch-up marker and small fill stick.

**(FP) = False Panel**

**Custom Modifications**

AUTH	CBO	CCO	CFNTO	CFP	CFRMO	CMAT	CND	DRT	DRWPWR	DRWSEC	DRWTK	EXBK	EX	FB	FD	FFD	FPEB	FTK	FTK	V	ID	INVERM	LTI	MIP	P	PTOWB	RD	RECTK	RT	SCPDRW	TD	TOTSSS	TVR	V	VTK	WLI		
•	•	•	•	•	•	•	•	•	•	•	•	•	•	•	•	•	•	•	•	•	•	•	•	•	•	•	•	•	•	•	•	•	•	•	•	•	•	•

**Construction Upgrades**

APC	ET	PE
•	•	•

**Door Options**

DPSRR
•

**SINK BASE with TILT-OUT TRAYS**

**SB21ST L or R**  
**SB24ST L or R**

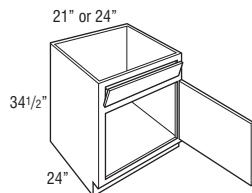

**SB24ST**  
**SB27ST**

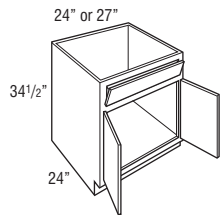

**SB30ST**  
**SB33ST**  
**SB36ST**

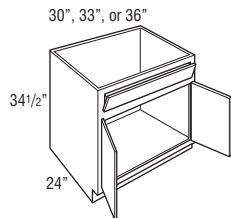

**SB39ST**  
**SB42ST**  
**SB45ST**  
**SB48CSST**

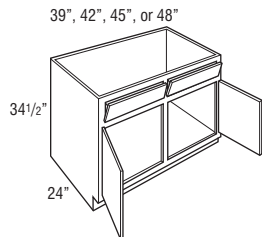

**SB48ST**

- Tilt-out trays are stain resistant, moisture resistant plastic to allow storage of sponges and other cleaning materials.
- Mini Touch-up Kit (MTUK) included. MTUK includes small touch-up marker and small fill stick.
- Includes two tilt-out trays on 30"-48" wide.
- Tilt-out trays are also available as an accessory for field installation. See page 375.

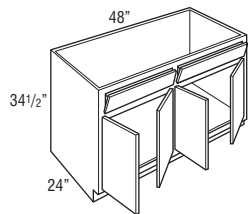

**Custom Modifications**

AUTH	CBO	CCO	CFNTO	CFP	CFRMO	CMAT	CND	DRT	DRWPWR	DRWSEC	DRWTK	EXBK	EX	FB	FFD	FPEB	FTK	FTK_V	ID	INVFRM	LTI	MIP	P	PTOWB	RD	RECTK	RT	SCPDRW	TD	TOTSSS	TVR	V	VTK	WLI		
•	•	•	•	•	•	•*	•				•*	•	•	•	•	•	•	•	•	•	•	•	•	•	•	•	•	•	•	•	•	•	•	•	•	•

\*Available only on 30", 33", and 36" wide    \*Not available on 39", 42", 45", and 48" wide

**Construction Upgrades**

APC	ET	PE
•		•

**Door Options**

DPSRR
•

**SINK BASE with TILT-OUT TRAYS and CABMAT™**

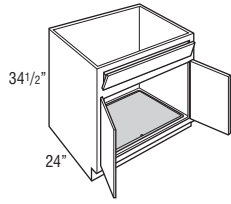

- SB30STCM**
- SB33STCM**
- SB36STCM**

- Mini Touch-up Kit (MTUK) included. MTUK includes small touch-up marker and small fill stick.
- CabMat™ is designed to capture spills and is removable for cleaning.
- Tilt-out trays are stain resistant, moisture resistant plastic to allow storage of sponges and other cleaning materials.
- Includes two tilt-out trays.
- Tilt-out trays are also available as an accessory for field installation. See page 375.

Model	Liquid Capacity		Cabinet Size	
	Gallons	Liters	Width	Depth
SB30STCM	2.0	7.6	30"	24"
SB33STCM	2.4	9.0	33"	24"
SB36STCM	2.7	10.2	36"	24"

**Custom Modifications**

AUTH	CBO	CCO	CFNTO	CFP	CFRMO	CMAT	CND	DRT	DRWPWR	DRWSEC	DRWTK	EXBK	EX	FB	FD	FFD	FPEB	FTK	FTK_V	ID	INVERM	LTI	MIP	P	PTOWB	RD	RECTK	RT	SCDRW	TD	TOTSSS	TVR_V	VTK	WLI	
•	•	•	•	•	•	•	•	•	•	•	•	•	•	•	•	•	•	•	•	•	•	•	•	•	•	•	•	•	•	•	•	•	•	•	•

**Construction Upgrades**

APC	ET	PE
•	•	•

**Door Options**

DPSRR
•

**SINK BASE with TILT-OUT TRAYS, 27" DEEP**

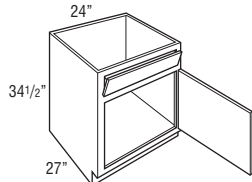

**SB243427ST L or R**

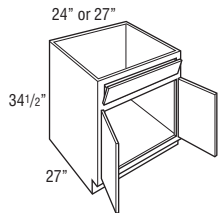

**SB243427ST-SB273427ST**

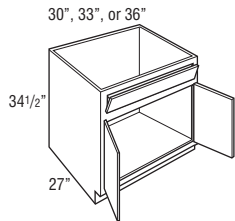

**SB303427ST-SB363427ST**

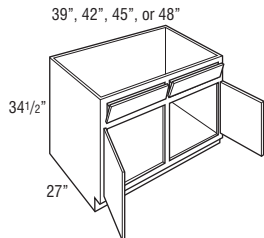

**SB393427ST-SB483427CSST**

**SB243427ST L or R**

- SB243427ST**
- SB273427ST**

- SB303427ST**
- SB333427ST**
- SB363427ST**

- SB393427ST**
- SB423427ST**
- SB453427ST**
- SB483427CSST**

**SB483427ST**

- Tilt-out trays are stain resistant, moisture resistant plastic to allow storage of sponges and other cleaning materials.
- Mini Touch-up Kit (MTUK) included. MTUK includes small touch-up marker and small fill stick.
- Includes two tilt-out trays on 30"-48" wide.
- Tilt-out trays are also available as an accessory for field installation. See page 375.

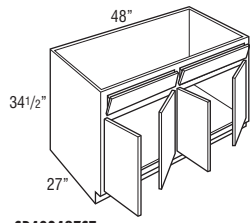

**SB483427ST**

**Custom Modifications**

AUTH	CBO	CCO	CFNTO	CFP	CFRMO	CMAT	CND	DRT	DRWPWR	DRWSEC	DRWTK	EXBK	EX	FB	FD	FFD	FPEB	FTK	FTK_V	ID	INVERM	LTI	MIP	P	PTOWB	RD	RECTK	RT	SCDRW	TD	TOTSSS	TVR_V	VTK	WLI
•	•	•	•	•	•	•	•	•	•	•	•	•	•	•	•	•	•	•	•	•	•	•	•	•	•	•	•	•	•	•	•	•	•	•

**Construction Upgrades**

APC	ET	PE
•	•	•

**Door Options**

DPSRR
•

**SINK BASE SUPERCABINET™**

30", 33", or 36"

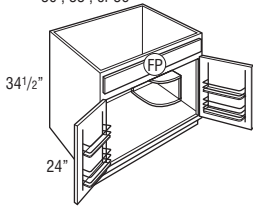

ⓁⓁ = False Panel

**Custom Modifications**

AUTH	CBO	CCO	CFNTO	CFP	CFRMO	CMAT	CND	DRT	DRWPWR	DRWSEC	DRWTK	EXBK	EX	FB	FD	FFD	FPEB	FTK	FTK_V	ID	INVFRM	LTI	MIP	P	PTOWB	RD	RECTK	RT	SCPDRW	TD	TOTSSS	TVR_V	VTK	WLI	
•	•	•	•	•	•	•	•	•	•	•	•	•	•	•	•	•	•	•	•	•	•	•	•	•	•	•	•	•	•	•	•	•	•	•	•

**Construction Upgrades**

APC	ET	PE
•	•	•

**Door Options**

DPSRR
•

**SB30S**

**SB33S**

**SB36S**

- Quarter Round Reversible Shelf for left or right applications will be constructed from 3/4" thick laminated furniture board. (Shelf shipped secure, can be positioned in left or right corner.)
- Mini Touch-up Kit (MTUK) included. MTUK includes small touch-up marker and small fill stick.
- All load bearing surfaces meet KCMA standards of 15 lbs. per square foot.
- Each door features a chrome and wood two-tiered rack.
- Door rack width is 11 3/8" on 30" and 33" wide cabinets and 14 3/8" on 36" wide cabinet.
- Door rack depth is 3 1/2".

**SINK BASE SUPERCABINET™ with CABMAT™**

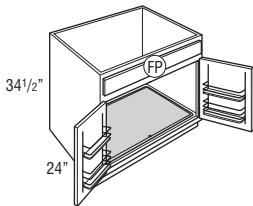

**SB30SCM**

**SB33SCM**

**SB36SCM**

- Mini Touch-up Kit (MTUK) included. MTUK includes small touch-up marker and small fill stick.
- CabMat™ is designed to capture spills and is removable for cleaning.
- All load bearing surfaces meet KCMA standards of 15 lbs. per square foot.
- Each door features a chrome and wood two-tiered rack.
- Door rack width is 11 3/8" on 30" and 33" wide cabinets and 14 3/8" on 36" wide cabinet.
- Door rack depth is 3 1/2".

Model	Liquid Capacity		Cabinet Size	
	Gallons	Liters	Width	Depth
SB30SCM	2.0	7.6	30"	24"
SB33SCM	2.4	9.0	33"	24"
SB36SCM	2.7	10.2	36"	24"

**Custom Modifications**

AUTH	CBO	CCO	CFNTO	CFP	CFRMO	CMAT	CND	DRT	DRWPWR	DRWSEC	DRWTK	EXBK	EX	FB	FD	FFD	FPEB	FTK	FTK_V	ID	INVFRM	LTI	MIP	P	PTOWB	RD	RECTK	RT	SCPDRW	TD	TOTSSS	TVR_V	VTK	WLI	
•	•	•	•	•	•	•	•	•	•	•	•	•	•	•	•	•	•	•	•	•	•	•	•	•	•	•	•	•	•	•	•	•	•	•	•

**Construction Upgrades**

APC	ET	PE
•	•	•

**Door Options**

DPSRR
•

**SINK BASE SUPERCABINET™ with TILT-OUT TRAYS**

30", 33", or 36"

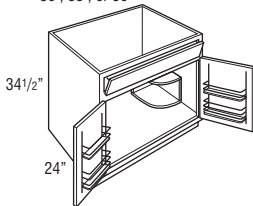

**SB30STS**

**SB33STS**

**SB36STS**

- Quarter Round Reversible Shelf for left or right applications will be constructed from 3/4" thick laminated furniture board. (Shelf shipped secure, can be positioned in left or right corner.)
- Mini Touch-up Kit (MTUK) included. MTUK includes small touch-up marker and small fill stick.
- Includes two tilt-out trays.
- Tilt-out trays are stain resistant, moisture resistant plastic to allow storage of sponges and other cleaning materials.
- Tilt-out trays are also available as an accessory for field installation. See page 375.
- All load bearing surfaces meet KCMA standards of 15 lbs. per square foot.
- Each door features a chrome and wood two-tiered rack.
- Door rack width is 11 3/8" on 30" and 33" wide cabinets and 14 3/8" on 36" wide cabinet.
- Door rack depth is 3 1/2".

**Custom Modifications**

AUTH	CBO	CCO	CFNTO	CFP	CFRMO	CMAT	CND	DRT	DRWPWR	DRWSEC	DRWTK	EXBK	EX	FB	FD	FFD	FPEB	FTK	FTK_V	ID	INVFRM	LTI	MIP	P	PTOWB	RD	RECTK	RT	SCPDRW	TD	TOTSSS	TVR_V	VTK	WLI	
•	•	•	•	•	•	•	•	•	•	•	•	•	•	•	•	•	•	•	•	•	•	•	•	•	•	•	•	•	•	•	•	•	•	•	•

**Construction Upgrades**

APC	ET	PE
•	•	•

**Door Options**

DPSRR
•

**SINK BASE SUPERCABINET™ with TILT-OUT TRAYS and CABMAT™**

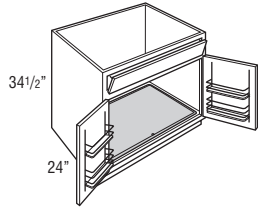

- SB30STSCM**
- SB33STSCM**
- SB36STSCM**

- Mini Touch-up Kit (MTUK) included. MTUK includes small touch-up marker and small fill stick.
- CabMat™ is designed to capture spills and is removable for cleaning.
- Includes two tilt-out trays.
- Tilt-out trays are stain resistant, moisture resistant plastic to allow storage of sponges and other cleaning materials.
- Tilt-out trays are also available as an accessory for field installation. See page 375.
- All load bearing surfaces meet KCMA standards of 15 lbs. per square foot.
- Each door features a chrome and wood two-tiered rack.
- Door rack width is 11 3/8" on 30" and 33" wide cabinets and 14 3/8" on 36" wide cabinet.
- Door rack depth is 3 1/2".

Model	Liquid Capacity		Cabinet Size	
	Gallons	Liters	Width	Depth
SB30STSCM	2.0	7.6	30"	24"
SB33STSCM	2.4	9.0	33"	24"
SB36STSCM	2.7	10.2	36"	24"

**Custom Modifications**

AUTH	CBO	CCO	CFNTO	CFP	CFRMO	CMAT	CND	DRT	DRWPWR	DRWSEC	DRWTK	EXBK	EX	FB	FD	FFD	FPEB	FTK	FTK_V	ID	INVFRM	LTI	MIP	P	PTOWB	RD	RECTK	RT	SCPDRW	TD	TOTSSS	TVR_V	VTK	WLI	
•	•	•	•	•	•	•	•	•	•	•	•	•	•	•	•	•	•	•	•	•	•	•	•	•	•	•	•	•	•	•	•	•	•	•	•

**Construction Upgrades**

APC	ET	PE
•	•	•

**Door Options**

DPSRR
•

**SINK BASE with DRAWER BELOW**

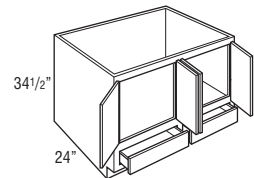
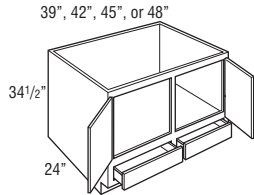
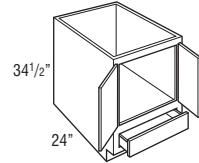
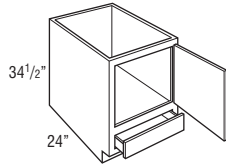

- SB24D L or R**

- SB24D**
- SB27D**
- SB30D**
- SB33D**
- SB36D**

- SB39D**
- SB42D**
- SB45D**
- SB48DCS**

**SB48D**

- Drawers are below full cabinet floor.
- Mini Touch-up Kit (MTUK) included. MTUK includes small touch-up marker and small fill stick.
- Verify that sink, garbage disposal and plumbing fit opening.
- Plumbing going through floor will interfere with drawer operation. 2 3/4" clearance from back of drawer to interior back of cabinet.
- Face frame opening height is 20 1/2".
- Face frame opening height for drawer is 4 1/2".

**Custom Modifications**

AUTH	CBO	CCO	CFNTO	CFP	CFRMO	CMAT	CND	DRT	DRWPWR	DRWSEC	DRWTK	EXBK	EX	FB	FD	FFD	FPEB	FTK	FTK_V	ID	INVFRM	LTI	MIP	P	PTOWB	RD	RECTK	RT	SCPDRW	TD	TOTSSS	TVR_V	VTK	WLI	
•	•	•	•	•	•	•*	•	•	•	•	•	•	•	•	•	•	•	•	•	•	•	•	•	•	•	•	•	•	•	•	•	•	•	•	•

\*Available only on 30", 33", and 36" wide \*Not available on 39", 42", 45", and 48" wide

**Construction Upgrades**

APC	ET	PE
•	•	•

**Door Options**

DPSRR
•



### SINK FRONT BOTTOM

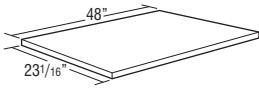

### SFB48

- Designed for use with Sink Bases ordered with CFNTO.
- 3/8" thick.
- Trimmable.

#### Custom Modifications

AUTH	CBO	CCO	CFNTO	CFP	CFRMO	CMAT	CND	DRT	DRWPWR	DRWSEC	DRWTK	EXBK	EX	FB	FD	FFD	FPEB	FTK	FTK_V	ID	INVFRM	LTI	MIP	P	PTOWB	RD	RECTK	RT	SCPDRW	TD	TOTSSS	TVR_V	VTK	WLI			
																																					•

#### Construction Upgrades

APC	ET	PE
•		

#### Door Options

DPSRR

### SQUARE CORNER SINK BASE

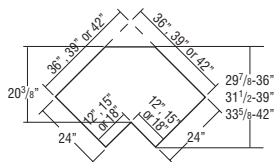
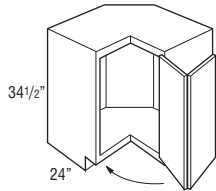

### CS36 L or R

### CS39 L or R

### CS42 L or R

- CS36: Wall width: 36" x 36". Frame 12" x 12".
- CS39: Wall width: 39" x 39". Frame 15" x 15".
- CS42: Wall width: 42" x 42". Frame 18" x 18".
- Mini Touch-up Kit (MTUK) included. MTUK includes small touch-up marker and small fill stick.
- For sufficient dishwasher door clearance and loading/unloading space, a 15" wide base cabinet is recommended for use between a corner sink base and dishwasher.
- Decorative hardware screws must be countersunk to prevent scratching of adjacent cabinets and face frame of CS.
- Integrated soft-close hinge not included.

#### Custom Modifications

AUTH	CBO	CCO	CFNTO	CFP	CFRMO	CMAT	CND	DRT	DRWPWR	DRWSEC	DRWTK	EXBK	EX	FB	FD	FFD	FPEB	FTK	FTK_V	ID	INVFRM	LTI	MIP	P	PTOWB	RD	RECTK	RT	SCPDRW	TD	TOTSSS	TVR_V	VTK	WLI		
•																																				•

#### Construction Upgrades

APC	ET	PE
•		

#### Door Options

DPSRR
•

### ANGLED CORNER SINK BASE

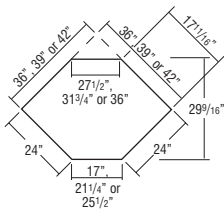
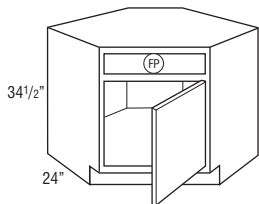

Max. Sink Widths if cut-out is 4" back from face of front frame

(FP) = False Panel

### ACS36 L or R

### ACS39 L or R

### ACS42<sup>†</sup>

- Edges beveled at 45°.
- Mini Touch-up Kit (MTUK) included. MTUK includes small touch-up marker and small fill stick.
- For sufficient dishwasher door clearance and loading/unloading space, a 15" wide base cabinet is recommended for use between a corner sink base and dishwasher.
- For ACS36, full overlay styles use 14 1/2" wide doors with 38NPOHINGE to allow for proper door clearance with adjacent cabinets.

<sup>†</sup>ACS42 has butt doors.

Model	Wall Width	Frame	Maximum Sink Width	Maximum Sink Depth
ACS36	36" x 36"	17"	25 3/4"	27 11/32"
ACS39	39" x 39"	21 1/4"	30"	27 11/32"
ACS42	42" x 42"	25 1/2"	34 1/4"	27 11/32"

#### Custom Modifications

AUTH	CBO	CCO	CFNTO	CFP	CFRMO	CMAT	CND	DRT	DRWPWR	DRWSEC	DRWTK	EXBK	EX	FB	FD	FFD	FPEB	FTK	FTK_V	ID	INVFRM	LTI	MIP	P	PTOWB	RD	RECTK	RT	SCPDRW	TD	TOTSSS	TVR_V	VTK	WLI		
•				•	•	•	•	•	•	•	•	•	•	•	•	•	•	•	•	•	•	•	•	•	•	•	•	•	•	•	•	•	•	•	•	•

#### Construction Upgrades

APC	ET	PE
•		

#### Door Options

DPSRR
•

**ANGLED CORNER SINK FRONT  
without SINK FLOOR**

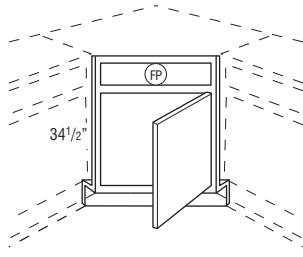

Max. Sink Widths if cut-out is 4" back from face of front frame

FP = False Panel

**Custom Modifications**

AUTH	CBO	CCO	CFNTO	CFP	CFRMO	CMAT	CND	DRT	DRWPWR	DRWSEC	DRWTK	EXBK	EX	FB	FD	FFD	FPEB	FTK	FTK_V	ID	INVFRM	LTI	MIP	P	PTOWB	RD	RECTK	RT	SCPDRW	TD	TOTSSS	TVR_V	VTK	WLI			
			STD	STD																																	

**Construction Upgrades**

APC	ET	PE

**Door Options**

DPSRR

**ACSF36 L or R**  
**ACSF39 L or R**  
**ACSF42<sup>†</sup>**

- Edges beveled at 45°.
  - Angled corner sink front bottom required for field installation. Order separately. See next item.
  - Toekick and toekick retainer shipped unattached from the face frame.
  - For ACSF36, full overlay styles use 14 1/2" wide doors with 38NPOHINGE to allow for proper door clearance with adjacent cabinets.
- <sup>†</sup>ACSF42 has butt doors.

Model	Wall Width	Frame	Maximum Sink Width	Maximum Sink Depth
ACSF36	36" x 36"	17"	25 3/4"	27 11/32"
ACSF39	39" x 39"	21 1/4"	30"	27 11/32"
ACSF42	42" x 42"	25 1/2"	34 1/4"	27 11/32"

**ANGLED CORNER SINK FRONT  
BOTTOM**

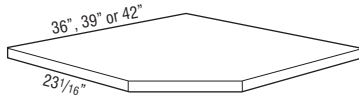

**ACSF36**  
**ACSF39**  
**ACSF42**

- Designed for use with Angled Corner Sink Front.
- Cabinet bottom is sized for use next to an adjacent wall or cabinet with flush ends.
- 3/8" thick.

**Custom Modifications**

AUTH	CBO	CCO	CFNTO	CFP	CFRMO	CMAT	CND	DRT	DRWPWR	DRWSEC	DRWTK	EXBK	EX	FB	FD	FFD	FPEB	FTK	FTK_V	ID	INVFRM	LTI	MIP	P	PTOWB	RD	RECTK	RT	SCPDRW	TD	TOTSSS	TVR_V	VTK	WLI				

**Construction Upgrades**

APC	ET	PE

**Door Options**

DPSRR

**COUNTRY SINK BASE**

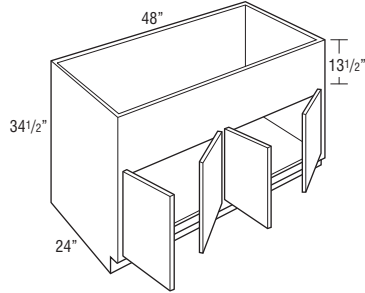
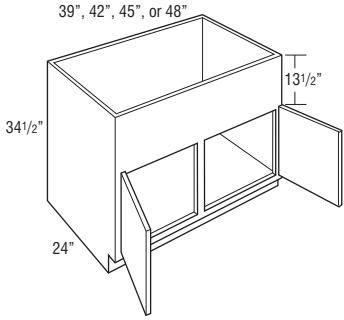
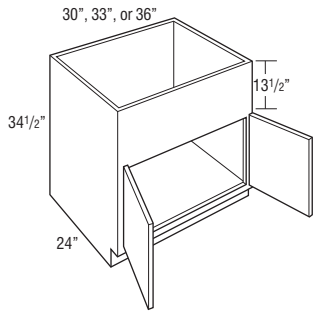

**CNTYSB30**

**CNTYSB33**

**CNTYSB36**

**CNTYSB39**

**CNTYSB42**

**CNTYSB45**

**CNTYSB48CS**

**CNTYSB48**

- 13 1/2" panel can be trimmed up to 12".
- Mini Touch-up Kit (MTUK) included. MTUK includes small touch-up marker and small fill stick.
- For apron front sinks requiring smaller cut-out heights, see Country Sink Base with Short Apron on page 183 or Base Drop-in Range Cabinets on page 213.
- Refer to sink manufacturer's recommendations for additional support required for apron front sinks.

**Custom Modifications**

AUTH	CBO	CCO	CFNTO	CFP	CFRMO	CMAT	CND	DRT	DRWPWR	DRWSEC	DRWTK	EXBK	EX	FB	FD	FFD	FPEB	FTK	FTK_V	ID	INVFRM	LTI	MIP	P	PTOWB	RD	RECTK	RT	SCPDWR	TD	TOTSSS	TVR_V	VTK	WLI	
•	•	•	•	•	•	•*					•*		•	•	•	•	•	•	•	•	•	•	•	•	•	•	•	•	•	•	•	•	•	•	•

\*Available only on 30", 33", and 36" wide    \*Not available on 39", 42", 45", and 48" wide

**Construction Upgrades**

APC	ET	PE
•	•	•

**Door Options**

DPSRR
•

**COUNTRY SINK BASE with CABMAT™**

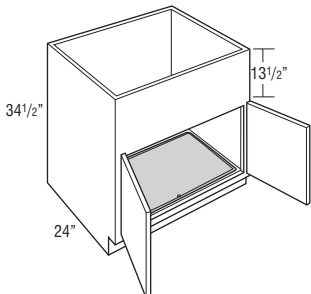

**CNTYSB30CM**

**CNTYSB33CM**

**CNTYSB36CM**

- Mini Touch-up Kit (MTUK) included. MTUK includes small touch-up marker and small fill stick.
- CabMat™ is designed to capture spills and is removable for cleaning.
- 13 1/2" panel can be trimmed to 12".
- For apron front sinks requiring smaller cut-out heights, see Country Sink Base with Short Apron on page 183 or Base Drop-in Range Cabinets on page 213.
- Refer to sink manufacturer's recommendations for additional support required for apron front sinks.

Model	Liquid Capacity		Cabinet Size	
	Gallons	Liters	Width	Depth
CNTYSB30CM	2.0	7.6	30"	24"
CNTYSB33CM	2.4	9.0	33"	24"
CNTYSB36CM	2.7	10.2	36"	24"

**Custom Modifications**

AUTH	CBO	CCO	CFNTO	CFP	CFRMO	CMAT	CND	DRT	DRWPWR	DRWSEC	DRWTK	EXBK	EX	FB	FD	FFD	FPEB	FTK	FTK_V	ID	INVFRM	LTI	MIP	P	PTOWB	RD	RECTK	RT	SCPDWR	TD	TOTSSS	TVR_V	VTK	WLI
•	•	•	•	•	•	STD					•	•	•	•	•	•	•	•	•	•	•	•	•	•	•	•	•	•	•	•	•	•	•	•

**Construction Upgrades**

APC	ET	PE
•	•	•

**Door Options**

DPSRR
•

**NEW** COUNTRY SINK BASE,  
27" DEEP

30", 33", or 36"

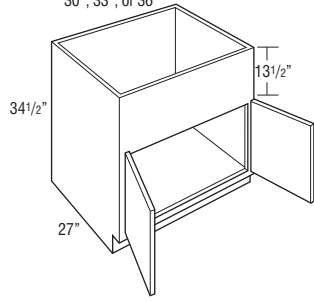

39", 42", 45", or 48"

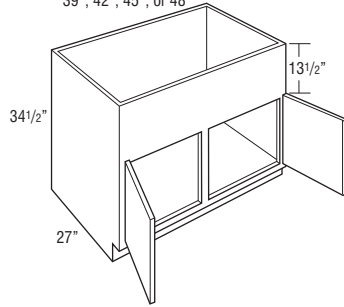

48"

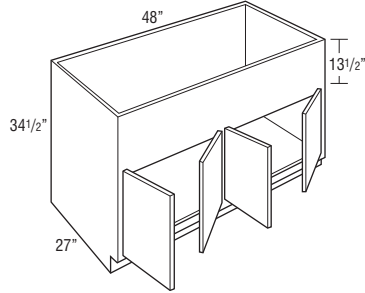

CNTYSB303427  
CNTYSB333427  
CNTYSB363427

CNTYSB393427  
CNTYSB423427  
CNTYSB453427  
CNTYSB483427CS

**CNTYSB483427**

- 13 1/2" panel can be trimmed up to 12".
- Mini Touch-up Kit (MTUK) included. MTUK includes small touch-up marker and small fill stick.
- For apron front sinks requiring smaller cut-out heights, see Country Sink Base with Short Apron on page 183 or Base Drop-in Range Cabinets on page 213.
- Refer to sink manufacturer's recommendations for additional support required for apron front sinks.

**Custom Modifications**

AUTH	CBO	CCO	CFNTO	CFP	CFRMO	CMAT	CND	DRT	DRWPWR	DRWSEC	DRWTK	EXBK	EX	FB	FD	FFD	FPEB	FTK	FTK_V	ID	INVERM	LTI	MIP	P	PTOWB	RD	RECTK	RT	SCPDWR	TD	TOTSSS	TVR_V	VTK	WLI	
•	•	•	•	•	•	•	•	•	•	•	•	•	•	•	•	•	•	•	•	•	•	•	•	•	•	•	•	•	•	•	•	•	•	•	•

**Construction Upgrades**

APC	ET	PE
•	•	•

**Door Options**

DPSRR
•

**COUNTRY SINK BASE with SHORT APRON**

**CNTYSB30SA**  
**CNTYSB33SA**  
**CNTYSB36SA**

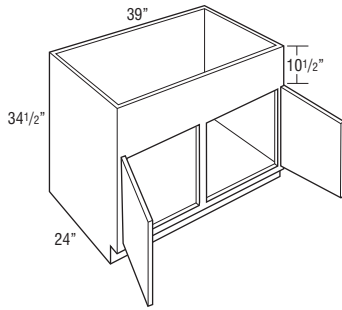
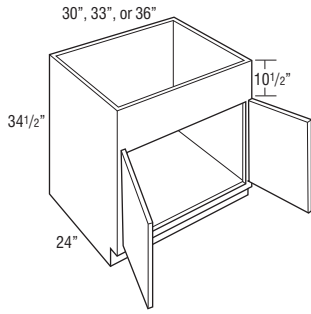

**CNTYSB39SA**

- 10 1/2" panel can be trimmed up to 9".
- Mini Touch-up Kit (MTUK) included. MTUK includes small touch-up marker and small fill stick.
- For apron front sinks requiring a cut-out height of 6 1/2" or less, see Base Drop-in Range Cabinets on page 213.
- Refer to sink manufacturer's recommendations for additional support required for apron front sinks.

**Custom Modifications**

AUTH	CBO	CCO	CFNTO	CFP	CFRMO	CMAT	CND	DRT	DRWPPWR	DRWSEC	DRWTK	EXBK	EX	FB	FD	FFD	FPEB	FTK	FTK_V	ID	INVFRM	LTI	MIP	P	PTOWB	RD	RECTK	RT	SCPDRW	TD	TOTSSS	TVR_V	VTK	WLI	
•	•	•	•	•	•	•*					•*	•	•	•	•	•	•	•	•	•	•	•	•	•	•	•	•	•	•	•	•	•	•	•	•

\*Not available on 39" wide

**Construction Upgrades**

APC	ET	PE
•	•	•

**Door Options**

DPSRR
•

**NEW COUNTRY SINK BASE with SHORT APRON, 27" DEEP**

**CNTYSB303427SA**  
**CNTYSB333427SA**  
**CNTYSB363427SA**

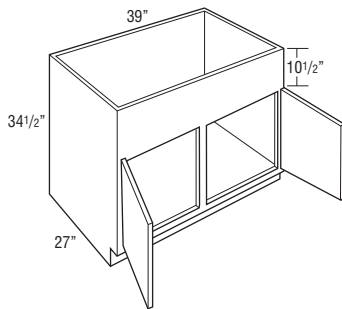
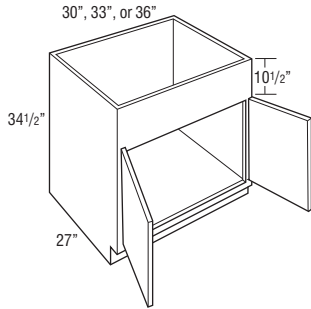

**CNTYSB393427SA**

- 10 1/2" panel can be trimmed up to 9".
- Mini Touch-up Kit (MTUK) included. MTUK includes small touch-up marker and small fill stick.
- For apron front sinks requiring a cut-out height of 6 1/2" or less, see Base Drop-in Range Cabinets on page 213.
- Refer to sink manufacturer's recommendations for additional support required for apron front sinks.

**Custom Modifications**

AUTH	CBO	CCO	CFNTO	CFP	CFRMO	CMAT	CND	DRT	DRWPPWR	DRWSEC	DRWTK	EXBK	EX	FB	FD	FFD	FPEB	FTK	FTK_V	ID	INVFRM	LTI	MIP	P	PTOWB	RD	RECTK	RT	SCPDRW	TD	TOTSSS	TVR_V	VTK	WLI	
•	•	•	•	•	•	•						•	•	•	•	•	•	•	•	•	•	•	•	•	•	•	•	•	•	•	•	•	•	•	•

**Construction Upgrades**

APC	ET	PE
•	•	•

**Door Options**

DPSRR
•

### Sink Base Corner Cabinets

- SBCs use the wall space the nomenclature implies.
- Remember to use 3" filler on adjoining cabinets.
- The adjoining run of cabinets will cover the void.
- The L or R in the cabinet nomenclature indicates the location of the void to ensure clearance.
- It is not recommended to place SBC cabinets next to appliances where any face component is deeper than 27".

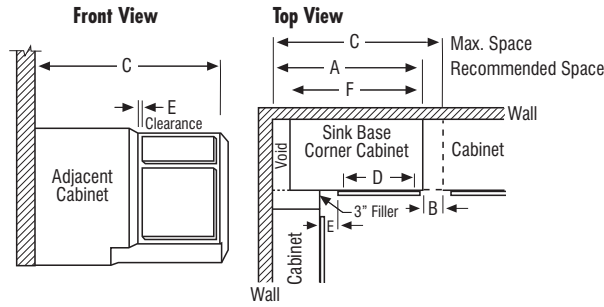

Model	A Recommended Space	B Max. Pull*	C Max. Space	D Face Frame Opening	E* Full Overlay At Min.**	At Max.	F Actual Cabinet
SBC51	51"	4 1/2"	55 1/2"	21"	3 1/4"	7 3/4"	48"
SBC54	54"	4 1/2"	58 1/2"	24"	3 1/4"	7 3/4"	51"
SBC57	57"	4 1/2"	61 1/2"	27"	3 1/4"	7 3/4"	54"
SBC60	60"	4 1/2"	64 1/2"	30"	3 1/4"	7 3/4"	57"
SBC63	63"	4 1/2"	67 1/2"	33"	3 1/4"	7 3/4"	60"

\*Minimum/maximum space between inside edge of door and face of filler/adjoining cabinet. If cabinet is pulled to maximum stated dimension, filler will need to be created for proper attachment.

\*\*When using hardware on cabinet doors/drawers, additional clearance may be needed.

### SINK BASE CORNER

#### SBC51 L or R

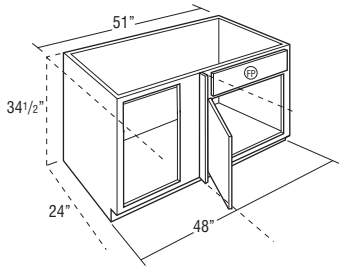

#### SBC54 L or R

#### SBC57 L or R

#### SBC60 L or R

#### SBC63 L or R

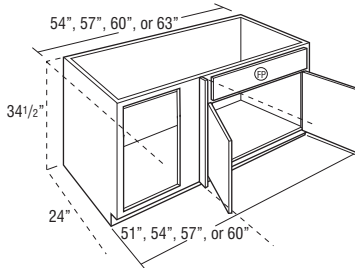

- On void side, do not install next to an appliance deeper than standard cabinet depth due to clearance needed for the door.
- Includes one 3" filler, shipped unattached.
- L or R indicates void. L (left) void shown.
- Mini Touch-up Kit (MTUK) included. MTUK includes small touch-up marker and small fill stick.

	Sink Base Frame Opening Width	Sink Base Cabinet Equivalent Width	# of Doors	Full Overlay Door Size	
				Width	Height
SBC51	21"	24"	1	23 1/2"	23"
SBC54	24"	27"	2	13 3/16"	23"
SBC57	27"	30"	2	14 11/16"	23"
SBC60	30"	33"	2	16 3/16"	23"
SBC63	33"	36"	2	17 11/16"	23"

#### Custom Modifications

AUTH	CBO	CCO	CFNTO	CFP	CFRMO	CMAT	CND	DRT	DRWPWR	DRWSEC	DRWTK	EXBK	EX	FB	FD	FFD	FPEB	FTK	FTK_V	ID	INVMFR	LTI	MIP	P	PTOWB	RD	RECTK	RT	SCPDRW	TD	TOTSSS	TVR	V	VTK	WLI
•	•	•	•	•	•	•	•	•	•	•	•	•	•	•	•	•	•	•	•	•	•	•	•	•	•	•	•	•	•	•	•	•	•	•	•

\*Face Frame and Door on End modification not available on the void side of the cabinet.

#### Construction Upgrades

APC	ET	PE
•	•	•

#### Door Options

DPSRR
•

**Base Corner Cabinets**

- BCs use the wall space the nomenclature implies.
- Remember to use 3" filler on adjoining cabinets.
- The adjoining run of cabinets will cover the void.
- BCFW specifies full width base corner cabinet.
- The L or R in the cabinet nomenclature indicates the location of the void to ensure clearance.
- It is not recommended to place BC cabinets next to appliances where any face component is deeper than 27".

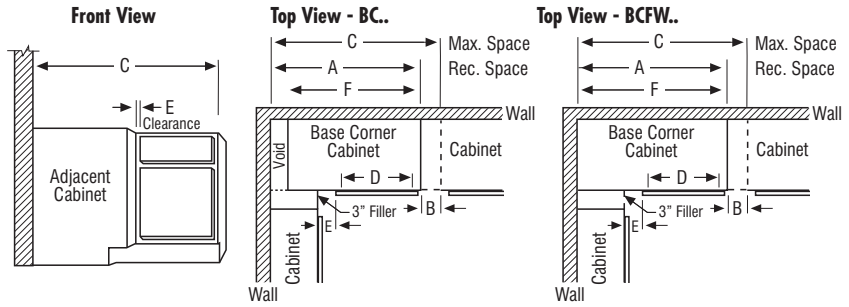

Model	A Recommended Space	B Max. Pull*	C Max. Space	D Face Frame Opening	E* Full Overlay At Min.** At Max.		F Actual Cabinet	Full Overlay Door Width
BC36	36"	6"	42"	7 1/2"	1 3/4"	7 3/4"	27"	10"
BC39	39"	4 1/2"	43 1/2"	9"	3 1/4"	7 3/4"	30"	11 1/2"
BC42	42"	6"	48"	13 1/2"	1 3/4"	7 3/4"	39"	16"
BC45/BC45PO	45"	4 1/2"	49 1/2"	15"	3 1/4"	7 3/4"	42"	17 1/2"
BC48/BC48PO	48"	3"	51"	16 1/2"	4 3/4"	7 3/4"	45"	19"
BCFW36/BCFW36FH	36"	5"	41"	7 1/2"	1 3/4"	6 3/4"	36"	10"
BCFW39/BCFW39FH	39"	3 1/2"	42 1/2"	9"	3 1/4"	6 3/4"	39"	11 1/2"
BCFW42/BCFW42FH	42"	9"	51"	13 1/2"	1 3/4"	10 3/4"	42"	16"
BCFW45/BCFW45FH/BCFW45PO	45"	7 1/2"	52 1/2"	15"	3 1/4"	10 3/4"	45"	17 1/2"
BCFW48/BCFW48CPO/BCFW48FH/BCFW48PO	48"	4 1/2"	52 1/2"	18"	3 1/4"	7 3/4"	48"	20 1/2"
BCFW48SP	48"	4 1/2"	52 1/2"	18"	3 1/4"	7 3/4"	48"	20 1/2"

\*Minimum/maximum space between inside edge of door and face of filler/adjoining cabinet. If cabinet is pulled to maximum stated dimension, filler will need to be cleated for proper attachment.  
 \*\*When using hardware on cabinet doors/drawers, additional clearance may be needed.

**BASE CORNER**

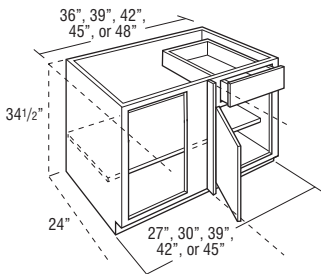

- BC36 L or R**
- BC39 L or R**
- BC42 L or R**
- BC45 L or R**
- BC48 L or R**

- On void side, do not install next to an appliance deeper than standard cabinet depth due to clearance needed for the door and drawer.
- Includes one 3" filler, shipped unattached.
- L or R indicates void. L (left) void shown.
- Adjustable 15" deep shelves.

**Custom Modifications**

AUTH	CBO	CCO	CFNTO	CFP	CFRMO	CMAT	CND	DRT	DRWPWR	DRWSEC	DRWTK	EXBK	EX	FB	FD	FFD	FPFB	FTK	FTK_V	ID	INVFRM	LTI	MIP	P	PTOWB	RD	RECTK	RT	SCPDWR	TD	TOTSSS	TVR_V	VTK	WLI	
•	•	•	•	•	•	•	•	•	•*	•*	•	•	•	•	•	•	•	•	•	•	•	•	•	•	•	•	•	•	•	•	•	•	•	•	•

\*Not available on 36", 39", and 42" wide    \*Available only on 45" wide    ^Face Frame and Door on End modification not available on the void side of the cabinet.    †Not available on 36" and 39" wide

**Construction Upgrades**

APC	ET	PE
•	•	•

**Door Options**

DPSRR
•

**BASE CORNER with PULL-OUT**

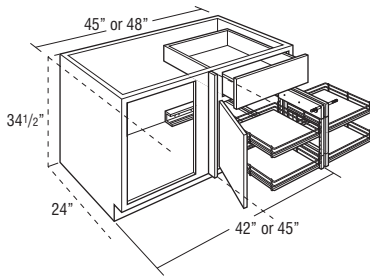

**BC45PO L or R**  
**BC48PO L or R**

- On pull-out side of cabinet, do not install next to a wall or appliance due to clearance needed for pull-out to come out of cabinet. On void side, do not install next to an appliance deeper than standard cabinet depth due to clearance needed for door to open fully to allow pull-out to be used and also for the drawer to open fully.
- Pull-out features four wood shelves with chrome surround. Smart close not available.
- Includes one 3" filler, shipped unattached.
- L or R indicates void. L (left) void shown.
- Adjacent cabinet hardware may interfere with shelf position on pull-out.
- Wire pull-out dimensions are 10 5/8" W x 17 1/8" D x 2 3/4" H.
- For pull-out to open, 10" of adjacent space is required with no obstruction beyond 1" in front of the cabinet face frame.

**Custom Modifications**

AUTH	CBO	CCO	CFNT0	CFP	CFRMO	CMAT	CND	DRT	DRWPWR	DRWSEC	DRWTK	EXBK	EX	FB	FD	FFD	FPEB	FTK	FTK_V	ID	INVRM	LTI	MIP	P	PTOWB	RD	RECTK	RT	SCDRW	TD	TOTSSS	TVR_V	VTK	WLI	
•	•	•	•	•	•	•	•	•	•	•	•	•	•	•	•	•	•	•	•	•	•	•	•	•	•	•	•	•	•	•	•	•	•	•	•

**Construction Upgrades**

APC	ET	PE
•	•	•

**Door Options**

DPSRR
•

**BASE CORNER FULL WIDTH**

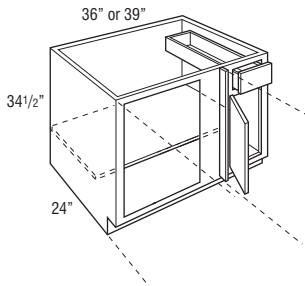

**BCFW36 L or R**  
**BCFW39 L or R**

**BCFW42 L or R**  
**BCFW45 L or R**  
**BCFW48 L or R**

- On void side, do not install next to an appliance deeper than standard cabinet depth due to clearance needed for the door and drawer.
- Includes one 3" filler, shipped unattached.
- L or R indicates void. L (left) void shown.
- Adjustable 15" deep shelves.

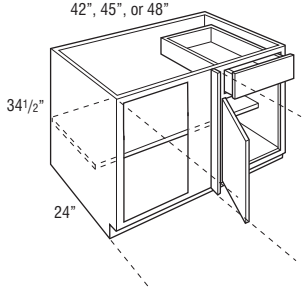

**Custom Modifications**

AUTH	CBO	CCO	CFNT0	CFP	CFRMO	CMAT	CND	DRT	DRWPWR	DRWSEC	DRWTK	EXBK	EX	FB	FD	FFD	FPEB	FTK	FTK_V	ID	INVRM	LTI	MIP	P	PTOWB	RD	RECTK	RT	SCDRW	TD	TOTSSS	TVR_V	VTK	WLI	
•	•	•	•	•	•	•	•	•	•*	•*	•	•	•	•	•	•	•	•	•	•	•	•	•	•	•	•	•	•	•	•	•	•	•	•	•

\*Not available on 36", 39", and 42" wide    \*Available only on 45" and 48" wide    \*Face Frame and Door on End modification not available on the void side of the cabinet.    †Not available on 36" and 39" wide

**Construction Upgrades**

APC	ET	PE
•	•	•

**Door Options**

DPSRR
•



**BASE CORNER FULL WIDTH, FULL HEIGHT**

36", 39", 42", 45", or 48"

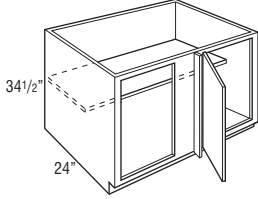

- BCFW36FH L or R**
- BCFW39FH L or R**
- BCFW42FH L or R**
- BCFW45FH L or R**
- BCFW48FH L or R**

- On void side, do not install next to an appliance deeper than standard cabinet depth due to clearance needed for the door.
- Includes one 3" filler, shipped unattached.
- L or R indicates void. L (left) void shown.
- Adjustable 15" deep shelves.

**Custom Modifications**

AUTH	CBO	CCO	CFNTO	CFP	CFRMO	CMAT	CND	DRT	DRWPWR	DRWSEC	DRWTK	EXBK	EX	FB	FD	FFD	FPEB	FTK	FTK_V	ID	INVFRM	LTI	MIP	P	PTOWB	RD	RECTK	RT	SCPDRW	TD	TOTSSS	TVR_V	VTK	WLI	
•	•	•	•	•	•							•	•	•	•	•*	•						•+	•			•	•						•	•

\*Face Frame and Door on End modification not available on the void side of the cabinet. +Not available on 36" and 39" wide

**Construction Upgrades**

APC	ET	PE
•		•

**Door Options**

DPSRR
•

**BASE CORNER FULL WIDTH with CURVED PULL-OUT**

48"

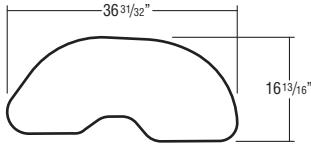
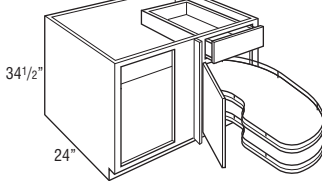

**BCFW48CPO L or R**

- On void side, do not install next to an appliance deeper than standard cabinet depth due to clearance needed for the door and drawer.
- Includes one 3" filler, shipped unattached.
- Includes two pull-out shelves with chrome wire surround and smart close closing mechanism. Shelf height can be adjusted in the field.
- When shelf is fully opened, it extends 27 3/4" from front edge of the face frame. Unit pulls out to the front only and can be installed next to a wall or appliance without side interference.
- Distance from surface of shelf to top edge of wire surround is 1 11/16".
- L or R indicates void. L (left) void shown.
- Maximum Weight Capacity: 44 lbs. per shelf.

**Custom Modifications**

AUTH	CBO	CCO	CFNTO	CFP	CFRMO	CMAT	CND	DRT	DRWPWR	DRWSEC	DRWTK	EXBK	EX	FB	FD	FFD	FPEB	FTK	FTK_V	ID	INVFRM	LTI	MIP	P	PTOWB	RD	RECTK	RT	SCPDRW	TD	TOTSSS	TVR_V	VTK	WLI	
•	•	•	•	•	•							•	•	•	•	•	•							•	•			•	•					•	•

**Construction Upgrades**

APC	ET	PE
•		•

**Door Options**

DPSRR
•

**BASE CORNER FULL WIDTH with PULL-OUT**

45" or 48"

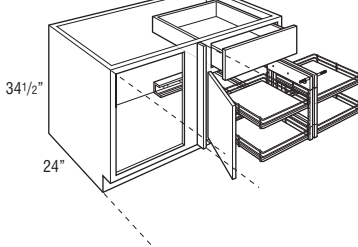

**BCFW45PO L or R**  
**BCFW48PO L or R**

- On pull-out side of cabinet, do not install next to a wall or appliance due to clearance needed for pull-out to come out of cabinet. On void side, do not install next to an appliance deeper than standard cabinet depth due to clearance needed for door to open fully to allow pull-out to be used and also for the drawer to open fully.
- Includes one 3" filler, shipped unattached.
- L or R indicates void. L (left) void shown.
- Pull-out features four wood shelves with chrome surround. Smart close not available.
- Wire pull-out interior dimensions are 10 5/8" W x 17 1/8" D x 2 3/4" H.
- For pull-out to open, 10" of adjacent space is required with no obstruction beyond 1" in front of the cabinet face frame.
- Adjacent cabinet hardware may interfere with shelf position on pull-out.

**Custom Modifications**

AUTH	CBO	CCO	CFNTO	CFP	CFRMO	CMAT	CND	DRT	DRWPWR	DRWSEC	DRWTK	EXBK	EX	FB	FD	FFD	FPEB	FTK	FTK_V	ID	INVFRM	LTI	MIP	P	PTOWB	RD	RECTK	RT	SCPDRW	TD	TOTSSS	TVR_V	VTK	WLI	
•	•	•	•	•	•							•	•	•	•	•	•							•	•			•	•					•	•

**Construction Upgrades**

APC	ET	PE
•		•

**Door Options**

DPSRR
•

## BASE CORNER FULL WIDTH with ROLL TRAYS & SWING-OUT

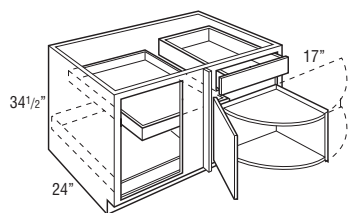

### BCFW48SP L or R

- On swing-out side of cabinet, do not install next to a wall or appliance due to clearance needed for swing-out to come out of cabinet and allow full access to other contents inside of cabinet. On void side, do not install next to an appliance deeper than standard cabinet depth due to clearance needed for door to open fully to allow swing-out to be used and also for the drawer to open fully.
- Includes one 3" filler, shipped unattached.
- L or R indicates void. L (left) void shown.
- Swing-out hinged opposite door.
- Roll trays and swing-outs installed.
- Insert swing on a base corner full width cabinet is 17".
- Swing-out is 3/4" laminated furniture board.

188

#### Custom Modifications

AUTH	CBO	CCO	CFNTO	CFP	CFRMO	CNAT	CND	DRT	DRWPWR	DRWSEC	DRWTK	EXBK	EX	FB	FD	FFD	FPEB	FTK	FTK_V	ID	INVFRM	LTI	MIP	P	PTOWB	RD	RECTK	RT	SCPDRW	TD	TOTSSS	TVR_V	VTK	WLI	
•	•	•	•	•	•	•	•	•	•	•	•	•	•	•	•	•	•	•	•	•	•	•	•	•	•	•	•	•	•	•	•	•	•	•	•

#### Construction Upgrades

APC	ET	PE
•	•	•

#### Door Options

DPSRR
•

BASE CABINETS

**BASE LAZY SUSAN CORNER with FULL HEIGHT DOOR and LAZY SUSAN (With Center Hinge Door)**

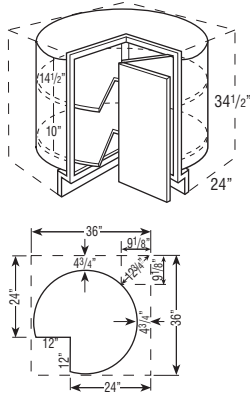

**BLS36 L or R**

- BLS36 L or R wall width is 36" x 36".
- Cabinet is drum-shaped; adjoining cabinets create sides.
- BLS white plastic shelves are 28" diameter with a chrome pole.
- See Panels & Skins section for BLS BEP if used at end of cabinet run.
- If ordered with PE or APC, construction and price will not change.
- Drum diameter is 31 1/8" and composed of 1/8" thick hardboard.
- Decorative hardware screws must be countersunk to prevent scratching of adjacent cabinets and face frame of BLS.
- Integrated soft-close hinge not included.

**Custom Modifications**

AUTH	CBO	CCO	CFNTO	CFP	CFRMO	CMAT	CND	DRT	DRWPWR	DRWSEC	DRWTK	EXBK	EX	FB	FD	FFD	FPEB	FTK	FTK_V	ID	INVFRM	LTI	MIP	P	PTOWB	RD	RECTK	RT	SCPDRW	TD	TOTSSS	TVR_V	VTK	WLI			

**Construction Upgrades**

APC	ET	PE

**Door Options**

DPSRR

**DIAGONAL BASE with FULL HEIGHT DOOR**

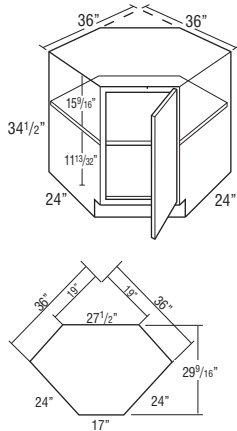

**DAB36FS L or R**

- One fixed 1/2" thick shelf.
- Full overlay styles use 14 1/2" wide doors with 38NPOHINGE to allow for proper door clearance with adjacent cabinets.

**Custom Modifications**

AUTH	CBO	CCO	CFNTO	CFP	CFRMO	CMAT	CND	DRT	DRWPWR	DRWSEC	DRWTK	EXBK	EX	FB	FD	FFD	FPEB	FTK	FTK_V	ID	INVFRM	LTI	MIP	P	PTOWB	RD	RECTK	RT	SCPDRW	TD	TOTSSS	TVR_V	VTK	WLI			

**Construction Upgrades**

APC	ET	PE

**Door Options**

DPSRR

**DIAGONAL BASE with FULL HEIGHT DOOR & SUPER LAZY SUSAN**

**DAB36SLS L or R**

- Features two 28" plywood susans with a 1" plywood lip. Lower susan is mounted to floor. Upper susan is mounted to fixed shelf. Fixed shelf is 1/2" thick laminated furniture board.
- Full overlay styles use 14 1/2" wide doors with 38NPOHINGE to allow for proper door clearance with adjacent cabinets.

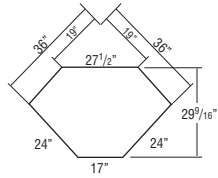
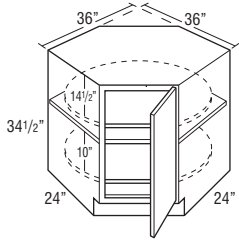

Due to fixed shelf mounting, susans cannot be retrofitted.

**Custom Modifications**

AUTH	CBO	CCO	CFNTO	CFP	CFRMO	CMAT	CND	DRT	DRWPWR	DRWSEC	DRWTK	EXBK	EX	FB	FD	FFD	FPEB	FTK	FTK_V	ID	INVFRM	LTI	MIP	P	PTOWB	RD	RECTK	RT	SCPDWR	TD	TOTSSS	TVR	V	VTK	WLI		
•	•	•	•	•	•	•	•	•	•	•	•	•	•	•	•	•	•	•	•	•	•	•	•	•	•	•	•	•	•	•	•	•	•	•	•	•	•

**Construction Upgrades**

APC	ET	PE
•	•	•

**Door Options**

DPSRR
•

**BASE EASY REACH**

**BER33 L or R**

**BER36 L or R**

- BER33 L or R wall width is 33" x 33". BER36 L or R wall width is 36" x 36".
- Decorative hardware screws must be countersunk to prevent scratching of adjacent cabinets and face frame of BER.
- Fixed shelf is 1/2" thick laminated furniture board.
- Integrated soft-close hinge not included.

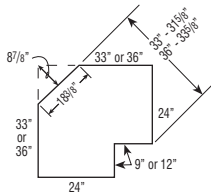
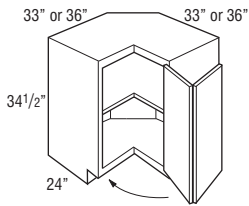

**Custom Modifications**

AUTH	CBO	CCO	CFNTO	CFP	CFRMO	CMAT	CND	DRT	DRWPWR	DRWSEC	DRWTK	EXBK	EX	FB	FD	FFD	FPEB	FTK	FTK_V	ID	INVFRM	LTI	MIP	P	PTOWB	RD	RECTK	RT	SCPDWR	TD	TOTSSS	TVR	V	VTK	WLI		
•	•	•	•	•	•	•	•	•	•	•	•	•	•	•	•	•	•	•	•	•	•	•	•	•	•	•	•	•	•	•	•	•	•	•	•	•	•

**Construction Upgrades**

APC	ET	PE
•	•	•

**Door Options**

DPSRR
•

**BASE EASY REACH with ADJUSTABLE SHELVES**

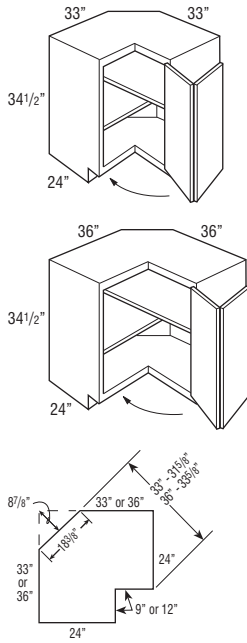

**BERAS33 L or R**  
**BERAS36 L or R**

- BERAS33 L or R wall width is 33" x 33". BERAS36 L or R wall width is 36" x 36".
- Decorative hardware screws must be countersunk to prevent scratching of adjacent cabinets and face frame of BERAS.
- Adjustable crisscross shelves.
- Integrated soft-close hinge not included.

**Custom Modifications**

AUTH	CBO	CCO	CFNTO	CFP	CFRMO	CMAT	CND	DRT	DRWPWR	DRWSEC	DRWTK	EXBK	EX	FB	FD	FFD	FPEB	FTK	FTK_V	ID	INVFRM	LTI	MIP	P	PTOWB	RD	RECTK	RT	SCPDRW	TD	TOTSSS	TVR_V	VTK	WLI	
•	•	•												•			•						•	•			•							•	•

**Construction Upgrades**

APC	ET	PE
•		•

**Door Options**

DPSRR
•

**ASYMMETRICAL BASE EASY REACH**

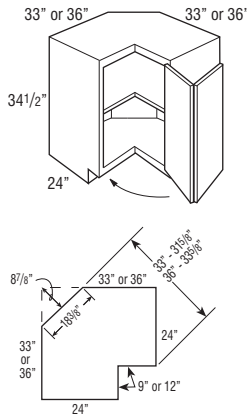

**BER3336 L or R**  
**BER3633 L or R**

- BER3336 L or R wall width is 33" x 36".
- BER3633 L or R wall width is 36" x 33".
- Legs at the front frames are 9" on 33" and 12" on 36" leg.
- Nomenclature for asymmetrical cabinets reads as follows:  
First set of numbers = left side of cabinet dimensions.  
Second set of numbers = right side of cabinet dimensions.
- Decorative hardware screws must be countersunk to prevent scratching of adjacent cabinets and face frame of BER.
- Fixed shelf is 1/2" thick laminated furniture board.
- Integrated soft-close hinge not included.

**Custom Modifications**

AUTH	CBO	CCO	CFNTO	CFP	CFRMO	CMAT	CND	DRT	DRWPWR	DRWSEC	DRWTK	EXBK	EX	FB	FD	FFD	FPEB	FTK	FTK_V	ID	INVFRM	LTI	MIP	P	PTOWB	RD	RECTK	RT	SCPDRW	TD	TOTSSS	TVR_V	VTK	WLI	
•	•	•												•			•						•	•			•							•	•

**Construction Upgrades**

APC	ET	PE
•		•

**Door Options**

DPSRR
•

### ASYMMETRICAL BASE EASY REACH with ADJUSTABLE SHELVES

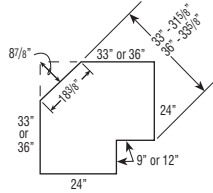
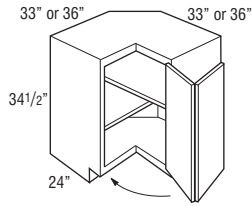

### BERAS3336 L or R BERAS3633 L or R

- BERAS3336 L or R wall width is 33" x 36".
- BERAS3633 L or R wall width is 36" x 33".
- Legs at the front frames are 9" on 33" and 12" on 36" leg.
- Nomenclature for asymmetrical cabinets reads as follows:  
First set of numbers = left side of cabinet dimensions.  
Second set of numbers = right side of cabinet dimensions.
- Decorative hardware screws must be countersunk to prevent scratching of adjacent cabinets and face frame of BERAS.
- Adjustable crisscross shelves.
- Integrated soft-close hinge not included.

**Custom Modifications**

AUTH	CBO	CCO	CFNTO	CFP	CFRMO	CMAI	CND	DRT	DRWPWR	DRWSEC	DRWTK	EXBK	EX	FB	FD	FFD	FPEB	FTK	FTK V	ID	INVFRM	LTI	MIP	P	PTOWB	RD	RECTK	RT	SCPRW	TD	TOTSSS	TVR	V	VTK	WLI	
•	•	•												•			•						•	•				•							•	•

**Construction Upgrades**

APC	ET	PE
•		•

**Door Options**

DPSRR
•

### SUPER LAZY SUSAN

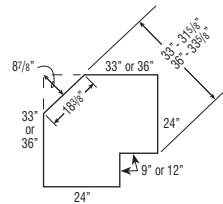
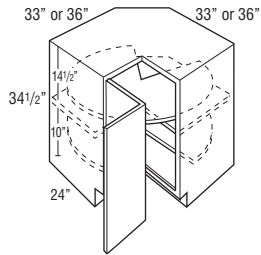

Due to fixed shelf mounting, susans cannot be retrofitted.

### SLS33 L or R SLS36 L or R

- SLS33 L or R wall width is 33" x 33".
- SLS36 L or R wall width is 36" x 36".
- SLS33 - Susans are 28" diameter.
- SLS36 - Susans are 32" diameter.
- Features two plywood susans with a 1" plywood lip. Lower susan is mounted to floor. Upper susan is mounted to fixed shelf. Fixed shelf is 1/2" thick laminated furniture board.
- Decorative hardware screws must be countersunk to prevent scratching adjacent cabinets and face frame of SLS.
- Integrated soft-close hinge not included.

**Custom Modifications**

AUTH	CBO	CCO	CFNTO	CFP	CFRMO	CMAI	CND	DRT	DRWPWR	DRWSEC	DRWTK	EXBK	EX	FB	FD	FFD	FPEB	FTK	FTK V	ID	INVFRM	LTI	MIP	P	PTOWB	RD	RECTK	RT	SCPRW	TD	TOTSSS	TVR	V	VTK	WLI	
•														•			•						•	•				•							•	•

**Construction Upgrades**

APC	ET	PE
•		•

**Door Options**

DPSRR
•

**SOLID-WOOD SUPER LAZY SUSAN**

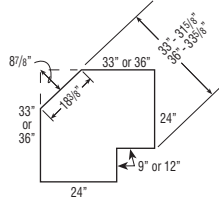
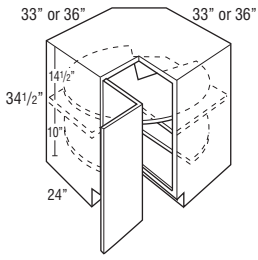

Due to fixed shelf mounting, susans cannot be retrofitted.

**Custom Modifications**

AUTH	CBO	CCO	CFNTO	CFP	CFRMO	CMAT	CND	DRT	DRWPWR	DRWSEC	DRWTK	EXBK	EX	FB	FD	FFD	FPEB	FTK	FTK_V	ID	INVFRM	LTI	MIP	P	PTOWB	RD	RECTK	RT	SCPDWR	TD	TOTSSS	TVR_V	VTK	WLI			

**Construction Upgrades**

APC	ET	PE

**Door Options**

DPSRR

**SLSW33 L or R**

**SLSW36 L or R**

- SLSW33 L or R wall width is 33" x 33".
- SLSW36 L or R wall width is 36" x 36".
- SLSW33 L or R - Susans are 28" diameter.
- SLSW36 L or R - Susans are 32" diameter.
- Features two hardwood susans with a 3/16" lip. Lower susan is mounted to floor. Upper susan is mounted to fixed shelf. Fixed shelf is 1/2" thick laminated furniture board.
- Decorative hardware screws must be countersunk to prevent scratching adjacent cabinets and face frame of SLS.
- Integrated soft-close hinge not included.

**SUPER LAZY SUSAN with CHROME RAIL**

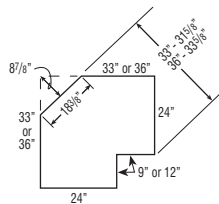
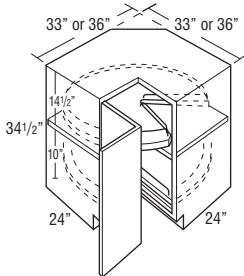

Due to fixed shelf mounting, susans cannot be retrofitted.

**Custom Modifications**

AUTH	CBO	CCO	CFNTO	CFP	CFRMO	CMAT	CND	DRT	DRWPWR	DRWSEC	DRWTK	EXBK	EX	FB	FD	FFD	FPEB	FTK	FTK_V	ID	INVFRM	LTI	MIP	P	PTOWB	RD	RECTK	RT	SCPDWR	TD	TOTSSS	TVR_V	VTK	WLI			

**Construction Upgrades**

APC	ET	PE

**Door Options**

DPSRR

**SLSR33 L or R**

**SLSR36 L or R**

- SLSR33 L or R wall width is 33" x 33". SLSR36 L or R wall width is 36" x 36".
- SLSR33 - Susans are 28" diameter. SLSR36 - Susans are 32" diameter.
- Features two plywood susans with a 1" plywood lip. Lower susan is mounted to floor. Upper susan is mounted to fixed shelf. Fixed shelf is 1/2" thick laminated furniture board.
- Chrome rail surrounds both susans. Chrome rail height is 2 13/16".
- Decorative hardware screws must be countersunk to prevent scratching adjacent cabinets and face frame of SLSR.
- Integrated soft-close hinge not included.

**ASYMMETRICAL SUPER LAZY SUSAN**

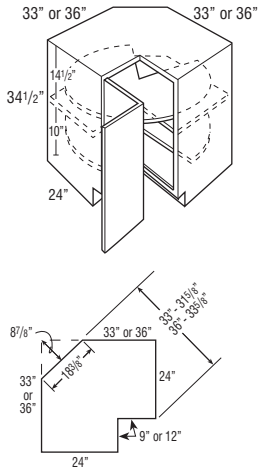

Due to fixed shelf mounting, susans cannot be retrofitted.

**Custom Modifications**

AUTH	CBO	CCO	CFNTO	CFP	CFRMO	CMAT	CND	DRT	DRWPWR	DRWSEC	DRWTK	EXBK	EX	FB	FD	FFD	FPEB	FTK	FTK_V	ID	INVFRM	LTI	MIP	P	PTOWB	RD	RECTK	RT	SCPDWR	TD	TOTSSS	TVR	V	VTK	WLI			

**Construction Upgrades**

APC	ET	PE

**Door Options**

DPSRR

**SLS3336 L or R**  
**SLS3633 L or R**

- SLS3336 L or R wall width is 33" x 36".
- SLS3633 L or R wall width is 36" x 33".
- All Asymmetrical Super Susan shelves are 28" diameter.
- Features two plywood susans with a 1" plywood lip. Lower susan is mounted to floor. Upper susan is mounted to fixed shelf. Fixed shelf is 1/2" thick laminated furniture board.
- Nomenclature for asymmetrical cabinets reads as follows:  
First set of numbers = left side of cabinet dimensions.  
Second set of numbers = right side of cabinet dimensions.
- Decorative hardware screws must be countersunk to prevent scratching adjacent cabinets and face frame of SLS.
- Integrated soft-close hinge not included.

**ASYMMETRICAL SOLID-WOOD SUPER LAZY SUSAN**

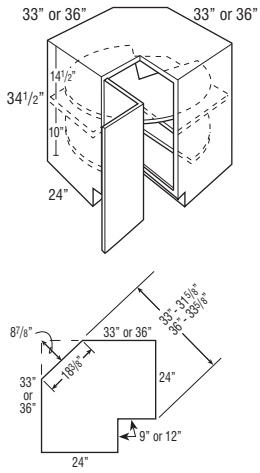

Due to fixed shelf mounting, susans cannot be retrofitted.

**Custom Modifications**

AUTH	CBO	CCO	CFNTO	CFP	CFRMO	CMAT	CND	DRT	DRWPWR	DRWSEC	DRWTK	EXBK	EX	FB	FD	FFD	FPEB	FTK	FTK_V	ID	INVFRM	LTI	MIP	P	PTOWB	RD	RECTK	RT	SCPDWR	TD	TOTSSS	TVR	V	VTK	WLI			

**Construction Upgrades**

APC	ET	PE

**Door Options**

DPSRR

**SLSW3336 L or R**  
**SLSW3633 L or R**

- SLSW3336 L or R wall width is 33" x 36".
- SLSW3633 L or R wall widths is 36" x 33".
- All Asymmetrical Super Susan shelves are 28" diameter.
- Features two hardwood susans with a 3/16" lip. Lower susan is mounted to floor. Upper susan is mounted to fixed shelf. Fixed shelf is 1/2" thick laminated furniture board.
- Nomenclature for asymmetrical cabinets reads as follows:  
First set of numbers = left side of cabinet dimensions.  
Second set of numbers = right side of cabinet dimensions.
- Decorative hardware screws must be countersunk to prevent scratching adjacent cabinets and face frame of SLS.
- Integrated soft-close hinge not included.



**ASYMMETRICAL SUPER LAZY SUSAN with CHROME RAIL**

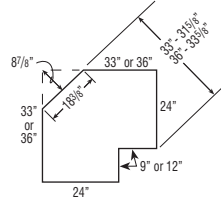
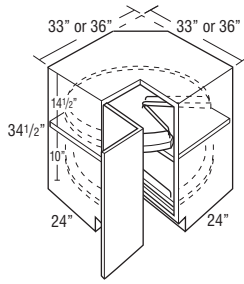

Due to fixed shelf mounting, susans cannot be retrofitted.

**Custom Modifications**

AUTH	CBO	CCO	CFNTO	CFP	CFRMO	CMAT	CND	DRT	DRWPWR	DRWSEC	DRWTK	EXBK	EX	FB	FD	FFD	FPEB	FTK	FTK_V	ID	INVFRM	LTI	MIP	P	PTOWB	RD	RECTK	RT	SCPDRW	TD	TOTSSS	TVR_V	VTK	WLI			

**Construction Upgrades**

APC	ET	PE

**Door Options**

DPSRR

**SLSCR3336 L or R**  
**SLSCR3633 L or R**

- SLSCR3336 L or R wall width is 33" x 36".
- SLSCR3633 L or R wall width is 36" x 33".
- All Asymmetrical Super Susan shelves are 28" diameter.
- Features two plywood susans with a 1" plywood lip. Lower susan is mounted to floor. Upper susan is mounted to fixed shelf. Fixed shelf is 1/2" thick laminated furniture board.
- Chrome rail surrounds both susans. Chrome rail height is 2 13/16".
- Nomenclature for asymmetrical cabinets reads as follows:  
First set of numbers = left side of cabinet dimensions.  
Second set of numbers = right side of cabinet dimensions.
- Decorative hardware screws must be countersunk to prevent scratching adjacent cabinets and face frame of SLS.
- Integrated soft-close hinge not included.

**BASE ROTATING DEEP BIN**

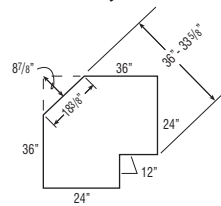
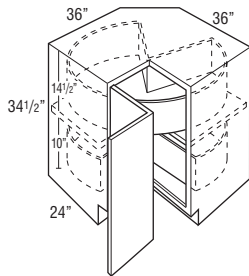

Due to fixed shelf mounting, susans cannot be retrofitted.

**Custom Modifications**

AUTH	CBO	CCO	CFNTO	CFP	CFRMO	CMAT	CND	DRT	DRWPWR	DRWSEC	DRWTK	EXBK	EX	FB	FD	FFD	FPEB	FTK	FTK_V	ID	INVFRM	LTI	MIP	P	PTOWB	RD	RECTK	RT	SCPDRW	TD	TOTSSS	TVR_V	VTK	WLI			

**Construction Upgrades**

APC	ET	PE

**Door Options**

DPSRR

**BRDB36 L or R**

- BRDB36 wall width is 36" x 36".
- BRDB36 susans are 30" diameter. Bins are 6" deep.
- Not available in asymmetrical applications.
- Inside bottom of lower deep susan to the fixed shelf is 10" high.
- Inside bottom of upper deep susan to the bottom of face frame cross rail is 14 1/8" high.
- Lower susan is mounted to floor. Upper susan is mounted to fixed shelf. Fixed shelf is 1/2" thick laminated furniture board.
- Decorative hardware screws must be countersunk to prevent scratching of adjacent cabinets and face frame of BRDB.
- Integrated soft-close hinge not included.

**LAZY SUSAN PULL-OUT**

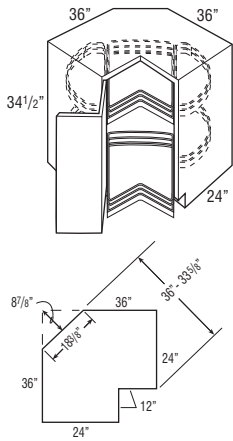

**LSP36 L or R**

- LSP36 L or R wall width is 36" x 36".
- Features four half-moon bins (8 3/8" x 25 1/2" each) with plywood shelves and chrome rail sides.
- Center pull-outs have smart close guides and operate independently. Entire unit rotates when center pull-outs are in closed position.
- Decorative hardware screws must be countersunk to prevent scratching adjacent cabinets and face frame of LSP.
- Integrated soft-close hinge not included.

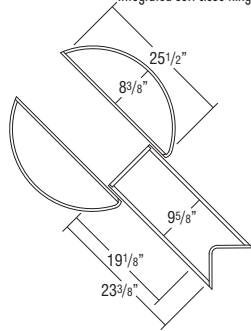

**Custom Modifications**

AUTH	CBO	CCO	CFNT0	CFP	CFRMO	CMAT	CND	DRT	DRWPWR	DRWSEC	DRWTK	EXBK	EX	FB	FD	FFD	FPEB	FTK	FTK_V	ID	INVFRM	LTI	MIP	P	PTOWB	RD	RECTK	RT	SCPRW	TD	TOTSS	TVR_V	VTK	WLI		
•	•											•	•				•																		•	•

**Construction Upgrades**

APC	ET	PE
•		•

**Door Options**

DPSRR
•

**THREE DRAWER CORNER CABINET**

**3CDB36**

- Must be installed between 2 cabinets.
- Allow for proper clearance of drawer head when specifying corner drawer cabinets next to appliances.
- Will have less than 3/4" overlay side reveal for clearance purposes.
- Cabinet sides will always be Natural Maple laminate. If PE or APC is specified, cabinet sides will be unfinished.
- Exterior height of bottom 2 drawer boxes is 7 3/8".

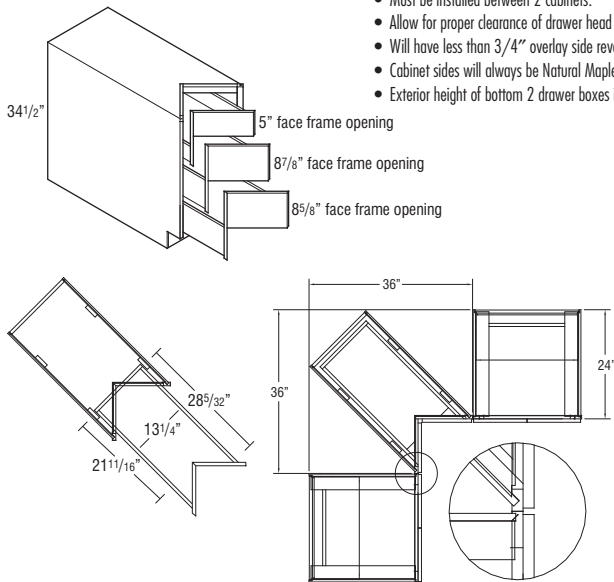

A Dimension	B Dimension
24"*	0"
25"	3/4"
26"	1 3/4"
27"	2 3/4"
28"	3 3/4"
29"	4 3/4"
30"	5 3/4"

A indicates depth of adjacent appliance or cabinet.  
 B indicates minimum space needed between appliance/deeper cabinet and corner drawer base to ensure proper operation of drawers.  
 \*Standard depth cabinet (24") does not require filler.

**Custom Modifications**

AUTH	CBO	CCO	CFNT0	CFP	CFRMO	CMAT	CND	DRT	DRWPWR	DRWSEC	DRWTK	EXBK	EX	FB	FD	FFD	FPEB	FTK	FTK_V	ID	INVFRM	LTI	MIP	P	PTOWB	RD	RECTK	RT	SCPRW	TD	TOTSS	TVR_V	VTK	WLI	
•	•																																		•

**Construction Upgrades**

APC	ET	PE
•		•

**Door Options**

DPSRR
•

**BASE TRANSITION CABINET**

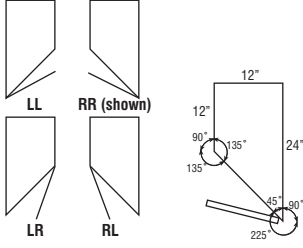
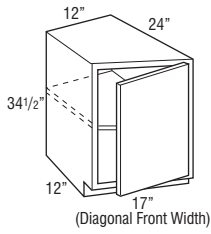

**Hinging Options**  
**Custom Modifications**

AUTH	CBO	CCO	CFNTO	CFP	CFRMO	CMAT	CND	DRT	DRWPWR	DRWSEC	DRWTK	EXBK	EX	FB	FD	FFD	FPEB	FTK	FTK_V	ID	INVFRM	LTI	MIP	P	PTOWB	RD	RECTK	RT	SCPDWR	TD	TOTSSS	TVR_V	VTK	WLI	
•*	•	•	•	•	•	•	•	•	•	•	•	•	•	•	•	•*	•*	•	•	•	•	•	•	•	•	•	•*	•	•	•	•	•	•	•	•

\*Available only on 12" deep side of cabinet \*RECTKALL not available

**Construction Upgrades**

APC	ET	PE
•	•	•

**Door Options**

DPSRR
•

**BTC12LL**

**BTC12RL**

**BTC12LR**

**BTC12RR**

- One adjustable shelf.
- Cabinets constructed with top.
- Specify door hinging, RR shown.
- Depth can be reduced to a minimum of 18".
- RECTKBK, RECTKL and RECTKR cannot be ordered when RD is specified. RECTKL and RECTKR cannot be specified on the same cabinet.
- Full overlay styles use 14 1/2" wide doors with 38NPOHINGE to allow for proper door clearance with adjacent cabinets.

**135° CORNER OUTSIDE BASE**

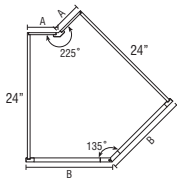
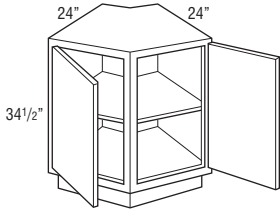

**BFH6COA**

**BFH9COA**

**BFH12COA**

- Doors are hinged on outside of frame.
- Adjustable shelves cannot be removed from the cabinet.

Model	A Dimension	B Dimension
BFH6COA	6"	15 15/16"
BFH9COA	9"	18 15/16"
BFH12COA	12"	21 15/16"

A indicates back width of cabinet and wall space.  
B indicates face frame width.

**Custom Modifications**

AUTH	CBO	CCO	CFNTO	CFP	CFRMO	CMAT	CND	DRT	DRWPWR	DRWSEC	DRWTK	EXBK	EX	FB	FD	FFD	FPEB	FTK	FTK_V	ID	INVFRM	LTI	MIP	P	PTOWB	RD	RECTK	RT	SCPDWR	TD	TOTSSS	TVR_V	VTK	WLI	
•	•	•	•	•	•	•	•	•	•	•	•	•	•	•	•	•	•	•	•	•	•	•	•	•	•	•	•	•	•	•	•	•	•	•	•

**Construction Upgrades**

APC	ET	PE
•	•	•

**Door Options**

DPSRR
•

**135° CORNER INSIDE BASE**

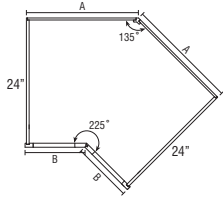
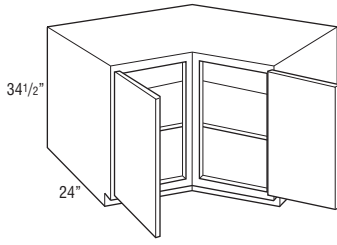

**BFH21CIA**  
**BFH24CIA**  
**BFH27CIA**

- Doors are hinged on outside of frame.
- Adjustable shelves cannot be removed from the cabinet.

Model	A Dimension	B Dimension
BFH21CIA	21"	11 3/32"
BFH24CIA	24"	14 3/32"
BFH27CIA	27"	17 3/32"

A indicates back width of cabinet and wall space.  
B indicates face frame width.

**Custom Modifications**

AUTH	CBO	CCO	CFNTO	CFP	CFRMO	CMAT	CND	DRT	DRWPWR	DRWSEC	DRWTK	EXBK	EX	FB	FD	FFD	FPEB	FTK	FTK_V	ID	INVFRM	LTI	MIP	P	PTOWB	RD	RECTK	RT	SCDRW	TD	TOTSSS	TVR_V	VTK	WLI		
•	•	•																						•*	•										•	•

\*Not available on 21" and 24" wide

**Construction Upgrades**

APC	ET	PE
•		•

**Door Options**

DPSRR
•

**BASE END CABINET**

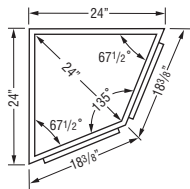
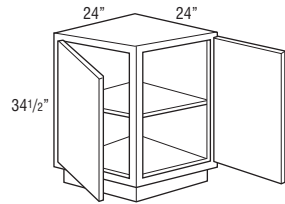

**BEC24**

- Wall width is 24" x 24".
- 24" W x 24" D x 34 1/2" H.
- 24" from outside corner point to frame face.
- Cabinets constructed with top.
- One adjustable shelf.
- Cabinet may be installed against either end of a run.

**Custom Modifications**

AUTH	CBO	CCO	CFNTO	CFP	CFRMO	CMAT	CND	DRT	DRWPWR	DRWSEC	DRWTK	EXBK	EX	FB	FD	FFD	FPEB	FTK	FTK_V	ID	INVFRM	LTI	MIP	P	PTOWB	RD	RECTK	RT	SCDRW	TD	TOTSSS	TVR_V	VTK	WLI		
•	•																																		•	•

**Construction Upgrades**

APC	ET	PE
•		

**Door Options**

DPSRR
•

**TWO DRAWER BASE with FILE DRAWER**

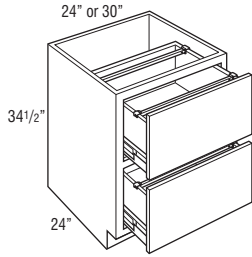

**2DB24FD  
2DB30FD**

- Includes Filing System Hardware Kit, which accommodates letter and legal filing.
- Drawers utilize 125 lb. full extension progressive side-mount guide, does not feature soft-close guide.
- Depth can be reduced to a minimum of 21”.
- Exterior drawer box height is 10”.

**Custom Modifications**

AUTH	CBO	CCO	CFNTO	CFP	CFRMO	CMAT	CND	DRT	DRWPWR	DRWSEC	DRWTK	EXBK	EX	FB	FD	FFD	FPEB	FTK	FTK_V	ID	INVFRM	LTI	MIP	P	PTOWB	RD	RECTK	RT	SCPDRW	TD	TOTSSS	TVR_V	VTK	WLI	
•	•	•			•						•	•	•	•			•	•	•								•	•							•

**Construction Upgrades**

APC	ET	PE
•		•

**Door Options**

DPSRR

**TWO DRAWER BASE**

18”, 21”, 24”, 27”, 30”, 33”, 36”, 42”, or 48”

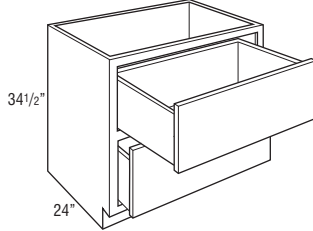

**2DB18  
2DB21  
2DB24  
2DB27  
2DB30  
2DB33  
2DB36  
2DB42  
2DB48**

- Exterior drawer box height is 10”.
- When SCPDRW is selected, the top drawer will utilize a 6 3/8” high drawer box instead of the current 10” high drawer box, creating a clearance of 6 5/8” for the cooktop.
- When 2DB48 is ordered in Door 46 with DFF5PC, drawer fronts will have a vertical cross rail with two center panels.

**Custom Modifications**

AUTH	CBO	CCO	CFNTO	CFP	CFRMO	CMAT	CND	DRT	DRWPWR	DRWSEC	DRWTK	EXBK	EX	FB	FD	FFD	FPEB	FTK	FTK_V	ID	INVFRM	LTI	MIP	P	PTOWB	RD	RECTK	RT	SCPDRW	TD	TOTSSS	TVR_V	VTK	WLI	
•	•	•			•						•*	•	•	•				•	•	•							•*	•	•						•

\*Not available on 42” and 48” wide      \*Depth can be reduced to a minimum of 21” on 42” and 48” wide cabinets

**Construction Upgrades**

APC	ET	PE
•		•

**Door Options**

DPSRR

**TWO DRAWER BASE with PEGGED DISH ORGANIZER**

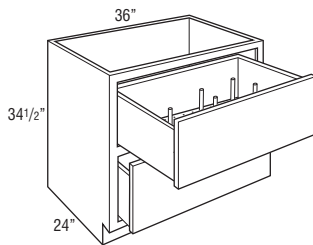

**2DB36PDO**

- Includes 8 wooden posts.
- Includes 19/32” thick removable pegged board in top drawer.
- Exterior drawer box height is 10”.
- Additional posts available as an accessory. See page 373.
- Posts and pegged board available as accessories for field installation. See page 373.
- When SCPDRW is selected, the top drawer will utilize a 6 3/8” high drawer box instead of the current 10” high drawer box, creating a clearance of 6 5/8” for the cooktop.

**Custom Modifications**

AUTH	CBO	CCO	CFNTO	CFP	CFRMO	CMAT	CND	DRT	DRWPWR	DRWSEC	DRWTK	EXBK	EX	FB	FD	FFD	FPEB	FTK	FTK_V	ID	INVFRM	LTI	MIP	P	PTOWB	RD	RECTK	RT	SCPDRW	TD	TOTSSS	TVR_V	VTK	WLI	
•	•	•			•						•	•	•	•				•	•	•							•	•							•

**Construction Upgrades**

APC	ET	PE
•		•

**Door Options**

DPSRR

**TWO DRAWER BASE with ROLL TRAY**

18", 21", 24", 27", 30", 33", or 36"

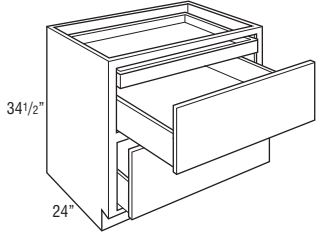

- 2DB18RT
- 2DB21RT
- 2DB24RT
- 2DB27RT
- 2DB30RT
- 2DB33RT
- 2DB36RT

- Includes a roll tray above the top drawer box.
- Exterior height for bottom drawer box is 6 3/8".

**Custom Modifications**

AUTH	CBO	CCO	CFNTO	CFP	CFRMO	CMAT	CND	DRT	DRWPWR	DRWSEC	DRWTK	EXBK	EX	FB	FD	FFD	FPEB	FTK	FTK_V	ID	INVFRM	LTI	MIP	P	PTOWB	RD	RECTK	RT	SCPDRW	TD	TOTSSS	TVR_V	VTK	WLI	
•	•	•			•						•	•	•	•			•	•	•								•	•							•

**Construction Upgrades**

APC	ET	PE
•		•

**Door Options**

DPSRR

**TWO DRAWER BASE with ROLL TRAY and PEGGED DISH ORGANIZER**

36"

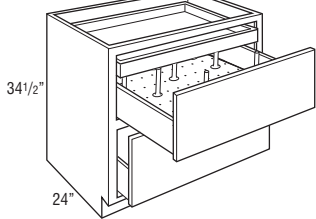

**2DB36RTPDO**

- Includes a roll tray above the top drawer box.
- Includes 8 wooden posts.
- Includes 19/32" thick removable pegged board in top drawer.
- Additional posts available as an accessory. See page 373.
- Posts and pegged board available as accessories for field installation. See page 373.

**Custom Modifications**

AUTH	CBO	CCO	CFNTO	CFP	CFRMO	CMAT	CND	DRT	DRWPWR	DRWSEC	DRWTK	EXBK	EX	FB	FD	FFD	FPEB	FTK	FTK_V	ID	INVFRM	LTI	MIP	P	PTOWB	RD	RECTK	RT	SCPDRW	TD	TOTSSS	TVR_V	VTK	WLI	
•	•	•			•						•	•	•	•			•	•	•								•	•							•

**Construction Upgrades**

APC	ET	PE
•		•

**Door Options**

DPSRR

**TWO DRAWER BASE, DROP-IN RANGE**

30" or 36"

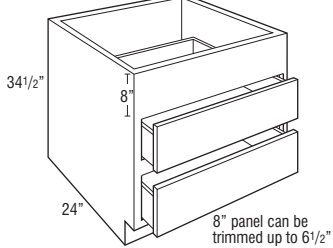

- 2DB30DR
- 2DB36DR

- Exterior height of drawer boxes is 6 3/8".

**Custom Modifications**

AUTH	CBO	CCO	CFNTO	CFP	CFRMO	CMAT	CND	DRT	DRWPWR	DRWSEC	DRWTK	EXBK	EX	FB	FD	FFD	FPEB	FTK	FTK_V	ID	INVFRM	LTI	MIP	P	PTOWB	RD	RECTK	RT	SCPDRW	TD	TOTSSS	TVR_V	VTK	WLI	
•	•	•			•						•	•	•	•			•	•	•								•	•							•

**Construction Upgrades**

APC	ET	PE
•		•

**Door Options**

DPSRR

**THREE DRAWER BASE**

12", 15", 18", or 21"

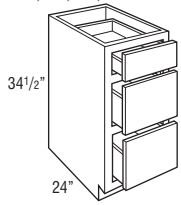

24", 27", 30", 33", or 36"

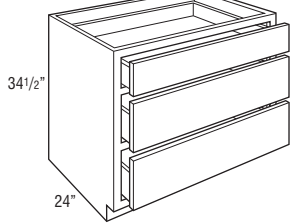

- 3DB12
- 3DB15
- 3DB18
- 3DB21
- 3DB24
- 3DB27
- 3DB30
- 3DB33
- 3DB36

• Exterior height of bottom 2 drawer boxes is 6 3/8".

**Custom Modifications**

AUTH	CBO	CCO	CFNTO	CFP	CFRMO	CMAT	CND	DRT	DRWPWR	DRWSEC	DRWTK	EXBK	EX	FB	FD	FFD	FPEB	FTK	FTK_V	ID	INVFRM	LTI	MIP	P	PTOWB	RD	RECTK	RT	SCPDRW	TD	TOTSSS	TVR_V	VTK	WLI
•	•	•	•	•	•				•*	•+	•*	•	•	•				•	•	•▲						•	•		•					•

\*Not available on 12" and 15" wide    \*Available only on 18", 21", and 24" wide    ▲Not available on 12" wide

**Construction Upgrades**

APC	ET	PE
•		•

**Door Options**

DPSRR

**THREE DRAWER BASE BUFFET**

30", 33", or 36"

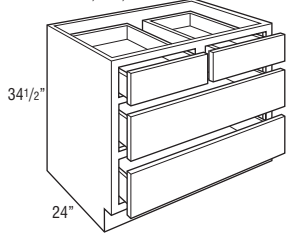

- 3DBB30
- 3DBB33
- 3DBB36

• Exterior height of bottom 2 drawer boxes is 6 3/8".

**Custom Modifications**

AUTH	CBO	CCO	CFNTO	CFP	CFRMO	CMAT	CND	DRT	DRWPWR	DRWSEC	DRWTK	EXBK	EX	FB	FD	FFD	FPEB	FTK	FTK_V	ID	INVFRM	LTI	MIP	P	PTOWB	RD	RECTK	RT	SCPDRW	TD	TOTSSS	TVR_V	VTK	WLI
•	•	•	•	•	•				•*	•*	•	•	•	•				•	•	•						•	•		•					•

\*Not available on 30" and 33" wide

**Construction Upgrades**

APC	ET	PE
•		•

**Door Options**

DPSRR

**THREE DRAWER BASE with WOOD TIERED CUTLERY DIVIDER DRAWER**

15", 18", 21", or 24"

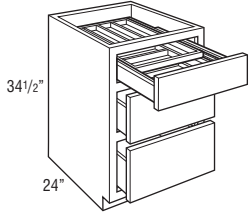

30" or 36"

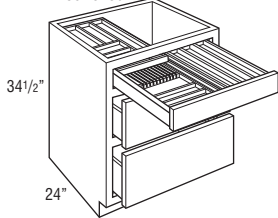

- 3DB15WTC
- 3DB18WTC
- 3DB21WTC
- 3DB24WTC

- 3DB30WTC
- 3DB36WTC

- Exterior height for lower drawer boxes is 6 3/8".
- Exterior WTC drawer box height is 3 3/4", interior height of top and bottom tier is 1 3/8".
- Wood Tiered Cutlery Divider Drawer is also available as an accessory. See page 372.

**Custom Modifications**

AUTH	CBO	CCO	CFNTO	CFP	CFRMO	CMAT	CND	DRT	DRWPWR	DRWSEC	DRWTK	EXBK	EX	FB	FD	FFD	FPEB	FTK	FTK_V	ID	INVFRM	LTI	MIP	P	PTOWB	RD	RECTK	RT	SCPDRW	TD	TOTSSS	TVR	V	VTK	WLI	
•	•	•			•						•*	•	•	•			•	•	•								•								•	

\*Not available on 15" wide

**Construction Upgrades**

APC	ET	PE
•		•

**Door Options**

DPSRR



### THREE DRAWER BASE, WARMING DRAWER

24", 27", 30", or 36"

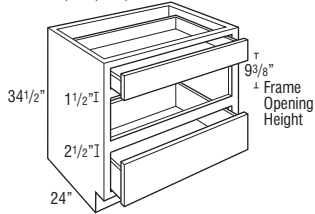

- 3DB24WD
- 3DB27WD
- 3DB30WD
- 3DB36WD

- Exterior height of bottom drawer box is 6 3/8".
- For built-in appliance support, OCINSTALLKIT is included in 24" deep warming drawer cabinets (see page 373 for details), but will not be included when depth is modified.
- OCINSTALLKIT weight limit is 400 lbs. per pair.

Model	Opening Width	Maximum Width	Opening Height	Maximum Height
3DB24WD	21"	22 1/2"	9 3/8"	11 3/8"
3DB27WD	24"	25 1/2"	9 3/8"	11 3/8"
3DB30WD	27"	28 1/2"	9 3/8"	11 3/8"
3DB36WD	33"	34 1/2"	9 3/8"	11 3/8"

#### Custom Modifications

AUTH	CBO	CCO	CFNTO	CFP	CFRMO	CMAT	CND	DRT	DRWPWR	DRWSEC	DRWTK	EXBK	EX	FB	FD	FFD	FPEB	FTK	FTK_V	ID	INVFRM	LTI	MIP	P	PTOWB	RD	RECTK	RT	SCPDRW	TD	TOTSSS	TVR_V	VTK	WLI	
•	•	•	•	•	•	•	•	•	•	•	•	•	•	•	•	•	•	•	•	•	•	•	•	•	•	•	•	•	•	•	•	•	•	•	•

#### Construction Upgrades

APC	ET	PE
•	•	•

#### Door Options

DPSRR

### THREE DRAWER BASE with DEEP DRAWER

24", 27", 30", 33", or 36"

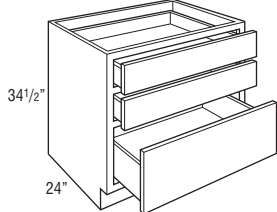

- 3DBDD24
- 3DBDD27
- 3DBDD30
- 3DBDD33
- 3DBDD36

- Exterior height of bottom drawer box is 10".

#### Custom Modifications

AUTH	CBO	CCO	CFNTO	CFP	CFRMO	CMAT	CND	DRT	DRWPWR	DRWSEC	DRWTK	EXBK	EX	FB	FD	FFD	FPEB	FTK	FTK_V	ID	INVFRM	LTI	MIP	P	PTOWB	RD	RECTK	RT	SCPDRW	TD	TOTSSS	TVR_V	VTK	WLI	
•	•	•	•	•	•	•	•	•	•	•	•	•	•	•	•	•	•	•	•	•	•	•	•	•	•	•	•	•	•	•	•	•	•	•	•

#### Construction Upgrades

APC	ET	PE
•	•	•

#### Door Options

DPSRR

### THREE DRAWER BASE BUFFET with DEEP DRAWER

30", 33", or 36"

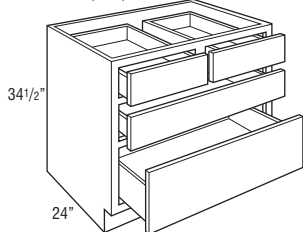

- 3DBBDD30
- 3DBBDD33
- 3DBBDD36

- Exterior height of bottom drawer box is 10".

#### Custom Modifications

AUTH	CBO	CCO	CFNTO	CFP	CFRMO	CMAT	CND	DRT	DRWPWR	DRWSEC	DRWTK	EXBK	EX	FB	FD	FFD	FPEB	FTK	FTK_V	ID	INVFRM	LTI	MIP	P	PTOWB	RD	RECTK	RT	SCPDRW	TD	TOTSSS	TVR_V	VTK	WLI
•	•	•	•	•	•	•	•	•	•*	•*	•	•	•	•	•	•	•	•	•	•	•	•	•	•	•	•	•	•	•	•	•	•	•	•

\*Not available on 30" and 33" wide

#### Construction Upgrades

APC	ET	PE
•	•	•

#### Door Options

DPSRR

**FOUR DRAWER BASE**

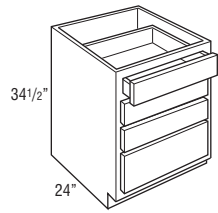

24", 27", 30", 33", or 36"

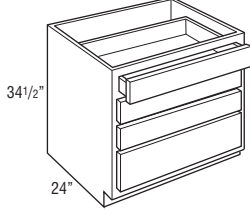

- 4DB12
- 4DB15
- 4DB18
- 4DB21

- 4DB24
- 4DB27
- 4DB30
- 4DB33
- 4DB36

• Exterior height of bottom drawer box is 6 3/8".

**Custom Modifications**

AUTH	CBO	CCO	CFNTO	CFP	CFRMO	CMAT	CND	DRT	DRWPWR	DRWSEC	DRWTK	EXBK	EX	FB	FD	FFD	FPFB	FTK	FTK_V	ID	INVFRM	LTI	MIP	P	PTOWB	RD	RECTK	RT	SCDRW	TD	TOTSSS	TVR	V	VTK	WLI	
•	•	•	•	•	•	•	•	•	•*	•*	•*	•	•	•	•	•	•	•	•	•▲	•	•	•	•	•	•	•	•	•	•	•	•	•	•	•	•

\*Not available on 12" and 15" wide    \*Available only on 18", 21", and 24" wide    ▲Not available on 12" wide

**Construction Upgrades**

APC	ET	PE
•	•	•

**Door Options**

DPSRR

**FOUR DRAWER BASE with WOOD TIERED CUTLERY DIVIDER DRAWER**

15", 18", 21", or 24"

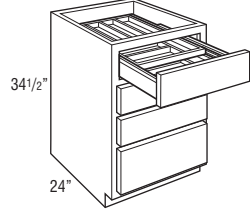

30" or 36"

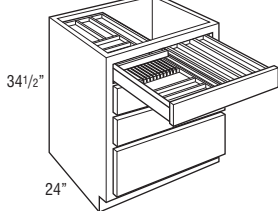

- 4DB15WTC
- 4DB18WTC
- 4DB21WTC
- 4DB24WTC

- 4DB30WTC
- 4DB36WTC

- Exterior WTC drawer box height is 3 3/4", interior height of top and bottom tier is 1 3/8".
- Wood Tiered Cutlery Divider Drawer is also available as an accessory. See page 372.
- Exterior height of bottom drawer box is 6 3/8".

**Custom Modifications**

AUTH	CBO	CCO	CFNTO	CFP	CFRMO	CMAT	CND	DRT	DRWPWR	DRWSEC	DRWTK	EXBK	EX	FB	FD	FFD	FPFB	FTK	FTK_V	ID	INVFRM	LTI	MIP	P	PTOWB	RD	RECTK	RT	SCDRW	TD	TOTSSS	TVR	V	VTK	WLI	
•	•	•	•	•	•	•	•	•	•	•	•*	•	•	•	•	•	•	•	•	•	•	•	•	•	•	•	•	•	•	•	•	•	•	•	•	•

\*Not available on 15" wide

**Construction Upgrades**

APC	ET	PE
•	•	•

**Door Options**

DPSRR

**BASE WASTEBASKET**

**BWB15**

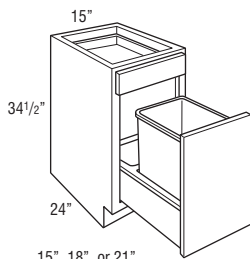

**BWB152**

**BWB18**

**BWB21**

- BWB15 includes one 35 quart gray wastebasket and one trash bag storage area.
- BWB152 includes two 27 quart gray wastebaskets.
- BWB18 and BWB21 include two 35 quart gray wastebaskets.
- BWB15 and BWB18 can be reduced in depth to 21". When reduced, BWB15 includes one wastebasket. When reduced, BWB18 includes one wastebasket and one trash bag storage area.
- Wastebasket lid available for purchase separately, see page 370. BWBLID fits 35 quart wastebaskets.
- BWBLID can only be used on the front wastebasket of BWB18 and BWB21.
- Pull-out features undermount smart close guides.

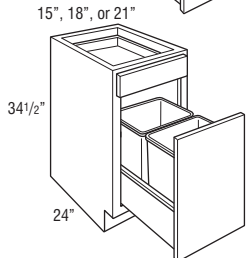

**Custom Modifications**

AUTH	CBO	CCO	CFNTO	CFP	CFRMO	CMAT	CND	DRT	DRWPWR	DRWSEC	DRWTK	EXBK	EX	FB	FD	FFD	FPEB	FTK	FTK_V	ID	INVFRM	LTI	MIP	P	PTOWB	RD	RECTK	RT	SCPDRW	TD	TOTSSS	TVR_V	VTK	WLI	
•	•	•	•	•	•	•	•	•	•*	•*	•*	•	•	•	•	•	•	•	•	•	•	•	•	•	•	•	•	•	•	•	•	•	•	•	•

\*Not available on 15" wide    \*Not available on BWB152 and BWB21

**Construction Upgrades**

APC	ET	PE
•	•	•

**Door Options**

DPSRR
•

**BASE PAPER TOWEL CABINET with WASTEBASKET**

**BPT15WB**

**BPT18WB**

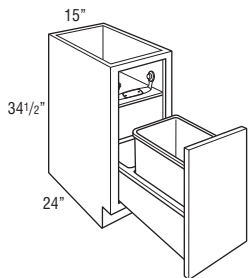

- Upper section of cabinet features an open cubby area with veneer finished interior sides and fixed shelf, a clear and brushed stainless steel paper towel holder, and a storage area behind the paper towel roll for an additional three to four paper towel rolls. Maximum paper towel diameter is 6".
- Cabinet back and lower section of cabinet has standard interior.
- BPT15WB includes one 35 quart gray wastebasket and one trash bag storage area.
- BPT18WB includes two 35 quart gray wastebaskets.
- Can be reduced in depth to 21". When reduced, BPT15WB includes one wastebasket. When reduced, BPT18WB includes one wastebasket and one trash bag storage area.
- BWBLID will not fit due to interference with the cubby area.
- Pull-out features undermount smart close guides.

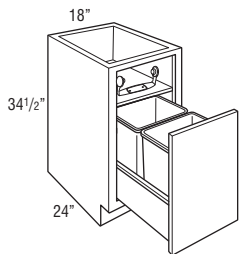

**Custom Modifications**

AUTH	CBO	CCO	CFNTO	CFP	CFRMO	CMAT	CND	DRT	DRWPWR	DRWSEC	DRWTK	EXBK	EX	FB	FD	FFD	FPEB	FTK	FTK_V	ID	INVFRM	LTI	MIP	P	PTOWB	RD	RECTK	RT	SCPDRW	TD	TOTSSS	TVR_V	VTK	WLI	
•	•	•	•	•	•	•	•	•	•	•	•*	•	•	•	•	•	•	•	•	•	•	•	•	•	•	•	•	•	•	•	•	•	•	•	•

\*Not available on 15" wide

**Construction Upgrades**

APC	ET	PE
•	•	•

**Door Options**

DPSRR
•

**BASE WASTEBASKET FULL HEIGHT**

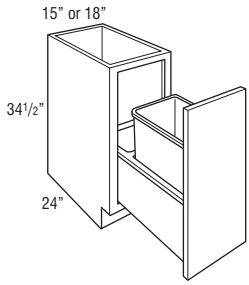

**BWB15FH**  
**BWB18FH**

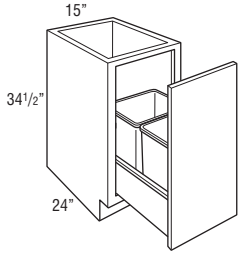

**BWB15FH2**

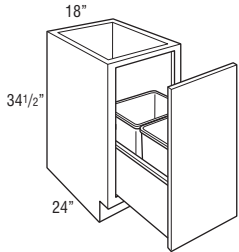

**BWB18FH2**

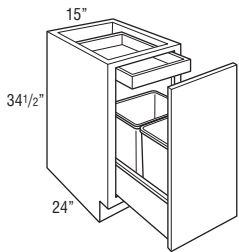

**BWB15FHRT2**

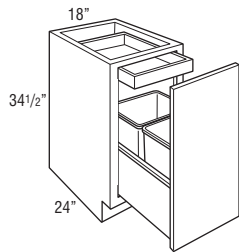

**BWB18FHRT2**

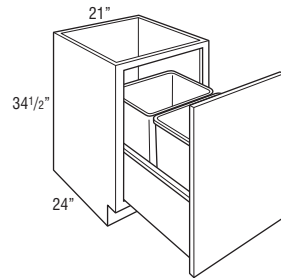

**BWB21FH**

**BWB15FH**  
**BWB18FH**

**BWB15FH2**

**BWB18FH2**

**BWB15FHRT2**

**BWB18FHRT2**

**BWB21FH**

- BWB15FH and BWB18FH include one 50 quart gray wastebasket and one trash bag storage area.
- BWB15FH2 includes two 27 quart gray wastebaskets.
- BWB18FH2 includes two 35 quart gray wastebaskets.
- BWB15FHRT2 includes two 27 quart gray wastebaskets and one roll tray.
- BWB18FHRT2 includes two 35 quart gray wastebaskets and one roll tray.
- BWB21FH has two 50 quart gray wastebaskets.
- Wastebasket lid available for purchase separately, see page 370. BWBLID fits 35 quart wastebaskets. BWBFHLID fits 50 quart wastebaskets.
- BWBLID can only be used on the front wastebasket of BWB18FH2 and BWB18FHRT2.
- BWBFHLID can only be used on the front wastebasket of BWB21FH.
- Pull-out features undermount smart close guides.

**Custom Modifications**

AUTH	CBO	CCO	CFNTO	CFP	CFRMO	CMAT	CND	DRT	DRWPWR	DRWSEC	DRWTK	EXBK	EX	FB	FD	FFD	FPEB	FTK	FTK_V	ID	INVFRM	LTI	MIP	P	PTOWB	RD	RECTK	RT	SCPDWR	TD	TOTSSS	TVR_V	VTK	WLI	
•	•	•			•						•*	•	•	•			•	•	•				•	•	•	•	•	•	•	•	•	•	•	•	•

\*Not available on 15 inch wide

**Construction Upgrades**

APC	ET	PE
•		•

**Door Options**

DPSRR
•

**BASE PAPER TOWEL CABINET with WASTEBASKET, FULL HEIGHT**

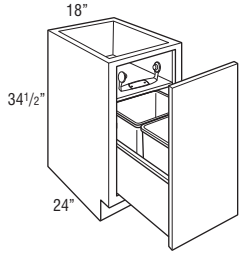
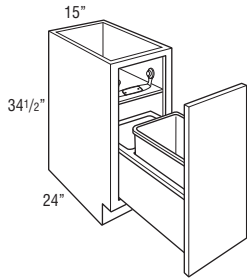

**BPT15WBFH  
BPT18WBFH**

- Upper section of cabinet features a cubby area with veneer finished interior sides and fixed shelf, a clear and brushed stainless steel paper towel holder, and a storage area behind the paper towel roll for an additional three to four paper towel rolls. Maximum paper towel diameter is 6".
- Cabinet back and lower section of cabinet has standard interior.
- BPT15WBFH includes one 35 quart gray wastebasket and one trash bag storage area.
- BPT18WBFH includes two 35 quart gray wastebaskets.
- Can be reduced in depth to 21". When reduced, BPT15WBFH includes one wastebasket. When reduced, BPT18WBFH includes one wastebasket and one trash bag storage area.
- BWBLID will not fit due to interference with the cubby area.
- Pull-out features undermount smart close guides.

**Custom Modifications**

AUTH	CBO	CCO	CFNTO	CFP	CFRMO	CMAT	CND	DRT	DRWPWR	DRWSEC	DRWTK	EXBK	EX	FB	FD	FFD	FPEB	FTK	FTK_V	ID	INVFRM	LTI	MIP	P	PTOWB	RD	RECTK	RT	SCPDRW	TD	TOTSSS	TVR_V	VTK	WLI	
•	•	•									•*	•					•	•	•				•	•	•	•	•							•	•

\*Not available on 15" wide

**Construction Upgrades**

APC	ET	PE
•		•

**Door Options**

DPSRR
•

**BASE BIN TRAY PULL-OUT**

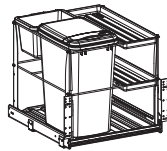
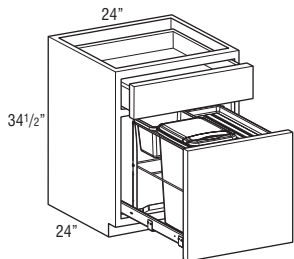

**BBTP24**

- Door mounted pull-out features smart close guides with chrome rails, gray 35 quart wastebasket with lid, gray bin, and two gray plastic trays. All items can be removed for cleaning.
- Bottom of pull-out has a removable gray plastic liner.

**Custom Modifications**

AUTH	CBO	CCO	CFNTO	CFP	CFRMO	CMAT	CND	DRT	DRWPWR	DRWSEC	DRWTK	EXBK	EX	FB	FD	FFD	FPEB	FTK	FTK_V	ID	INVFRM	LTI	MIP	P	PTOWB	RD	RECTK	RT	SCPDRW	TD	TOTSSS	TVR_V	VTK	WLI		
•	•	•																																		

**Construction Upgrades**

APC	ET	PE
•		•

**Door Options**

DPSRR
•

**BASE BIN TRAY PULL-OUT with PET FEEDING DRAWER**

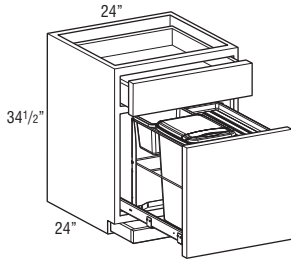

**BBTP24PFD**

- Door mounted pull-out features smart close guides with chrome rails, gray 35 quart wastebasket with lid, gray bin, and two gray plastic trays. All items can be removed for cleaning. See BBTP24 for pull-out drawing.
- Bottom of pull-out has a removable gray plastic liner.
- Pet feeding drawer in the toekick area features push-to-open guides with a removable gray plastic drawer insert.

**Custom Modifications**

AUTH	CBO	CCO	CFNTO	CFP	CFRMO	CMAT	CND	DRT	DRWPWR	DRWSEC	DRWTK	EXBK	EX	FB	FD	FFD	FPEB	FTK	FTK_V	ID	INVFRM	LTI	MIP	P	PTOWB	RD	RECTK	RT	SCPDW	TD	TOTSSS	TVR	V	VTK	WLI		
•	•	•	•	•	•	•	•	•	•	•	•	•	•	•	•	•	•	•	•	•	•	•	•	•	•	•	•	•	•	•	•	•	•	•	•	•	•

**Construction Upgrades**

APC	ET	PE
•	•	•

**Door Options**

DPSRR
•

**BASE BIN TRAY PULL-OUT FULL HEIGHT**

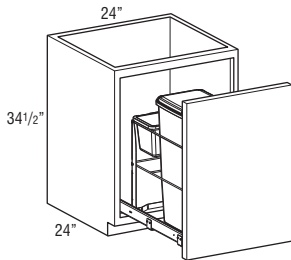

**BBTP24FH**

- Door mounted pull-out features smart close guides with chrome rails, gray 50 quart wastebasket with lid, gray bin, and two gray plastic trays. All items can be removed for cleaning. See BBTP24 for pull-out drawing.
- Bottom of pull-out has a removable gray plastic liner.

**Custom Modifications**

AUTH	CBO	CCO	CFNTO	CFP	CFRMO	CMAT	CND	DRT	DRWPWR	DRWSEC	DRWTK	EXBK	EX	FB	FD	FFD	FPEB	FTK	FTK_V	ID	INVFRM	LTI	MIP	P	PTOWB	RD	RECTK	RT	SCPDW	TD	TOTSSS	TVR	V	VTK	WLI		
•	•	•	•	•	•	•	•	•	•	•	•	•	•	•	•	•	•	•	•	•	•	•	•	•	•	•	•	•	•	•	•	•	•	•	•	•	•

**Construction Upgrades**

APC	ET	PE
•	•	•

**Door Options**

DPSRR
•

**BASE BIN TRAY PULL-OUT FULL HEIGHT with PET FEEDING DRAWER**

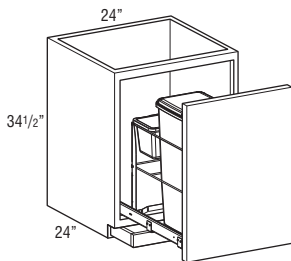

**BBTP24HFPFD**

- Door mounted pull-out features smart close guides with chrome rails, gray 50 quart wastebasket with lid, gray bin, and two gray plastic trays. All items can be removed for cleaning. See BBTP24 for pull-out drawing.
- Bottom of pull-out has a removable gray plastic liner.
- Pet feeding drawer in the toekick area features push-to-open guides with a removable gray plastic drawer insert.

**Custom Modifications**

AUTH	CBO	CCO	CFNTO	CFP	CFRMO	CMAT	CND	DRT	DRWPWR	DRWSEC	DRWTK	EXBK	EX	FB	FD	FFD	FPEB	FTK	FTK_V	ID	INVFRM	LTI	MIP	P	PTOWB	RD	RECTK	RT	SCPDW	TD	TOTSSS	TVR	V	VTK	WLI		
•	•	•	•	•	•	•	•	•	•	•	•	•	•	•	•	•	•	•	•	•	•	•	•	•	•	•	•	•	•	•	•	•	•	•	•	•	•

**Construction Upgrades**

APC	ET	PE
•	•	•

**Door Options**

DPSRR
•

**BASE WINE CUBBY, 24" DEEP**

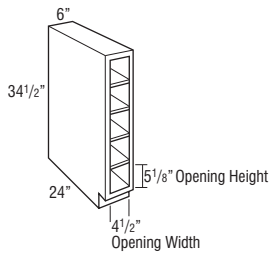

**BWC6**

- Vertical application only.
- Matching interior.
- Frameless drilled and doweled construction.
- Veneer on 3/4" furniture board core.
- Reduced Depth only available in 3" increments down to 12".

**Custom Modifications**

AUTH	CBO	CCO	CFNTO	CFP	CFRMO	CMAT	CND	DRT	DRWPWR	DRWSEC	DRWTK	EXBK	EX	FB	FD	FFD	FPEB	FTK	FTK_V	ID	INVFRM	LTI	MIP	P	PTOWB	RD	RECTK	RT	SCPDRW	TD	TOTSSS	TVR_V	VTK	WLI		
																											•									•

**Construction Upgrades**

APC	ET	PE

**Door Options**

DPSRR

**BASE SPICE DRAWER, 24" DEEP**

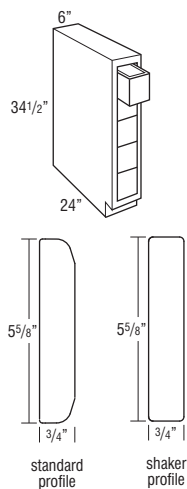

**BSD6**

- See BWC6 (Base Wine Cubby without Drawers).
- Frameless drilled and doweled construction.
- Veneer on a 3/4" furniture board core.
- Vertical application only.
- Matching interior.
- Includes five 1/2" hardwood drawers with rabbet joint, 21 13/16" deep.
- Drawer opening is 4 1/2" wide x 5 1/8" high.
- Features flush end panels which cannot be skinned.
- If ordered with Heirlooming Technique, will not feature sand-through characteristics.
- Reduced Depth only available in 3" increments down to 12".
- Drawer front is unique to item and will not match profile chosen.
- All styles use standard drawer front profile except Door 15, Door 16, Door 18, Door 19, Door 26, Door 28, Door 32, Door 38, Door 41, Door 44, Door 45, Door 46, and Door 47, which use the shaker profile.
- Door 25, Door 33, Door 36, and Door 37 drawer fronts will match doors and drawer fronts.

**Custom Modifications**

AUTH	CBO	CCO	CFNTO	CFP	CFRMO	CMAT	CND	DRT	DRWPWR	DRWSEC	DRWTK	EXBK	EX	FB	FD	FFD	FPEB	FTK	FTK_V	ID	INVFRM	LTI	MIP	P	PTOWB	RD	RECTK	RT	SCPDRW	TD	TOTSSS	TVR_V	VTK	WLI	
																											•								•

**Construction Upgrades**

APC	ET	PE

**Door Options**

DPSRR

**BASE PANTRY PULL-OUT**

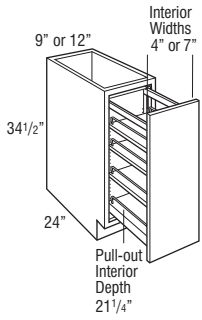

**BPP9**

**BPP12**

- All styles feature a natural finish smart close wood pull-out with adjustable shelves and chrome rail sides. The adjustable rear wall of the pull-out prevents items from falling behind the unit.

**Custom Modifications**

AUTH	CBO	CCO	CFNTO	CFP	CFRMO	CMAT	CND	DRT	DRWPWR	DRWSEC	DRWTK	EXBK	EX	FB	FD	FFD	FPEB	FTK	FTK_V	ID	INVFRM	LTI	MIP	P	PTOWB	RD	RECTK	RT	SCPDWR	TD	TOTSSS	TVR	V	VTK	WLI	
•	•	•			•							•	•				•	•									•*								•	

\*RECTKALL not available on 9" wide

**Construction Upgrades**

APC	ET	PE
•		•

**Door Options**

DPSRR
•

**BASE TRAY DIVIDER PANTRY PULL-OUT**

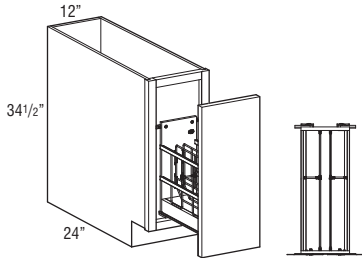

**BTDP12**

- All styles feature a natural finish smart close wood pull-out with two removable center dividers and two snap on T-bars.
- Tray dividers are chrome plated steel.

**Custom Modifications**

AUTH	CBO	CCO	CFNTO	CFP	CFRMO	CMAT	CND	DRT	DRWPWR	DRWSEC	DRWTK	EXBK	EX	FB	FD	FFD	FPEB	FTK	FTK_V	ID	INVFRM	LTI	MIP	P	PTOWB	RD	RECTK	RT	SCPDWR	TD	TOTSSS	TVR	V	VTK	WLI	
•	•	•			•							•	•				•	•									•*								•	•

\*RECTKALL and RECTKL/RECTKR not available

**Construction Upgrades**

APC	ET	PE
•		•

**Door Options**

DPSRR
•



**BASE CONTAINER ORGANIZER PANTRY PULL-OUT**

**BCOPP12**

- Full extension, smart close wood pull-out with natural finish and two fixed shelves.
- Includes seven OXO™ Good Grips POP containers (BPA Free): three 1.7 quart, three 4.3 quart, and one 2.6 quart.

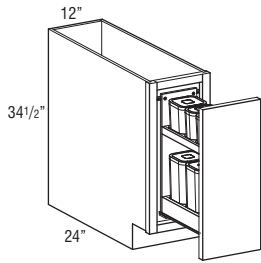

**Custom Modifications**

AUTH	CBO	CCO	CFNTO	CFP	CFRMO	CMAT	CND	DRT	DRWPWR	DRWSEC	DRWTK	EXBK	EX	FB	FD	FFD	FPEB	FTK	FTK_V	ID	INVFRM	LTI	MIP	P	PTOWB	RD	RECTK	RT	SCPDRW	TD	TOTSSS	TVR_V	VTK	WLI	
•	•	•			•							•	•	•				•	•					•			•							•	•

**Construction Upgrades**

APC	ET	PE
•		•

**Door Options**

DPSRR
•

**BASE UTENSIL PANTRY PULL-OUT**

**BUPP9**

**BUPP12**

- All styles feature a natural finish smart close wood pull-out with two adjustable shelves (including canister shelf) and one fixed shelf with chrome rail sides. Top adjustable shelf features three stainless steel canisters for utensils. The adjustable rear wall of the pull-out prevents items from falling behind the unit.
- BUPP9 canisters are 5.85" tall and have an inside diameter of 4.3".
- BUPP12 canisters are 6.7" tall and have an inside diameter of 5".

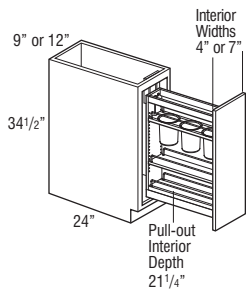

**Custom Modifications**

AUTH	CBO	CCO	CFNTO	CFP	CFRMO	CMAT	CND	DRT	DRWPWR	DRWSEC	DRWTK	EXBK	EX	FB	FD	FFD	FPEB	FTK	FTK_V	ID	INVFRM	LTI	MIP	P	PTOWB	RD	RECTK	RT	SCPDRW	TD	TOTSSS	TVR_V	VTK	WLI
•	•	•			•							•	•	•				•	•								•*							•

\*RECTKALL not available on 9" wide

**Construction Upgrades**

APC	ET	PE
•		•

**Door Options**

DPSRR
•

**BASE UTENSIL PANTRY PULL-OUT with KNIFE BLOCK**

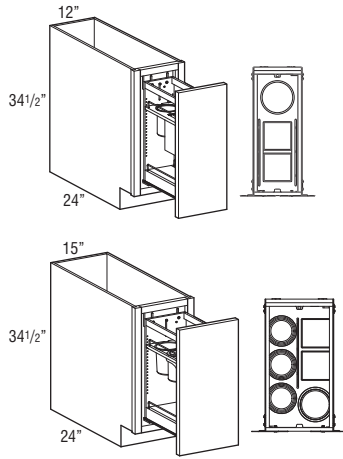

**BUPPKB12**

**BUPPKB15**

- Full extension, smart close wood pull-out with natural finish and one fixed shelf.
- BUPPKB12 features an adjustable shelf with two knife blocks, one stainless steel canister, four cutting boards, and one fixed shelf with chrome rails. Canister is 6.7" tall and has an inside diameter of 5".
- BUPPKB15 features an adjustable shelf with two knife blocks, four stainless steel canisters, four cutting boards, and one fixed shelf with chrome rails. Three canisters are 5.85" tall and have an inside diameter of 4.3", and one is 6.7" tall with an inside diameter of 5".
- Knife block features movable flex rods that adjust to hold a multitude of knives.
- Includes adjustable rear wall for extra strength and stability.
- Adjustable shelf is easily reversible for placement of knife blocks in the front or rear.

**Custom Modifications**

AUTH	CBO	CCO	CFNT0	CFP	CFRMO	CMAT	CND	DRT	DRWPWR	DRWSEC	DRWTK	EXBK	EX	FB	FD	FFD	FPEB	FTK	FTK V	ID	INVFRM	LTI	MIP	P	PTOWB	RD	RECTK	RT	SCPDWR	TD	TOTSSS	TVR	V	VTK	WLI	
•	•	•			•							•	•	•			•	•	•*								•								•	

\*Not available on 12" wide

**Construction Upgrades**

APC	ET	PE
•		•

**Door Options**

DPSRR
•

**BASE BOX COLUMN PULL-OUT**

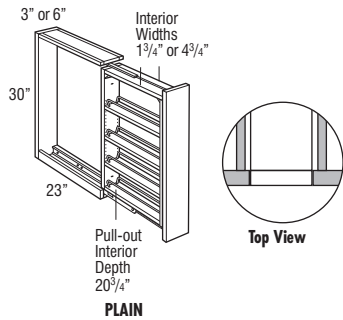

**PLAIN**

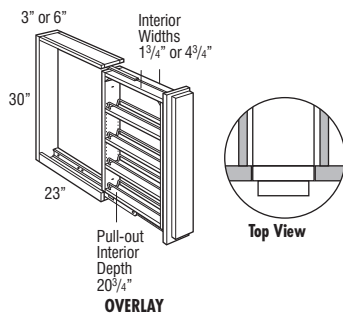

**OVERLAY**

**BBCPO3 (Plain)**

**BBCPO6 (Plain)**

**BBCPO30L (Overlay)**

**BBCPO60L (Overlay)**

- Recommend installation between two cabinets. Can be installed on the end of a run or adjacent to an appliance with a 3/4" thick end panel.
- Filler is included but unattached.
- Install unit before removing shipping brace and attaching filler.
- Overlay application includes profiled full overlay filler.
- Decorative hardware required on base units.
- Modifications not available.
- Toekick not included; must be built up in the field.
- If installed next to an appliance an End Panel must be installed onto the pull-out adjacent to the appliance.
- All styles feature a natural finish smart close wood pull-out with adjustable shelves and chrome rail sides.
- BBCPO3 and BBCPO6 will not feature sand-through characteristics if ordered with Heirlooming Technique.
- In order to allow proper clearance for opening and closing, allow an additional 1/8" space between adjacent cabinet face frames. The 3" wide pull-outs require 3 1/8" space and the 6" wide pull-outs require 6 1/8" space. Spacers are included with the pull-outs to allow for proper installation.
- For full access from both sides of unit, do not install against a wall or next to deeper appliances and cabinets.

**MODIFICATIONS**

No modifications available for these products.

**Finish Techniques**

Distressing	Heirlooming
•	•*

\*Not available on Plain

### BASE MESSAGE CENTER

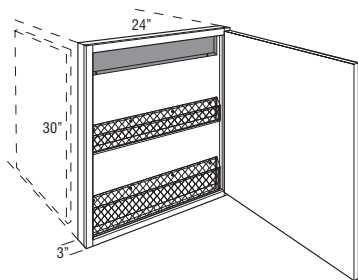

#### BMC24 L or R

- Includes magazine holder, bulletin board, and mail holder.
- Not recommended for use next to a Peninsula cabinet due to the additional 1/4" cabinet depth.
- Door will open 90° without decorative hardware.
- Cabinet should be hinged on wall side.
- For proper installation, adjacent cabinet must have FPFB or 1/4" skin applied.
- Overlay fillers can be used on side of cabinet to add a decorative touch.

#### Custom Modifications

AUTH	CBO	CCO	CFNTO	CFP	CFRMO	CMAT	CND	DRT	DRWPWR	DRWSEC	DRWTK	EXBK	EX	FB	FD	FFD	FPFB	FTK	FTK_V	ID	INVFRM	LTI	MIP	P	PTOWB	RD	RECTK	RT	SCPDRW	TD	TOTSSS	TVR_V	VTK	WLI		

#### Construction Upgrades

APC	ET	PE
•		

#### Door Options

DPSRR
•

### BASE DROP-IN RANGE CABINET

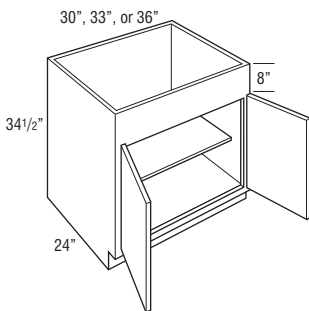

#### B30DR-B36DR

39", 42", 45", or 48"

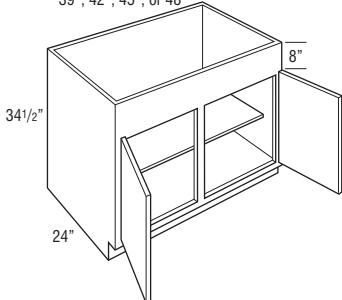

#### B39DR-B48CSDR

#### B30DR

#### B33DR

#### B36DR

#### B39DR

#### B42DR

#### B45DR

#### B48CSDR

#### B48DR

- 8" panel can be trimmed up to 6 1/2".
- Adjustable 15" deep shelf.
- Can also be used with apron front sinks, refer to manufacturer's dimension requirements.

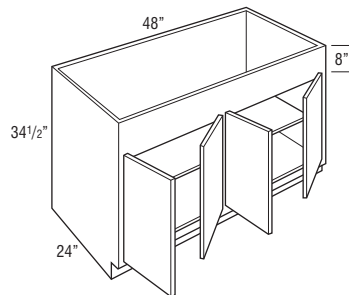

#### B48DR

#### Custom Modifications

AUTH	CBO	CCO	CFNTO	CFP	CFRMO	CMAT	CND	DRT	DRWPWR	DRWSEC	DRWTK	EXBK	EX	FB	FD	FFD	FPFB	FTK	FTK_V	ID	INVFRM	LTI	MIP	P	PTOWB	RD	RECTK	RT	SCPDRW	TD	TOTSSS	TVR_V	VTK	WLI	
											*																								

\*Available only on 30", 33", and 36" wide

#### Construction Upgrades

APC	ET	PE
•		

#### Door Options

DPSRR
•

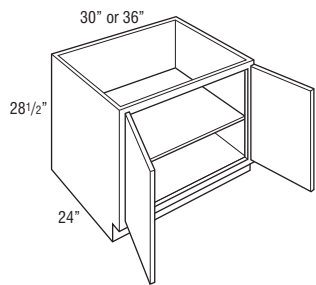
**FULL HEIGHT RANGETOP BASE****RTBFH3028.5****RTBFH3628.5****RTBFH4828.5CS**

- One full depth shelf.
- Aligns with standard base cabinet door. Door height is 23".
- Top cross rail is 2" high, can be trimmed up to 1".
- Installed Roll Trays may interfere with gas line, see chart on page 46 for clearance depth behind roll tray.
- For use with rangetops with front controls.

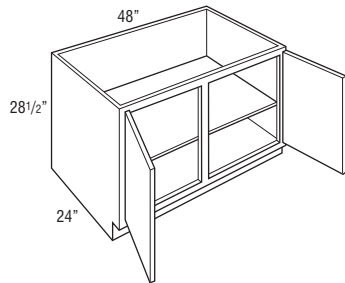
**214****BASE CABINETS****Custom Modifications**

AUTH	CBO	CCO	CFNTO	CFP	CFRMO	CMAT	CND	DRT	DRWPWR	DRWSEC	DRWTK	EXBK	EX	FB	FD	FFD	FPEB	FTK	FTK_V	ID	INVFRM	LTI	MIP	P	PTOWB	RD	RECTK	RT	SCPDRW	TD	TOTSSS	TVR_V	VTK	WLI	
•	•	•	•	•	•	•	•	•	•	•	•	•	•	•	•	•	•	•	•	•	•	•	•	•	•	•	•	•	•	•	•	•	•	•	•

**Construction Upgrades**

APC	ET	PE
•	•	•

**Door Options**

DPSRR
•

### BASE OVEN CABINET

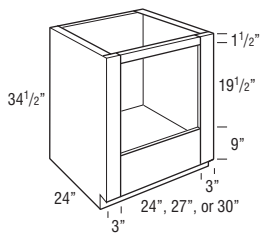

#### BO30

#### BO33

#### BO36

- Oven cabinet has laminated interior.
- May not hold cooktop and slide-in oven combination. Refer to cooktop and slide-in oven manufacturer specifications.
- If ordered with Heirlooming Technique, will not feature sand-through characteristics.
- For built-in appliance support, OCINSTALLKIT is included in 24" deep oven cabinets (see page 373 for details), but will not be included when depth is modified.
- OCINSTALLKIT weight limit is 400 lbs. per pair.

Model	Opening Width	Maximum Width	Opening Height	Maximum Height*
BO30	24"	28 1/2"	19 1/2"	27 1/2"
BO33	27"	31 1/2"	19 1/2"	27 1/2"
BO36	30"	34 1/2"	19 1/2"	27 1/2"

\*Top frame cross rail can be removed during field installation if cabinet is properly installed between two adjacent cabinets, increasing the maximum height to 28 1/4".

#### Custom Modifications

AUTH	CBO	CCO	CFNTO	CFP	CFRMO	CMAT	CND	DRT	DRWPWR	DRWSEC	DRWTK	EXBK	EX	FB	FD	FFD	FPEB	FTK	FTK_V	ID	INVFRM	LTI	MIP	P	PTOWB	RD	RECTK	RT	SCPDWR	TD	TOTSSS	TVR_V	VTK	WLI		
•																																				

#### Construction Upgrades

APC	ET	PE
•		

#### Door Options

DPSRR

### BASE BUILT-IN MICROWAVE CABINET with DRAWER

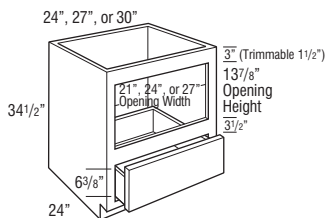

#### BBMWD24

#### BBMWD27

#### BBMWD30

- Standard interior.
- For built-in appliance support, OCINSTALLKIT is included in 24" deep cabinets (see page 373 for details), but will not be included when depth is modified.
- OCINSTALLKIT weight limit is 400 lbs. per pair.
- The usable cabinet face height between top of drawer front and top of cabinet is 19 3/4". Be sure to verify overall appliance height, gap requirements, and cut-out dimensions with cabinet specifications.

Model	Opening Width	Maximum Width	Opening Height	Maximum Height
BBMWD24	21"	22 1/2"	13 7/8"	16 7/8"
BBMWD27	24"	25 1/2"	13 7/8"	16 7/8"
BBMWD30	27"	28 1/2"	13 7/8"	16 7/8"

#### Custom Modifications

AUTH	CBO	CCO	CFNTO	CFP	CFRMO	CMAT	CND	DRT	DRWPWR	DRWSEC	DRWTK	EXBK	EX	FB	FD	FFD	FPEB	FTK	FTK_V	ID	INVFRM	LTI	MIP	P	PTOWB	RD	RECTK	RT	SCPDWR	TD	TOTSSS	TVR_V	VTK	WLI	
•																																			

#### Construction Upgrades

APC	ET	PE
•		

#### Door Options

DPSRR

### BASE MICROWAVE CABINET with DRAWER

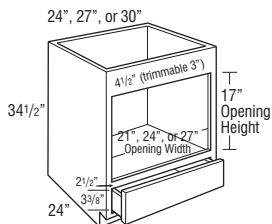

#### BMWD24

#### BMWD27

#### BMWD30

- Matching Interior Plywood (MIP) standard.
- Reinforced plywood floor.
- The usable cabinet face height between top of drawer front and top of cabinet is 23 1/2". Be sure to verify overall appliance height, gap requirements, and cut-out dimensions with cabinet specifications.

Model	Opening Width	Maximum Width	Opening Height	Maximum Height
BMWD24	21"	22 1/2"	17"	20"
BMWD27	24"	25 1/2"	17"	20"
BMWD30	27"	28 1/2"	17"	20"

#### Custom Modifications

AUTH	CBO	CCO	CFNTO	CFP	CFRMO	CMAT	CND	DRT	DRWPWR	DRWSEC	DRWTK	EXBK	EX	FB	FD	FFD	FPEB	FTK	FTK_V	ID	INVFRM	LTI	MIP	P	PTOWB	RD	RECTK	RT	SCPDWR	TD	TOTSSS	TVR_V	VTK	WLI	
•																																			

#### Construction Upgrades

APC	ET	PE
•		

#### Door Options

DPSRR

**BASE MICROWAVE CABINET with DEEP DRAWER**

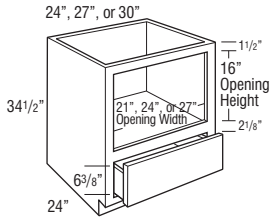

- BMWD24DD**
- BMWD27DD**
- BMWD30DD**

- Matching Interior Plywood (MIP) standard.
- Reinforced plywood floor.
- The usable cabinet face height between top of drawer front and top of cabinet is 18 3/8". Be sure to verify overall appliance height, gap requirements, and cut-out dimensions with cabinet specifications.

Model	Opening Width	Maximum Width	Opening Height	Maximum Height
BMWD24DD	21"	22 1/2"	16"	16"
BMWD27DD	24"	25 1/2"	16"	16"
BMWD30DD	27"	28 1/2"	16"	16"

**Custom Modifications**

AUTH	CBO	CCO	CFNTO	CFP	CFRMO	CMAT	CND	DRT	DRWPWR	DRWSEC	DRWTK	EXBK	EX	FB	FD	FFD	FPEB	FTK	FTK_V	ID	INVFRM	LTI	MIP	P	PTOWB	RD	RECTK	RT	SCPDWR	TD	TOTSSS	TVR_V	VTK	WLI		
•	•	•	•	•	•	•	•	•	•	•	•	•	•	•	•	•	•	•	•	•	•	•	•	•	•	•	•	•	•	•	•	•	•	•	•	•

**Construction Upgrades**

APC	ET	PE

**Door Options**

DPSRR

**BASE MICROWAVE CABINET, SINGLE or DOUBLE DOOR, 46 1/2" HIGH**

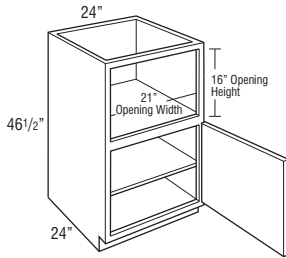

**BMW2448 L or R**

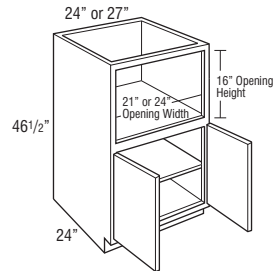

**BMW2448-BMW2748**

**BMW2448 L or R**

- BMW2448**
- BMW2748**

**BMW3048**

- Matching Interior Plywood (MIP) standard.
- Reinforced plywood floor.

Model	Opening Width	Maximum Width	Opening Height	Maximum Height
BMW2448 L or R	21"	22 1/2"	16"	16"
BMW2448	21"	22 1/2"	16"	16"
BMW2748	24"	25 1/2"	16"	16"
BMW3048	27"	28 1/2"	18 1/2"	21 1/2"

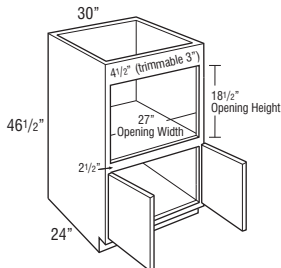

**BMW3048**

**Custom Modifications**

AUTH	CBO	CCO	CFNTO	CFP	CFRMO	CMAT	CND	DRT	DRWPWR	DRWSEC	DRWTK	EXBK	EX	FB	FD	FFD	FPEB	FTK	FTK_V	ID	INVFRM	LTI	MIP	P	PTOWB	RD	RECTK	RT	SCPDWR	TD	TOTSSS	TVR_V	VTK	WLI		
•	•	•	•	•	•	•	•	•	•	•	•	•	•	•	•	•	•	•	•	•	•	•	•	•	•	•	•	•	•	•	•	•	•	•	•	•

**Construction Upgrades**

APC	ET	PE

**Door Options**

DPSRR
•

**BASE CORNER PENINSULA**

**BCP24 L or R**

**BCP24**

- Cabinet width is 24".
- Adjustable full depth shelf.
- Includes two 3" fillers, shipped unattached. Fillers are required for drawer and door opening clearance of adjacent cabinets.
- Unfinished toekick on front (B24) and back (BCP) of cabinet.
- Will not accept roll trays.
- Peninsula base cabinets are 1/4" deeper to allow back paneling application on adjacent cabinets in a run with standard 24" deep cabinets.

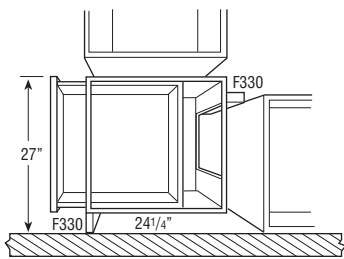

**Custom Modifications**

AUTH	CBO	CCO	CFNTO	CFP	CFRMO	CMAT	CND	DRT	DRWPWR	DRWSEC	DRWTK	EXBK	EX	FB	FFD	FPEB	FTK	FTK_V	ID	INVFRM	LTI	MIP	P	PTOWB	RD	RECTK	RT	SCPDRW	TD	TOTSSS	TVR_V	VTK	WLI		
•	•	•	•	•	•	•	•	•	•	•	•	•	•	•	•	•	•	•	•	•	•	•	•	•	•	•	•	•	•	•	•	•	•	•	•

\*RECTKALL not available, RECTKBK is standard, and RECTKL/RECTKR are available

**Construction Upgrades**

APC	ET	PE
•	•	•

**Door Options**

DPSRR
•

**BASE CORNER PENINSULA with FULL HEIGHT DOOR**

**BCP24FH L or R**

**BCP24FH**

- Cabinet width is 24".
- Adjustable full depth shelf.
- Includes two 3" fillers, shipped unattached. Fillers are required for drawer and door opening clearance of adjacent cabinets.
- Unfinished toekick on front (B24) and back (BCP) of cabinet.
- Will not accept roll trays.
- Peninsula base cabinets are 1/4" deeper to allow back paneling application on adjacent cabinets in a run with standard 24" deep cabinets.

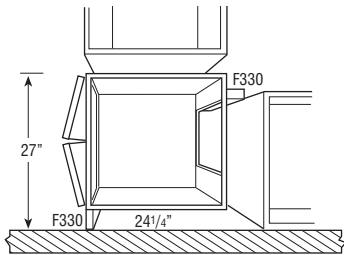
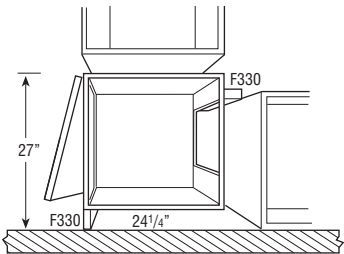

**Custom Modifications**

AUTH	CBO	CCO	CFNTO	CFP	CFRMO	CMAT	CND	DRT	DRWPWR	DRWSEC	DRWTK	EXBK	EX	FB	FFD	FPEB	FTK	FTK_V	ID	INVFRM	LTI	MIP	P	PTOWB	RD	RECTK	RT	SCPDRW	TD	TOTSSS	TVR_V	VTK	WLI		
•	•	•	•	•	•	•	•	•	•	•	•	•	•	•	•	•	•	•	•	•	•	•	•	•	•	•	•	•	•	•	•	•	•	•	•

\*RECTKALL not available, RECTKBK is standard, and RECTKL/RECTKR are available

**Construction Upgrades**

APC	ET	PE
•	•	•

**Door Options**

DPSRR
•

**BASE QUARTER ROUND END SHELF**

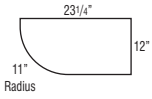
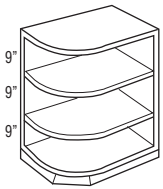

**BQRES**

- Reversible.
- 12" wide x 23 1/4" deep x 11" radius.
- Separate pedestal base included.
- Angled pedestal design allows easier application of matching toeboard.
- Veneer construction finished to match cabinet face frame.
- Veneer on a 3/4" furniture board core.
- Matching interior.
- Cabinet is to be installed behind the face frame of the adjacent 24" deep base cabinet, features two unfinished back panels.
- If ordered with Heirlooming Technique, will not feature sand-through characteristics.

MODIFICATIONS
No modifications available for these products.

**Construction Upgrades**

APC	ET	PE
•		

**BASE OPEN CABINET with PLAIN BACK**

15", 18", 24", 30", or 36"

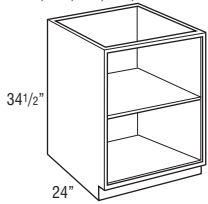

**BOCP15**

**BOCP18**

**BOCP24**

**BOCP30**

**BOCP36**

- Matching Interior Plywood (MIP) standard.
- If ordered with Heirlooming Technique, will not feature sand-through characteristics.
- To change the top rail valance, specify one of the following modifications: Arch (TVRAV), Furniture (TVRFV), or Straight Valance (TVRVV).

**Custom Modifications**

AUTH	CBO	CCO	CFNTO	CFP	CFRMO	CMAT	CND	DRT	DRWPWR	DRWSEC	DRWTK	EXBK	EX	FB	FD	FFD	FPEB	FTK	FTK_V	ID	INVFRM	LTI	MIP	P	PTOWB	RD	RECTK	RT	SCPDRW	TD	TOTSSS	TVR_V	VTK	WLI
•	STD				•						•*	•	•			STD		•	•	•	•		STD	•		•	•					•	•	

\*Not available on 15" wide

**Construction Upgrades**

APC	ET	PE

**Door Options**

DPSRR



All Universal Access Cabinets are 32 1/2" high unless otherwise noted.

- Available
- STD Standard on these cabinets



5 Day Express Response Item

**B2432.5**

Cabinet Type ← → Cabinet Width

**CUSTOM MODIFICATIONS**

Mod.	Description	Mod.	Description
ACS	Appliance Cut-out, Single	EXL	Extended Stile - Left
CBO	Cabinet Box Only	EXR	Extended Stile - Right
CCO	Cabinet Case Only	FB	Finished Ends
CFNT0	Cabinet Front Only	FD	Full Depth Shelf
CFP	Cabinet False Panel	FPEB	Furniture Finished Plywood Ends
CFRMO	Cabinet Frame Only	ID	Increased Depth
CMAT	CabMat™	INVFRM	Inverted Frame
CND	Cabinet with No Door, with Drawer	LTI	Light Installed Battery Strip
DRT	Deep Roll Tray	MIP	Matching Interior Plywood
DRWPWR	PowerGlide™ Compact Drawer Outlet	RD	Reduced Depth
DRWSEC	Biometric Secured Drawer	RT	Installed Roll Tray
EXBKL	End Extended Back - Left	SCPDRW	Scooped Drawer
EXBKR	End Extended Back - Right	TOTSSS	Tilt-out Tray, Stainless Steel Slim
		VTK	Void Toekick
		WLI	White Laminate Interior

**CONSTRUCTION UPGRADES**

Mod.	Description
APC	All-plywood Construction
PE	Plywood Ends

**DOOR OPTIONS**

Mod.	Description
DPSRR	Door Panel - Solid Reverse Raised
MFO	Modified Full Overlay

**UNIVERSAL ACCESS BASE, SINGLE DOOR**

12", 15", 18", or 21"

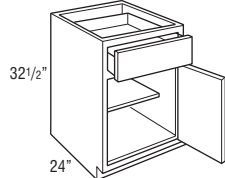

**B1232.5 L or R**

**B1532.5 L or R**

**B1832.5 L or R**

**B2132.5 L or R**

- Adjustable 15" deep shelf.

**Custom Modifications**

ACS	CBO	CCO	CFNT0	CFP	CFRMO	CMAT	CND	DRT	DRWPWR	DRWSEC	EXBK	EX	FB	FD	FPEB	ID	INVFRM	LTI	MIP	RD	RT	SCPDRW	TOTSSS	VTK	WLI
	•	•	•	•	•		•		•*	•*	•	•	•	•	•		•	•*	•	•	•	•		•	•

\*Not available on 12" and 15" wide    \*Not available on 12" wide

**Construction Upgrades**

APC	PE
•	•

**Door Options**

DPSRR	MFO
•	

**UNIVERSAL ACCESS BASE, DOUBLE DOOR**

24", 30", or 36"

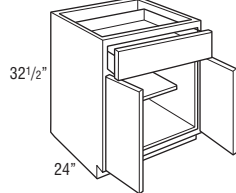

**B2432.5**

**B3032.5**

**B3632.5**

- Adjustable 15" deep shelf.

**Custom Modifications**

ACS	CBO	CCO	CFNT0	CFP	CFRMO	CMAT	CND	DRT	DRWPWR	DRWSEC	EXBK	EX	FB	FD	FPEB	ID	INVFRM	LTI	MIP	RD	RT	SCPDRW	TOTSSS	VTK	WLI
	•	•	•	•	•		•		•	•*	•	•	•	•	•		•	•	•	•	•	•		•	•

\*Available only on 24" wide

**Construction Upgrades**

APC	PE
•	•

**Door Options**

DPSRR	MFO
•	

**UNIVERSAL ACCESS SINK BASE**

30" or 36"

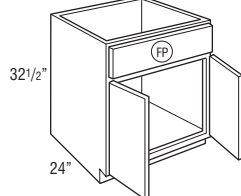

FP = False Panel

**SB3032.5**

**SB3632.5**

- Mini Touch-up Kit (MTUK) included. MTUK includes small touch-up marker and small fill stick.

**Custom Modifications**

ACS	CBO	CCO	CFNT0	CFP	CFRMO	CMAT	CND	DRT	DRWPWR	DRWSEC	EXBK	EX	FB	FD	FPEB	ID	INVFRM	LTI	MIP	RD	RT	SCPDRW	TOTSSS	VTK	WLI
				STD	•	•	•				•	•	•	•	•		•	•	•	•	•		•	•	•

**Construction Upgrades**

APC	PE
•	•

**Door Options**

DPSRR	MFO
•	

**UNIVERSAL ACCESS SINK BASE with TILT-OUT TRAYS**

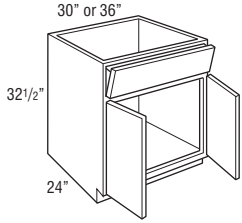

**SB3032.5ST**  
**SB3632.5ST**

- Tilt-out trays are stain resistant, moisture resistant plastic to allow storage of sponges and other cleaning materials.
- Mini Touch-up Kit (MTUK) included. MTUK includes small touch-up marker and small fill stick.
- Includes two tilt-out trays.
- Tilt-out trays are also available as an accessory for field installation. See page 375.

**Custom Modifications**

ACS	CBO	CCO	CFNT0	CFP	CFRMO	CMAT	CND	DRT	DRWPWR	DRWSEC	EXBK	EX	FB	FD	FPEB	ID	INVFRM	LTI	MIP	RD	RT	SCPRW	TOTSSS	VTK	WLI	
		•	•		•	•					•	•	•		•			•	•	•					•	•

**Construction Upgrades**

APC	PE
•	•

**Door Options**

DPSRR	MFO
•	

**UNIVERSAL ACCESS SUPER LAZY SUSAN**

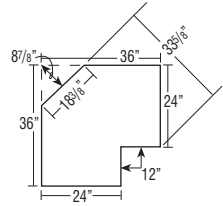
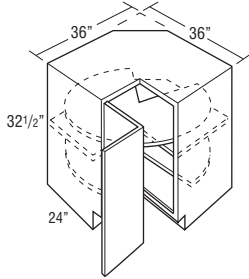

Due to fixed shelf mounting, susans cannot be retrofitted.

**SLS3632.5 L or R**

- SLS3632.5 L or R wall width is 36" x 36".
- Features two plywood susans with a 1" plywood lip. Lower susan is mounted to floor. Upper susan is mounted to fixed shelf. Fixed shelf is 1/2" thick laminated furniture board.
- Decorative hardware screws must be countersunk to prevent scratching adjacent cabinets and face frame of SLS.
- Integrated soft-close hinge not included.

**Custom Modifications**

ACS	CBO	CCO	CFNT0	CFP	CFRMO	CMAT	CND	DRT	DRWPWR	DRWSEC	EXBK	EX	FB	FD	FPEB	ID	INVFRM	LTI	MIP	RD	RT	SCPRW	TOTSSS	VTK	WLI	
		•											•		•			•	•						•	•

**Construction Upgrades**

APC	PE
•	•

**Door Options**

DPSRR	MFO
•	

**UNIVERSAL ACCESS THREE DRAWER BASE**

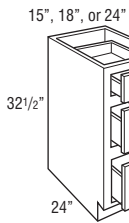

**3DB1532.5**  
**3DB1832.5**  
**3DB2432.5**

- 1 shallow and 2 deep drawers.

**Custom Modifications**

ACS	CBO	CCO	CFNT0	CFP	CFRMO	CMAT	CND	DRT	DRWPWR	DRWSEC	EXBK	EX	FB	FD	FPEB	ID	INVFRM	LTI	MIP	RD	RT	SCPRW	TOTSSS	VTK	WLI	
		•	•		•	•				•*	•*	•	•	•	•					•			•		•	•

\*Not available on 15" wide

**Construction Upgrades**

APC	PE
•	•

**Door Options**

DPSRR	MFO

**UNIVERSAL ACCESS BASE MICROWAVE with DEEP DRAWER**

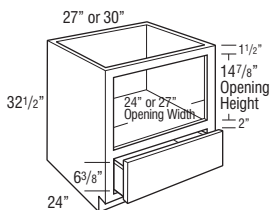

**BMWD2732.5DD**  
**BMWD3032.5DD**

- 1 deep drawer below microwave.
- Matching Interior Plywood (MIP) standard.

**Custom Modifications**

ACS	CBO	CCO	CFNT0	CFP	CFRMO	CMAT	CND	DRT	DRWPWR	DRWSEC	EXBK	EX	FB	FD	FPEB	ID	INVFRM	LTI	MIP	RD	RT	SCPRW	TOTSSS	VTK	WLI	
		•	•		•						•	•		•					STD	•					•	•

**Construction Upgrades**

APC	PE

**Door Options**

DPSRR	MFO

## UNIVERSAL ACCESS DESK LEG

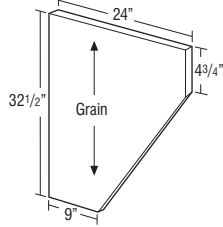

## VDL32.5WD

- VDL32.5WD in Stains: 3/4" thick veneered furniture board.
- VDL32.5WD in Paints: 3/4" thick veneered or solid furniture board.
- All panels are finished two sides and front edge.

### MODIFICATIONS

No modifications available for these products.

### Finish Techniques

Distressing	Heirlooming
-------------	-------------

### Species Availability (Wood)

	Rustic Alder	Cherry	Rustic Hickory	Maple	Oak
•	Alder	•	Hickory	•	•

### Species Availability (All Laminates)

High Glass	Horiz. Grain on Maple	Vert. Grain on Maple	Vert. Grain on Cherry	Vert. Grain on Oak
box color	box color	box color	box color	box color

## VANITY WALL SINK

27", 30", 33", or 39"

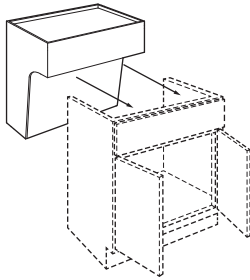
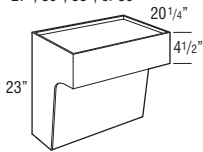

## VWS2723

## VWS3023

## VWS3323

## VWS3923

- Matching Interior Plywood (MIP) standard.
- Recommended installation height of 32" high with 9" of clearance below.
- Front panel is attached with clips for easy removal for access to plumbing.
- Finished veneer plywood exterior and interior.
- For proper installation, cabinet must be secured on each side through both the top and bottom of the back panel into wall studs. Installation instructions and required 3 1/2" installation screws included, standard 2 1/2" installation screws are not sufficient in this application.
- Features a full cabinet top that can be routed for sink installation.
- Approximate weight limit is 400 lbs. per cabinet (includes weight of the cabinet, countertop and contents). Proper installation is required and additional bracing may be required.
- Includes connector clips to mount the sink base to the Removable Vanity Sink Base (RVWS..32). RVWS..32 not included, see below.

### Custom Modifications

ACS	CBD	CCO	CFNTO	CFP	CFRMO	CMAT	CND	DRT	DRWPWR	DRWSEC	EXBK	EX	FB	FD	FPFB	ID	INVFRM	LTI	MIP	RD	RT	SCPDW	TOTSSS	VTK	WLI	
															STD				STD							

### Construction Upgrades

APC	PE
-----	----

### Door Options

DPSRR	MFO
-------	-----

## REMOVABLE VANITY SINK BASE, 21" DEEP

30", 33", or 36"

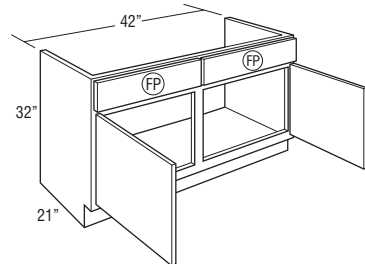
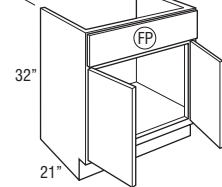

## RVWS3032

## RVWS3332

## RVWS3632

## RVWS4232

- Must be ordered with Vanity Wall Sink (VWS..23), not designed to be a stand-alone unit.
  - RVWS3032 is compatible with VWS2723
  - RVWS3332 is compatible with VWS3023
  - RVWS3632 is compatible with VWS3323
  - RVWS4232 is compatible with VWS3923
- Cabinet is able to be removed for handicap accessible use.
- Includes connector clips to mount the sink base to the Vanity Wall Sink (VWS..23).
- Available with AUTHL, AUTHR, and AUTHB modifications.

### Custom Modifications

ACS	CBD	CCO	CFNTO	CFP	CFRMO	CMAT	CND	DRT	DRWPWR	DRWSEC	EXBK	EX	FB	FD	FPFB	ID	INVFRM	LTI	MIP	RD	RT	SCPDW	TOTSSS	VTK	WLI	
			•	•	STD	•	•					•			STD				•	•						•

### Construction Upgrades

APC	PE
STD	

### Door Options

DPSRR	MFO
•	

TALL CABINET NOMENCLATURE

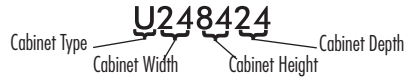

NOTE:  
Any included shelves on tall cabinets are packaged separately.

MODIFICATIONS GRID KEY

- Available
- STD Standard on these cabinets

CUSTOM MODIFICATIONS			CONSTRUCTION UPGRADES			DOOR OPTIONS	
Mod.	Description	Mod.	Description	Mod.	Description	Mod.	Description
ACS	Appliance Cut-out, Single	EXBKL	End Extended Back - Left	FTKFV	Flush Toekick Furniture	APC	All-plywood Construction
ADDTK	Add Toekick	EXBKR	End Extended Back - Right	ID	Increased Depth	ET	EasyTrax™
AUTHB	Authentic Ends - Both	EXL	Extended Sisle - Left	INVFRM	Inverted Frame	PE	Plywood Ends
AUTHL	Authentic End - Left	EXR	Extended Sisle - Right	MIP	Matching Interior Plywood		
AUTHR	Authentic End - Right	FB	Finished Ends	RD	Reduced Depth		
CBO	Cabinet Box Only	FD	Full Depth Shelf	RECTKL	Recessed Toekick - Left		
CCO	Cabinet Case Only	FFDL	Face Frame and Door on End - Left	RECTKR	Recessed Toekick - Right		
CFNTO	Cabinet Front Only			RT	Installed Roll Tray	CG.TOP	Cut-for-glass Doors
CFRMO	Cabinet Frame Only	FFDR	Face Frame and Door on End - Right	TD	Tray Dividers	DPSRR	Door Panel - Solid Reverse Raised
CND	Cabinet with No Door, with Drawer	FPEB	Furniture Finished Plywood Ends	TKP	Loose Toekick	MFO	Modified Full Overlay
DRT	Deep Roll Tray	FTK	Flush Toekick	VTK	Void Toekick		
DRWTK	Toekick Drawer	FTKAV	Flush Toekick Arch	WLI	White Laminate Interior		

UTILITY, 66" TALL, 12" DEEP

9", 12", 15", 18", 21", or 24"

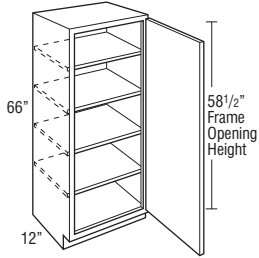

24", 27", 30", 33", or 36"

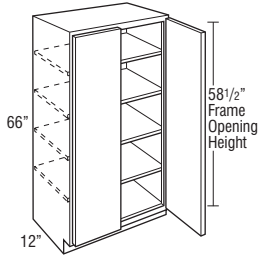

- U96612 L or R
- U126612 L or R
- U156612 L or R
- U186612 L or R
- U216612 L or R
- U246612 L or R

- U246612
- U276612
- U306612
- U336612
- U366612

- Recommended for stacking with wall cabinets to create tall utility cabinets for designs greater than 96".
- Utility cabinets with depths of 12" or less must be installed to wall studs or onto the end of another tall cabinet.
- Depth can be reduced to a minimum of 6". For depths of 6"-8", cabinet will not include toekick/pedestal.
- Tall non-mitered doors will have two center panels with cross rail.
- Door 33 doors greater than 48" high will be two doors doweled together.
- Because of exposed seam when stacking, FPEB is not recommended.
- Be sure to use an end panel skin to connect the seam on the side of the stacked cabinets.

Custom Modifications

ACS	ADDTK	AUTH	CBO	CCO	CFNTO	CFRMO	CND	DRT	DRWTK	EXBK	EX	FB	FFD	FPEB	FTK	FTK_V	ID	INVFRM	MIP	RD	RECTK_L	RT	TD	TKP	VTK	WLI
																*										

\*Not available on 9" and 12" wide

Construction Upgrades

APC	ET	PE
•		•

Door Options

CG.TOP	DPSRR	MFO
	•	•

**UTILITY, 66" TALL, 24" DEEP**

9", 12", 15", 18", 21", or 24"

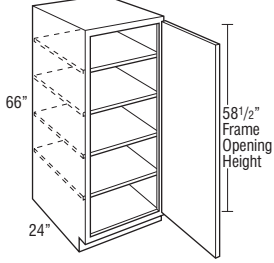

24", 27", 30", 33", or 36"

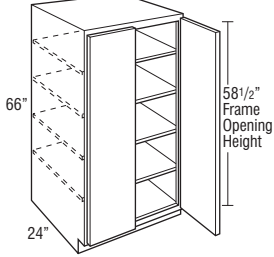

- U96624 L or R**
- U126624 L or R**
- U156624 L or R**
- U186624 L or R**
- U216624 L or R**
- U246624 L or R**

- U246624**
- U276624**
- U306624**
- U336624**
- U366624**

- Recommended for stacking with wall cabinets to create tall utility cabinets for designs greater than 96".
- Depth can be reduced to a minimum of 6". For depths of 6"-8", cabinet will not include toekick/pedestal.
- Tall non-mitered doors will have two center panels with cross rail.
- Door 33 doors greater than 48" high will be two doors doweled together.
- Because of exposed seam when stacking, FPEB is not recommended.
- Be sure to use an end panel skin to connect the seam on the side of the stacked cabinets.

**Custom Modifications**

ACS	ADDTK	AUTH	CBO	CCO	CFNTO	CFRMO	CND	DRT	DRWTK	EXBK	EX	FB	FFD	FPEB	FTK	FTK_V	ID	INVERM	MIP	RD	RECTK_	RT	TD	TKP	VTK	WLI
			•	•	•	•	•		•*	•	•	•	•	•	•	•*	•		•	•	•	•▲	•	•	•	

\*Not available on 9", 12", and 15" wide    \*Not available on 9" and 12" wide    ▲Not available on 9" wide

**Construction Upgrades**

APC	ET	PE
•		•

**Door Options**

CG.TOP	DPSRR	MFO
	•	•

**UTILITY, 84", 87", or 90" TALL,  
12" DEEP**

9", 12", 15", 18", 21", or 24"

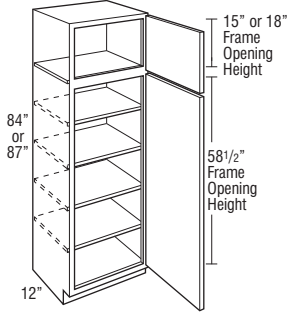

24", 27", 30", 33", or 36"

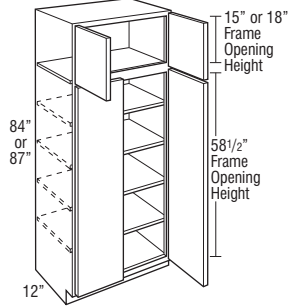

9", 12", 15", 18", 21", or 24"

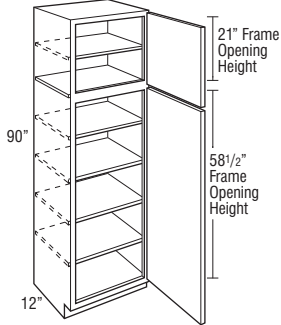

24", 27", 30", 33", or 36"

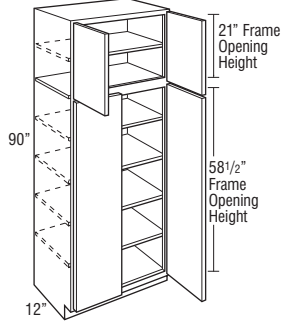

- U98412 L or R
- U128412 L or R
- U158412 L or R
- U188412 L or R
- U218412 L or R
- U248412 L or R
- U98712 L or R
- U128712 L or R
- U158712 L or R
- U188712 L or R
- U218712 L or R
- U248712 L or R

- U248412
- U278412
- U308412
- U338412
- U368412
- U248712
- U278712
- U308712
- U338712
- U368712

- U99012 L or R
- U129012 L or R
- U159012 L or R
- U189012 L or R
- U219012 L or R
- U249012 L or R

- U249012
- U279012
- U309012
- U339012
- U369012

- Utility cabinets with depths of 12" or less must be installed to wall studs or onto the end of another tall cabinet.
- Depth can be reduced to a minimum of 6". For depths of 6"-8", cabinet will not include toekick/pedestal.
- Tall non-mitered doors will have two center panels with cross rail.
- Door 33 doors greater than 48" high will be two doors doweled together.

**Custom Modifications**

ACS	ADDTK	AUTH	CBO	CCO	CFNTD	CFRMO	CND	DRT	DRWTK	EXBK	EX	FB	FFD	FPFB	FTK	FTK_V	ID	INVFRM	MIP	RD	RECTK	RT	TD	TKP	VTK	WLI	
																*											

\*Not available on 9" and 12" wide

**Construction Upgrades**

APC	ET	PE

**Door Options**

CG.TOP	DPSRR	MFO

**UTILITY, 93" or 96" TALL,  
12" DEEP**

9", 12", 15", 18", 21", or 24"

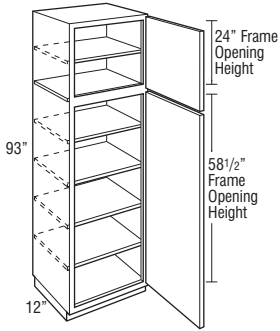

24", 27", 30", 33", or 36"

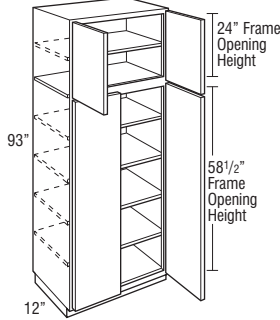

9", 12", 15", 18", 21", or 24"

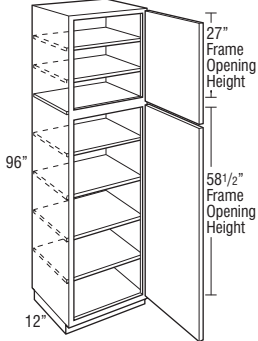

24", 27", 30", 33", or 36"

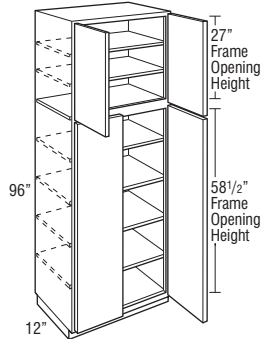

- U99312 L or R
- U129312 L or R
- U159312 L or R
- U189312 L or R
- U219312 L or R
- U249312 L or R

- U249312
- U279312
- U309312
- U339312
- U369312

- U99612 L or R
- U129612 L or R
- U159612 L or R
- U189612 L or R
- U219612 L or R
- U249612 L or R

- U249612
- U279612
- U309612
- U339612
- U369612

- Separate pedestal base included but packaged separately on 93" and 96" tall. Pedestal is designed to create a Recessed Left or Right Toekick application during field installation, or can be centered. Pedestal must be covered with toeboard material.
- Utility cabinets with depths of 12" or less must be installed to wall studs or onto the end of another tall cabinet.
- Depth can be reduced to a minimum of 6". For depths of 6"-8", cabinet will not include toekick/pedestal.
- Tall non-mitered doors will have two center panels with cross rail.
- Door 33 doors greater than 48" high will be two doors doweled together.

**Custom Modifications**

ACS	ADDTK	AUTH	CBO	CCO	CFNT0	CFRMO	CND	DRT	DRWTK	EXBK	EX	FB	FFD	FPEB	FTK	FTK_V	ID	INVFRM	MIP	RD	RECTK	RT	TD	TKP	VTK	WLI
			•	•	•		•			•	•	•	•	•	•	•*		•	•	•	•	•	•	•	•	•

\*Not available on 9" and 12" wide

**Construction Upgrades**

APC	ET	PE
•		•

**Door Options**

CG.TOP	DPSRR	MFO
•	•	•

**UTILITY, 84", 87", or 90" TALL, 24" DEEP**

9", 12", 15", 18", 21", or 24"

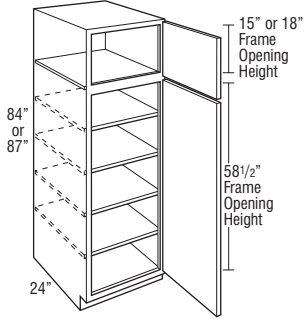

24", 27", 30", 33", or 36"

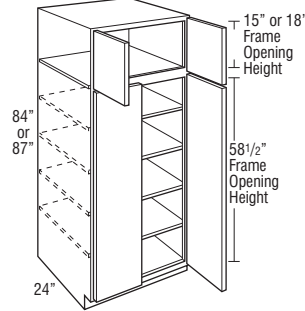

9", 12", 15", 18", 21", or 24"

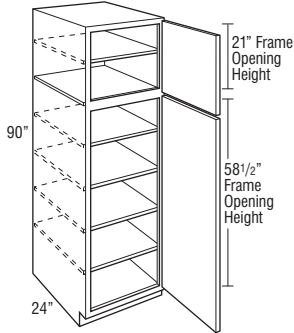

24", 27", 30", 33", or 36"

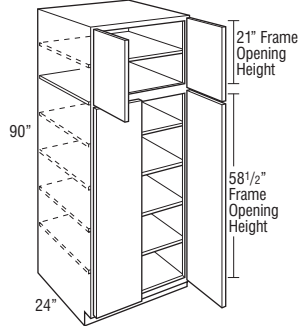

- U98424 L or R
- U128424 L or R
- U158424 L or R
- U188424 L or R
- U218424 L or R
- U248424 L or R
- U98724 L or R
- U128724 L or R
- U158724 L or R
- U188724 L or R
- U218724 L or R
- U248724 L or R

- U248424
- U278424
- U308424
- U338424
- U368424
- U248724
- U278724
- U308724
- U338724
- U368724

- U99024 L or R
- U129024 L or R
- U159024 L or R
- U189024 L or R
- U219024 L or R
- U249024 L or R

- U249024
- U279024
- U309024
- U339024
- U369024

- Depth can be reduced to a minimum of 6". For depths of 6"-8", cabinet will not include toekick/pedestal.
- Tall non-mitered doors will have two center panels with cross rail.
- Door 33 doors greater than 48" high will be two doors doweled together.

**Custom Modifications**

ACS	ADDTK	AUTH	CBO	CCO	CFNTO	CFRMO	CND	DRT	DRWTK	EXBK	EX	FB	FFD	FPEB	FTK	FTK_V	ID	INVFRM	MIP	RD	RECTK_	RT	TD	TKP	VTK	WLI	

\*Not available on 9", 12", and 15" wide    \*Not available on 9" and 12" wide    ▲Not available on 9" wide

**Construction Upgrades**

APC	ET	PE

**Door Options**

CG.TOP	DPSRR	MFO



**UTILITY, 93" or 96" TALL,  
24" DEEP**

9", 12", 15", 18", 21", or 24"

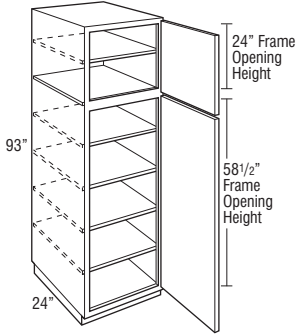

24", 27", 30", 33", or 36"

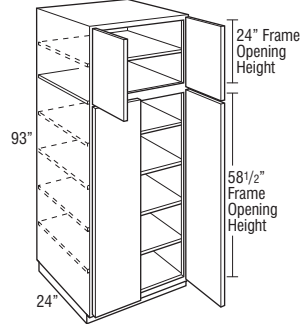

9", 12", 15", 18", 21", or 24"

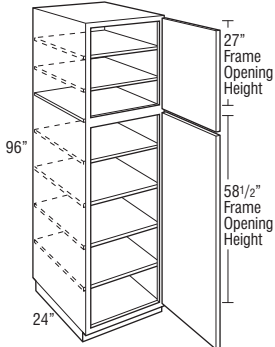

24", 27", 30", 33", or 36"

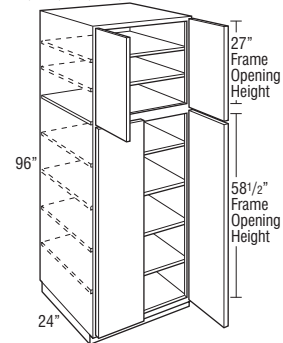

- U99324 L or R**
- U129324 L or R**
- U159324 L or R**
- U189324 L or R**
- U219324 L or R**
- U249324 L or R**

- U249324**
- U279324**
- U309324**
- U339324**
- U369324**

- U99624 L or R**
- U129624 L or R**
- U159624 L or R**
- U189624 L or R**
- U219624 L or R**
- U249624 L or R**

- U249624**
- U279624**
- U309624**
- U339624**
- U369624**

- Separate pedestal base included but packaged separately on 93" and 96" tall. Pedestal is designed to create a Recessed Left or Right Toekick application during field installation, or can be centered. Pedestal must be covered with toeboard material.
- Depth can be reduced to a minimum of 6". For depths of 6"-8", cabinet will not include toekick/pedestal.
- Tall non-mitered doors will have two center panels with cross rail.
- Door 33 doors greater than 48" high will be two doors doweled together.

**Custom Modifications**

ACS	ADTK	AUTH	CBO	CCO	CFNTO	CFRMO	CND	DRT	DRWTK	EXBK	EX	FB	FFD	FPEB	FTK	FTK_V	ID	INVFRM	MIP	RD	RECTK_RT	TD	TKP	VTK	WLI
			•	•	•	•				•	•	•	•	•	•	•*	•	•	•	•	•	•*	•	•	•

\*Not available on 9" and 12" wide

\*Not available on 9" wide

**Construction Upgrades**

APC	ET	PE
•		•

**Door Options**

CG.TOP	DPSRR	MFO
•	•	•

**UTILITY with ROLL TRAYS,  
66" TALL, 24" DEEP**

12", 15", 18", 21", or 24"

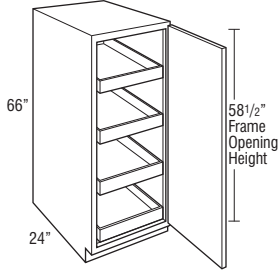

24", 27", 30", 33", or 36"

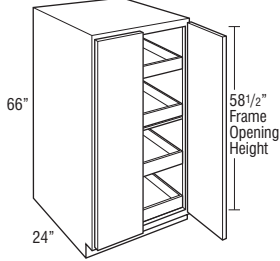

- U126624RT L or R**
- U156624RT L or R**
- U186624RT L or R**
- U216624RT L or R**
- U246624RT L or R**

- U246624RT**
- U276624RT**
- U306624RT**
- U336624RT**
- U366624RT**

- Recommended for stacking with wall cabinets to create tall utility cabinets for designs greater than 96".
- Four roll trays are included, installed in cabinet.
- Depth can be reduced to a minimum of 12".
- Tall non-mitered doors will have two center panels with cross rail.
- Door 33 doors greater than 48" high will be two doors doweled together.
- Because of exposed seam when stacking, FPFB is not recommended.
- Be sure to use an end panel skin to connect the seam on the side of the stacked cabinets.

**Custom Modifications**

ACS	ADDTK	AUTH	CBO	CCO	CFNTD	CFRMO	CND	DRT	DRWTK	EXBK	EX	FB	FFD	FPFB	FTK	FTK_V	ID	INVFRM	MIP	RD	RECTK_	RT	TD	TKP	VTK	WLI
			•	•	•	•	•	•	•*	•	•	•	•	•	•	•	•	•	•	•	•	•	•	•	•	•

\*Not available on 12" and 15" wide

**Construction Upgrades**

APC	ET	PE
•	•	•

**Door Options**

CG.TOP	DPSRR	MFO
	•	•

**UTILITY with ROLL TRAYS,  
84", 87", or 90" TALL, 24" DEEP**

12", 15", 18", 21", or 24"

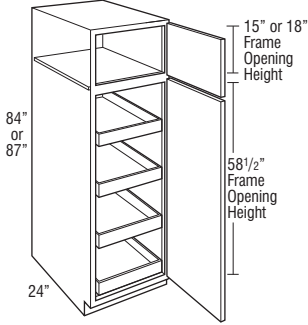

24", 27", 30", 33", or 36"

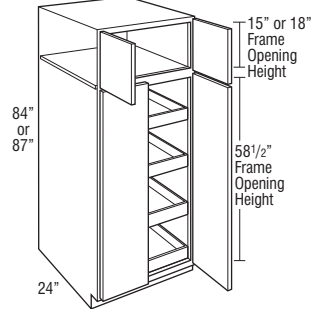

12", 15", 18", 21", or 24"

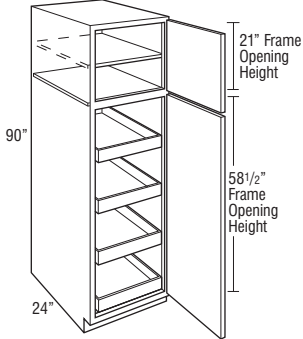

24", 27", 30", 33", or 36"

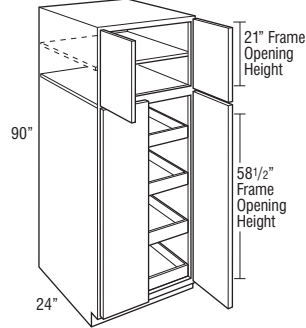

- U128424RT L or R
- U158424RT L or R
- U188424RT L or R
- U218424RT L or R
- U248424RT L or R
- U128724RT L or R
- U158724RT L or R
- U188724RT L or R
- U218724RT L or R
- U248724RT L or R

- U248424RT
- U278424RT
- U308424RT
- U338424RT
- U368424RT
- U248724RT
- U278724RT
- U308724RT
- U338724RT
- U368724RT

- U129024RT L or R
- U159024RT L or R
- U189024RT L or R
- U219024RT L or R
- U249024RT L or R

- U249024RT
- U279024RT
- U309024RT
- U339024RT
- U369024RT

- Four roll trays are included, installed in cabinet.
- Depth can be reduced to a minimum of 12".
- Tall non-mitered doors will have two center panels with cross rail.
- Door 33 doors greater than 48" high will be two doors doweled together.

**Custom Modifications**

ACS	ADDTK	AUTH	CBO	CCO	CFNTO	CFRMO	CND	DRT	DRWTK	EXBK	EX	FB	FFD	FPEB	FTK	FTK_V	ID	INVFRM	MIP	RD	RECTK_RT	TD	TKP	VTK	WLI
			•	•	•	•	•	•	•*	•	•	•	•	•	•	•	•			•	•	•	•	•	•

\*Not available on 12" and 15" wide

**Construction Upgrades**

APC	ET	PE
•	•	•

**Door Options**

CG.TOP	DPSRR	MFO
•	•	•

**UTILITY with ROLL TRAYS,  
93" or 96" TALL, 24" DEEP**

12", 15", 18", 21", or 24"

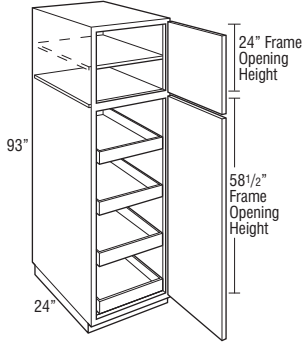

24", 27", 30", 33", or 36"

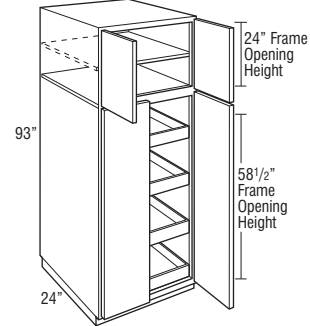

12", 15", 18", 21", or 24"

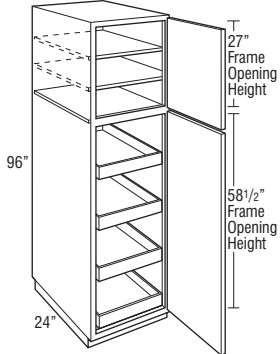

24", 27", 30", 33", or 36"

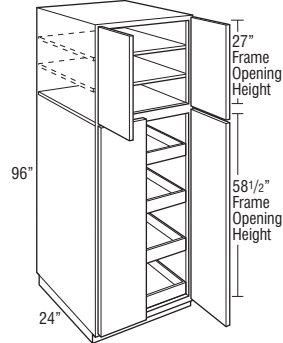

- U129324RT L or R
- U159324RT L or R
- U189324RT L or R
- U219324RT L or R
- U249324RT L or R

- U249324RT
- U279324RT
- U309324RT
- U339324RT
- U369324RT

- U129624RT L or R
- U159624RT L or R
- U189624RT L or R
- U219624RT L or R
- U249624RT L or R

- U249624RT
- U279624RT
- U309624RT
- U339624RT
- U369624RT

- Separate pedestal base included but packaged separately on 93" and 96" tall. Pedestal is designed to create a Recessed Left or Right Toekick application during field installation, or can be centered. Pedestal must be covered with toeboard material.
- Four roll trays are included, installed in cabinet.
- Depth can be reduced to a minimum of 12".
- Tall non-mitered doors will have two center panels with cross rail.
- Door 33 doors greater than 48" high will be two doors doweled together.

**Custom Modifications**

ACS	ADDTK	AUTH	CBO	CCO	CFNT0	CFRMO	CND	DRT	DRWTK	EXBK	EX	FB	FFD	FPEB	FTK	FTK_V	ID	INVFRM	MIP	RD	RECTK_	RT	TD	TKP	VTK	WLI	
																*											

\*Not available on 12" wide

**Construction Upgrades**

APC	ET	PE

**Door Options**

CG.TOP	DPSRR	MFO

**UTILITY ORGANIZER CABINET,  
84", 87", 90", 93", or 96" TALL,  
6" DEEP, 24" WIDE**

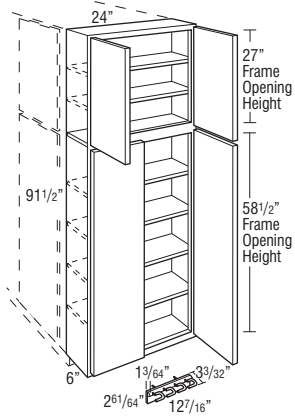
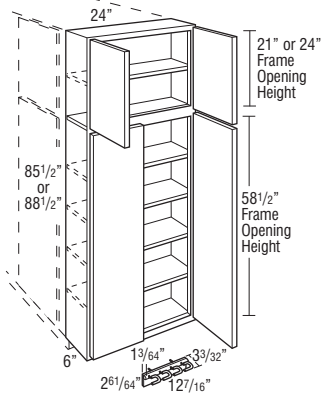
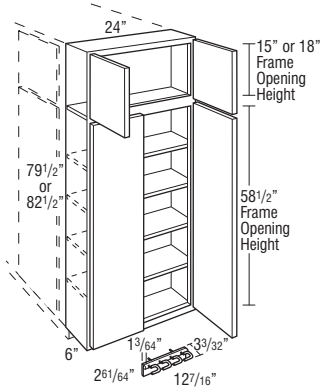

**UOC24846**

**UOC24876**

**UOC24906**

**UOC24936**

**UOC24966**

- Includes adjustable shelves and broom clip packaged separately (not installed):  
84"-87" tall - four shelves  
90"-93" tall - five shelves  
96" tall - six shelves
- Designed to be installed onto an adjacent 24" deep tall cabinet.
- For proper installation, adjacent cabinet must have FPEB or 1/4" skin applied.
- 6" overlay fillers can be used on the side to add a decorative touch (Full overlay door styles only).
- Utility cabinets with depths of 12" or less must be installed to wall studs or onto the end of another tall cabinet.
- Does not include toeboard or pedestal.
- Tall non-mitered doors will have two center panels with cross rail.
- Door 33 doors greater than 48" high will be two doors doweled together.

**Custom Modifications**

ACS	ADTK	AUTH	CBO	CCO	CFNTD	CFRMO	CND	DRT	DRWTK	EXBK	EX	FB	FFD	FPEB	FTK	FTK_V	ID	INFRM	MIP	RD	RECTK_RT	TD	TKP	VTK	WLI	
			•	•	•	•								STD					•	•						•

**Construction Upgrades**

APC	ET	PE
•		

**Door Options**

CG.TOP	DPSRR	MFO
•	•	•

**UTILITY ORGANIZER DROP ZONE  
CABINET, 84", 87", 90", 93", or  
96" HIGH, 9" DEEP, 24" WIDE**

232

TALL CABINETS

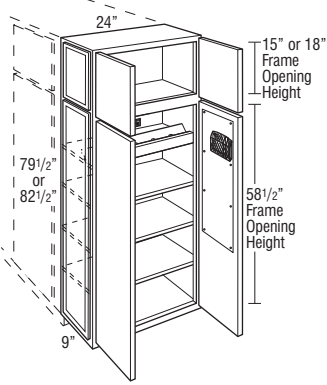
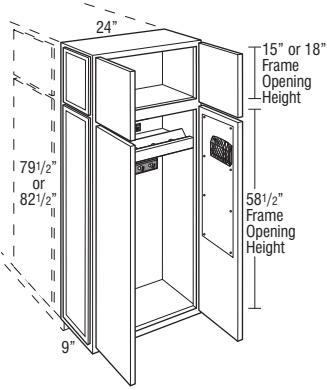

UOCDZ24849AEL/AER  
UOCDZ24879AEL/AER

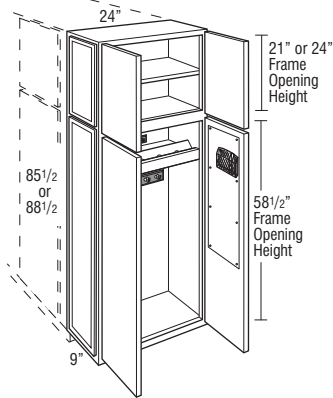

UOCDZ24909AEL/AER  
UOCDZ24939AEL/AER

UOCDZ24849AEL  
UOCDZ24849AER  
UOCDZ24879AEL  
UOCDZ24879AER

UOCDZ24909AEL  
UOCDZ24909AER  
UOCDZ24939AEL  
UOCDZ24939AER

UOCDZ24969AEL  
UOCDZ24969AER

- Features magnetic whiteboards on back of lower doors, one magnetic black mesh pencil holder, charging station with power strip, black plastic grommet for power cord, key hooks, and coat hooks. Accessories are field installed.
- Charging station functions as an adjustable shelf, features five cord cut-out areas and includes a UL listed power strip with three standard 110-volt plug-ins and one USB charging port.
- One adjustable shelf in upper section on 90" and 93", two adjustable shelves for 96", and three adjustable shelves in lower section.
- Authentic Ends are standard on one side. Specify AEL model for installation on the right side of a tall cabinet. Specify AER model for installation on the left side of a tall cabinet. Opposite end panel will feature FPFB construction (if decorative doors are desired on both sides of cabinet, order No Hinge Route doors for a Tall Pantry Pull-out).
- Designed to be installed onto an adjacent 24" deep tall cabinet.
- For proper installation, adjacent cabinet must have FPFB or 1/4" skin applied.
- Utility cabinets with depths of 12" or less must be installed to wall studs or onto the end of another tall cabinet.
- Does not include toeboard or pedestal.
- Tall non-mitered doors will have two center panels with cross rail.
- Door 33 doors greater than 48" high will be two doors doweled together.

**Custom Modifications**

ACS	ADDTK	AUTH	CBO	CCO	CFNTO	CFRMO	CND	DRT	DRWTK	EXBK	EX	FB	FFD	FPFB	FTK	FTK_V	ID	INVFRM	MIP	RD	RECTK	RT	TD	TKP	VTK	WLI	

**Construction Upgrades**

APC	ET	PE

**Door Options**

CG.TOP	DPSRR	MFO

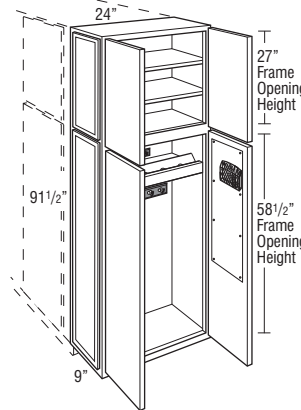
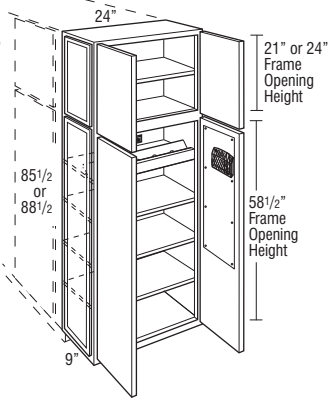

UOCDZ24969EL/AER

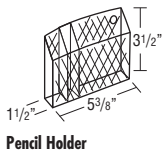
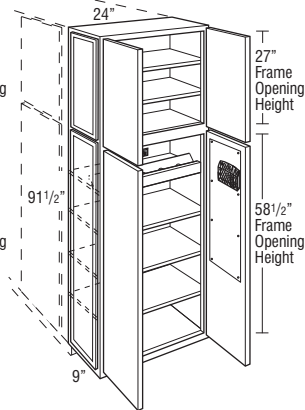

Pencil Holder

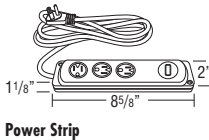

Power Strip



Grommet



Key Hooks



Coat Hooks

**PANTRY TOP UNIT with SHELVES, SINGLE DOOR, 24" DEEP**

15", 18", 21", or 24"

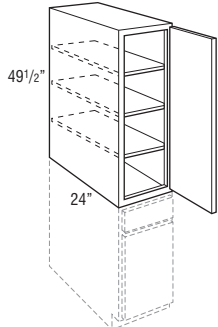

15", 18", 21", or 24"

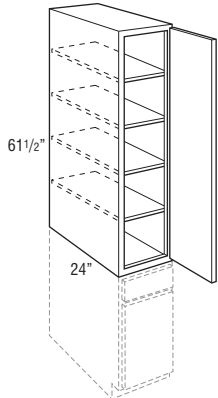

- PTUS154924 L or R
- PTUS184924 L or R
- PTUS214924 L or R
- PTUS244924 L or R

- PTUS156124 L or R
- PTUS186124 L or R
- PTUS216124 L or R
- PTUS246124 L or R

- Three adjustable shelves included with 49 1/2" high, and four adjustable shelves included with 61 1/2" high.
- Sets on any 15", 18", 21", or 24" wide base (B15 shown). No countertop is needed.
- Can be reduced in depth to 6".
- Because of exposed seam when stacking, FPEB is not recommended.
- Be sure to use an end panel skin to connect the seam on the side of the stacked cabinets.
- Tall non-mitered doors will have two center panels with cross rail.
- Door 33 doors will be two doors doweled together.

**Custom Modifications**

ACS	ADTK	AUTH	CBO	CCO	CFNT0	CFRMO	CND	DRT	DRWTK	EXBK	EX	FB	FFD	FPEB	FTK	FTK_V	ID	INVFRM	MIP	RD	RECTK_	RT	TD	TKP	VTK	WLI	
		•*																			•*						

\*RD12 is not compatible with AUTHL, AUTHR, or AUTHB

**Construction Upgrades**

APC	ET	PE

**Door Options**

CG.TOP	DPSRR	MFO

**PANTRY TOP UNIT with SHELVES, DOUBLE DOOR, 24" DEEP**

24", 30", or 36"

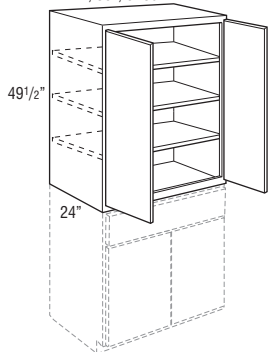

24", 30", or 36"

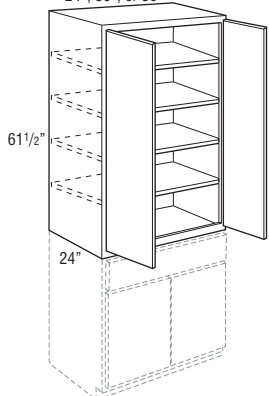

- PTUS244924
- PTUS304924
- PTUS364924

- PTUS246124
- PTUS306124
- PTUS366124

- Three adjustable shelves included with 49 1/2" high, and four adjustable shelves included with 61 1/2" high.
- Sets on any 24", 30", or 36" wide base (B30 shown). No countertop is needed.
- Can be reduced in depth to 6".
- Because of exposed seam when stacking, FPEB is not recommended.
- Be sure to use an end panel skin to connect the seam on the side of the stacked cabinets.
- Tall non-mitered doors will have two center panels with cross rail.
- Door 33 doors will be two doors doweled together.

**Custom Modifications**

ACS	ADTK	AUTH	CBO	CCO	CFNT0	CFRMO	CND	DRT	DRWTK	EXBK	EX	FB	FFD	FPEB	FTK	FTK_V	ID	INVFRM	MIP	RD	RECTK_	RT	TD	TKP	VTK	WLI	
		•*																			•*						

\*RD12 is not compatible with AUTHL, AUTHR, or AUTHB

**Construction Upgrades**

APC	ET	PE

**Door Options**

CG.TOP	DPSRR	MFO

**PANTRY TOP UNIT,  
SINGLE DOOR, 24" DEEP**

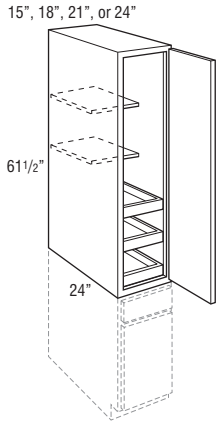
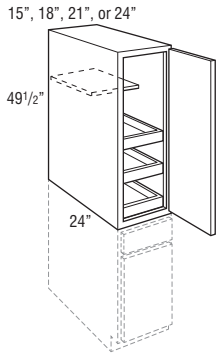

- PTU154924 L or R
- PTU184924 L or R
- PTU214924 L or R
- PTU244924 L or R

- PTU156124 L or R
- PTU186124 L or R
- PTU216124 L or R
- PTU246124 L or R

- One 15" deep adjustable shelf included with 49 1/2" high, and two 15" deep adjustable shelves included with 61 1/2" high.
- Three roll trays are included, installed in cabinet.
- Sets on any 15", 18", 21", or 24" wide base (B15 shown). No countertop is needed.
- Can be reduced in depth to 12".
- Because of exposed seam when stacking, FPEB is not recommended.
- Be sure to use an end panel skin to connect the seam on side of stacked cabinets.
- Tall non-mitered doors will have two center panels with cross rail.
- Door 33 doors will be two doors doweled together.

**Custom Modifications**

ACS	ADDTK	AUTH	CBO	CCO	CFNT0	CFRMO	CND	DRT	DRWTK	EXBK	EX	FB	FD	FFD	FPEB	FTK	FTK_V	ID	INVFRM	MIP	RD	RECTK_	RT	TD	TKP	VTK	WLL
		•*																			•*						

\*RD12 is not compatible with AUTHL, AUTHR, or AUTHB

**Construction Upgrades**

APC	ET	PE
•		•

**Door Options**

CG.TOP	DPSRR	MFO
	•	•

**PANTRY TOP UNIT,  
DOUBLE DOOR, 24" DEEP**

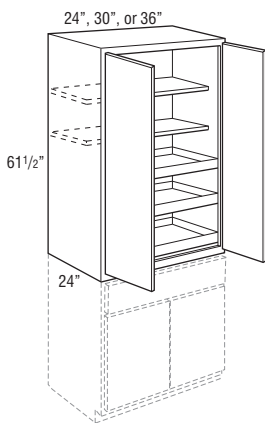
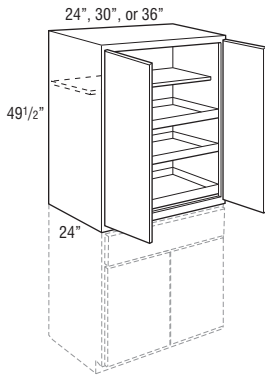

- PTU244924
- PTU304924
- PTU364924

- PTU246124
- PTU306124
- PTU366124

- One 15" deep adjustable shelf included with 49 1/2" high, and two 15" deep adjustable shelves included with 61 1/2" high.
- Three roll trays are included, installed in cabinet.
- Sets on any 24", 30", or 36" wide base. (B30 shown.) No countertop is needed.
- Can be reduced in depth to 12".
- Because of exposed seam when stacking, FPEB is not recommended.
- Be sure to use an end panel skin to connect the seam on side of stacked cabinets.
- Tall non-mitered doors will have two center panels with cross rail.
- Door 33 doors will be two doors doweled together.

**Custom Modifications**

ACS	ADDTK	AUTH	CBO	CCO	CFNT0	CFRMO	CND	DRT	DRWTK	EXBK	EX	FB	FD	FFD	FPEB	FTK	FTK_V	ID	INVFRM	MIP	RD	RECTK_	RT	TD	TKP	VTK	WLL
		•*																			•*						

\*RD12 is not compatible with AUTHL, AUTHR, or AUTHB

**Construction Upgrades**

APC	ET	PE
•		•

**Door Options**

CG.TOP	DPSRR	MFO
	•	•



**TALL PANTRY PULL-OUT,  
84", 87", or 90" TALL, 24" DEEP**

9", 12", 15", or 18"

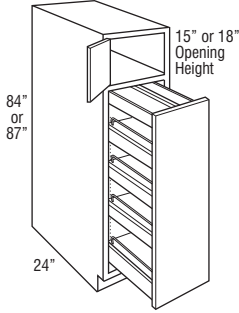

9", 12", 15", or 18"

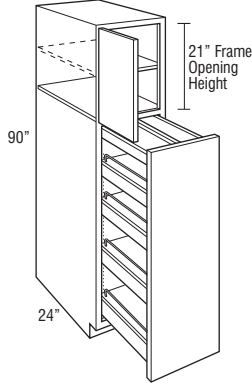

- TPP98424 L or R
- TPP128424 L or R
- TPP158424 L or R
- TPP188424 L or R
- TPP98724 L or R
- TPP128724 L or R
- TPP158724 L or R
- TPP188724 L or R

- TPP99024 L or R
- TPP129024 L or R
- TPP159024 L or R
- TPP189024 L or R

- Three adjustable shelves and one fixed bottom shelf with metallic finish wire rail sides. Natural finish wood pull-out shelves are 20 11/16" deep. Pull-out features top/bottom mounted soft-close full extension guides.
- 84" and 87" high do not include shelves in upper section. Upper section 15" or 18".
- Tall non-mitered doors will have two center panels with cross rail.
- Door 33 doors greater than 48" high will be two doors doweled together.
- For full access from both sides of unit, do not install against a wall or next to deeper appliances and cabinets.
- Pull-out mechanism not available for order for field installation, only available factory installed.

**Custom Modifications**

ACS	ADDTK	AUTH	CBO	CCO	CFNTO	CFRMO	CND	DRT	DRWTK	EXBK	EX	FB	FFD	FPEB	FTK	FTK_V	ID	INVFRM	MIP	RD	RECTK_	RT	TD	TKP	VTK	WLI
			•	•					•*	•	•	•			•	•	•*			•		•	•	•	•	•

\*Available only on 18" wide \*Not available on 9" and 12" wide

**Construction Upgrades**

APC	ET	PE
•		•

**Door Options**

CG.TOP	DPSRR	MFO
•	•	•

**TALL PANTRY PULL-OUT,  
93" or 96" TALL, 24" DEEP**

9", 12", 15", or 18"

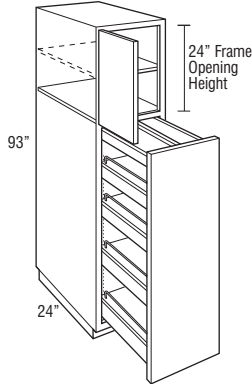

9", 12", 15", or 18"

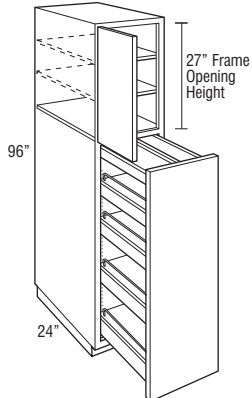

- TPP99324 L or R
- TPP129324 L or R
- TPP159324 L or R
- TPP189324 L or R

- TPP99624 L or R
- TPP129624 L or R
- TPP159624 L or R
- TPP189624 L or R

- Three adjustable shelves and one fixed bottom shelf with metallic finish wire rail sides. Natural finish wood pull-out shelves are 20 11/16" deep. Pull-out features top/bottom mounted soft-close full extension guides.
- Separate pedestal base included but packaged separately on 93" and 96" tall. Pedestal is designed to create a Recessed Left or Right Toekick application during field installation, or can be centered. Pedestal must be covered with toeboard material.
- Tall non-mitered doors will have two center panels with cross rail.
- Door 33 doors greater than 48" high will be two doors doweled together.
- For full access from both sides of unit, do not install against a wall or next to deeper appliances and cabinets.
- Pull-out mechanism not available for order for field installation, only available factory installed.

**Custom Modifications**

ACS	ADDTK	AUTH	CBO	CCO	CFNTO	CFRMO	CND	DRT	DRWTK	EXBK	EX	FB	FFD	FPEB	FTK	FTK_V	ID	INVFRM	MIP	RD	RECTK_	RT	TD	TKP	VTK	WLI
			•	•	•					•	•	•			•	•	•*			•		•	•	•	•	•

\*Not available on 9" and 12" wide

**Construction Upgrades**

APC	ET	PE
•		•

**Door Options**

CG.TOP	DPSRR	MFO
•	•	•

**PANTRY UNIT,  
84", 87", or 90" TALL, 24" DEEP**

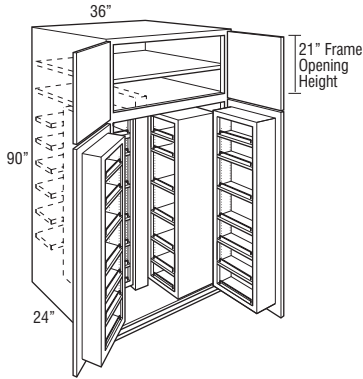
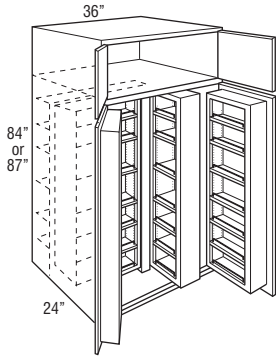

**PY368424**  
**PY368724**

**PY369024**

- Shelves on swing-out units, mounting rails, and door racks have a furniture board core with natural finish wood fronts and metallic finish wire rails. Door mounted rack includes 6 adjustable shelves and one fixed shelf. Swing-outs include 4 adjustable shelves and 3 fixed shelves. Swing-out and door racks included but shipped separately for field installation, includes mounting screws and installation instructions. Adjustable shelves for use in back of cabinet are 4 1/2" deep, six included.
- Tall non-mitered doors will have two center panels with cross rail.
- Door 33 doors greater than 48" high will be two doors doweled together.

**Custom Modifications**

ACS	ADDTK	AUTH	CBO	CCO	CFNTO	CFRMO	CND	DRT	DRWTK	EXBK	EX	FB	FFD	FPFB	FTK	FTK_V	ID	INVFRM	MIP	RD	RECTK	RT	TD	TKP	VTK	WLI

**Construction Upgrades**

APC	ET	PE

**Door Options**

CG.TOP	DPSRR	MFO

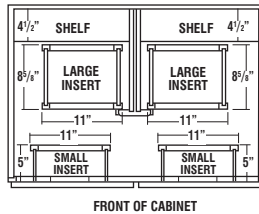

**Wood inserts for all styles:**

- Top view of wood inserts positioning and size.
- Wood inserts are 56" high.

**PANTRY UNIT,  
93" or 96" TALL, 24" DEEP**

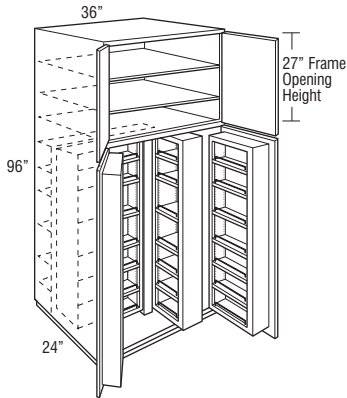
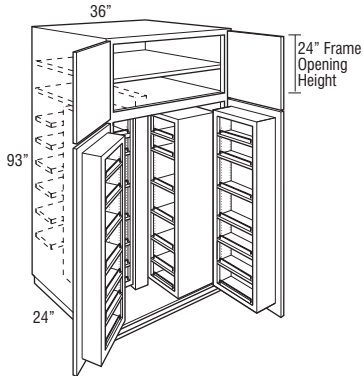

**PY369324**

**PY369624**

- Shelves on swing-out units, mounting rails, and door racks have a furniture board core with natural finish wood fronts and metallic finish wire rails. Door mounted rack includes 6 adjustable shelves and one fixed shelf. Swing-outs include 4 adjustable shelves and 3 fixed shelves. Swing-out and door racks included but shipped separately for field installation, includes mounting screws and installation instructions. Adjustable shelves for use in back of cabinet are 4 1/2" deep, six included.
- Separate pedestal base included but packaged separately on 93" and 96" tall. Pedestal is designed to create a Recessed Left or Right Toekick application during field installation, or can be centered. Pedestal must be covered with toeboard material.
- Tall non-mitered doors will have two center panels with cross rail.
- Door 33 doors greater than 48" high will be two doors doweled together.

**Custom Modifications**

ACS	ADDTK	AUTH	CBO	CCO	CFNTO	CFRMO	CND	DRT	DRWTK	EXBK	EX	FB	FFD	FPFB	FTK	FTK_V	ID	INVFRM	MIP	RD	RECTK	RT	TD	TKP	VTK	WLI

**Construction Upgrades**

APC	ET	PE

**Door Options**

CG.TOP	DPSRR	MFO

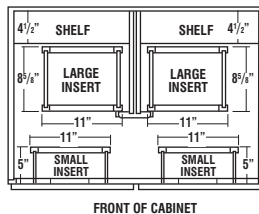

**Wood inserts for all styles:**

- Top view of wood inserts positioning and size.
- Wood inserts are 56" high.

**PANTRY WALK-THROUGH,  
84", 87", 90", 93", or 96" TALL,  
24" DEEP**

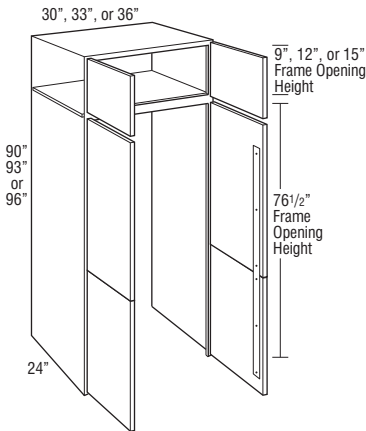
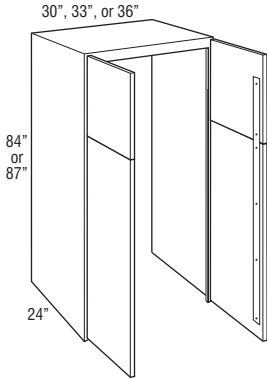

PWT308424  
PWT338424  
PWT368424  
PWT308724  
PWT338724  
PWT368724

PWT309024  
PWT339024  
PWT369024  
PWT309324  
PWT339324  
PWT369324  
PWT309624  
PWT339624  
PWT369624

- Cabinet does not have a bottom. 84" and 87" high do not have a back, 90"-96" high only have a back in the upper section. Doors are braced together, are 1/4" shorter than the cabinet for floor clearance, and use standard 107° smart close hinges.
- Not available in Door 37 and Door 44.
- Can be reduced in depth to 9" or increased in depth to 27".
- CG and glass inserts only available on upper doors of 90"-96" tall.
- Authentic Ends uses the standard tall door configuration by height and will not align with the front doors. A tall end panel skin can be used to conceal door attachment screws on the interior of the cabinet end panel (see TEPS\_\_WD on page 313).
- Height of ceiling needs to be considered for installation, 96" high cabinet requires 99" of height for 24" deep and 100" of height for 27" deep to stand unit upright.
- Cabinet will be shipped with additional attached supports to be removed during installation.
- ICM8 (Inside Corner Moulding) can be used to conceal staples behind the face frame.
- SCRIBE8 (Small Scribe Moulding) can be used to conceal exposed back edges of the end panels, which are not edgebanded.
- End panels will not be drilled for shelves.

	FO Door Height			MFO Door Height		
	Top Door	Middle Door	Bottom Door	Top Door	Middle Door	Bottom Door
PWT308424	22 1/2"	N/A	61"	21 3/4"	N/A	61"
PWT338424	22 1/2"	N/A	61"	21 3/4"	N/A	61"
PWT368424	22 1/2"	N/A	61"	21 3/4"	N/A	61"
PWT308724	25 1/2"	N/A	61"	24 3/4"	N/A	61"
PWT338724	25 1/2"	N/A	61"	24 3/4"	N/A	61"
PWT368724	25 1/2"	N/A	61"	24 3/4"	N/A	61"
PWT309024	11 1/2"	43 1/2"	34"	10 3/4"	43 1/2"	34"
PWT339024	11 1/2"	43 1/2"	34"	10 3/4"	43 1/2"	34"
PWT369024	11 1/2"	43 1/2"	34"	10 3/4"	43 1/2"	34"
PWT309324	14 1/2"	43 1/2"	34"	13 3/4"	43 1/2"	34"
PWT339324	14 1/2"	43 1/2"	34"	13 3/4"	43 1/2"	34"
PWT369324	14 1/2"	43 1/2"	34"	13 3/4"	43 1/2"	34"
PWT309624	17 1/2"	43 1/2"	34"	16 3/4"	43 1/2"	34"
PWT339624	17 1/2"	43 1/2"	34"	16 3/4"	43 1/2"	34"
PWT369624	17 1/2"	43 1/2"	34"	16 3/4"	43 1/2"	34"

**Custom Modifications**

ACS	ADTK	AUTH	CBO	CCO	CFNTO	CFRMO	CND	DRT	DRWTK	EXBK	EX	FB	FFD	FPEB	FTK	FTK_V	ID	INVFRM	MIP	RD	RECTK_	RT	TD	TKP	VTK	WLI	

**Construction Upgrades**

APC	ET	PE
STD		

**Door Options**

CG.TOP	DPSRR	MFO
•†	•	•

†Available only on 90"-96" high

**SINGLE OVEN CABINET,  
84", 87", or 90" TALL, 24" DEEP**

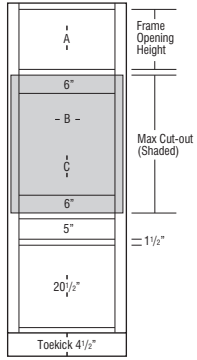
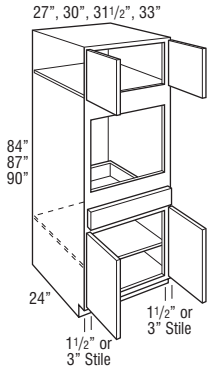

OSB\_ \_ \_ 24

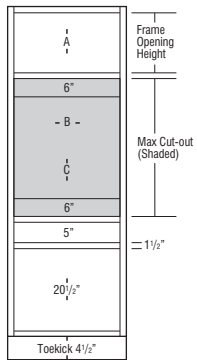

OSB\_ \_ \_ 24N

OSB278424(N)

OSB308424(N)

OSB31.58424(N)

OSB338424(N)

OSB278724(N)

OSB308724(N)

OSB31.58724(N)

OSB338724(N)

OSB279024(N)

OSB309024(N)

OSB31.59024(N)

OSB339024(N)

- N represents Narrow Stile cabinets with 1 1/2" wide face frame side stiles and ACS modification availability (see page 48 for ACS specifications). Doors and drawer fronts have a consistent 1/4" width reveal and use standard smart close hinges.
- On cabinets with 3" wide face frame side stiles, doors use face mount hinges. Doors and drawer fronts have a consistent 1/4" width reveal.
- Cabinets with 3" wide face frames are not available in Door 37 Decorative Laminate, or Door 15, Door 18, and Door 32 MDF door styles.
- Base section will utilize a full depth shelf.
- All top and bottom cross rails are 1 1/2" wide.
- Be sure to confirm a heat shield is built into your appliance by the manufacturer or install the heat shield included with your appliance. Heat shields are sold separately as an accessory.
- Depth can be reduced to a minimum of 12".
- For built-in appliance support, OCINSTALKIT is included in 24" deep oven cabinets (see page 373 for details). Oven install kit will not be included when depth is modified.
- OCINSTALKIT weight limit is 400 lbs. per pair.
- Oven cabinets feature an open back in cut-out area designed to improve field appliance installation.
- Maximum cut-out dimension will allow 1/4" reveal for doors and drawer fronts for trim kit face clearance.

	A Frame Opening Height	B Cut-out Width		C Cut-out Height		Door Height (Upper Section) Full Overlay
		Min.	Max.	Min.	Max.	
OSB278424	15"	21"	25 1/2"	22 1/2"	31 1/2"	17 1/2"
OSB308424	15"	24"	28 1/2"	22 1/2"	31 1/2"	17 1/2"
OSB31.58424	15"	25 1/2"	30"	22 1/2"	31 1/2"	17 1/2"
OSB338424	15"	27"	31 1/2"	22 1/2"	31 1/2"	17 1/2"
OSB278724	18"	21"	25 1/2"	22 1/2"	31 1/2"	20 1/2"
OSB308724	18"	24"	28 1/2"	22 1/2"	31 1/2"	20 1/2"
OSB31.58724	18"	25 1/2"	30"	22 1/2"	31 1/2"	20 1/2"
OSB338724	18"	27"	31 1/2"	22 1/2"	31 1/2"	20 1/2"
OSB279024	21"	21"	25 1/2"	22 1/2"	31 1/2"	23 1/2"
OSB309024	21"	24"	28 1/2"	22 1/2"	31 1/2"	23 1/2"
OSB31.59024	21"	25 1/2"	30"	22 1/2"	31 1/2"	23 1/2"
OSB339024	21"	27"	31 1/2"	22 1/2"	31 1/2"	23 1/2"

	A Frame Opening Height	B Cut-out Width (standard)		B Cut-out Width (with ACS modification)			C Cut-out Height		Door Height (Upper Section) Full Overlay
		Min.	Max.	Min.	Max.	Max. w/ Field Cut	Min.	Max.	
OSB278424N	15"	24"	25 1/2"	21"	24"	25 1/2"	22 1/2"	31 1/2"	17 1/2"
OSB308424N	15"	27"	28 1/2"	24"	27"	28 1/2"	22 1/2"	31 1/2"	17 1/2"
OSB31.58424N	15"	28 1/2"	30"	25 1/2"	28 1/2"	30"	22 1/2"	31 1/2"	17 1/2"
OSB338424N	15"	30"	31 1/2"	27"	30"	31 1/2"	22 1/2"	31 1/2"	17 1/2"
OSB278724N	18"	24"	25 1/2"	21"	24"	25 1/2"	22 1/2"	31 1/2"	20 1/2"
OSB308724N	18"	27"	28 1/2"	24"	27"	28 1/2"	22 1/2"	31 1/2"	20 1/2"
OSB31.58724N	18"	28 1/2"	30"	25 1/2"	28 1/2"	30"	22 1/2"	31 1/2"	20 1/2"
OSB338724N	18"	30"	31 1/2"	27"	30"	31 1/2"	22 1/2"	31 1/2"	20 1/2"
OSB279024N	21"	24"	25 1/2"	21"	24"	25 1/2"	22 1/2"	31 1/2"	23 1/2"
OSB309024N	21"	27"	28 1/2"	24"	27"	28 1/2"	22 1/2"	31 1/2"	23 1/2"
OSB31.59024N	21"	28 1/2"	30"	25 1/2"	28 1/2"	30"	22 1/2"	31 1/2"	23 1/2"
OSB339024N	21"	30"	31 1/2"	27"	30"	31 1/2"	22 1/2"	31 1/2"	23 1/2"

**Custom Modifications**

ACS	ADDTK	AUTH	CBO	CCO	CFNTO	CFRMO	CND	DRT	DRWTK	EXBK	EX	FB	FFD	FPEB	FTK	FTK_V	ID	INVFRM	MIP	RD	RECTK_	RT	TD	TKP	VTK	WLI	
•*																											

\*Only available on Narrow Stile (N) cabinets

**Construction Upgrades**

APC	ET	PE
•		•

**Door Options**

CG.TOP	DPSRR	MFO
•†	•	•

†Only available on Narrow Stile (N) cabinets

**SINGLE OVEN CABINET,  
93" or 96" TALL, 24" DEEP**

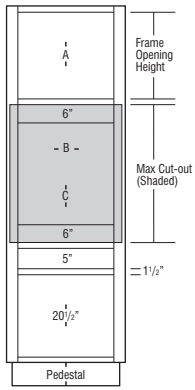
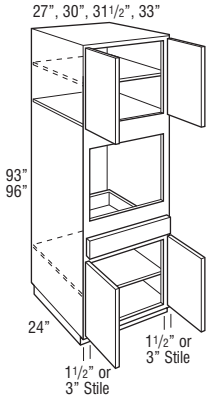

OSB \_ \_ \_ 24

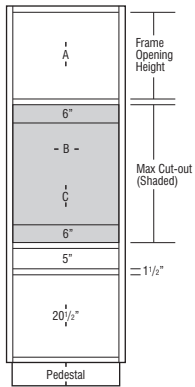

OSB \_ \_ \_ 24N

- OSB279324(N)
- OSB309324(N)
- OSB31.59324(N)
- OSB339324(N)
- OSB279624(N)
- OSB309624(N)
- OSB31.59624(N)
- OSB339624(N)

- N represents Narrow Stile cabinets with 1 1/2" wide face frame side stiles and ACS modification availability (see page 48 for ACS specifications). Doors and drawer fronts have a consistent 1/4" width reveal and use standard smart close hinges.
- On cabinets with 3" wide face frame side stiles, doors use face mount hinges. Doors and drawer fronts have a consistent 1/4" width reveal.
- Cabinets with 3" wide face frames are not available in Door 37 Decorative Laminate, or Door 15, Door 18, and Door 32 MDF door styles.
- Base section will utilize a full depth shelf.
- Includes adjustable shelves in upper section:  
93" tall - one shelf  
96" tall - two shelves
- All top and bottom cross rails are 1 1/2" wide.
- Be sure to confirm a heat shield is built into your appliance by the manufacturer or install the heat shield included with your appliance. Heat shields are sold separately as an accessory.
- Separate pedestal base included but packaged separately on 93" and 96" tall. Pedestal is designed to create a Recessed Left or Right Toekick application during field installation, or can be centered. Pedestal must be covered with toeboard material.
- Depth can be reduced to a minimum of 12".
- For built-in appliance support, OCINSTALLKIT is included in 24" deep oven cabinets (see page 373 for details). Oven install kit will not be included when depth is modified.
- OCINSTALLKIT weight limit is 400 lbs. per pair.
- Oven cabinets feature an open back in cut-out area designed to improve field appliance installation.
- Maximum cut-out dimension will allow 1/4" reveal for doors and drawer fronts for trim kit face clearance.

	A Frame Opening Height	B Cut-out Width		C Cut-out Height		Door Height (Upper Section)
		Min.	Max.	Min.	Max.	Full Overlay
OSB279324	24"	21"	25 1/2"	22 1/2"	31 1/2"	26 1/2"
OSB309324	24"	24"	28 1/2"	22 1/2"	31 1/2"	26 1/2"
OSB31.59324	24"	25 1/2"	30"	22 1/2"	31 1/2"	26 1/2"
OSB339324	24"	27"	31 1/2"	22 1/2"	31 1/2"	26 1/2"
OSB279624	27"	21"	25 1/2"	22 1/2"	31 1/2"	29 1/2"
OSB309624	27"	24"	28 1/2"	22 1/2"	31 1/2"	29 1/2"
OSB31.59624	27"	25 1/2"	30"	22 1/2"	31 1/2"	29 1/2"
OSB339624	27"	27"	31 1/2"	22 1/2"	31 1/2"	29 1/2"

	A Frame Opening Height	B Cut-out Width (standard)		B Cut-out Width (with ACS modification)			C Cut-out Height		Door Height (Upper Section)
		Min.	Max.	Min.	Max.	Max. w/ Field Cut	Min.	Max.	Full Overlay
OSB279324N	24"	24"	25 1/2"	21"	24"	25 1/2"	22 1/2"	31 1/2"	26 1/2"
OSB309324N	24"	27"	28 1/2"	24"	27"	28 1/2"	22 1/2"	31 1/2"	26 1/2"
OSB31.59324N	24"	28 1/2"	30"	25 1/2"	28 1/2"	30"	22 1/2"	31 1/2"	26 1/2"
OSB339324N	24"	30"	31 1/2"	27"	30"	31 1/2"	22 1/2"	31 1/2"	26 1/2"
OSB279624N	27"	24"	25 1/2"	21"	24"	25 1/2"	22 1/2"	31 1/2"	29 1/2"
OSB309624N	27"	27"	28 1/2"	24"	27"	28 1/2"	22 1/2"	31 1/2"	29 1/2"
OSB31.59624N	27"	28 1/2"	30"	25 1/2"	28 1/2"	30"	22 1/2"	31 1/2"	29 1/2"
OSB339624N	27"	30"	31 1/2"	27"	30"	31 1/2"	22 1/2"	31 1/2"	29 1/2"

**Custom Modifications**

ACS	ADDTK	AUTH	CBO	CCO	CFNTO	CFRMO	CND	DRT	DRWTK	EXBK	EX	FB	FFD	FPEB	FTK	FTK_V	ID	INVRM	MMP	RD	RECTK	RT	TD	TKP	VTK	WLI
•*	•	•	•	•	•	•	•	•	•	•	•	•	•	•	•	•	•	•	•	•	•	•	•	•	•	•

\*Only available on Narrow Stile (N) cabinets

**Construction Upgrades**

APC	ET	PE
•	•	•

**Door Options**

CG.TOP	DPSRR	MFO
•†	•	•

†Only available on Narrow Stile (N) cabinets

**OVEN MICROWAVE COMBO  
CABINET, 84", 87", or 90" TALL,  
24" DEEP**

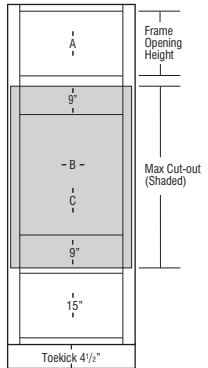
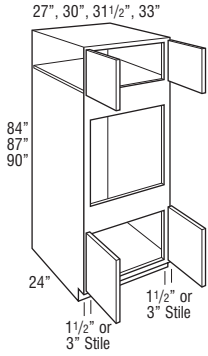

OCS\_24

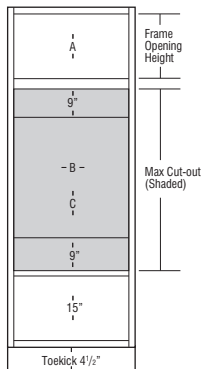

OCS\_24N

- OCS278424(N)
- OCS308424(N)
- OCS31.58424(N)
- OCS338424(N)
- OCS278724(N)
- OCS308724(N)
- OCS31.58724(N)
- OCS338724(N)
- OCS279024(N)
- OCS309024(N)
- OCS31.59024(N)
- OCS339024(N)

- N represents Narrow Stile cabinets with 1 1/2" wide face frame side stiles and ACS modification availability (see page 48 for ACS specifications). Doors have a consistent 1/4" width reveal and use standard smart close hinges.
- On cabinets with 3" wide face frame side stiles, doors use face mount hinges and have a consistent 1/4" width reveal.
- Upper section on 90" tall has one full depth adjustable shelf.
- All top and bottom cross rails are 1 1/2" wide.
- Be sure to confirm a heat shield is built into your appliance by the manufacturer or install the heat shield included with your appliance. Heat shields are sold separately as an accessory.
- Depth can be reduced to a minimum of 6". For depths of 6"-8", cabinet will not include toe kick/pedestal.
- For built-in appliance support, OCINSTALLKIT is included in 24" deep oven cabinets (see page 373 for details). Oven install kit will not be included when depth is modified.
- OCINSTALLKIT weight limit is 400 lbs. per pair.
- Oven cabinets feature an open back in cut-out area designed to improve field appliance installation.
- Maximum cut-out dimension will allow 1/4" reveal for doors for trim kit face clearance.

	A Frame Opening Height	B Cut-out Width		C Cut-out Height		Door Height (Upper Section)
		Min.	Max.	Min.	Max.	Full Overlay
OCS278424	15"	21"	25 1/2"	28 1/2"	43 1/2"	17 1/2"
OCS308424	15"	24"	28 1/2"	28 1/2"	43 1/2"	17 1/2"
OCS31.58424	15"	25 1/2"	30"	28 1/2"	43 1/2"	17 1/2"
OCS338424	15"	27"	31 1/2"	28 1/2"	43 1/2"	17 1/2"
OCS278724	18"	21"	25 1/2"	28 1/2"	43 1/2"	20 1/2"
OCS308724	18"	24"	28 1/2"	28 1/2"	43 1/2"	20 1/2"
OCS31.58724	18"	25 1/2"	30"	28 1/2"	43 1/2"	20 1/2"
OCS338724	18"	27"	31 1/2"	28 1/2"	43 1/2"	20 1/2"
OCS279024	21"	21"	25 1/2"	28 1/2"	43 1/2"	23 1/2"
OCS309024	21"	24"	28 1/2"	28 1/2"	43 1/2"	23 1/2"
OCS31.59024	21"	25 1/2"	30"	28 1/2"	43 1/2"	23 1/2"
OCS339024	21"	27"	31 1/2"	28 1/2"	43 1/2"	23 1/2"

	A Frame Opening Height	B Cut-out Width (standard)		B Cut-out Width (with ACS modification)			C Cut-out Height		Door Height (Upper Section)
		Min.	Max.	Min.	Max.	Max. w/ Field Cut	Min.	Max.	Full Overlay
OCS278424N	15"	24"	25 1/2"	21"	24"	25 1/2"	28 1/2"	43 1/2"	17 1/2"
OCS308424N	15"	27"	28 1/2"	24"	27"	28 1/2"	28 1/2"	43 1/2"	17 1/2"
OCS31.58424N	15"	28 1/2"	30"	25 1/2"	28 1/2"	30"	28 1/2"	43 1/2"	17 1/2"
OCS338424N	15"	30"	31 1/2"	27"	30"	31 1/2"	28 1/2"	43 1/2"	17 1/2"
OCS278724N	18"	24"	25 1/2"	21"	24"	25 1/2"	28 1/2"	43 1/2"	20 1/2"
OCS308724N	18"	27"	28 1/2"	24"	27"	28 1/2"	28 1/2"	43 1/2"	20 1/2"
OCS31.58724N	18"	28 1/2"	30"	25 1/2"	28 1/2"	30"	28 1/2"	43 1/2"	20 1/2"
OCS338724N	18"	30"	31 1/2"	27"	30"	31 1/2"	28 1/2"	43 1/2"	20 1/2"
OCS279024N	21"	24"	25 1/2"	21"	24"	25 1/2"	28 1/2"	43 1/2"	23 1/2"
OCS309024N	21"	27"	28 1/2"	24"	27"	28 1/2"	28 1/2"	43 1/2"	23 1/2"
OCS31.59024N	21"	28 1/2"	30"	25 1/2"	28 1/2"	30"	28 1/2"	43 1/2"	23 1/2"
OCS339024N	21"	30"	31 1/2"	27"	30"	31 1/2"	28 1/2"	43 1/2"	23 1/2"

**Custom Modifications**

ACS	ADDTK	AUTH	CBO	CCO	CFNTO	CFRMO	CND	DRT	DRWTK	EXBK	EX	FB	FDD	FPFB	FTK	FTK_V	ID	INVRM	MIP	RD	RECTK	RT	TD	TKP	VTK	WLI
•*			•	•*	•	•	•			•	•	•	•	•	•	•	•	•	•	•	•	•	•	•	•	•

\*Only available on Narrow Stile (N) cabinets \*Not available on 84" and 87" tall

**Construction Upgrades**

APC	ET	PE
•		•

**Door Options**

CG.TOP	DPSRR	MFO
	•	•

**OVEN MICROWAVE COMBO  
CABINET, 93" or 96" TALL,  
24" DEEP**

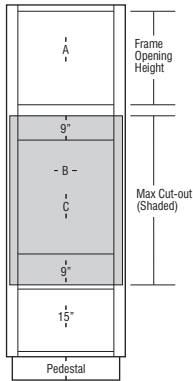
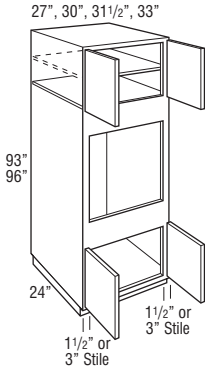

OCS\_24

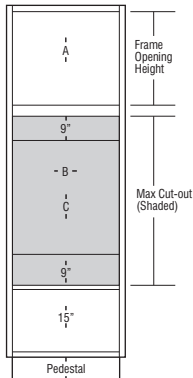

OCS\_24N

- OCS279324(N)
- OCS309324(N)
- OCS31.59324(N)
- OCS339324(N)
- OCS279624(N)
- OCS309624(N)
- OCS31.59624(N)
- OCS339624(N)

- N represents Narrow Stile cabinets with 1 1/2" wide face frame side stiles and ACS modification availability (see page 48 for ACS specifications). Doors have a consistent 1/4" width reveal and use standard smart close hinges.
- On cabinets with 3" wide face frame side stiles, doors use face mount hinges and have a consistent 1/4" width reveal.
- Includes adjustable shelves in upper section:  
93" tall - one shelf  
96" tall - two shelves
- All top and bottom cross rails are 1 1/2" wide.
- Be sure to confirm a heat shield is built into your appliance by the manufacturer or install the heat shield included with your appliance. Heat shields are sold separately as an accessory.
- Separate pedestal base included but packaged separately on 93" and 96" tall. Pedestal is designed to create a Recessed Left or Right Toekick application during field installation, or can be centered. Pedestal must be covered with toeboard material.
- Depth can be reduced to a minimum of 6". For depths of 6"-8", cabinet will not include toekick/pedestal.
- For built-in appliance support, OCINSTALLKIT is included in 24" deep oven cabinets (see page 373 for details). Oven install kit will not be included when depth is modified.
- OCINSTALLKIT weight limit is 400 lbs. per pair.
- Oven cabinets feature an open back in cut-out area designed to improve field appliance installation.
- Maximum cut-out dimension will allow 1/4" reveal for doors for trim kit face clearance.

	A Frame Opening Height	B Cut-out Width		C Cut-out Height		Door Height (Upper Section) Full Overlay
		Min.	Max.	Min.	Max.	
OCS279324	24"	21"	25 1/2"	28 1/2"	43 1/2"	26 1/2"
OCS309324	24"	24"	28 1/2"	28 1/2"	43 1/2"	26 1/2"
OCS31.59324	24"	25 1/2"	30"	28 1/2"	43 1/2"	26 1/2"
OCS339324	24"	27"	31 1/2"	28 1/2"	43 1/2"	26 1/2"
OCS279624	27"	21"	25 1/2"	28 1/2"	43 1/2"	29 1/2"
OCS309624	27"	24"	28 1/2"	28 1/2"	43 1/2"	29 1/2"
OCS31.59624	27"	25 1/2"	30"	28 1/2"	43 1/2"	29 1/2"
OCS339624	27"	27"	31 1/2"	28 1/2"	43 1/2"	29 1/2"

	A Frame Opening Height	B Cut-out Width (standard)		B Cut-out Width (with ACS modification)			C Cut-out Height		Door Height (Upper Section) Full Overlay
		Min.	Max.	Min.	Max.	Max. w/ Field Cut	Min.	Max.	
OCS279324N	24"	24"	25 1/2"	21"	24"	25 1/2"	28 1/2"	43 1/2"	26 1/2"
OCS309324N	24"	27"	28 1/2"	24"	27"	28 1/2"	28 1/2"	43 1/2"	26 1/2"
OCS31.59324N	24"	28 1/2"	30"	25 1/2"	28 1/2"	30"	28 1/2"	43 1/2"	26 1/2"
OCS339324N	24"	30"	31 1/2"	27"	30"	31 1/2"	28 1/2"	43 1/2"	26 1/2"
OCS279624N	27"	24"	25 1/2"	21"	24"	25 1/2"	28 1/2"	43 1/2"	29 1/2"
OCS309624N	27"	27"	28 1/2"	24"	27"	28 1/2"	28 1/2"	43 1/2"	29 1/2"
OCS31.59624N	27"	28 1/2"	30"	25 1/2"	28 1/2"	30"	28 1/2"	43 1/2"	29 1/2"
OCS339624N	27"	30"	31 1/2"	27"	30"	31 1/2"	28 1/2"	43 1/2"	29 1/2"

**Custom Modifications**

ACS	ADTK	AUTH	CBO	CCO	CFNTD	CFRMO	CND	DRT	DRWTK	EXBK	EX	FB	FFD	FPEB	FTK	FTK_V	ID	INVFRM	MPP	RD	RECTK	RT	TD	TKP	VTK	WLI
•*	•	•	•	•	•	•	•	•	•	•	•	•	•	•	•	•	•	•	•	•	•	•	•	•	•	•

\*Only available on Narrow Stile (N) cabinets

**Construction Upgrades**

APC	ET	PE
•	•	•

**Door Options**

CG.TOP	DPSRR	MFO
•	•	•

**OVEN MICROWAVE COMBO  
CABINET, DEEP DRAWER,  
84", 87", or 90" TALL, 24" DEEP**

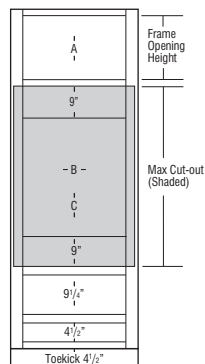
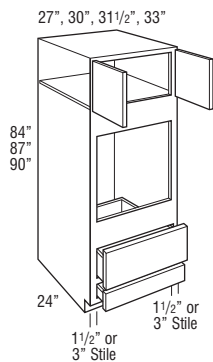

OCS\_24DD

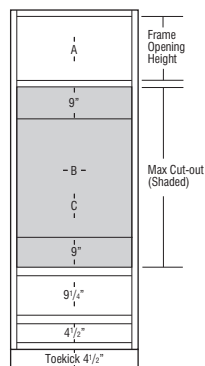

OCS\_24DDN

- OCS278424DD(N)
- OCS308424DD(N)
- OCS31.58424DD(N)
- OCS338424DD(N)
- OCS278724DD(N)
- OCS308724DD(N)
- OCS31.58724DD(N)
- OCS338724DD(N)
- OCS279024DD(N)
- OCS309024DD(N)
- OCS31.59024DD(N)
- OCS339024DD(N)

- N represents Narrow Stile cabinets with 1 1/2" wide face frame side stiles and ACS modification availability (see page 48 for ACS specifications). Doors and drawer fronts have a consistent 1/4" width reveal and use standard smart close hinges.
- On cabinets with 3" wide face frame side stiles, doors use face mount hinges. Doors and drawer fronts have a consistent 1/4" width reveal.
- Cabinets with 3" wide face frames are not available in Door 37 Decorative Laminate, or Door 15, Door 18, and Door 32 MDF door styles.
- Upper section on 90" tall has one full depth adjustable shelf.
- All top and bottom cross rails are 1 1/2" wide.
- Be sure to confirm a heat shield is built into your appliance by the manufacturer or install the heat shield included with your appliance. Heat shields are sold separately as an accessory.
- Depth can be reduced to a minimum of 12".
- For built-in appliance support, OCINSTALLKIT is included in 24" deep oven cabinets (see page 373 for details). Oven install kit will not be included when depth is modified.
- OCINSTALLKIT weight limit is 400 lbs. per pair.
- Oven cabinets feature an open back in cut-out area designed to improve field appliance installation.
- Maximum cut-out dimension will allow 1/4" reveal for doors and drawer fronts for trim kit face clearance.

	A Frame Opening Height	B Cut-out Width		C Cut-out Height		Door Height (Upper Section)
		Min.	Max.	Min.	Max.	Full Overlay
OCS278424DD	15"	21"	25 1/2"	27 3/4"	42 3/4"	17 1/2"
OCS308424DD	15"	24"	28 1/2"	27 3/4"	42 3/4"	17 1/2"
OCS31.58424DD	15"	25 1/2"	30"	27 3/4"	42 3/4"	17 1/2"
OCS338424DD	15"	27"	31 1/2"	27 3/4"	42 3/4"	17 1/2"
OCS278724DD	18"	21"	25 1/2"	27 3/4"	42 3/4"	20 1/2"
OCS308724DD	18"	24"	28 1/2"	27 3/4"	42 3/4"	20 1/2"
OCS31.58724DD	18"	25 1/2"	30"	27 3/4"	42 3/4"	20 1/2"
OCS338724DD	18"	27"	31 1/2"	27 3/4"	42 3/4"	20 1/2"
OCS279024DD	21"	21"	25 1/2"	27 3/4"	42 3/4"	23 1/2"
OCS309024DD	21"	24"	28 1/2"	27 3/4"	42 3/4"	23 1/2"
OCS31.59024DD	21"	25 1/2"	30"	27 3/4"	42 3/4"	23 1/2"
OCS339024DD	21"	27"	31 1/2"	27 3/4"	42 3/4"	23 1/2"

	A Frame Opening Height	B Cut-out Width (standard)		B Cut-out Width (with ACS modification)			C Cut-out Height		Door Height (Upper Section)
		Min.	Max.	Min.	Max.	Max. w/ Field Cut	Min.	Max.	Full Overlay
OCS278424DDN	15"	24"	25 1/2"	21"	24"	25 1/2"	27 3/4"	42 3/4"	17 1/2"
OCS308424DDN	15"	27"	28 1/2"	24"	27"	28 1/2"	27 3/4"	42 3/4"	17 1/2"
OCS31.58424DDN	15"	28 1/2"	30"	25 1/2"	28 1/2"	30"	27 3/4"	42 3/4"	17 1/2"
OCS338424DDN	15"	30"	31 1/2"	27"	30"	31 1/2"	27 3/4"	42 3/4"	17 1/2"
OCS278724DDN	18"	24"	25 1/2"	21"	24"	25 1/2"	27 3/4"	42 3/4"	20 1/2"
OCS308724DDN	18"	27"	28 1/2"	24"	27"	28 1/2"	27 3/4"	42 3/4"	20 1/2"
OCS31.58724DDN	18"	28 1/2"	30"	25 1/2"	28 1/2"	30"	27 3/4"	42 3/4"	20 1/2"
OCS338724DDN	18"	30"	31 1/2"	27"	30"	31 1/2"	27 3/4"	42 3/4"	20 1/2"
OCS279024DDN	21"	24"	25 1/2"	21"	24"	25 1/2"	27 3/4"	42 3/4"	23 1/2"
OCS309024DDN	21"	27"	28 1/2"	24"	27"	28 1/2"	27 3/4"	42 3/4"	23 1/2"
OCS31.59024DDN	21"	28 1/2"	30"	25 1/2"	28 1/2"	30"	27 3/4"	42 3/4"	23 1/2"
OCS339024DDN	21"	30"	31 1/2"	27"	30"	31 1/2"	27 3/4"	42 3/4"	23 1/2"

**Custom Modifications**

ACS	ADDTK	AUTH	CBO	CCO	CFNTO	CFRMO	CND	DRT	DRWTK	EXBK	EX	FB	FFD	FPFB	FTK	FTK_V	ID	INVFRM	MIP	RD	RECTK_	RT	TD	TKP	VTK	WLI
•*																										

\*Only available on Narrow Stile (N) cabinets

**Construction Upgrades**

APC	ET	PE
•		•

**Door Options**

CG.TOP	DPSRR	MFO
	•	•



**OVEN MICROWAVE COMBO  
CABINET, DEEP DRAWER,  
93" or 96" TALL, 24" DEEP**

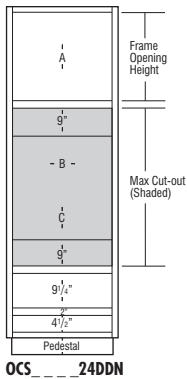
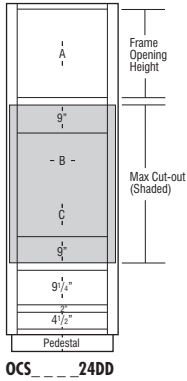
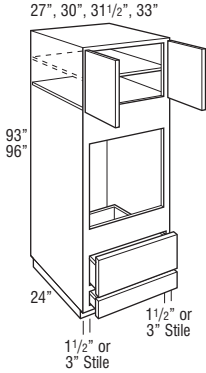

- OCS279324DD(N)**
- OCS309324DD(N)**
- OCS31.59324DD(N)**
- OCS339324DD(N)**
- OCS279624DD(N)**
- OCS309624DD(N)**
- OCS31.59624DD(N)**
- OCS339624DD(N)**

- N represents Narrow Stile cabinets with 1 1/2" wide face frame side stiles and ACS modification availability (see page 48 for ACS specifications). Doors and drawer fronts have a consistent 1/4" width reveal and use standard smart close hinges.
- On cabinets with 3" wide face frame side stiles, doors use face mount hinges. Doors and drawer fronts have a consistent 1/4" width reveal.
- Cabinets with 3" wide face frames are not available in Door 37 Decorative Laminate, or Door 15, Door 18, and Door 32 MDF door styles.
- Includes adjustable shelves in upper section:
  - 93" tall - one shelf
  - 96" tall - two shelves
- All top and bottom cross rails are 1 1/2" wide.
- Be sure to confirm a heat shield is built into your appliance by the manufacturer or install the heat shield included with your appliance. Heat shields are sold separately as an accessory.
- Separate pedestal base included but packaged separately on 93" and 96" tall. Pedestal is designed to create a Recessed Left or Right Toekick application during field installation, or can be centered. Pedestal must be covered with toeboard material.
- Depth can be reduced to a minimum of 12".
- For built-in appliance support, OCINSTALLKIT is included in 24" deep oven cabinets (see page 373 for details). Oven install kit will not be included when depth is modified.
- OCINSTALLKIT weight limit is 400 lbs. per pair.
- Oven cabinets feature an open back in cut-out area designed to improve field appliance installation.
- Maximum cut-out dimension will allow 1/4" reveal for doors and drawer fronts for trim kit face clearance.

	A Frame Opening Height	B Cut-out Width		C Cut-out Height		Door Height (Upper Section)
		Min.	Max.	Min.	Max.	Full Overlay
OCS279324DD	24"	21"	25 1/2"	27 3/4"	42 3/4"	26 1/2"
OCS309324DD	24"	24"	28 1/2"	27 3/4"	42 3/4"	26 1/2"
OCS31.59324DD	24"	25 1/2"	30"	27 3/4"	42 3/4"	26 1/2"
OCS339324DD	24"	27"	31 1/2"	27 3/4"	42 3/4"	26 1/2"
OCS279624DD	27"	21"	25 1/2"	27 3/4"	42 3/4"	29 1/2"
OCS309624DD	27"	24"	28 1/2"	27 3/4"	42 3/4"	29 1/2"
OCS31.59624DD	27"	25 1/2"	30"	27 3/4"	42 3/4"	29 1/2"
OCS339624DD	27"	27"	31 1/2"	27 3/4"	42 3/4"	29 1/2"

	A Frame Opening Height	B Cut-out Width (standard)		B Cut-out Width (with ACS modification)			C Cut-out Height		Door Height (Upper Section)
		Min.	Max.	Min.	Max.	Max. w/ Field Cut	Min.	Max.	Full Overlay
OCS279324DDN	24"	24"	25 1/2"	21"	24"	25 1/2"	27 3/4"	42 3/4"	26 1/2"
OCS309324DDN	24"	27"	28 1/2"	24"	27"	28 1/2"	27 3/4"	42 3/4"	26 1/2"
OCS31.59324DDN	24"	28 1/2"	30"	25 1/2"	28 1/2"	30"	27 3/4"	42 3/4"	26 1/2"
OCS339324DDN	24"	30"	31 1/2"	27"	30"	31 1/2"	27 3/4"	42 3/4"	26 1/2"
OCS279624DDN	27"	24"	25 1/2"	21"	24"	25 1/2"	27 3/4"	42 3/4"	29 1/2"
OCS309624DDN	27"	27"	28 1/2"	24"	27"	28 1/2"	27 3/4"	42 3/4"	29 1/2"
OCS31.59624DDN	27"	28 1/2"	30"	25 1/2"	28 1/2"	30"	27 3/4"	42 3/4"	29 1/2"
OCS339624DDN	27"	30"	31 1/2"	27"	30"	31 1/2"	27 3/4"	42 3/4"	29 1/2"

**Custom Modifications**

ACS	ADDTK	AUTH	CBO	CCO	CFNTD	CFRMO	CND	DRT	DRWTK	EXBK	EX	FB	FFD	FPEB	FTK	FTK_V	ID	INVRM	MIP	RD	RECTK	RT	TD	TKP	VTK	WLI
•*	•	•	•	•	•	•	•	•	•	•	•	•	•	•	•	•	•	•	•	•	•	•	•	•	•	•

\*Only available on Narrow Stile (N) cabinets

**Construction Upgrades**

APC	ET	PE
•	•	•

**Door Options**

CG.TOP	DPSRR	MFO
•	•	•

**OVEN MICROWAVE COMBO  
CABINET, WARMING DRAWER,  
84", 87", 90", 93", or 96" TALL,  
24" DEEP**

244

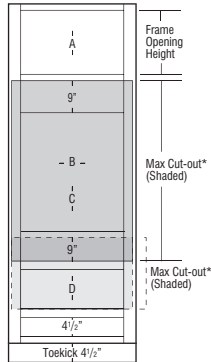
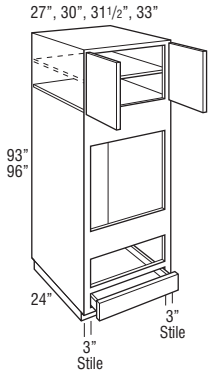
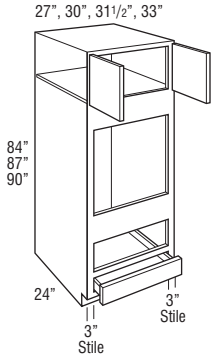

\*Minimum rail height between oven and warming drawer is 1 1/2"

- OCS278424WD
- OCS308424WD
- OCS31.58424WD
- OCS338424WD
- OCS278724WD
- OCS308724WD
- OCS31.58724WD
- OCS338724WD
- OCS279024WD
- OCS309024WD
- OCS31.59024WD
- OCS339024WD

- OCS279324WD
- OCS309324WD
- OCS31.59324WD
- OCS339324WD
- OCS279624WD
- OCS309624WD
- OCS31.59624WD
- OCS339624WD

- Includes adjustable shelves in upper section:  
90" and 93" tall - one shelf  
96" tall - two shelves
- Uses face mount hinges, doors and drawer fronts have a consistent 1/4" width reveal.
- Cabinets with 3" wide face frames are not available in Door 37 Decorative Laminate, or Door 15, Door 18, and Door 32 MDF door styles.
- All top and bottom cross rails are 1 1/2" wide.
- Be sure to confirm a heat shield is built into your appliance by the manufacturer or install the heat shield included with your appliance. Heat shields are sold separately as an accessory.
- Separate pedestal base included but packaged separately on 93" and 96" tall. Pedestal is designed to create a Recessed Left or Right Toekick application during field installation, or can be centered. Pedestal must be covered with toeboard material.
- Depth can be reduced to a minimum of 12".
- For built-in appliance support, OCINSTALKIT is included in 24" deep oven cabinets (see page 373 for details). Oven install kit will not be included when depth is modified.
- OCINSTALKIT weight limit is 400 lbs. per pair.
- Oven cabinets feature an open back in cut-out area designed to improve field appliance installation.
- Maximum cut-out dimension will allow 1/4" reveal for doors and drawer fronts for trim kit face clearance.

	A Frame Opening Height	B Cut-out Width		C Cut-out Height		D Warming Drawer Cut-out Height		Door Height (Upper Section)
		Min.	Max.	Min.	Max.	Min.	Max.	Full Overlay
OCS278424WD	15"	21"	25 1/2"	27 3/4"	42 3/4"	9 1/4"	16 3/4"	17 1/2"
OCS308424WD	15"	24"	28 1/2"	27 3/4"	42 3/4"	9 1/4"	16 3/4"	17 1/2"
OCS31.58424WD	15"	25 1/2"	30"	27 3/4"	42 3/4"	9 1/4"	16 3/4"	17 1/2"
OCS338424WD	15"	27"	31 1/2"	27 3/4"	42 3/4"	9 1/4"	16 3/4"	17 1/2"
OCS278724WD	18"	21"	25 1/2"	27 3/4"	42 3/4"	9 1/4"	16 3/4"	20 1/2"
OCS308724WD	18"	24"	28 1/2"	27 3/4"	42 3/4"	9 1/4"	16 3/4"	20 1/2"
OCS31.58724WD	18"	25 1/2"	30"	27 3/4"	42 3/4"	9 1/4"	16 3/4"	20 1/2"
OCS338724WD	18"	27"	31 1/2"	27 3/4"	42 3/4"	9 1/4"	16 3/4"	20 1/2"
OCS279024WD	21"	21"	25 1/2"	27 3/4"	42 3/4"	9 1/4"	16 3/4"	23 1/2"
OCS309024WD	21"	24"	28 1/2"	27 3/4"	42 3/4"	9 1/4"	16 3/4"	23 1/2"
OCS31.59024WD	21"	25 1/2"	30"	27 3/4"	42 3/4"	9 1/4"	16 3/4"	23 1/2"
OCS339024WD	21"	27"	31 1/2"	27 3/4"	42 3/4"	9 1/4"	16 3/4"	23 1/2"
OCS279324WD	24"	21"	25 1/2"	27 3/4"	42 3/4"	9 1/4"	16 3/4"	26 1/2"
OCS309324WD	24"	24"	28 1/2"	27 3/4"	42 3/4"	9 1/4"	16 3/4"	26 1/2"
OCS31.59324WD	24"	25 1/2"	30"	27 3/4"	42 3/4"	9 1/4"	16 3/4"	26 1/2"
OCS339324WD	24"	27"	31 1/2"	27 3/4"	42 3/4"	9 1/4"	16 3/4"	26 1/2"
OCS279624WD	27"	21"	25 1/2"	27 3/4"	42 3/4"	9 1/4"	16 3/4"	29 1/2"
OCS309624WD	27"	24"	28 1/2"	27 3/4"	42 3/4"	9 1/4"	16 3/4"	29 1/2"
OCS31.59624WD	27"	25 1/2"	30"	27 3/4"	42 3/4"	9 1/4"	16 3/4"	29 1/2"
OCS339624WD	27"	27"	31 1/2"	27 3/4"	42 3/4"	9 1/4"	16 3/4"	29 1/2"

**Custom Modifications**

ACS	ADDTK	AUTH	CBO	CCO	CFNTO	CFRMO	CND	DRT	DRWTK	EXBK	EX	FB	FFD	FPEB	FTK	FTK_V	ID	INVRM	MIP	RD	RECTK	RT	TD	TKP	VTK	WLI	
									*																*	*	

\*Not available on 93" and 96" tall

**Construction Upgrades**

APC	ET	PE

**Door Options**

CG.TOP	DPSRR	MFO

**DOUBLE OVEN CABINET,  
84", 87", or 90" TALL, 24" DEEP**

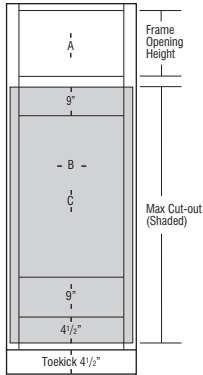
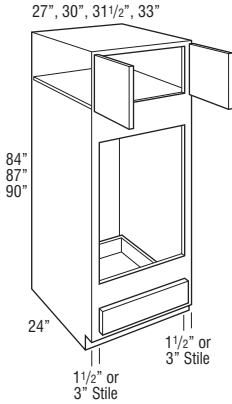

OCD \_\_\_ 24

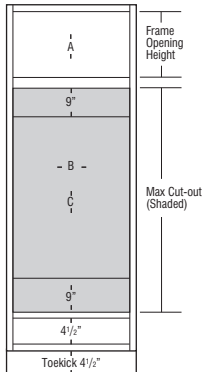

OCD \_\_\_ 24N

- OCD278424(N)
- OCD308424(N)
- OCD31.58424(N)
- OCD338424(N)
- OCD278724(N)
- OCD308724(N)
- OCD31.58724(N)
- OCD338724(N)
- OCD279024(N)
- OCD309024(N)
- OCD31.59024(N)
- OCD339024(N)

- N represents Narrow Stile cabinets with 1 1/2" wide face frame side stiles and ACS modification availability (see page 48 for ACS specifications). Doors and drawer fronts have a consistent 1/4" width reveal and use standard smart close hinges.
- On cabinets with 3" wide face frame side stiles, doors use face mount hinges. Doors and drawer fronts have a consistent 1/4" width reveal.
- Cabinets with 3" wide face frames are not available in Door 37 Decorative Laminate, or Door 15, Door 18, and Door 32 MDF door styles.
- Upper section on 90" tall has one full depth adjustable shelf.
- All top and bottom cross rails are 1 1/2" wide.
- Be sure to confirm a heat shield is built into your appliance by the manufacturer or install the heat shield included with your appliance. Heat shields are sold separately as an accessory.
- Depth can be reduced to a minimum of 12".
- For built-in appliance support, OCINSTALLKIT is included in 24" deep oven cabinets (see page 373 for details). Oven install kit will not be included when depth is modified.
- OCINSTALLKIT weight limit is 400 lbs. per pair.
- Oven cabinets feature an open back in cut-out area designed to improve field appliance installation.
- Maximum cut-out dimension will allow 1/4" reveal for doors and drawer fronts for trim kit face clearance.

	A Frame Opening Height	B Cut-out Width		C Cut-out Height		Door Height (Upper Section)
		Min.	Max.	Min.	Max.	Full Overlay
OCD278424	15"	21"	25 1/2"	39"	60"	17 1/2"
OCD308424	15"	24"	28 1/2"	39"	60"	17 1/2"
OCD31.58424	15"	25 1/2"	30"	39"	60"	17 1/2"
OCD338424	15"	27"	31 1/2"	39"	60"	17 1/2"
OCD278724	18"	21"	25 1/2"	39"	60"	20 1/2"
OCD308724	18"	24"	28 1/2"	39"	60"	20 1/2"
OCD31.58724	18"	25 1/2"	30"	39"	60"	20 1/2"
OCD338724	18"	27"	31 1/2"	39"	60"	20 1/2"
OCD279024	21"	21"	25 1/2"	39"	60"	23 1/2"
OCD309024	21"	24"	28 1/2"	39"	60"	23 1/2"
OCD31.59024	21"	25 1/2"	30"	39"	60"	23 1/2"
OCD339024	21"	27"	31 1/2"	39"	60"	23 1/2"

	A Frame Opening Height	B Cut-out Width (standard)		B Cut-out Width (with ACS modification)			C Cut-out Height		Door Height (Upper Section)
		Min.	Max.	Min.	Max.	Max. w/ Field Cut	Min.	Max.	Full Overlay
OCD278424N	15"	24"	25 1/2"	21"	24"	25 1/2"	39"	54"	17 1/2"
OCD308424N	15"	27"	28 1/2"	24"	27"	28 1/2"	39"	54"	17 1/2"
OCD31.58424N	15"	28 1/2"	30"	25 1/2"	28 1/2"	30"	39"	54"	17 1/2"
OCD338424N	15"	30"	31 1/2"	27"	30"	31 1/2"	39"	54"	17 1/2"
OCD278724N	18"	24"	25 1/2"	21"	24"	25 1/2"	39"	54"	20 1/2"
OCD308724N	18"	27"	28 1/2"	24"	27"	28 1/2"	39"	54"	20 1/2"
OCD31.58724N	18"	28 1/2"	30"	25 1/2"	28 1/2"	30"	39"	54"	20 1/2"
OCD338724N	18"	30"	31 1/2"	27"	30"	31 1/2"	39"	54"	20 1/2"
OCD279024N	21"	24"	25 1/2"	21"	24"	25 1/2"	39"	54"	23 1/2"
OCD309024N	21"	27"	28 1/2"	24"	27"	28 1/2"	39"	54"	23 1/2"
OCD31.59024N	21"	28 1/2"	30"	25 1/2"	28 1/2"	30"	39"	54"	23 1/2"
OCD339024N	21"	30"	31 1/2"	27"	30"	31 1/2"	39"	54"	23 1/2"

**Custom Modifications**

ACS	ADDTK	AUTH	CBO	CCO	CFNTO	CFRMO	CND	DRT	DRWTK	EXBK	EX	FB	FFD	FPEB	FTK	FTK_V	ID	INVRM	MIP	RD	RECTK	RT	TD	TKP	VTK	WLI
•*	•	•	•	•	•	•	•	•	•	•	•	•	•	•	•	•	•	•	•	•	•	•	•	•	•	•

\*Only available on Narrow Stile (N) cabinets

**Construction Upgrades**

APC	ET	PE
•	•	•

**Door Options**

CG.TOP	DPSRR	MFO
•	•	•

**DOUBLE OVEN CABINET,  
93" or 96" TALL, 24" DEEP**

27", 30", 31 1/2", 33"

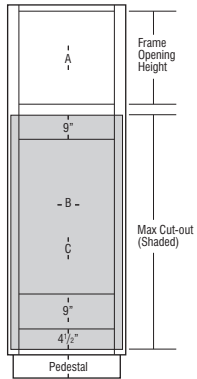
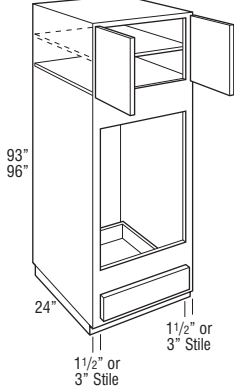

OCD \_ \_ 24

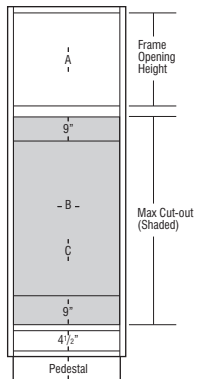

OCD \_ \_ 24N

**OCD279324(N)**

**OCD309324(N)**

**OCD31.59324(N)**

**OCD339324(N)**

**OCD279624(N)**

**OCD309624(N)**

**OCD31.59624(N)**

**OCD339624(N)**

- N represents Narrow Stile cabinets with 1 1/2" wide face frame side stiles and ACS modification availability (see page 48 for ACS specifications). Doors and drawer fronts have a consistent 1/4" width reveal and use standard smart close hinges.
- On cabinets with 3" wide face frame side stiles, doors use face mount hinges. Doors and drawer fronts have a consistent 1/4" width reveal.
- Cabinets with 3" wide face frames are not available in Door 37 Decorative Laminate, or Door 15, Door 18, and Door 32 MDF door styles.
- Includes adjustable shelves in upper section:  
93" tall - one shelf  
96" tall - two shelves
- All top and bottom cross rails are 1 1/2" wide.
- Be sure to confirm a heat shield is built into your appliance by the manufacturer or install the heat shield included with your appliance. Heat shields are sold separately as an accessory.
- Separate pedestal base included but packaged separately on 93" and 96" tall. Pedestal is designed to create a Recessed Left or Right Toekick application during field installation, or can be centered. Pedestal must be covered with toeboard material.
- Depth can be reduced to a minimum of 12".
- For built-in appliance support, OCINSTALLKIT is included in 24" deep oven cabinets (see page 373 for details). Oven install kit will not be included when depth is modified.
- OCINSTALLKIT weight limit is 400 lbs. per pair.
- Oven cabinets feature an open back in cut-out area designed to improve field appliance installation.
- Maximum cut-out dimension will allow 1/4" reveal for doors and drawer fronts for trim kit face clearance.

	A Frame Opening Height	B Cut-out Width		C Cut-out Height		Door Height (Upper Section)
		Min.	Max.	Min.	Max.	Full Overlay
OCD279324	24"	21"	25 1/2"	39"	60"	26 1/2"
OCD309324	24"	24"	28 1/2"	39"	60"	26 1/2"
OCD31.59324	24"	25 1/2"	30"	39"	60"	26 1/2"
OCD339324	24"	27"	31 1/2"	39"	60"	26 1/2"
OCD279624	27"	21"	25 1/2"	39"	60"	29 1/2"
OCD309624	27"	24"	28 1/2"	39"	60"	29 1/2"
OCD31.59624	27"	25 1/2"	30"	39"	60"	29 1/2"
OCD339624	27"	27"	31 1/2"	39"	60"	29 1/2"

	A Frame Opening Height	B Cut-out Width (standard)		B Cut-out Width (with ACS modification)			C Cut-out Height		Door Height (Upper Section)
		Min.	Max.	Min.	Max.	Max. w/ Field Cut	Min.	Max.	Full Overlay
OCD279324N	24"	24"	25 1/2"	21"	24"	25 1/2"	39"	54"	26 1/2"
OCD309324N	24"	27"	28 1/2"	24"	27"	28 1/2"	39"	54"	26 1/2"
OCD31.59324N	24"	28 1/2"	30"	25 1/2"	28 1/2"	30"	39"	54"	26 1/2"
OCD339324N	24"	30"	31 1/2"	27"	30"	31 1/2"	39"	54"	26 1/2"
OCD279624N	27"	24"	25 1/2"	21"	24"	25 1/2"	39"	54"	29 1/2"
OCD309624N	27"	27"	28 1/2"	24"	27"	28 1/2"	39"	54"	29 1/2"
OCD31.59624N	27"	28 1/2"	30"	25 1/2"	28 1/2"	30"	39"	54"	29 1/2"
OCD339624N	27"	30"	31 1/2"	27"	30"	31 1/2"	39"	54"	29 1/2"

**Custom Modifications**

ACS	ADDTK	AUTH	CBO	CCO	CFNTO	CFRMO	CND	DRT	DRWTK	EXBK	EX	FB	FFD	FPEB	FTK	FTK_V	ID	INVFRM	MIP	RD	RECTK	RT	TD	TKP	VTK	WLI
•*	•	•	•	•	•	•	•	•	•	•	•	•	•	•	•	•	•	•	•	•	•	•	•	•	•	•

\*Only available on Narrow Stile (N) cabinets

**Construction Upgrades**

APC	ET	PE
•	•	•

**Door Options**

CG.TOP	DPSRR	MFO
•	•	•

**DOUBLE OVEN CABINET,  
DEEP DRAWER,  
84", 87", or 90" TALL, 24" DEEP**

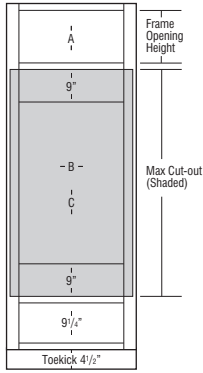
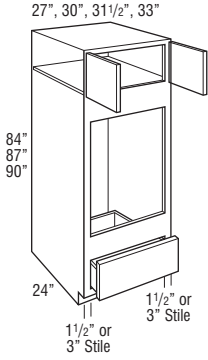

**OCD \_ \_ \_ 24DD**

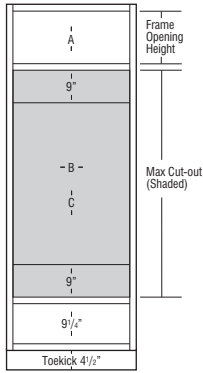

**OCD \_ \_ \_ 24DDN**

- OCD278424DD(N)**
- OCD308424DD(N)**
- OCD31.58424DD(N)**
- OCD338424DD(N)**
- OCD278724DD(N)**
- OCD308724DD(N)**
- OCD31.58724DD(N)**
- OCD338724DD(N)**
- OCD279024DD(N)**
- OCD309024DD(N)**
- OCD31.59024DD(N)**
- OCD339024DD(N)**

- N represents Narrow Stile cabinets with 1 1/2" wide face frame side stiles and ACS modification availability (see page 48 for ACS specifications). Doors and drawer fronts have a consistent 1/4" width reveal and use standard smart close hinges.
- On cabinets with 3" wide face frame side stiles, doors use face mount hinges. Doors and drawer fronts have a consistent 1/4" width reveal.
- All top and bottom cross rails are 1 1/2" wide.
- Be sure to confirm a heat shield is built into your appliance by the manufacturer or install the heat shield included with your appliance. Heat shields are sold separately as an accessory.
- Depth can be reduced to a minimum of 12".
- For built-in appliance support, OCINSTALLKIT is included in 24" deep oven cabinets (see page 373 for details). Oven install kit will not be included when depth is modified.
- OCINSTALLKIT weight limit is 400 lbs. per pair.
- Oven cabinets feature an open back in cut-out area designed to improve field appliance installation.
- Maximum cut-out dimension will allow 1/4" reveal for doors and drawer fronts for trim kit face clearance.

	A Frame Opening Height	B Cut-out Width		C Cut-out Height		Door Height (Upper Section) Full Overlay
		Min.	Max.	Min.	Max.	
OCD278424DD	12"	21"	25 1/2"	37 1/4"	52 1/4"	14 1/2"
OCD308424DD	12"	24"	28 1/2"	37 1/4"	52 1/4"	14 1/2"
OCD31.58424DD	12"	25 1/2"	30"	37 1/4"	52 1/4"	14 1/2"
OCD338424DD	12"	27"	31 1/2"	37 1/4"	52 1/4"	14 1/2"
OCD278724DD	15"	21"	25 1/2"	37 1/4"	52 1/4"	17 1/2"
OCD308724DD	15"	24"	28 1/2"	37 1/4"	52 1/4"	17 1/2"
OCD31.58724DD	15"	25 1/2"	30"	37 1/4"	52 1/4"	17 1/2"
OCD338724DD	15"	27"	31 1/2"	37 1/4"	52 1/4"	17 1/2"
OCD279024DD	18"	21"	25 1/2"	37 1/4"	52 1/4"	20 1/2"
OCD309024DD	18"	24"	28 1/2"	37 1/4"	52 1/4"	20 1/2"
OCD31.59024DD	18"	25 1/2"	30"	37 1/4"	52 1/4"	20 1/2"
OCD339024DD	18"	27"	31 1/2"	37 1/4"	52 1/4"	20 1/2"

	A Frame Opening Height	B Cut-out Width (standard)		B Cut-out Width (with ACS modification)			C Cut-out Height		Door Height (Upper Section) Full Overlay
		Min.	Max.	Min.	Max.	Max. w/ Field Cut	Min.	Max.	
OCD278424DDN	12"	24"	25 1/2"	21"	24"	25 1/2"	37 1/4"	52 1/4"	14 1/2"
OCD308424DDN	12"	27"	28 1/2"	24"	27"	28 1/2"	37 1/4"	52 1/4"	14 1/2"
OCD31.58424DDN	12"	28 1/2"	30"	25 1/2"	28 1/2"	30"	37 1/4"	52 1/4"	14 1/2"
OCD338424DDN	12"	30"	31 1/2"	27"	30"	31 1/2"	37 1/4"	52 1/4"	14 1/2"
OCD278724DDN	15"	24"	25 1/2"	21"	24"	25 1/2"	37 1/4"	52 1/4"	17 1/2"
OCD308724DDN	15"	27"	28 1/2"	24"	27"	28 1/2"	37 1/4"	52 1/4"	17 1/2"
OCD31.58724DDN	15"	28 1/2"	30"	25 1/2"	28 1/2"	30"	37 1/4"	52 1/4"	17 1/2"
OCD338724DDN	15"	30"	31 1/2"	27"	30"	31 1/2"	37 1/4"	52 1/4"	17 1/2"
OCD279024DDN	18"	24"	25 1/2"	21"	24"	25 1/2"	37 1/4"	52 1/4"	20 1/2"
OCD309024DDN	18"	27"	28 1/2"	24"	27"	28 1/2"	37 1/4"	52 1/4"	20 1/2"
OCD31.59024DDN	18"	28 1/2"	30"	25 1/2"	28 1/2"	30"	37 1/4"	52 1/4"	20 1/2"
OCD339024DDN	18"	30"	31 1/2"	27"	30"	31 1/2"	37 1/4"	52 1/4"	20 1/2"

**Custom Modifications**

ACS	ADDTK	AUTH	CBO	CCO	CFNTO	CFRMO	CND	DRT	DRWTK	EXBK	EX	FB	FFD	FPEB	FTK	FTK_V	ID	INVRM	MIP	RD	RECTK	RT	TD	TKP	VTK	WLI
•*		•	•	•		•	•		•	•	•	•	•	•	•	•	•	•	•	•	•	•	•	•	•	•

\*Only available on Narrow Stile (N) cabinets    \*Not available on 84" tall

**Construction Upgrades**

APC	ET	PE
•		•

**Door Options**

CG.TOP	DPSRR	MFO
	•	•

**DOUBLE OVEN CABINET,  
DEEP DRAWER,  
93" or 96" TALL, 24" DEEP**

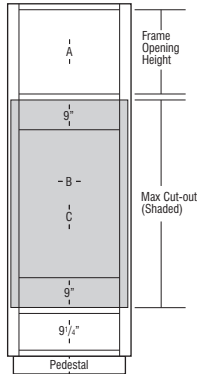
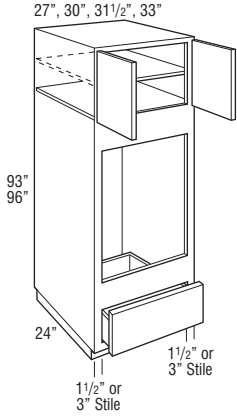

OCD \_ \_ \_ 24DD

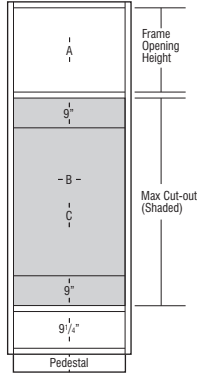

OCD \_ \_ \_ 24DDN

- OCD279324DD(N)
- OCD309324DD(N)
- OCD31.59324DD(N)
- OCD339324DD(N)
- OCD279624DD(N)
- OCD309624DD(N)
- OCD31.59624DD(N)
- OCD339624DD(N)

- N represents Narrow Stile cabinets with 1 1/2" wide face frame side stiles and ACS modification availability (see page 48 for ACS specifications). Doors and drawer fronts have a consistent 1/4" width reveal and use standard smart close hinges.
- On cabinets with 3" wide face frame side stiles, doors use face mount hinges. Doors and drawer fronts have a consistent 1/4" width reveal.
- All top and bottom cross rails are 1 1/2" wide.
- Be sure to confirm a heat shield is built into your appliance by the manufacturer or install the heat shield included with your appliance. Heat shields are sold separately as an accessory.
- Separate pedestal base included but packaged separately on 93" and 96" tall. Pedestal is designed to create a Recessed Left or Right Toekick application during field installation, or can be centered. Pedestal must be covered with toeboard material.
- One full depth adjustable shelf included, but packaged separately.
- Depth can be reduced to a minimum of 12".
- For built-in appliance support, OCINSTALLKIT is included in 24" deep oven cabinets (see page 373 for details). Oven install kit will not be included when depth is modified.
- OCINSTALLKIT weight limit is 400 lbs. per pair.
- Oven cabinets feature an open back in cut-out area designed to improve field appliance installation.
- Maximum cut-out dimension will allow 1/4" reveal for doors and drawer fronts for trim kit face clearance.

	A Frame Opening Height	B Cut-out Width		C Cut-out Height		Door Height (Upper Section)
		Min.	Max.	Min.	Max.	Full Overlay
OCD279324DD	21"	21"	25 1/2"	37 1/4"	52 1/4"	23 1/2"
OCD309324DD	21"	24"	28 1/2"	37 1/4"	52 1/4"	23 1/2"
OCD31.59324DD	21"	25 1/2"	30"	37 1/4"	52 1/4"	23 1/2"
OCD339324DD	21"	27"	31 1/2"	37 1/4"	52 1/4"	23 1/2"
OCD279624DD	24"	21"	25 1/2"	37 1/4"	52 1/4"	26 1/2"
OCD309624DD	24"	24"	28 1/2"	37 1/4"	52 1/4"	26 1/2"
OCD31.59624DD	24"	25 1/2"	30"	37 1/4"	52 1/4"	26 1/2"
OCD339624DD	24"	27"	31 1/2"	37 1/4"	52 1/4"	26 1/2"

	A Frame Opening Height	B Cut-out Width (standard)		B Cut-out Width (with ACS modification)			C Cut-out Height		Door Height (Upper Section)
		Min.	Max.	Min.	Max.	Max. w/ Field Cut	Min.	Max.	Full Overlay
OCD279324DDN	21"	24"	25 1/2"	21"	24"	25 1/2"	37 1/4"	52 1/4"	23 1/2"
OCD309324DDN	21"	27"	28 1/2"	24"	27"	28 1/2"	37 1/4"	52 1/4"	23 1/2"
OCD31.59324DDN	21"	28 1/2"	30"	25 1/2"	28 1/2"	30"	37 1/4"	52 1/4"	23 1/2"
OCD339324DDN	21"	30"	31 1/2"	27"	30"	31 1/2"	37 1/4"	52 1/4"	23 1/2"
OCD279624DDN	24"	24"	25 1/2"	21"	24"	25 1/2"	37 1/4"	52 1/4"	26 1/2"
OCD309624DDN	24"	27"	28 1/2"	24"	27"	28 1/2"	37 1/4"	52 1/4"	26 1/2"
OCD31.59624DDN	24"	28 1/2"	30"	25 1/2"	28 1/2"	30"	37 1/4"	52 1/4"	26 1/2"
OCD339624DDN	24"	30"	31 1/2"	27"	30"	31 1/2"	37 1/4"	52 1/4"	26 1/2"

**Custom Modifications**

ACS	ADDTK	AUTH	CBO	CCO	CFNTO	CFRMO	CND	DRT	DRWTK	EXBK	EX	FB	FFD	FPFB	FTK	FTK_V	ID	INVRM	MIP	RD	RECTK	RT	TD	TKP	VTK	WLI
•*																										

\*Only available on Narrow Stile (N) cabinets

**Construction Upgrades**

APC	ET	PE
•		•

**Door Options**

CG.TOP	DPSRR	MFO
	•	•

**DOUBLE OVEN CABINET,  
WARMING DRAWER,  
84", 87", 90", 93", or 96" TALL,  
24" DEEP**

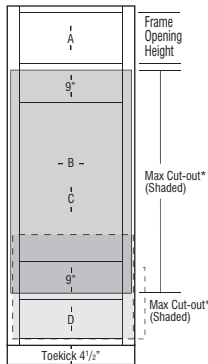
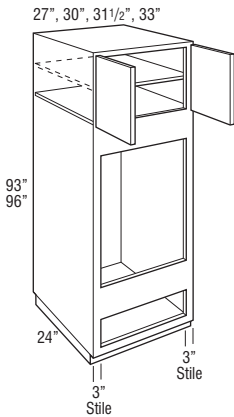
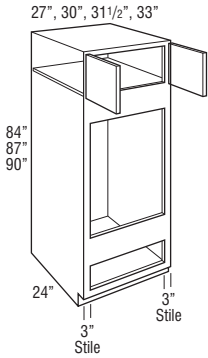

\*Minimum rail height between oven and warming drawer is 1 1/2"

- OCD278424WD
- OCD308424WD
- OCD31.58424WD
- OCD338424WD
- OCD278724WD
- OCD308724WD
- OCD31.58724WD
- OCD338724WD
- OCD279024WD
- OCD309024WD
- OCD31.59024WD
- OCD339024WD

- OCD279324WD
- OCD309324WD
- OCD31.59324WD
- OCD339324WD
- OCD279624WD
- OCD309624WD
- OCD31.59624WD
- OCD339624WD

- Includes one adjustable shelf in upper section of 93" and 96" tall.
- Uses face mount hinges, doors have a consistent 1/4" width reveal.
- All top and bottom cross rails are 1 1/2" wide.
- Be sure to confirm a heat shield is built into your appliance by the manufacturer or install the heat shield included with your appliance. Heat shields are sold separately as an accessory.
- Separate pedestal base included but packaged separately on 93" and 96" tall. Pedestal is designed to create a Recessed Left or Right Toe Kick application during field installation, or can be centered. Pedestal must be covered with toeboard material.
- Depth can be reduced to a minimum of 6". For depths of 6"-8", cabinet will not include toe kick/pedestal.
- For built-in appliance support, OCINSTALLKIT is included in 24" deep oven cabinets (see page 373 for details). Oven install kit will not be included when depth is modified.
- OCINSTALLKIT weight limit is 400 lbs. per pair.
- Oven cabinets feature an open back in cut-out area designed to improve field appliance installation.
- Maximum cut-out dimension will allow 1/4" reveal for doors for trim kit face clearance.

	A Frame Opening Height	B Cut-out Width		C Cut-out Height		D Warming Drawer Cut-out Height		Door Height (Upper Section) Full Overlay
		Min.	Max.	Min.	Max.	Min.	Max.	
OCD278424WD	12"	21"	25 1/2"	37 1/4"	52 1/4"	9 1/4"	16 3/4"	14 1/2"
OCD308424WD	12"	24"	28 1/2"	37 1/4"	52 1/4"	9 1/4"	16 3/4"	14 1/2"
OCD31.58424WD	12"	25 1/2"	30"	37 1/4"	52 1/4"	9 1/4"	16 3/4"	14 1/2"
OCD338424WD	12"	27"	31 1/2"	37 1/4"	52 1/4"	9 1/4"	16 3/4"	14 1/2"
OCD278724WD	15"	21"	25 1/2"	37 1/4"	52 1/4"	9 1/4"	16 3/4"	17 1/2"
OCD308724WD	15"	24"	28 1/2"	37 1/4"	52 1/4"	9 1/4"	16 3/4"	17 1/2"
OCD31.58724WD	15"	25 1/2"	30"	37 1/4"	52 1/4"	9 1/4"	16 3/4"	17 1/2"
OCD338724WD	15"	27"	31 1/2"	37 1/4"	52 1/4"	9 1/4"	16 3/4"	17 1/2"
OCD279024WD	18"	21"	25 1/2"	37 1/4"	52 1/4"	9 1/4"	16 3/4"	20 1/2"
OCD309024WD	18"	24"	28 1/2"	37 1/4"	52 1/4"	9 1/4"	16 3/4"	20 1/2"
OCD31.59024WD	18"	25 1/2"	30"	37 1/4"	52 1/4"	9 1/4"	16 3/4"	20 1/2"
OCD339024WD	18"	27"	31 1/2"	37 1/4"	52 1/4"	9 1/4"	16 3/4"	20 1/2"
OCD279324WD	21"	21"	25 1/2"	37 1/4"	52 1/4"	9 1/4"	16 3/4"	23 1/2"
OCD309324WD	21"	24"	28 1/2"	37 1/4"	52 1/4"	9 1/4"	16 3/4"	23 1/2"
OCD31.59324WD	21"	25 1/2"	30"	37 1/4"	52 1/4"	9 1/4"	16 3/4"	23 1/2"
OCD339324WD	21"	27"	31 1/2"	37 1/4"	52 1/4"	9 1/4"	16 3/4"	23 1/2"
OCD279624WD	24"	21"	25 1/2"	37 1/4"	52 1/4"	9 1/4"	16 3/4"	26 1/2"
OCD309624WD	24"	24"	28 1/2"	37 1/4"	52 1/4"	9 1/4"	16 3/4"	26 1/2"
OCD31.59624WD	24"	25 1/2"	30"	37 1/4"	52 1/4"	9 1/4"	16 3/4"	26 1/2"
OCD339624WD	24"	27"	31 1/2"	37 1/4"	52 1/4"	9 1/4"	16 3/4"	26 1/2"

**Custom Modifications**

ACS	ADTK	AUTH	CBO	CCO	CFNTO	CFRMO	CND	DRT	DRWTK	EXBK	EX	FB	FFD	FPFB	FTK	FTK_V	ID	INVFRM	MIP	RD	RECTK	RT	TD	TKP	VTK	WLI	
			•	•*					•																		

\*Not available on 84", 87", and 90" tall    \*Not available on 93" and 96" tall    \*Not available on 84" tall

**Construction Upgrades**

APC	ET	PE
•		•

**Door Options**

CG.TOP	DPSRR	MFO
	•	•

**DOUBLE OVEN CABINET,  
WARMING DRAWER with  
EXTENDED OPENING,  
84", 87", 90", 93", or 96" TALL,  
24" DEEP**

250

TALL CABINETS

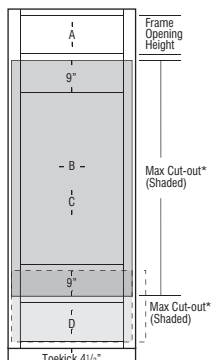
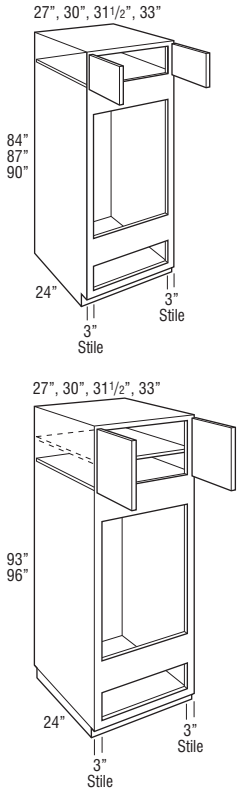

\*Minimum rail height between oven and warming drawer is 1 1/2"

- OCD278424WDE
- OCD308424WDE
- OCD31.58424WDE
- OCD338424WDE
- OCD278724WDE
- OCD308724WDE
- OCD31.58724WDE
- OCD338724WDE
- OCD279024WDE
- OCD309024WDE
- OCD31.59024WDE
- OCD339024WDE

- OCD279324WDE
- OCD309324WDE
- OCD31.59324WDE
- OCD339324WDE
- OCD279624WDE
- OCD309624WDE
- OCD31.59624WDE
- OCD339624WDE

- Includes one adjustable shelf in upper section of 93" and 96" tall.
- Uses face mount hinges, doors have a consistent 1/4" width reveal.
- All top and bottom cross rails are 1 1/2" wide.
- Standard interior (matching interior not required).
- Be sure to confirm a heat shield is built into your appliance by the manufacturer or install the heat shield included with your appliance. Heat shields are sold separately as an accessory.
- Separate pedestal base included but packaged separately on 93" and 96" tall. Pedestal is designed to create a Recessed Left or Right Toe-kick application during field installation, or can be centered. Pedestal must be covered with toeboard material.
- Depth can be reduced to a minimum of 6". For depths of 6"-8", cabinet will not include toe-kick/pedestal.
- For built-in appliance support, OCINSTALLKIT is included in 24" deep oven cabinets (see page 373 for details). Oven install kit will not be included when depth is modified.
- OCINSTALLKIT weight limit is 400 lbs. per pair.
- Oven cabinets feature an open back in cut-out area designed to improve field appliance installation.
- Maximum cut-out dimension will allow 1/4" reveal for doors for trim kit face clearance.

	A Frame Opening Height	B Cut-out Width		C Cut-out Height		D Warming Drawer Cut-out Height		Door Height (Upper Section)
		Min.	Max.	Min.	Max.	Min.	Max.	Full Overlay
OCD278424WDE	9"	21"	25 1/2"	40 1/4"	55 1/4"	9 1/4"	16 3/4"	11 1/2"
OCD308424WDE	9"	24"	28 1/2"	40 1/4"	55 1/4"	9 1/4"	16 3/4"	11 1/2"
OCD31.58424WDE	9"	25 1/2"	30"	40 1/4"	55 1/4"	9 1/4"	16 3/4"	11 1/2"
OCD338424WDE	9"	27"	31 1/2"	40 1/4"	55 1/4"	9 1/4"	16 3/4"	11 1/2"
OCD278724WDE	12"	21"	25 1/2"	40 1/4"	55 1/4"	9 1/4"	16 3/4"	14 1/2"
OCD308724WDE	12"	24"	28 1/2"	40 1/4"	55 1/4"	9 1/4"	16 3/4"	14 1/2"
OCD31.58724WDE	12"	25 1/2"	30"	40 1/4"	55 1/4"	9 1/4"	16 3/4"	14 1/2"
OCD338724WDE	12"	27"	31 1/2"	40 1/4"	55 1/4"	9 1/4"	16 3/4"	14 1/2"
OCD279024WDE	15"	21"	25 1/2"	40 1/4"	55 1/4"	9 1/4"	16 3/4"	17 1/2"
OCD309024WDE	15"	24"	28 1/2"	40 1/4"	55 1/4"	9 1/4"	16 3/4"	17 1/2"
OCD31.59024WDE	15"	25 1/2"	30"	40 1/4"	55 1/4"	9 1/4"	16 3/4"	17 1/2"
OCD339024WDE	15"	27"	31 1/2"	40 1/4"	55 1/4"	9 1/4"	16 3/4"	17 1/2"
OCD279324WDE	18"	21"	25 1/2"	40 1/4"	55 1/4"	9 1/4"	16 3/4"	20 1/2"
OCD309324WDE	18"	24"	28 1/2"	40 1/4"	55 1/4"	9 1/4"	16 3/4"	20 1/2"
OCD31.59324WDE	18"	25 1/2"	30"	40 1/4"	55 1/4"	9 1/4"	16 3/4"	20 1/2"
OCD339324WDE	18"	27"	31 1/2"	40 1/4"	55 1/4"	9 1/4"	16 3/4"	20 1/2"
OCD279624WDE	21"	21"	25 1/2"	40 1/4"	55 1/4"	9 1/4"	16 3/4"	23 1/2"
OCD309624WDE	21"	24"	28 1/2"	40 1/4"	55 1/4"	9 1/4"	16 3/4"	23 1/2"
OCD31.59624WDE	21"	25 1/2"	30"	40 1/4"	55 1/4"	9 1/4"	16 3/4"	23 1/2"
OCD339624WDE	21"	27"	31 1/2"	40 1/4"	55 1/4"	9 1/4"	16 3/4"	23 1/2"

**Custom Modifications**

ACS	ADDTK	AUTH	CBO	CCO	CFNTO	CFRMO	CND	DRT	DRWTK	EXBK	EX	FB	FFD	FPFB	FTK	FTK_V	ID	INFRM	MIP	RD	RECTK	RT	TD	TKP	VTK	WLI	

\*Not available on 84", 87", 90", and 93" tall \*Not available on 93" and 96" tall

**Construction Upgrades**

APC	ET	PE
•		•

**Door Options**

CG.TOP	DPSRR	MFO
	•	•



**TALL BUILT-IN MICROWAVE CABINET, 84", 87", or 90" TALL**

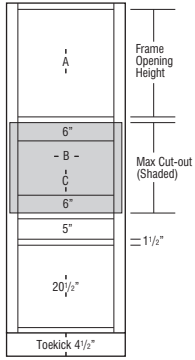
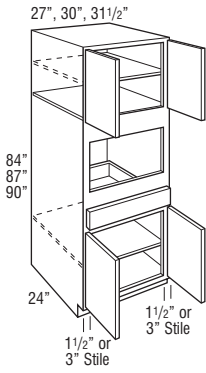

**TBMWB** \_ \_ \_ **24**

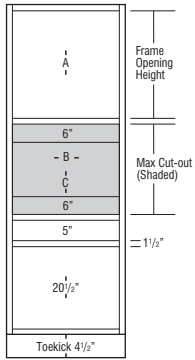

**TBMWB** \_ \_ \_ **24N**

- TBMWB278424(N)**
- TBMWB308424(N)**
- TBMWB31.58424(N)**
- TBMWB278724(N)**
- TBMWB308724(N)**
- TBMWB31.58724(N)**
- TBMWB279024(N)**
- TBMWB309024(N)**
- TBMWB31.59024(N)**

- N represents Narrow Stile cabinets with 1 1/2" wide face frame side stiles and ACS modification availability (see page 48 for ACS specifications). Doors and drawer fronts have a consistent 1/4" width reveal and use standard smart close hinges.
- On cabinets with 3" wide face frame side stiles, doors use face mount hinges. Doors and drawer fronts have a consistent 1/4" width reveal.
- Cabinets with 3" wide face frames are not available in Door 37 Decorative Laminate, or Door 15, Door 18, and Door 32 MDF door styles.
- Includes adjustable shelves in upper section:
  - 84" tall - one shelf
  - 87"-90" tall - two shelves
- Base section will utilize a full depth shelf.
- All top and bottom cross rails are 1 1/2" wide.
- All toekick areas are 4 1/2" high.
- Includes OCINSTALLKIT for microwave installation.
- OCINSTALLKIT weight limit is 400 lbs. per pair.
- Maximum cut-out dimension will allow 1/4" reveal for doors and drawer fronts for trim kit face clearance.

	A Frame Opening Height	B Cut-out Width		C Cut-out Height		Door Height (Upper Section)
		Min.	Max.	Min.	Max.	Full Overlay
TBMWB278424	24"	21"	25 1/2"	13 1/2"	22 1/2"	26 1/2"
TBMWB308424	24"	24"	28 1/2"	13 1/2"	22 1/2"	26 1/2"
TBMWB31.58424	24"	25 1/2"	30"	13 1/2"	22 1/2"	26 1/2"
TBMWB278724	27"	21"	25 1/2"	13 1/2"	22 1/2"	29 1/2"
TBMWB308724	27"	24"	28 1/2"	13 1/2"	22 1/2"	29 1/2"
TBMWB31.58724	27"	25 1/2"	30"	13 1/2"	22 1/2"	29 1/2"
TBMWB279024	30"	21"	25 1/2"	13 1/2"	22 1/2"	32 1/2"
TBMWB309024	30"	24"	28 1/2"	13 1/2"	22 1/2"	32 1/2"
TBMWB31.59024	30"	25 1/2"	30"	13 1/2"	22 1/2"	32 1/2"

	A Frame Opening Height	B Cut-out Width (standard)		B Cut-out Width (with ACS modification)			C Cut-out Height		Door Height (Upper Section)
		Min.	Max.	Min.	Max.	Max. w/ Field Cut	Min.	Max.	Full Overlay
TBMWB278424N	24"	24"	25 1/2"	21"	24"	25 1/2"	13 1/2"	22 1/2"	26 1/2"
TBMWB308424N	24"	27"	28 1/2"	24"	27"	28 1/2"	13 1/2"	22 1/2"	26 1/2"
TBMWB31.58424N	24"	28 1/2"	30"	25 1/2"	28 1/2"	30"	13 1/2"	22 1/2"	26 1/2"
TBMWB278724N	27"	24"	25 1/2"	21"	24"	25 1/2"	13 1/2"	22 1/2"	29 1/2"
TBMWB308724N	27"	27"	28 1/2"	24"	27"	28 1/2"	13 1/2"	22 1/2"	29 1/2"
TBMWB31.58724N	27"	28 1/2"	30"	25 1/2"	28 1/2"	30"	13 1/2"	22 1/2"	29 1/2"
TBMWB279024N	30"	24"	25 1/2"	21"	24"	25 1/2"	13 1/2"	22 1/2"	32 1/2"
TBMWB309024N	30"	27"	28 1/2"	24"	27"	28 1/2"	13 1/2"	22 1/2"	32 1/2"
TBMWB31.59024N	30"	28 1/2"	30"	25 1/2"	28 1/2"	30"	13 1/2"	22 1/2"	32 1/2"

**Custom Modifications**

ACS	ADDTK	AUTH	CBO	CCO	CFNTD	CFRMO	CND	DRT	DRWTK	EXBK	EX	FB	FFD	FPEB	FTK	FTK_V	ID	INVRM	MMP	RD	RECTK	RT	TD	TKP	VTK	WLI
•*	•	•	•	•	•	•	•	•	•	•	•	•	•	•	•	•	•	•	•	•	•	•	•	•	•	•

\*Only available on Narrow Stile (N) cabinets    †Not available on 90" tall

**Construction Upgrades**

APC	ET	PE
•	•	•

**Door Options**

CG.TOP	DPSRR	MFO
•†	•	•

†Only available on Narrow Stile (N) cabinets

**TALL BUILT-IN MICROWAVE CABINET, 93" or 96" TALL**

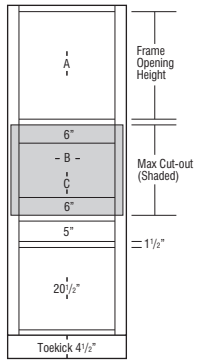
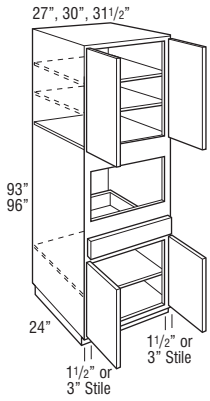

TBMWB\_ \_ \_ 24

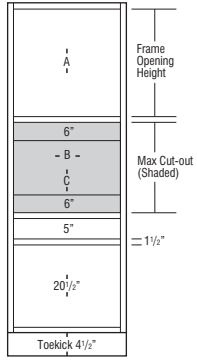

TBMWB\_ \_ \_ 24N

- TBMWB279324(N)
- TBMWB309324(N)
- TBMWB31.59324(N)
- TBMWB279624(N)
- TBMWB309624(N)
- TBMWB31.59624(N)

- N represents Narrow Stile cabinets with 1 1/2" wide face frame side stiles and ACS modification availability (see page 48 for ACS specifications). Doors and drawer fronts have a consistent 1/4" width reveal and use standard smart close hinges.
- On cabinets with 3" wide face frame side stiles, doors use face mount hinges. Doors and drawer fronts have a consistent 1/4" width reveal.
- Cabinets with 3" wide face frames are not available in Door 37 Decorative Laminate, or Door 15, Door 18, and Door 32 MDF door styles.
- Includes adjustable shelves in upper section:  
93" tall - two shelves  
96" tall - three shelves
- Base section will utilize a full depth shelf.
- All top and bottom cross rails are 1 1/2" wide.
- All toekick areas are 4 1/2" high.
- Separate pedestal base included but packaged separately on 93" and 96" tall. Pedestal is designed to create a Recessed Left or Right ToeKick application during field installation, or can be centered. Pedestal must be covered with toeboard material.
- Includes OCINSTALLKIT for microwave installation.
- OCINSTALLKIT weight limit is 400 lbs. per pair.
- Maximum cut-out dimension will allow 1/4" reveal for doors and drawer fronts for trim kit face clearance.

	A Frame Opening Height	B Cut-out Width		C Cut-out Height		Door Height (Upper Section)
		Min.	Max.	Min.	Max.	Full Overlay
TBMWB279324	33"	21"	25 1/2"	13 1/2"	22 1/2"	35 1/2"
TBMWB309324	33"	24"	28 1/2"	13 1/2"	22 1/2"	35 1/2"
TBMWB31.59324	33"	25 1/2"	30"	13 1/2"	22 1/2"	35 1/2"
TBMWB279624	36"	21"	25 1/2"	13 1/2"	22 1/2"	38 1/2"
TBMWB309624	36"	24"	28 1/2"	13 1/2"	22 1/2"	38 1/2"
TBMWB31.59624	36"	25 1/2"	30"	13 1/2"	22 1/2"	38 1/2"

	A Frame Opening Height	B Cut-out Width (standard)		B Cut-out Width (with ACS modification)			C Cut-out Height		Door Height (Upper Section)
		Min.	Max.	Min.	Max.	Max. w/ Field Cut	Min.	Max.	Full Overlay
TBMWB279324N	33"	24"	25 1/2"	21"	24"	25 1/2"	13 1/2"	22 1/2"	35 1/2"
TBMWB309324N	33"	27"	28 1/2"	24"	27"	28 1/2"	13 1/2"	22 1/2"	35 1/2"
TBMWB31.59324N	33"	28 1/2"	30"	25 1/2"	28 1/2"	30"	13 1/2"	22 1/2"	35 1/2"
TBMWB279624N	36"	24"	25 1/2"	21"	24"	25 1/2"	13 1/2"	22 1/2"	38 1/2"
TBMWB309624N	36"	27"	28 1/2"	24"	27"	28 1/2"	13 1/2"	22 1/2"	38 1/2"
TBMWB31.59624N	36"	28 1/2"	30"	25 1/2"	28 1/2"	30"	13 1/2"	22 1/2"	38 1/2"

**Custom Modifications**

ACS	ADDTK	AUTH	CBO	CCO	CFNTD	CFRMO	CND	DRT	DRWTK	EXBK	EX	FB	FFD	FPFB	FTK	FTK_V	ID	INVFRM	MIP	RD	RECTK_	RT	TD	TKP	VTK	WLI
•*		•	•	•		•	•			•	•	•	•	•	•	•			•	•	•	•	•	•	•	•

\*Only available on Narrow Stile (N) cabinets

**Construction Upgrades**

APC	ET	PE
•		•

**Door Options**

CG.TOP	DPSRR	MFO
•†	•	•

†Only available on Narrow Stile (N) cabinets

**OVEN MICROWAVE CABINET,  
84", 87", or 90" TALL, 24" DEEP**

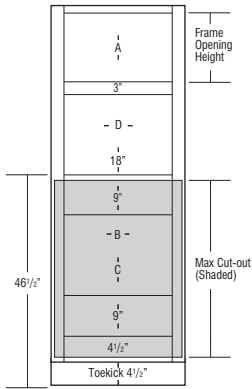
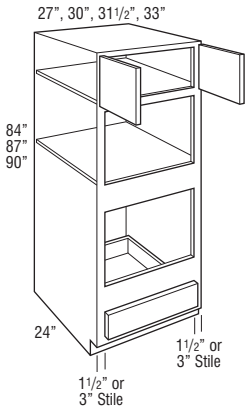

**OMC\_ \_24**

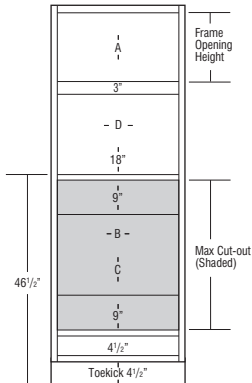

**OMC\_ \_24N**

- OMC278424(N)
- OMC308424(N)
- OMC31.58424(N)
- OMC338424(N)
- OMC278724(N)
- OMC308724(N)
- OMC31.58724(N)
- OMC338724(N)
- OMC279024(N)
- OMC309024(N)
- OMC31.59024(N)
- OMC339024(N)

- N represents Narrow Stile cabinets with 1 1/2" wide face frame side stiles and ACS modification availability (see page 48 for ACS specifications). Doors and drawer fronts have a consistent 1/4" width reveal and use standard smart close hinges.
- On cabinets with 3" wide face frame side stiles, doors use face mount hinges. Doors and drawer fronts have a consistent 1/4" width reveal.
- Cabinets with 3" wide face frames are not available in Door 37 Decorative Laminate, or Door 15, Door 18, and Door 32 MDF door styles.
- Upper section on 90" tall has one full depth adjustable shelf.
- Designed for use with separate built-in microwave above, built-in oven below. For built-in double ovens, see pages 245-250.
- All top and bottom cross rails are 1 1/2" wide.
- All toe kick areas are 4 1/2" high.
- Be sure to confirm a heat shield is built into your appliance by the manufacturer or install the heat shield included with your appliance. Heat shields are sold separately as an accessory.
- Depth can be reduced to a minimum of 12".
- For built-in appliance support, OCINSTALLKIT is included in 24" deep oven cabinets (see page 373 for details). Oven install kit will not be included when depth is modified.
- OCINSTALLKIT weight limit is 400 lbs. per pair.
- Maximum cut-out dimension will allow 1/4" reveal for doors and drawer fronts for trim kit face clearance.

	A Frame Opening Height	B Cut-out Width		C Cut-out Height		D Frame Opening Width	Door Height (Upper Section) Full Overlay	
		Min.	Max.	Min.	Max.		Min.	Max.
OMC278424	15"	21"	25 1/2"	18"	39"	21"	17 1/2"	17 1/2"
OMC308424	15"	24"	28 1/2"	18"	39"	24"	17 1/2"	17 1/2"
OMC31.58424	15"	25 1/2"	30"	18"	39"	25 1/2"	17 1/2"	17 1/2"
OMC338424	15"	27"	31 1/2"	18"	39"	27"	17 1/2"	17 1/2"
OMC278724	18"	21"	25 1/2"	18"	39"	21"	20 1/2"	20 1/2"
OMC308724	18"	24"	28 1/2"	18"	39"	24"	20 1/2"	20 1/2"
OMC31.58724	18"	25 1/2"	30"	18"	39"	25 1/2"	20 1/2"	20 1/2"
OMC338724	18"	27"	31 1/2"	18"	39"	27"	20 1/2"	20 1/2"
OMC279024	21"	21"	25 1/2"	18"	39"	21"	23 1/2"	23 1/2"
OMC309024	21"	24"	28 1/2"	18"	39"	24"	23 1/2"	23 1/2"
OMC31.59024	21"	25 1/2"	30"	18"	39"	25 1/2"	23 1/2"	23 1/2"
OMC339024	21"	27"	31 1/2"	18"	39"	27"	23 1/2"	23 1/2"

	A Frame Opening Height	B Cut-out Width (standard)		B Cut-out Width (with ACS modification)			C Cut-out Height		D Frame Opening Width	Door Height (Upper Section) Full Overlay	
		Min.	Max.	Min.	Max.	Max. w/ Field Cut	Min.	Max.		Min.	Max.
OMC308424N	15"	27"	28 1/2"	24"	27"	28 1/2"	18"	33"	27"	17 1/2"	
OMC31.58424N	15"	28 1/2"	30"	25 1/2"	28 1/2"	30"	18"	39"	28 1/2"	17 1/2"	
OMC338424N	15"	30"	31 1/2"	27"	30"	31 1/2"	18"	33"	30"	17 1/2"	
OMC278724N	18"	24"	25 1/2"	21"	24"	25 1/2"	18"	33"	24"	20 1/2"	
OMC308724N	18"	27"	28 1/2"	24"	27"	28 1/2"	18"	33"	27"	20 1/2"	
OMC31.58724N	18"	28 1/2"	30"	25 1/2"	28 1/2"	30"	18"	39"	28 1/2"	20 1/2"	
OMC338724N	18"	30"	31 1/2"	27"	30"	31 1/2"	18"	33"	30"	20 1/2"	
OMC279024N	21"	24"	25 1/2"	21"	24"	25 1/2"	18"	33"	24"	23 1/2"	
OMC309024N	21"	27"	28 1/2"	24"	27"	28 1/2"	18"	33"	27"	23 1/2"	
OMC31.59024N	21"	28 1/2"	30"	25 1/2"	28 1/2"	30"	18"	39"	28 1/2"	23 1/2"	
OMC339024N	21"	30"	31 1/2"	27"	30"	31 1/2"	18"	33"	30"	23 1/2"	

**Custom Modifications**

ACS	ADDTK	AUTH	CBO	CCO	CFNTO	CFRMO	CND	DRT	DRWTK	EXBK	EX	FB	FFD	FPEB	FTK	FTK_V	ID	INVFRM	MIP	RD	RECTK	RT	TD	TKP	VTK	WLI
•*	•	•	•	•	•	•	•	•	•	•	•	•	•	•	•	•	•	•	•	•	•	•	•	•	•	•

\*Only available on Narrow Stile (N) cabinets

**Construction Upgrades**

APC	ET	PE
•	•	•

**Door Options**

CG.TOP	DPSRR	MFO
•	•	•

**OVEN MICROWAVE CABINET,  
93" or 96" TALL, 24" DEEP**

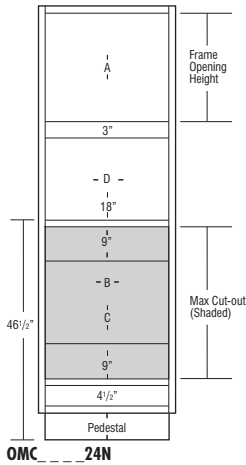
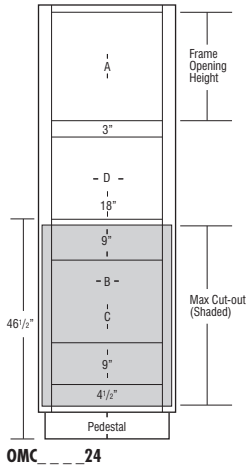
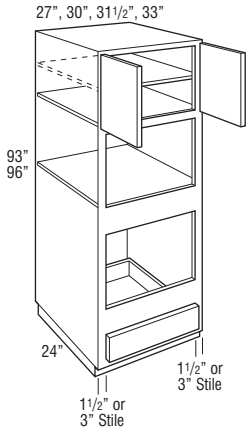

- OMC279324(N)**
- OMC309324(N)**
- OMC31.59324(N)**
- OMC339324(N)**
- OMC279624(N)**
- OMC309624(N)**
- OMC31.59624(N)**
- OMC339624(N)**

- N represents Narrow Stile cabinets with 1 1/2" wide face frame side stiles and ACS modification availability (see page 48 for ACS specifications). Doors and drawer fronts have a consistent 1/4" width reveal and use standard smart close hinges.
- On cabinets with 3" wide face frame side stiles, doors use face mount hinges. Doors and drawer fronts have a consistent 1/4" width reveal.
- Cabinets with 3" wide face frames are not available in Door 37 Decorative Laminate, or Door 15, Door 18, and Door 32 MDF door styles.
- Includes adjustable shelves in upper section:  
93" tall - one shelf  
96" tall - two shelves
- Designed for use with separate built-in microwave above, built-in oven below. For built-in double ovens, see pages 245-250.
- All top and bottom cross rails are 1 1/2" wide.
- All toekick areas are 4 1/2" high.
- Be sure to confirm a heat shield is built into your appliance by the manufacturer or install the heat shield included with your appliance. Heat shields are sold separately as an accessory.
- Separate pedestal base included but packaged separately on 93" and 96" tall. Pedestal is designed to create a Recessed Left or Right Toekick application during field installation, or can be centered. Pedestal must be covered with toeboard material.
- Depth can be reduced to a minimum of 12".
- For built-in appliance support, OCINSTALLKIT is included in 24" deep oven cabinets (see page 373 for details). Oven install kit will not be included when depth is modified.
- OCINSTALLKIT weight limit is 400 lbs. per pair.
- Maximum cut-out dimension will allow 1/4" reveal for doors and drawer fronts for trim kit face clearance.

	A Frame Opening Height	B Cut-out Width		C Cut-out Height		D Frame Opening Width	Door Height (Upper Section) Full Overlay
		Min.	Max.	Min.	Max.		
OMC279324	24"	21"	25 1/2"	18"	39"	21"	26 1/2"
OMC309324	24"	24"	28 1/2"	18"	39"	24"	26 1/2"
OMC31.59324	24"	25 1/2"	30"	18"	39"	25 1/2"	26 1/2"
OMC339324	24"	27"	31 1/2"	18"	39"	27"	26 1/2"
OMC279624	27"	21"	25 1/2"	18"	39"	21"	29 1/2"
OMC309624	27"	24"	28 1/2"	18"	39"	24"	29 1/2"
OMC31.59624	27"	25 1/2"	30"	18"	39"	25 1/2"	29 1/2"
OMC339624	27"	27"	31 1/2"	18"	39"	27"	29 1/2"

	A Frame Opening Height	B Cut-out Width (standard)		B Cut-out Width (with ACS modification)			C Cut-out Height		D Frame Opening Width	Door Height (Upper Section) Full Overlay
		Min.	Max.	Min.	Max.	Max. w/ Field Cut	Min.	Max.		
OMC309324N	24"	27"	28 1/2"	24"	27"	28 1/2"	18"	33"	27"	26 1/2"
OMC31.59324N	24"	28 1/2"	30"	25 1/2"	28 1/2"	30"	18"	39"	28 1/2"	26 1/2"
OMC339324N	24"	30"	31 1/2"	27"	30"	31 1/2"	18"	33"	30"	26 1/2"
OMC279624N	27"	24"	25 1/2"	21"	24"	25 1/2"	18"	33"	24"	29 1/2"
OMC309624N	27"	27"	28 1/2"	24"	27"	28 1/2"	18"	33"	27"	29 1/2"
OMC31.59624N	27"	28 1/2"	30"	25 1/2"	28 1/2"	30"	18"	39"	28 1/2"	29 1/2"
OMC339624N	27"	30"	31 1/2"	27"	30"	31 1/2"	18"	33"	30"	29 1/2"

**Custom Modifications**

ACS	ADDTK	AUTH	CBO	CCO	CFNTD	CFRMO	CND	DRT	DRWTK	EXBK	EX	FB	FED	FPFB	FTK	FTK_V	ID	INVRM	MIP	RD	RECTK	RT	TD	TKP	VTK	WLI
•*		•	•	•		•	•			•	•	•	•	•	•	•	•	•	•	•	•	•	•	•	•	•

\*Only available on Narrow Stile (N) cabinets

**Construction Upgrades**

APC	ET	PE
•		•

**Door Options**

CG.TOP	DPSRR	MFO
	•	•

**OVEN MICROWAVE CABINET,  
DEEP DRAWER,  
84", 87", or 90" TALL, 24" DEEP**

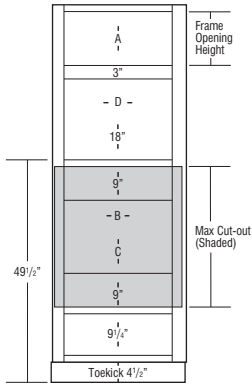
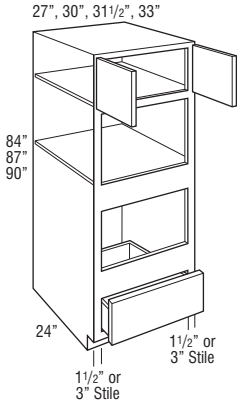

**OMC --- 24DD**

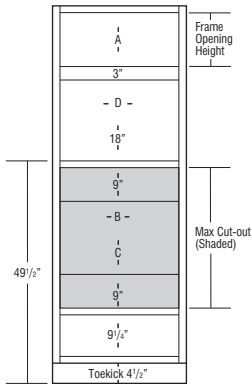

**OMC --- 24DDN**

- OMC278424DD(N)**
- OMC308424DD(N)**
- OMC31.58424DD(N)**
- OMC338424DD(N)**
- OMC278724DD(N)**
- OMC308724DD(N)**
- OMC31.58724DD(N)**
- OMC338724DD(N)**
- OMC279024DD(N)**
- OMC309024DD(N)**
- OMC31.59024DD(N)**
- OMC339024DD(N)**

- N represents Narrow Stile cabinets with 1 1/2" wide face frame side stiles and ACS modification availability (see page 48 for ACS specifications). Doors and drawer fronts have a consistent 1/4" width reveal and use standard smart close hinges.
- On cabinets with 3" wide face frame side stiles, doors use face mount hinges. Doors and drawer fronts have a consistent 1/4" width reveal.
- Designed for use with separate built-in microwave above, built-in oven below. For built-in double ovens, see pages 245-250.
- All top and bottom cross rails are 1 1/2" wide.
- All toe kick areas are 4 1/2" high.
- Be sure to confirm a heat shield is built into your appliance by the manufacturer or install the heat shield included with your appliance. Heat shields are sold separately as an accessory.
- Depth can be reduced to a minimum of 12".
- For built-in appliance support, OCINSTALLKIT is included in 24" deep oven cabinets (see page 373 for details). Oven install kit will not be included when depth is modified.
- OCINSTALLKIT weight limit is 400 lbs. per pair.
- Maximum cut-out dimension will allow 1/4" reveal for doors and drawer fronts for trim kit face clearance.

	A Frame Opening Height	B Cut-out Width		C Cut-out Height		D Frame Opening Width	Door Height (Upper Section)
		Min.	Max.	Min.	Max.		Full Overlay
OMC278424DD	12"	21"	25 1/2"	16 1/4"	31 1/4"	21"	14 1/2"
OMC308424DD	12"	24"	28 1/2"	16 1/4"	31 1/4"	24"	14 1/2"
OMC31.58424DD	12"	25 1/2"	30"	16 1/4"	31 1/4"	25 1/2"	14 1/2"
OMC338424DD	12"	27"	31 1/2"	16 1/4"	31 1/4"	27"	14 1/2"
OMC278724DD	15"	21"	25 1/2"	16 1/4"	31 1/4"	21"	17 1/2"
OMC308724DD	15"	24"	28 1/2"	16 1/4"	31 1/4"	24"	17 1/2"
OMC31.58724DD	15"	25 1/2"	30"	16 1/4"	31 1/4"	25 1/2"	17 1/2"
OMC338724DD	15"	27"	31 1/2"	16 1/4"	31 1/4"	27"	17 1/2"
OMC279024DD	18"	21"	25 1/2"	16 1/4"	31 1/4"	21"	20 1/2"
OMC309024DD	18"	24"	28 1/2"	16 1/4"	31 1/4"	24"	20 1/2"
OMC31.59024DD	18"	25 1/2"	30"	16 1/4"	31 1/4"	25 1/2"	20 1/2"
OMC339024DD	18"	27"	31 1/2"	16 1/4"	31 1/4"	27"	20 1/2"

	A Frame Opening Height	B Cut-out Width (standard)		B Cut-out Width (with ACS modification)			C Cut-out Height		D Frame Opening Width	Door Height (Upper Section)
		Min.	Max.	Min.	Max.	Max. w/ Field Cut	Min.	Max.		Full Overlay
OMC278424DDN	12"	24"	25 1/2"	21"	24"	25 1/2"	16 1/4"	31 1/4"	24"	14 1/2"
OMC308424DDN	12"	27"	28 1/2"	24"	27"	28 1/2"	16 1/4"	31 1/4"	27"	14 1/2"
OMC31.58424DDN	12"	28 1/2"	30"	25 1/2"	28 1/2"	30"	16 1/4"	31 1/4"	28 1/2"	14 1/2"
OMC338424DDN	12"	30"	31 1/2"	27"	30"	31 1/2"	16 1/4"	31 1/4"	30"	14 1/2"
OMC278724DDN	15"	24"	25 1/2"	21"	24"	25 1/2"	16 1/4"	31 1/4"	24"	17 1/2"
OMC308724DDN	15"	27"	28 1/2"	24"	27"	28 1/2"	16 1/4"	31 1/4"	27"	17 1/2"
OMC31.58724DDN	15"	28 1/2"	30"	25 1/2"	28 1/2"	30"	16 1/4"	31 1/4"	28 1/2"	17 1/2"
OMC338724DDN	15"	30"	31 1/2"	27"	30"	31 1/2"	16 1/4"	31 1/4"	30"	17 1/2"
OMC279024DDN	18"	24"	25 1/2"	21"	24"	25 1/2"	16 1/4"	31 1/4"	24"	20 1/2"
OMC309024DDN	18"	27"	28 1/2"	24"	27"	28 1/2"	16 1/4"	31 1/4"	27"	20 1/2"
OMC31.59024DDN	18"	28 1/2"	30"	25 1/2"	28 1/2"	30"	16 1/4"	31 1/4"	28 1/2"	20 1/2"
OMC339024DDN	18"	30"	31 1/2"	27"	30"	31 1/2"	16 1/4"	31 1/4"	30"	20 1/2"

**Custom Modifications**

ACS	ADDTK	AUTH	CBO	CCO	CFNTD	CFRMO	CND	DRT	DRWTK	EXBK	EX	FB	FFD	FPEB	FTK	FTK_V	ID	INVRM	MIP	RD	RECTK	RT	TD	TKP	VTK	WLI
•*	•	•	•	•	•	•	•	•	•	•	•	•	•	•	•	•	•	•	•	•	•	•	•	•	•	•

\*Only available on Narrow Stile (N) cabinets \*Not available on 84" tall

**Construction Upgrades**

APC	ET	PE
•	•	•

**Door Options**

CG.TOP	DPSRR	MFO
•	•	•

**OVEN MICROWAVE CABINET,  
DEEP DRAWER,  
93" or 96" TALL, 24" DEEP**

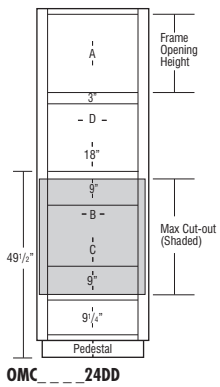
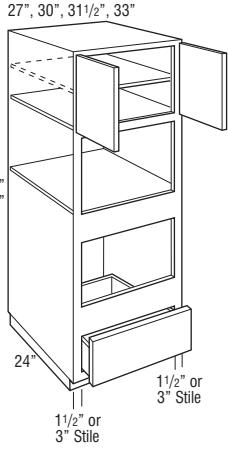

OMC \_\_\_ 24DD

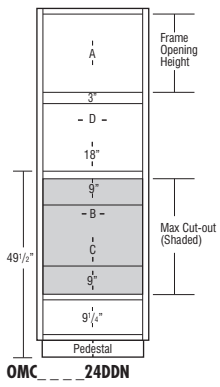

OMC \_\_\_ 24DDN

- OMC279324DD(N)**
- OMC309324DD(N)**
- OMC31.59324DD(N)**
- OMC339324DD(N)**
- OMC279624DD(N)**
- OMC309624DD(N)**
- OMC31.59624DD(N)**
- OMC339624DD(N)**

- N represents Narrow Stile cabinets with 1 1/2" wide face frame side stiles and ACS modification availability (see page 48 for ACS specifications). Doors and drawer fronts have a consistent 1/4" width reveal and use standard smart close hinges.
- On cabinets with 3" wide face frame side stiles, doors use face mount hinges. Doors and drawer fronts have a consistent 1/4" width reveal.
- Designed for use with separate built-in microwave above, built-in oven below. For built-in double ovens, see pages 245-250.
- All top and bottom cross rails are 1 1/2" wide.
- All toekick areas are 4 1/2" high.
- Be sure to confirm a heat shield is built into your appliance by the manufacturer or install the heat shield included with your appliance. Heat shields are sold separately as an accessory.
- Separate pedestal base included but packaged separately on 93" and 96" tall. Pedestal is designed to create a Recessed Left or Right Toekick application during field installation, or can be centered. Pedestal must be covered with toeboard material.
- One full depth adjustable shelf included, but packaged separately.
- Depth can be reduced to a minimum of 12".
- For built-in appliance support, OCINSTALLKIT is included in 24" deep oven cabinets (see page 373 for details). Oven install kit will not be included when depth is modified.
- OCINSTALLKIT weight limit is 400 lbs. per pair.
- Maximum cut-out dimension will allow 1/4" reveal for doors and drawer fronts for trim kit face clearance.

	A Frame Opening Height	B Cut-out Width		C Cut-out Height		D Frame Opening Width	Door Height (Upper Section)	
		Min.	Max.	Min.	Max.		Full Overlay	
OMC279324DD	21"	21"	25 1/2"	16 1/4"	31 1/4"	21"	23 1/2"	
OMC309324DD	21"	24"	28 1/2"	16 1/4"	31 1/4"	24"	23 1/2"	
OMC31.59324DD	21"	25 1/2"	30"	16 1/4"	31 1/4"	25 1/2"	23 1/2"	
OMC339324DD	21"	27"	31 1/2"	16 1/4"	31 1/4"	27"	23 1/2"	
OMC279624DD	24"	21"	25 1/2"	16 1/4"	31 1/4"	21"	26 1/2"	
OMC309624DD	24"	24"	28 1/2"	16 1/4"	31 1/4"	24"	26 1/2"	
OMC31.59624DD	24"	25 1/2"	30"	16 1/4"	31 1/4"	25 1/2"	26 1/2"	
OMC339624DD	24"	27"	31 1/2"	16 1/4"	31 1/4"	27"	26 1/2"	

	A Frame Opening Height	B Cut-out Width (standard)		B Cut-out Width (with ACS modification)			C Cut-out Height		D Frame Opening Width	Door Height (Upper Section)	
		Min.	Max.	Min.	Max.	Max. w/ Field Cut	Min.	Max.		Full Overlay	
											Full Overlay
OMC279324DDN	21"	24"	25 1/2"	21"	24"	25 1/2"	16 1/4"	31 1/4"	24"	23 1/2"	
OMC309324DDN	21"	27"	28 1/2"	24"	27"	28 1/2"	16 1/4"	31 1/4"	27"	23 1/2"	
OMC31.59324DDN	21"	28 1/2"	30"	25 1/2"	28 1/2"	30"	16 1/4"	31 1/4"	28 1/2"	23 1/2"	
OMC339324DDN	21"	30"	31 1/2"	27"	30"	31 1/2"	16 1/4"	31 1/4"	30"	23 1/2"	
OMC279624DDN	24"	24"	25 1/2"	21"	24"	25 1/2"	16 1/4"	31 1/4"	24"	26 1/2"	
OMC309624DDN	24"	27"	28 1/2"	24"	27"	28 1/2"	16 1/4"	31 1/4"	27"	26 1/2"	
OMC31.59624DDN	24"	28 1/2"	30"	25 1/2"	28 1/2"	30"	16 1/4"	31 1/4"	28 1/2"	26 1/2"	
OMC339624DDN	24"	30"	31 1/2"	27"	30"	31 1/2"	16 1/4"	31 1/4"	30"	26 1/2"	

**Custom Modifications**

ACS	ADDTK	AUTH	CBO	CCO	CFNTO	CFRMO	CND	DRT	DRWTK	EXBK	EX	FB	FFD	FPFB	FTK	FTK_V	ID	INVFRM	MIP	RD	RECTK_	RT	TD	TKP	VTK	WLI
•*		•	•	•			•	•			•	•	•	•	•	•	•		•	•	•	•	•	•	•	•

\*Only available on Narrow Stile (N) cabinets

**Construction Upgrades**

APC	ET	PE
•		•

**Door Options**

CG.TOP	DPSRR	MFO
	•	•

**OVEN MICROWAVE CABINET,  
WARMING DRAWER,  
84", 87", 90", 93", or 96" TALL,  
24" DEEP**

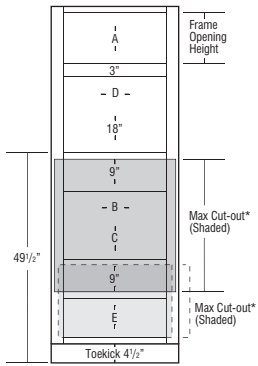
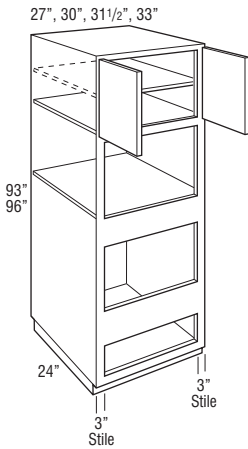
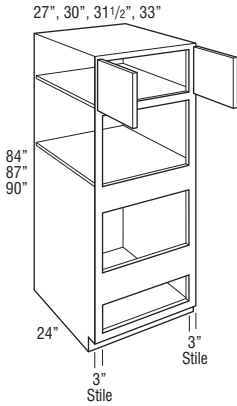

\*Minimum rail height between oven and warming drawer is 1 1/2"

- OMC278424WD
- OMC308424WD
- OMC31.58424WD
- OMC338424WD
- OMC278724WD
- OMC308724WD
- OMC31.58724WD
- OMC338724WD
- OMC279024WD
- OMC309024WD
- OMC31.59024WD
- OMC339024WD

- OMC279324WD
- OMC309324WD
- OMC31.59324WD
- OMC339324WD
- OMC279624WD
- OMC309624WD
- OMC31.59624WD
- OMC339624WD

- Includes one adjustable shelf in upper section of 93" and 96" tall.
- Designed for use with separate built-in microwave above, built-in oven below. For built-in double ovens, see pages 245-250.
- Uses face mount hinges, doors have a consistent 1/4" width reveal.
- All top and bottom cross rails are 1 1/2" wide.
- All toekick areas are 4 1/2" high.
- Be sure to confirm a heat shield is built into your appliance by the manufacturer or install the heat shield included with your appliance. Heat shields are sold separately as an accessory.
- Separate pedestal base included but packaged separately on 93" and 96" tall. Pedestal is designed to create a Recessed Left or Right Toekick application during field installation, or can be centered. Pedestal must be covered with toeboard material.
- Depth can be reduced to a minimum of 6". For depths of 6"-8", cabinet will not include toekick/pedestal.
- For built-in appliance support, OCINSTALLKIT is included in 24" deep oven cabinets (see page 373 for details). Oven install kit will not be included when depth is modified.
- OCINSTALLKIT weight limit is 400 lbs. per pair.
- Maximum cut-out dimension will allow 1/4" reveal for doors for trim kit face clearance.

	A Frame Opening Height	B Cut-out Width		C Cut-out Height		D Frame Opening Width	E Warming Drawer Cut-out Height		Door Height (Upper Section) Full Overlay
		Min.	Max.	Min.	Max.		Min.	Max.	
OMC278424WD	12"	21"	25 1/2"	16 1/4"	31 1/4"	21"	9 1/4"	16 3/4"	14 1/2"
OMC308424WD	12"	24"	28 1/2"	16 1/4"	31 1/4"	24"	9 1/4"	16 3/4"	14 1/2"
OMC31.58424WD	12"	25 1/2"	30"	16 1/4"	31 1/4"	25 1/2"	9 1/4"	16 3/4"	14 1/2"
OMC338424WD	12"	27"	31 1/2"	16 1/4"	31 1/4"	27"	9 1/4"	16 3/4"	14 1/2"
OMC278724WD	15"	21"	25 1/2"	16 1/4"	31 1/4"	21"	9 1/4"	16 3/4"	17 1/2"
OMC308724WD	15"	24"	28 1/2"	16 1/4"	31 1/4"	24"	9 1/4"	16 3/4"	17 1/2"
OMC31.58724WD	15"	25 1/2"	30"	16 1/4"	31 1/4"	25 1/2"	9 1/4"	16 3/4"	17 1/2"
OMC338724WD	15"	27"	31 1/2"	16 1/4"	31 1/4"	27"	9 1/4"	16 3/4"	17 1/2"
OMC279024WD	18"	21"	25 1/2"	16 1/4"	31 1/4"	21"	9 1/4"	16 3/4"	20 1/2"
OMC309024WD	18"	24"	28 1/2"	16 1/4"	31 1/4"	24"	9 1/4"	16 3/4"	20 1/2"
OMC31.59024WD	18"	25 1/2"	30"	16 1/4"	31 1/4"	25 1/2"	9 1/4"	16 3/4"	20 1/2"
OMC339024WD	18"	27"	31 1/2"	16 1/4"	31 1/4"	27"	9 1/4"	16 3/4"	20 1/2"
OMC279324WD	21"	21"	25 1/2"	16 1/4"	31 1/4"	21"	9 1/4"	16 3/4"	23 1/2"
OMC309324WD	21"	24"	28 1/2"	16 1/4"	31 1/4"	24"	9 1/4"	16 3/4"	23 1/2"
OMC31.59324WD	21"	25 1/2"	30"	16 1/4"	31 1/4"	25 1/2"	9 1/4"	16 3/4"	23 1/2"
OMC339324WD	21"	27"	31 1/2"	16 1/4"	31 1/4"	27"	9 1/4"	16 3/4"	23 1/2"
OMC279624WD	24"	21"	25 1/2"	16 1/4"	31 1/4"	21"	9 1/4"	16 3/4"	26 1/2"
OMC309624WD	24"	24"	28 1/2"	16 1/4"	31 1/4"	24"	9 1/4"	16 3/4"	26 1/2"
OMC31.59624WD	24"	25 1/2"	30"	16 1/4"	31 1/4"	25 1/2"	9 1/4"	16 3/4"	26 1/2"
OMC339624WD	24"	27"	31 1/2"	16 1/4"	31 1/4"	27"	9 1/4"	16 3/4"	26 1/2"

**Custom Modifications**

ACS	ADDTK	AUTH	CBO	CCO	CFNTO	CFRMO	CND	DRT	DRWTK	EXBK	EX	FB	FFD	FPEB	FTK	FTK_V	ID	INVRM	MMP	RD	RECTK	RT	TD	TKP	VTK	WLI	

\*Not available on 84", 87", and 90" tall    \*Not available on 93" and 96" tall    \*Not available on 84" tall

**Construction Upgrades**

APC	ET	PE

**Door Options**

CG.TOP	DPSRR	MFO

OFFICE & FURNITURE CABINET NOMENCLATURE

MODIFICATIONS GRID KEY

W1830BC

Cabinet Type ← → Cabinet Width

- Available
- STD Standard on these cabinets
- 5 DAY** 5 Day Express Response Item

NOTE:  
All office cabinets are predrilled for full depth shelves or roll trays.

CUSTOM MODIFICATIONS

Mod.	Description	Mod.	Description	Mod.	Description
ADDTK	Add Toekick	EXBKR	End Extended Back - Right	PFINBTMB	Prepare Cabinet for Finished Bottom
AUTHB	Authentic Ends - Both	EXL	Extended Stile - Left		
AUTHL	Authentic End - Left	EXR	Extended Stile - Right	PTOWB	Push to Open Wastebasket
AUTHR	Authentic End - Right	FB	Finished Ends	RD	Reduced Depth
CBO	Cabinet Box Only	FFDL	Face Frame and Door on End - Left	RECTKALL	Recessed Island Toekick
CCO	Cabinet Case Only	FFDR	Face Frame and Door on End - Right	RECTKBK	Recessed Toekick - Back
CFNTO	Cabinet Front Only	FPEB	Furniture Finished Plywood Ends	RECTKL	Recessed Toekick - Left
CFP	Cabinet False Panel	FTK	Flush Toekick	RECTKR	Recessed Toekick - Right
CFRMO	Cabinet Frame Only	FTKAV	Flush Toekick Arch	RT	Installed Roll Tray
CND	Cabinet with No Door, with Drawer	FTKAV	Flush Toekick Furniture	TVRAV	Valance Top Rail, Arch
		ID	Increased Depth	TVRFV	Valance Top Rail, Furniture
DRWSEC	Biometric Secured Drawer	INVFRM	Inverted Frame	TVRVV	Valance Top Rail, Straight
DRWTK	Toekick Drawer	LTI	Light Installed Battery Strip	VTK	Void Toekick
EXBKL	End Extended Back - Left	MIP	Matching Interior Plywood	WLI	White Laminate Interior

CONSTRUCTION UPGRADES

Mod.	Description
APC	All-plywood Construction
PE	Plywood Ends

DOOR OPTIONS

Mod.	Description
DPSRR	Door Panel - Solid Reverse Raised

BOOKCASE, 30", 33", or 36" HIGH, 12" DEEP

18", 21", 24", 27", 30", 33", or 36"

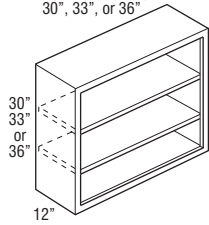

- W1830BC
- W2130BC
- W2430BC
- W2730BC
- W3030BC
- W3330BC
- W3630BC

- NEW** W1833BC
- NEW** W2133BC
- NEW** W2433BC
- NEW** W2733BC
- NEW** W3033BC
- NEW** W3333BC
- NEW** W3633BC
- NEW** W1836BC
- NEW** W2136BC
- NEW** W2436BC
- NEW** W2736BC
- NEW** W3036BC
- NEW** W3336BC
- NEW** W3636BC

- Matching Interior Plywood (MIP) standard.
- If ordered with Heirloom Technique, will not feature sand-through characteristics.
- To change the top rail valance, specify one of the following modifications: Arch (TVRAV), Furniture (TVRFV), or Straight Valance (TVRVV).

Custom Modifications

ADDTK	AUTH	CBO	CCO	CFNTO	CFP	CFRMO	CND	DRWSEC	DRWTK	EXBK	EX	FB	FFD	FPEB	FTK	FTK_V	ID	INVFRM	LTI	MIP	PFINBTMB	PTOWB	RD	RECTK_	RT	TVR_V	VTK	WLI
•	•								STD											STD								

Construction Upgrades

APC	PE
-----	----

Door Options

DPSRR
-------



**BOOKCASE, 39", 42", or 48" HIGH, 12" DEEP**

18", 21", 24", 27",  
30", 33", or 36"

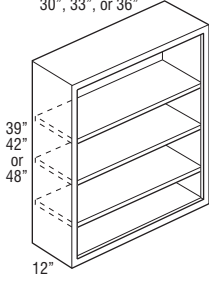

- NEW** W1839BC
- NEW** W2139BC
- NEW** W2439BC
- NEW** W2739BC
- NEW** W3039BC
- NEW** W3339BC
- NEW** W3639BC
- NEW** W1842BC
- NEW** W2142BC
- NEW** W2442BC
- NEW** W2742BC
- NEW** W3042BC
- NEW** W3342BC
- NEW** W3642BC

- W1848BC
- W2148BC
- W2448BC
- W2748BC
- W3048BC
- W3348BC
- W3648BC

- Matching Interior Plywood (MIP) standard.
- If ordered with Heirloom Technique, will not feature sand-through characteristics.
- To change the top rail valance, specify one of the following modifications: Arch (TVRAV), Furniture (TVRFV), or Straight Valance (TVRVV).

**Custom Modifications**

ADDTK	AUTH	CBO	CCO	CFNTO	CFP	CFRMO	CND	DRWSEC	DRWTK	EXBK	EX	FB	FFD	FPEB	FTK	FTK_V	ID	INVFRM	LTI	MIP	PFINBTMB	PTOWB	RD	RECTK	RT	TVR_V	VTK	WLI

**Construction Upgrades**

APC	PE

**Door Options**

DPSRR

**WALL FURNITURE BOOKCASE,  
48", 51", or 54" HIGH, 12" DEEP**

18", 21", 24", 27",  
30", 33", or 36"

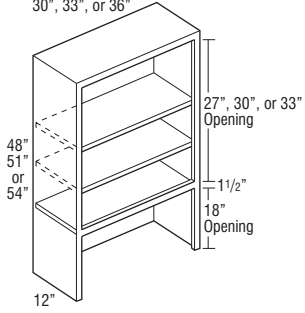

- WFBC1848
- WFBC2148
- WFBC2448
- WFBC2748
- WFBC3048
- WFBC3348
- WFBC3648
- WFBC1851
- WFBC2151
- WFBC2451
- WFBC2751
- WFBC3051
- WFBC3351
- WFBC3651
- WFBC1854
- WFBC2154
- WFBC2454
- WFBC2754
- WFBC3054
- WFBC3354
- WFBC3654

- 48", 51", and 54" have two adjustable shelves and one fixed shelf.
- Matching Interior Plywood (MIP) standard.
- If ordered with Heirloom Technique, will not feature sand-through characteristics.
- To change the top rail valance, specify one of the following modifications: Arch (TVRAV), Furniture (TVRFV), or Straight Valance (TVRVV).
- Bookcases can only be reduced to 9".

**Custom Modifications**

ADDTK	AUTH	CBO	CCO	CFNT0	CEP	CFRMO	CND	DRWSEC	DRWTK	EXBK	EX	FB	FFD	FPEB	FTK	FTK_V	ID	INVFRM	LTI	MIP	PFINBTMB	PTOWB	RD	RECTK_RT	TVR_V	VTK	WLI

**Construction Upgrades**

APC	PE

**Door Options**

DPSRR

**WALL FURNITURE BOOKCASE,  
57", 60", or 66" HIGH, 12" DEEP**

18", 21", 24", 27",  
30", 33", or 36"

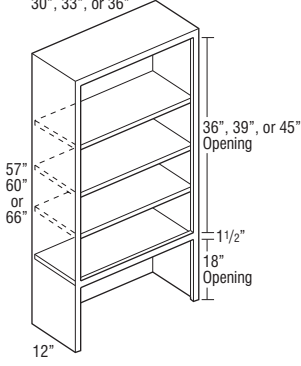

- WFBC1857
- WFBC2157
- WFBC2457
- WFBC2757
- WFBC3057
- WFBC3357
- WFBC3657
- WFBC1860
- WFBC2160
- WFBC2460
- WFBC2760
- WFBC3060
- WFBC3360
- WFBC3660
- WFBC1866
- WFBC2166
- WFBC2466
- WFBC2766
- WFBC3066
- WFBC3366
- WFBC3666

- 57", 60", and 66" have three adjustable shelves and one fixed shelf.
- Matching Interior Plywood (MIP) standard.
- If ordered with Heirlooming Technique, will not feature sand-through characteristics.
- To change the top rail valance, specify one of the following modifications: Arch (TVRAV), Furniture (TVRFV), or Straight Valance (TVRVV).
- Bookcases can only be reduced to 9".

**Custom Modifications**

ADDTK	AUTH	CBO	CCO	CFNTO	CFP	CFRMO	CND	DRWSEC	DRWTK	EXBK	EX	FB	FFD	FPEB	FTK	FTK_V	ID	INVFRM	LTI	MIP	PFINBTMB	PTOWB	RD	RECTK	RT	TVR_V	VTK	WLI
	•*	STD				•				•	•			•			•			STD			•			•		

\*Not available on 66" high

**Construction Upgrades**

APC	PE

**Door Options**

DPSRR

**TALL BOOKCASE, 84", 87", or 90" HIGH, 12" or 18" DEEP**

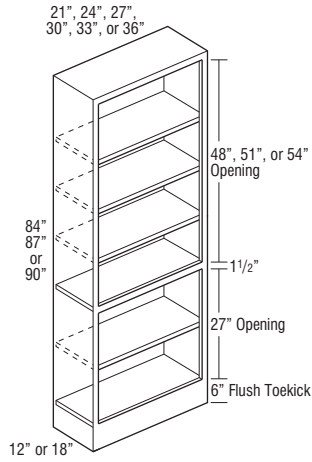

- TBC218412
- TBC248412
- TBC278412
- TBC308412
- TBC338412
- TBC368412
- TBC218418
- TBC248418
- TBC278418
- TBC308418
- TBC338418
- TBC368418
- TBC218712
- TBC248712
- TBC278712
- TBC308712
- TBC338712
- TBC368712
- TBC218718
- TBC248718
- TBC278718
- TBC308718
- TBC338718
- TBC368718
- TBC219012
- TBC249012
- TBC279012
- TBC309012
- TBC339012
- TBC369012
- TBC219018
- TBC249018
- TBC279018
- TBC309018
- TBC339018
- TBC369018

- 84" and 87" tall include four adjustable shelves and one fixed shelf.
- 90" tall includes five adjustable shelves and one fixed shelf.
- Matching Interior Plywood (MIP) standard.
- If ordered with Heirloom Technique, will not feature sand-through characteristics.
- To change the top rail valance, specify one of the following modifications: Arch (TVRAV), Furniture (TVRFV), or Straight Valance (TVRVV).
- Bookcases can only be reduced to 9".

**Custom Modifications**

ADDTK	AUTH	CBO	CCO	CFNTO	CFP	CFRMO	CND	DRWSEC	DRWTK	EXBK	EX	FB	FFD	FPEB	FTK	FTK_V	ID	INVRM	LTI	MIP	PFINBTMB	PTOWB	RD	RECTK_RT	TVR_V	VTK	WLI

**Construction Upgrades**

APC	PE

**Door Options**

DPSRR

**TALL BOOKCASE, 93" or 96" HIGH,  
12" or 18" DEEP**

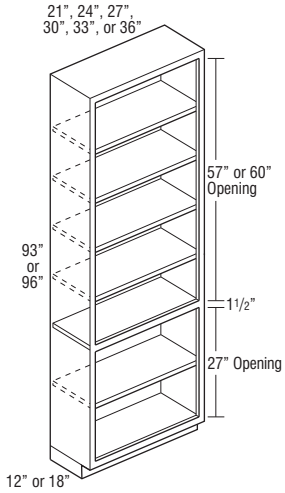

- TBC219312
- TBC249312
- TBC279312
- TBC309312
- TBC339312
- TBC369312
- TBC219318
- TBC249318
- TBC279318
- TBC309318
- TBC339318
- TBC369318
- TBC219612
- TBC249612
- TBC279612
- TBC309612
- TBC339612
- TBC369612
- TBC219618
- TBC249618
- TBC279618
- TBC309618
- TBC339618
- TBC369618

- 93" tall includes five adjustable shelves and one fixed shelf.
- 96" tall includes six adjustable shelves and one fixed shelf.
- Separate pedestal base included but packaged separately on 93" and 96" tall. Pedestals are the same width as the cabinet box except when specified with FPED, in which the pedestal will be 1/4" recessed when centered.
- Matching Interior Plywood (MIP) standard.
- If ordered with Heirloom Technique, will not feature sand-through characteristics.
- To change the top rail valance, specify one of the following modifications: Arch (TVRAV), Furniture (TVRFV), or Straight Valance (TVRVV).
- Bookcases can only be reduced to 9".

**Custom Modifications**

ADDTK	AUTH	CBO	CCO	CFNTO	CFP	CFRMO	CND	DRWSEC	DRWTK	EXBK	EX	FB	FFD	FPEB	FTK	FTK_V	ID	INVERM	LTI	MIP	PFINBTMB	PTOWB	RD	RECTK	RT	TVR_V	VTK	WLI
		STD																										

**Construction Upgrades**

APC	PE

**Door Options**

DPSRR

**TALL BOOKCASE with DOORS, 84", 87", or 90" HIGH, 12" or 18" DEEP**

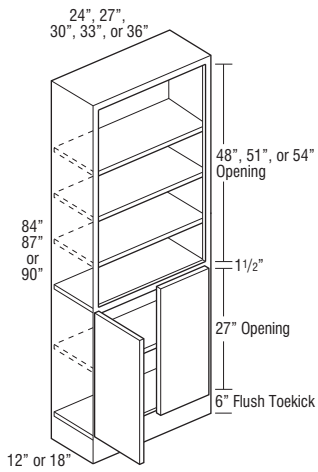
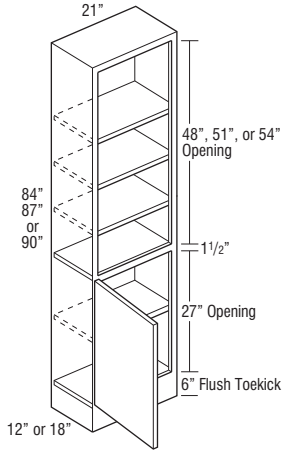

- TBCD218412 L or R
- TBCD218418 L or R
- TBCD218712 L or R
- TBCD218718 L or R
- TBCD219012 L or R
- TBCD219018 L or R

- TBCD248412
- TBCD278412
- TBCD308412
- TBCD338412
- TBCD368412
- TBCD248418
- TBCD278418
- TBCD308418
- TBCD338418
- TBCD368418
- TBCD248712
- TBCD278712
- TBCD308712
- TBCD338712
- TBCD368712
- TBCD248718
- TBCD278718
- TBCD308718
- TBCD338718
- TBCD368718
- TBCD249012
- TBCD279012
- TBCD309012
- TBCD339012
- TBCD369012
- TBCD249018
- TBCD279018
- TBCD309018
- TBCD339018
- TBCD369018

- 84" and 87" tall include four adjustable shelves and one fixed shelf.
- 90" tall includes five adjustable shelves and one fixed shelf.
- Matching Interior Plywood (MIP) standard.
- Top of doors match to a standard, full height base door, 34 1/2" high.
- To change the top rail valance, specify one of the following modifications: Arch (TVRAV), Furniture (TVRFV), or Straight Valance (TVRVV).
- Bookcases can only be reduced to 9".

**Custom Modifications**

ADDTK	AUTH	CBO	CCO	CFNTO	CFP	CFRMO	CND	DRWSEC	DRWTK	EXBK	EX	FB	FFD	FPEB	FTK	FTK_V	ID	INVFRM	LTI	MIP	PFINBTMB	PTOWB	RD	RECTK	RT	TVR_V	VTK	WLL
			•	•		•				•	•			•	STD	•	•				STD			•			•	

**Construction Upgrades**

APC	PE

**Door Options**

DPSRR
•

**TALL BOOKCASE with DOORS,  
93" or 96" HIGH, 12" or 18" DEEP**

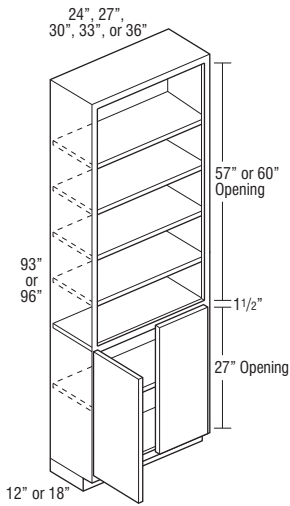
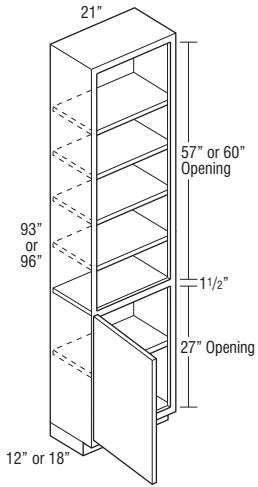

TBCD219312 L or R  
TBCD219318 L or R  
TBCD219612 L or R  
TBCD219618 L or R

TBCD249312  
TBCD279312  
TBCD309312  
TBCD339312  
TBCD369312  
TBCD249318  
TBCD279318  
TBCD309318  
TBCD339318  
TBCD369318  
TBCD249612  
TBCD279612  
TBCD309612  
TBCD339612  
TBCD369612  
TBCD249618  
TBCD279618  
TBCD309618  
TBCD339618  
TBCD369618

- 93" tall includes five adjustable shelves and one fixed shelf.
- 96" tall includes six adjustable shelves and one fixed shelf.
- Separate pedestal base included but packaged separately on 93" and 96" tall. Pedestals are the same width as the cabinet box except when specified with FPEB, in which the pedestal will be 1/4" recessed when centered.
- Matching Interior Plywood (MIP) standard.
- Top of doors match to a standard, full height base door, 34 1/2" high.
- To change the top rail valance, specify one of the following modifications: Arch (TVRAV), Furniture (TVRFV), or Straight Valance (TVRVV).
- Bookcases can only be reduced to 9".

**Custom Modifications**

ADDTK	AUTH	CBO	CCO	CFWTO	CFP	CFRMO	CND	DRWSEC	DRWTK	EXBK	EX	FB	FFD	FPEB	FTK	FTK_V	ID	INVFRM	LTI	MIP	PFINBTMB	PTOWB	RD	RECTK	RT	TVR_V	VTK	WLI
			•	•	•					•	•			•	•	•	•				STD		•			•		

**Construction Upgrades**

APC	PE

**Door Options**

DPSRR
•

**DESK DOOR DRAWER BASE,  
29" HIGH, 21" or 24" DEEP**

12", 15", 18", or 21"

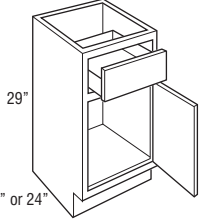

21" or 24"

24", 27", 30", 33", or 36"

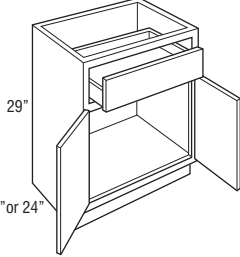

21" or 24"

- DD0122921 L or R
- DD0152921 L or R
- DD0182921 L or R
- DD0212921 L or R
- DD0122924 L or R
- DD0152924 L or R
- DD0182924 L or R
- DD0212924 L or R

- DD0242921
- DD0272921
- DD0302921
- DD0332921
- DD0362921
- DD0242924
- DD0272924
- DD0302924
- DD0332924
- DD0362924

- Depth can be reduced to a minimum of 12".
- Depth can be increased to a maximum of 24".

**Custom Modifications**

ADDTK	AUTH	CBO	CCO	CFNTO	CFP	CFRMO	CND	DRWSEC	DRWTK	EXBK	EX	FB	FFD	FPEB	FTK	FTK_V	ID	INVFRM	LTI	MIP	PFINBTMB	PTOWB	RD	RECTK_	RT	TVR_V	VTK	WLI
•*	•	•	•	•	•	•	•	•*	•▲	•	•	•	•	•	•	•i	•f	•	•†	•			•	•	•	•	•	•

\*Not available on 21" deep    \*Available only on 18", 21", and 24" wide    ▲Not available on 12" and 15" wide    †Not available on 12" wide    ‡Not available on 24" deep

**Construction Upgrades**

APC	PE
•	•

**Door Options**

DPSRR
•



**DESK THREE DRAWER BASE, 29" HIGH, 21" or 24" DEEP**

12", 15", 18", 21", 24", 27", 30", 33", or 36"

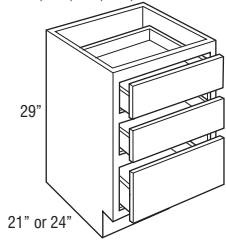

- 3DB122921
- 3DB152921
- 3DB182921
- 3DB212921
- 3DB242921
- 3DB272921
- 3DB302921
- 3DB332921
- 3DB362921
- 3DB122924
- 3DB152924
- 3DB182924
- 3DB212924
- 3DB242924
- 3DB272924
- 3DB302924
- 3DB332924
- 3DB362924

- Depth can be reduced to a minimum of 12".
- Depth can be increased to a maximum of 24".

**Custom Modifications**

ADDTK	AUTH	CBO	CCO	CFNTO	CFP	CFRMO	CND	DRWSEC	DRWTK	EXBK	EX	FB	FFD	FPEB	FTK	FTK_V	ID	INVFRM	LTI	MIP	PFINBTMB	PTOWB	RD	RECTK	RT	TVR_V	VTK	WU
	•*	•	•		•	•		•+	•▲	•	•	•	•	•	•	•†							•	•				•

\*Not available on 21" deep    \*Available only on 18", 21", and 24" wide, 24" deep    †Not available on 12" and 15" wide    †Not available on 12" wide

**Construction Upgrades**

APC	PE
•	•

**Door Options**

DPSRR

**DESK FILE DRAWER BASE, 29" HIGH, 21" or 24" DEEP**

15", 18", or 21"

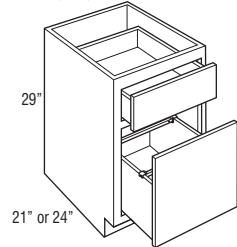

- DFD152921
- DFD182921
- DFD212921
- DFD152924
- DFD182924
- DFD212924

- Door is attached to file drawer.
- Includes Filing System Hardware Kit, which accommodates letter and legal filing.
- Exterior height of file drawer is 10".

**Custom Modifications**

ADDTK	AUTH	CBO	CCO	CFNTO	CFP	CFRMO	CND	DRWSEC	DRWTK	EXBK	EX	FB	FFD	FPEB	FTK	FTK_V	ID	INVFRM	LTI	MIP	PFINBTMB	PTOWB	RD	RECTK	RT	TVR_V	VTK	WU
	•*	•	•		•	•		•+	•▲	•	•	•	•	•	•	•								•	•			•

\*Not available on 21" deep    \*Available only on 18" and 21" wide, 24" deep    †Not available on 15" wide

**Construction Upgrades**

APC	PE
•	•

**Door Options**

DPSRR

**DESK DOUBLE FILE DRAWER BASE,  
29" HIGH, 21" or 24" DEEP**

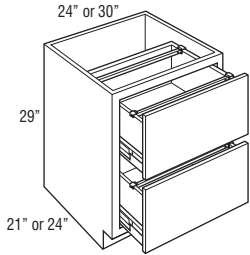

- DDFD242921
- DDFD302921
- DDFD242924
- DDFD302924

- Includes Filing System Hardware Kit, which accommodates letter and legal filing.
- Drawers utilize 125 lb. full extension progressive side-mount guide, does not feature soft-close guide.
- Bottom of drawer is not designed to support any weight.
- Exterior height of drawer box is 9 1/2".

**Custom Modifications**

ADDTK	AUTH	CBO	CCO	CFNTO	CFP	CFRMO	CND	DRWSEC	DRWTK	EXBK	EX	FB	FFD	FPEB	FTK	FTK_V	ID	INVFRM	LTI	MIP	PFINBTMB	PTOWB	RD	RECTK	RT	TVR_V	VTK	WLI
	•*	•	•			•			•	•	•		•	•	•	•								•				•

\*Not available on 21" deep

**Construction Upgrades**

APC	PE
•	•

**Door Options**

DPSRR

**DESK WASTEBASKET FULL HEIGHT  
BASE, 29" HIGH, 15" or 18" WIDE,  
21" or 24" DEEP**

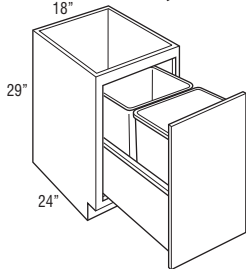
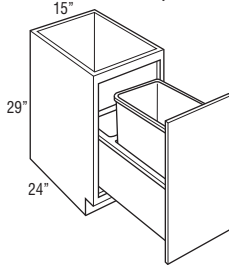
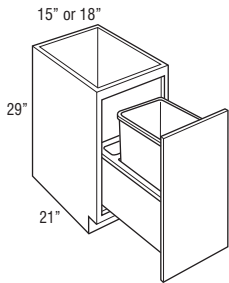

- DWB152921FH
- DWB182921FH
- DWB152924FH

**DWB182924FH**

- Pull-out features undermount smart close guides.
- DWB152921FH, DWB182921FH, and DWB152924FH include one 35 quart gray wastebasket and a trash bag storage area.
- DWB182924FH includes two 35 quart gray wastebaskets.
- Base Wastebasket Lid (BWBLID) fits 35 quart wastebaskets. On DWB182924FH, BWBLID can only be used on the front wastebasket. See page 370.

**Custom Modifications**

ADDTK	AUTH	CBO	CCO	CFNTO	CFP	CFRMO	CND	DRWSEC	DRWTK	EXBK	EX	FB	FFD	FPEB	FTK	FTK_V	ID	INVFRM	LTI	MIP	PFINBTMB	PTOWB	RD	RECTK	RT	TVR_V	VTK	WLI
	•*	•	•			•			•*	•	•		•	•	•	•					•		•*		•			•

\*Not available on 21" deep

\*Not available on 15" wide

**Construction Upgrades**

APC	PE
•	•

**Door Options**

DPSRR
•

**DESK EASY REACH, 29" HIGH,  
21" or 24" DEEP**

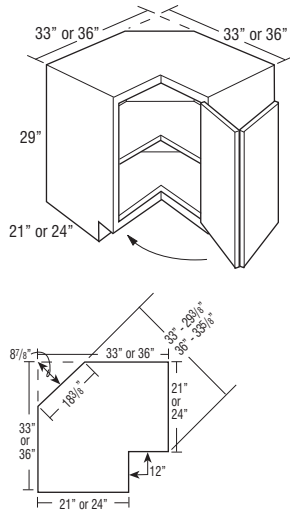

**DER33321 L or R  
DER36324 L or R**

- Features one fixed shelf in center of cabinet.
- Decorative hardware screws must be countersunk to prevent scratching of adjacent cabinets and face frame of DER.
- DER33321 L or R wall width is 33" x 33".
- DER36324 L or R wall width is 36" x 36".
- Integrated soft-close hinge not included.

**Custom Modifications**

ADDTK	AUTH	CBO	CCO	CFNTO	CFP	CFRMO	CND	DRWSEC	DRWTK	EXBK	EX	FB	FFD	FPEB	FTK	FTK_V	ID	INVFRM	LTI	MIP	PFINBTMB	PTOWB	RD	RECTK_	RT	TVR_V	VTK	WU	
			•	•									•	•						•	•				•			•	•

**Construction Upgrades**

APC	PE
•	•

**Door Options**

DPSRR
•

**FURNITURE DRAWER, 6 3/4" HIGH,  
24" DEEP**

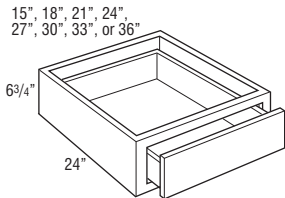

- FD1506.7524  
FD1806.7524  
FD2106.7524  
FD2406.7524  
FD2706.7524  
FD3006.7524  
FD3306.7524  
FD3606.7524**

- Exterior height of drawer box is 3 3/8".

**Custom Modifications**

ADDTK	AUTH	CBO	CCO	CFNTO	CFP	CFRMO	CND	DRWSEC	DRWTK	EXBK	EX	FB	FFD	FPEB	FTK	FTK_V	ID	INVFRM	LTI	MIP	PFINBTMB	PTOWB	RD	RECTK_	RT	TVR_V	VTK	WU
•			•	•			•			•	•	•		•										•				

**Construction Upgrades**

APC	PE
•	•

**Door Options**

DPSRR

**FURNITURE DRAWER, 12" HIGH,  
24" DEEP**

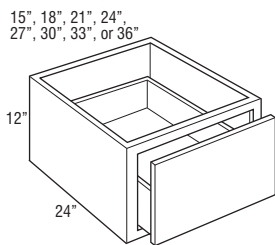

- FD151224  
FD181224  
FD211224  
FD241224  
FD271224  
FD301224  
FD331224  
FD361224**

- Drawer front to face frame reveal is justified to the bottom. Top reveal is 3/8" and bottom reveal is 1/4".
- Exterior height of drawer box is 6 3/8".

**Custom Modifications**

ADDTK	AUTH	CBO	CCO	CFNTO	CFP	CFRMO	CND	DRWSEC	DRWTK	EXBK	EX	FB	FFD	FPEB	FTK	FTK_V	ID	INVFRM	LTI	MIP	PFINBTMB	PTOWB	RD	RECTK_	RT	TVR_V	VTK	WU
•			•	•			•			•	•	•		•										•				

**Construction Upgrades**

APC	PE
•	•

**Door Options**

DPSRR

**FURNITURE DRAWER WINDOW BENCH, 18" HIGH, 24" DEEP**

15", 18", 21", 24", 27", 30", 33", or 36"

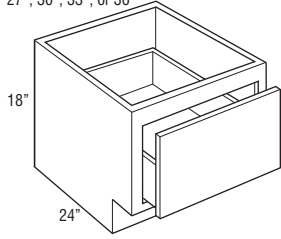

- FDWB151824
- FDWB181824
- FDWB211824
- FDWB241824
- FDWB271824
- FDWB301824
- FDWB331824
- FDWB361824

- Drawer front to face frame reveal is justified to the bottom. Top reveal is 1 7/8" and bottom reveal is 1/4".
- Exterior height of drawer box is 6 3/8".

**Custom Modifications**

ADDTK	AUTH	CBO	CCO	CFNTO	CFP	CFRMO	CND	DRWSEC	DRWTK	EXBK	EX	FB	FFD	FPEB	FTK	FTK_V	ID	INVFRM	LTI	MIP	PFINBTMB	PTOWB	RD	RECTK	RT	TVR_V	VTK	WLI
			•	•					•*	•	•	•		•	•	•							•	•				•

\*Not available on 15" wide

**Construction Upgrades**

APC	PE
•	•

**Door Options**

DPSRR

**WOOD TOPS, ONE SIDED, 22 1/2" or 25 1/2" DEEP**

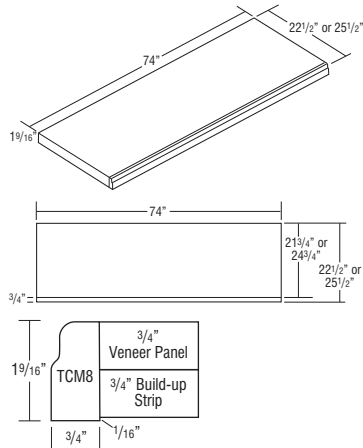

- 1TWT7221
- 1TWT7224

- 3/4" thick veneer over MDF panels with build-up strips to 1 1/2" thick and Traditional Countertop Moulding (TCM8) on front edge.

**MODIFICATIONS**

No modifications available for these products.

**Construction Upgrades**

APC	PE
•	

**Finish Techniques**

Distressing	Heirlooming
	•

**WOOD TOPS, THREE SIDED,  
22 1/2" or 25 1/2" DEEP**

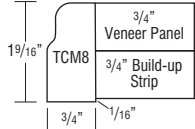
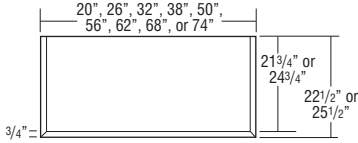
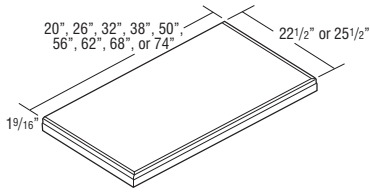

Model	Overall Width	Overall Depth
3TWT1821	20"	22 1/2"
3TWT2421	26"	22 1/2"
3TWT3021	32"	22 1/2"
3TWT3621	38"	22 1/2"
3TWT4821	50"	22 1/2"
3TWT5421	56"	22 1/2"
3TWT6021	62"	22 1/2"
3TWT6621	68"	22 1/2"
3TWT7221	74"	22 1/2"
3TWT1824	20"	25 1/2"
3TWT2424	26"	25 1/2"
3TWT3024	32"	25 1/2"
3TWT3624	38"	25 1/2"
3TWT4824	50"	25 1/2"
3TWT5424	56"	25 1/2"
3TWT6024	62"	25 1/2"
3TWT6624	68"	25 1/2"
3TWT7224	74"	25 1/2"

- 3TWT1821
- 3TWT2421
- 3TWT3021
- 3TWT3621
- 3TWT4821
- 3TWT5421
- 3TWT6021
- 3TWT6621
- 3TWT7221
- 3TWT1824
- 3TWT2424
- 3TWT3024
- 3TWT3624
- 3TWT4824
- 3TWT5424
- 3TWT6024
- 3TWT6624
- 3TWT7224

• 3/4" thick veneer over MDF panels with build-up strips to 1 1/2" thick and Traditional Countertop Moulding (TCM8) on front and side edges.

MODIFICATIONS
No modifications available for these products.

**Construction Upgrades**

APC	PE
•	

**Finish Techniques**

Distressing	Heirlooming
	•

**WOOD TOPS, FOUR SIDED,  
27" or 33" DEEP**

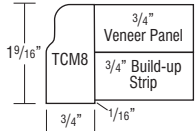
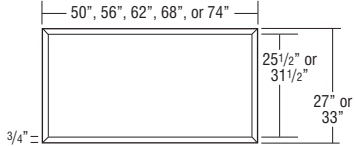
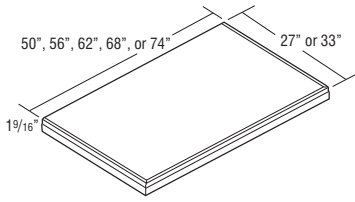

Model	Overall Width	Overall Depth
4TWT4827	50"	27"
4TWT5427	56"	27"
4TWT6027	62"	27"
4TWT6627	68"	27"
4TWT7227	74"	27"
4TWT4833	50"	33"
4TWT5433	56"	33"
4TWT6033	62"	33"
4TWT6633	68"	33"
4TWT7233	74"	33"

- 4TWT4827
- 4TWT5427
- 4TWT6027
- 4TWT6627
- 4TWT7227
- 4TWT4833
- 4TWT5433
- 4TWT6033
- 4TWT6633
- 4TWT7233

• 3/4" thick veneer over MDF panels with build-up strips to 1 1/2" thick and Traditional Countertop Moulding (TCM8) on front, back, and side edges.

MODIFICATIONS	
No modifications available for these products.	

Construction Upgrades	
APC	PE
•	

Finish Techniques	
Distressing	Heirlooming
	•

**UNDER COUNTER DRAWER,  
4 3/4" HIGH, 21" DEEP**

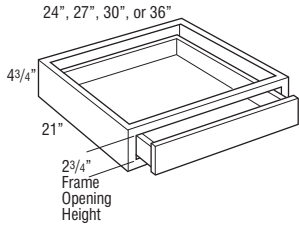

- UCD2421
- UCD2721
- UCDS3021
- UCDS3621

- Cabinet is 4 3/4" high. Drawer box within cabinet is 2" high (outside dimension).
- Not trimmable.
- Drawer front is 3/4" slab front.
- The frame to end panel offset is 3/4", which is designed to accommodate the vanity desk leg.
- End panels ordered in Standard construction will feature non-matching laminate exterior. When ordered in PE or APC, end panels will not be finished.
- Reduced depth is available in 3" increments.

ADDTK	AUTH	CBO	CCO	CFNT0	CFP	CFRMO	CND	DRWSEC	DRWTK	EXBK	EX	FB	FFD	FPEB	FTK	FTK_V	ID	INVFRM	LTI	MIP	PFINBTMB	PTOWB	RD	RECTK	RT	TVR_V	VTK	WLI
			•	•																								

Construction Upgrades	
APC	PE
•	•

Door Options
DPSRR

**NEW UNDER COUNTER DRAWER  
TRIMMABLE, 4 3/4" HIGH,  
21" DEEP**

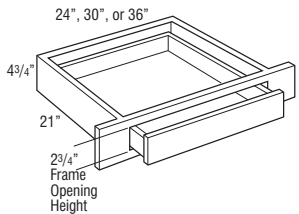

- UCDT2421
- UCDT3021
- UCDT3621

- Cabinet is 4 3/4" high. Drawer box within cabinet is 2" high (outside dimension).
- Frame stile is trimmable 3" on each side.
- Drawer front is 3/4" slab front.
- The frame to end panel offset is 3/4", which is designed to accommodate the vanity desk leg.
- End panels ordered in Standard construction will feature non-matching laminate exterior. When ordered in PE or APC, end panels will not be finished.
- Reduced depth is available in 3" increments.

ADDTK	AUTH	CBO	CCO	CFNT0	CFP	CFRMO	CND	DRWSEC	DRWTK	EXBK	EX	FB	FFD	FPEB	FTK	FTK_V	ID	INVFRM	LTI	MIP	PFINBTMB	PTOWB	RD	RECTK	RT	TVR_V	VTK	WLI
			•	•																								

Construction Upgrades	
APC	PE
•	•

Door Options
DPSRR

VANITY CABINET NOMENCLATURE

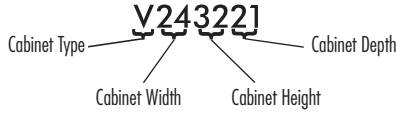

**NOTE:**  
Distance between back of drawer box and back interior of cabinet is 2 3/4".  
All vanity cabinets are predrilled for full depth shelves or roll trays.

TOEKICKS

Vanity Cabinets are shipped with an unfinished toekick. Finished toekicks in matching wood veneer or laminate must be ordered separately and field installed.

MODIFICATIONS GRID KEY

- Available
- STD Standard on these cabinets
- 5 DAY** 5 Day Express Response Item

CUSTOM MODIFICATIONS				CONSTRUCTION UPGRADES		DOOR OPTIONS	
Mod.	Description	Mod.	Description	Mod.	Description	Mod.	Description
AUTHB	Authentic Ends - Both	EXBKL	End Extended Back - Left	INVFRM	Inverted Frame	ALF	Aluminum Frame Doors
AUTHL	Authentic End - Left	EXBKR	End Extended Back - Right	LTI	Light Installed Battery Strip	CG	Cut-for-glass Doors
AUTHR	Authentic End - Right	EXL	Extended Stile - Left	MIP	Matching Interior Plywood	DPSRR	Door Panel - Solid Reverse Raised
CBO	Cabinet Box Only	EXR	Extended Stile - Right	RD	Reduced Depth	MD	Mullion Doors
CCO	Cabinet Case Only	FB	Finished Ends	RECTKALL	Recessed Island Toekick	MFO	Modified Full Overlay
CFNTO	Cabinet Front Only	FFDL	Face Frame and Door on End - Left	RECTKBK	Recessed Toekick - Back		
CFP	Cabinet False Panel			RECTKL	Recessed Toekick - Left		
CFRMO	Cabinet Frame Only	FFDR	Face Frame and Door on End - Right	RECTKR	Recessed Toekick - Right		
CMAT	CabMat™			RT	Installed Roll Tray		
CND	Cabinet with No Door, with Drawer	FPEB	Furniture Finished Plywood Ends	TKP	Loose Toekick		
DRWPWR	PowerGlide™ Compact Drawer Outlet	FTK	Flush Toekick	TOTSSS	Tilt-out Tray, Stainless Steel Slim		
DRWTK	Toekick Drawer	FTKAV	Flush Toekick Arch	VTK	Void Toekick		
		FTKRV	Flush Toekick Furniture	WLI	White Laminate Interior		
		ID	Increased Depth				

**VANITY BASE, 32" HIGH, 21" DEEP**

12", 15", 18", 21", or 24"

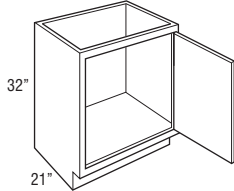

- V123221 L or R
- V153221 L or R
- V183221 L or R
- V213221 L or R
- V243221 L or R

24", 27", 30", 33", or 36"

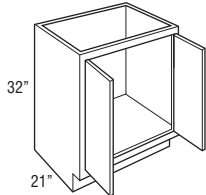

- V243221
- V273221
- V303221
- V333221
- V363221

39", 42", 45", or 48"

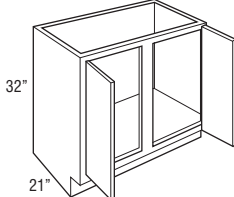

- V393221
- V423221
- V453221
- V483221CS

48" or 60"

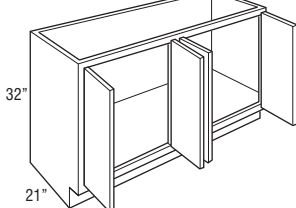

- V483221
- V603221

Custom Modifications

AUTH	CBO	CCO	CFNTO	CFP	CFRMO	CMAT	CND	DRWPWR	DRWTK	EXBK	EX	FB	FFD	FPEB	FTK	FTK_V	ID	INVFRM	LTI	MIP	RD	RECTK_	RT	TKP	TOTSSS	VTK	WLI	
•	•	•	•	•	•	•*	•	•	•*	•	•	•	•	•	•	•▲	•	•	•▲	•	•	•	•	•	•	•	•	•

\*Not available on 12", 15", 18", 21", 39", 42", and 45" wide \*Not available on 12", 15", 39", 42", 45", 48", and 60" wide ▲Not available on 12" wide

Construction Upgrades

APC	PE
•	•

Door Options

ALF	CG	DPSRR	MD	MFO
		•		

**VANITY BASE, 34 1/2" HIGH, 21" DEEP**

12", 15", 18", 21", or 24"

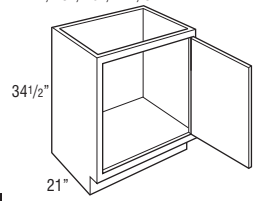

24", 27", 30", 33", or 36"

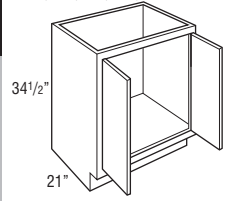

39", 42", 45", or 48"

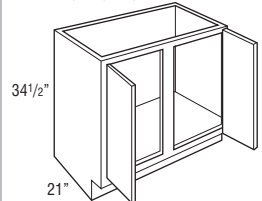

48" or 60"

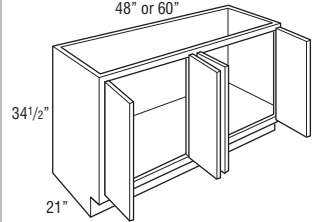

- V123421 L or R
- V153421 L or R
- V183421 L or R
- V213421 L or R
- V243421 L or R

- V243421
- V273421
- V303421
- V333421
- V363421

- V393421
- V423421
- V453421
- V483421CS

- V483421
- V603421

**Custom Modifications**

AUTH	CBO	CCO	CFNTO	CFP	CFRMO	CMAT	CND	DRWPWR	DRWTK	EXBK	EX	FB	FFD	FPEB	FTK	FTK_V	ID	INVFRM	LTI	MIP	RD	RECTK	RT	TKP	TOTSSS	VTK	WLI
•	•	•	•	•	•	•*			•*	•	•	•	•	•	•	•▲	•		•▲	•	•	•	•	•	•	•	•

\*Not available on 12", 15", 18", 21", 39", 42", and 45" wide    \*Not available on 12", 15", 39", 42", 45", 48" and 60" wide    ▲Not available on 12" wide

**Construction Upgrades**

APC	PE
•	•

**Door Options**

ALF	CG	DPSRR	MD	MFO
		•		



**VANITY SINK BASE with FALSE PANEL, 32" HIGH, 21" DEEP**

15", 18", 21", or 24"

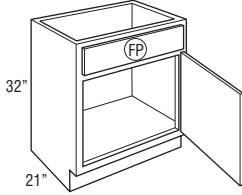

24", 27", 30", 33", or 36"

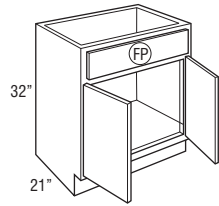

39", 42", 45", or 48"

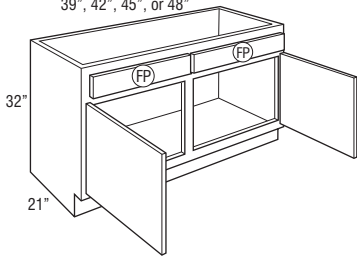

48", 54", or 60"

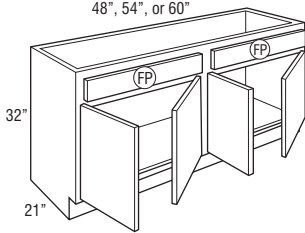

Ⓢ = False Panel

- VSB153221 L or R
- VSB183221 L or R
- VSB213221 L or R
- VSB243221 L or R

- VSB243221
- VSB273221
- VSB303221
- VSB333221
- VSB363221

- VSB393221
- VSB423221
- VSB453221
- VSB483221CS

- VSB483221
- VSB543221
- VSB603221

**Custom Modifications**

AUTH	CBO	CCO	CFNTO	CFP	CFRMO	CMAT	CND	DRWPWR	DRWTK	EXBK	EX	FB	FFD	FPEB	FTK	FTK_V	ID	INVFRM	LTI	MIP	RD	RECTK_	RT	TKP	TOTSSS	VTK	WLI
•				•	•	•*	•		•*	•	•	•	•	•	•	•	•	•	•	•	•	•	•	•	•	•	•

\*Not available on 15", 18", 21", 39", 42", and 45" wide    \*Not available on 15", 39", 42", 48", 54", and 60" wide

**Construction Upgrades**

APC	PE
•	•

**Door Options**

ALF	CG	DPSRR	MD	MFO
		•		

**VANITY SINK BASE with FALSE PANEL, 34 1/2" HIGH, 21" DEEP**

15", 18", 21", or 24"

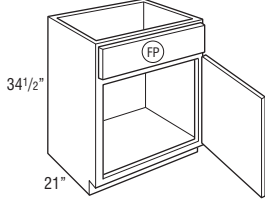

24", 27", 30", 33", or 36"

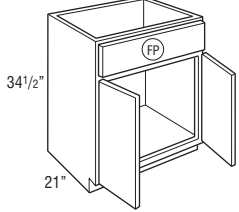

39", 42", 45", or 48"

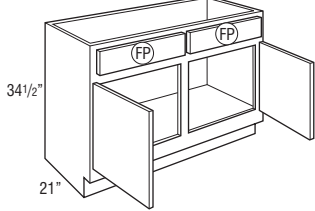

48", 54", or 60"

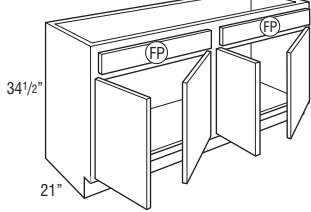

FP = False Panel

- VSB153421 L or R
- VSB183421 L or R
- VSB213421 L or R
- VSB243421 L or R

- VSB243421
- VSB273421
- VSB303421
- VSB333421
- VSB363421

- VSB393421
- VSB423421
- VSB453421
- VSB483421CS

- VSB483421
- VSB543421
- VSB603421

**Custom Modifications**

AUTH	CBO	CCO	CFNTO	CFP	CFRMO	CMAT	CND	DRWPWR	DRWTK	EXBK	EX	FB	FFD	FPEB	FTK	FTK_V	ID	INVFRM	LTI	MIP	RD	RECTK	RT	TKP	TOTSSS	VTK	WLI
•	•	•	•	STD	•	•*	•		•*	•	•	•	•	•	•	•	•	•	•	•	•	•	•	•	•	•	•

\*Not available on 15", 18", 21", 39", 42", and 45" wide    \*Not available on 15", 39", 42", 48", 54", and 60" wide

**Construction Upgrades**

APC	PE
•	•

**Door Options**

ALF	CG	DPSRR	MD	MFO
		•		

**VANITY SINK BASE with U-SHAPED PULL-OUT TRAYS, 32" HIGH, 21" DEEP**

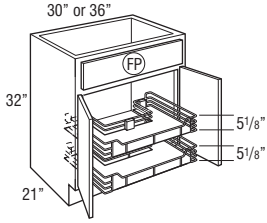

**VSB303221U  
VSB363221U**

- Includes two chrome U-shaped smart close pull-outs with gray shelf liner.
- VSB303221U Bottom pull-out is 25 1/4" wide and 17" deep. Cut-out for U-shape is 6 1/8" from back of cabinet and 15 3/4" wide. Top pull-out is 25 1/4" wide and 17" deep. Cut-out for U-shape is 12 1/8" from back of cabinet and 15 3/4" wide.
- VSB363221U Bottom pull-out is 31 1/4" wide and 17" deep. Cut-out for U-shape is 6 1/8" from back of cabinet and 15 3/4" wide. Top pull-out is 31 1/4" wide and 17" deep. Cut-out for U-shape is 12 1/8" from back of cabinet and 15 3/4" wide.

**Custom Modifications**

AUTH	CBO	CCO	CFNTO	CFP	CFRMO	CMAT	CND	DRWPWR	DRWTK	EXBK	EX	FB	FFD	FPEB	FTK	FTK_V	ID	INVFRM	LTI	MIP	RD	RECTK_	RT	TKP	TOTSSS	VTK	WLI
•	•	•	•	•	STD	•	•	•	•	•	•	•	•	•	•	•	•	•	•	•	•	•	•	•	•	•	•

**Construction Upgrades**

APC	PE
•	•

**Door Options**

ALF	CG	DPSRR	MD	MFO
		•		

**VANITY SINK BASE with U-SHAPED PULL-OUT TRAYS, 34 1/2" HIGH, 21" DEEP**

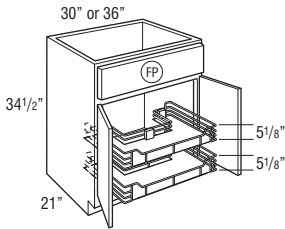

**VSB303421U  
VSB363421U**

- Includes two chrome U-shaped smart close pull-outs with gray shelf liner.
- VSB303421U Bottom pull-out is 25 1/4" wide and 17" deep. Cut-out for U-shape is 6 1/8" from back of cabinet and 15 3/4" wide. Top pull-out is 25 1/4" wide and 17" deep. Cut-out for U-shape is 12 1/8" from back of cabinet and 15 3/4" wide.
- VSB363421U Bottom pull-out is 31 1/4" wide and 17" deep. Cut-out for U-shape is 6 1/8" from back of cabinet and 15 3/4" wide. Top pull-out is 31 1/4" wide and 17" deep. Cut-out for U-shape is 12 1/8" from back of cabinet and 15 3/4" wide.

**Custom Modifications**

AUTH	CBO	CCO	CFNTO	CFP	CFRMO	CMAT	CND	DRWPWR	DRWTK	EXBK	EX	FB	FFD	FPEB	FTK	FTK_V	ID	INVFRM	LTI	MIP	RD	RECTK_	RT	TKP	TOTSSS	VTK	WLI
•	•	•	•	•	STD	•	•	•	•	•	•	•	•	•	•	•	•	•	•	•	•	•	•	•	•	•	•

**Construction Upgrades**

APC	PE
•	•

**Door Options**

ALF	CG	DPSRR	MD	MFO
		•		

**VANITY SINK BASE with WASTEBASKET, 34 1/2" HIGH, 21" DEEP**

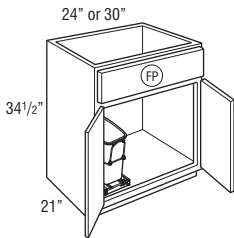

**VSB243421WB L or R  
VSB303421WB L or R**

- Bottom mounted zinc colored smart close guides with 20 quart gray wastebasket inserted in chrome support. Dimensions of unit: 8 37/64"W x 16 39/64"H x 17 3/4"D.
- L or R designates wastebasket location.

**Custom Modifications**

AUTH	CBO	CCO	CFNTO	CFP	CFRMO	CMAT	CND	DRWPWR	DRWTK	EXBK	EX	FB	FFD	FPEB	FTK	FTK_V	ID	INVFRM	LTI	MIP	RD	RECTK_	RT	TKP	TOTSSS	VTK	WLI
•	•	•	•	•	STD	•	•	•	•	•	•	•	•	•	•	•	•	•	•	•	•	•	•	•	•	•	•

**Construction Upgrades**

APC	PE
•	•

**Door Options**

ALF	CG	DPSRR	MD	MFO
		•		

**VANITY SINK BASE SUPERCABINET™ with TILT-OUT TRAYS and WASTEBASKET, 34 1/2" HIGH, 21" DEEP**

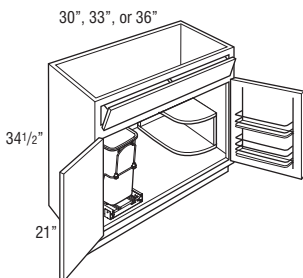

**VSSB303421STWB L or R  
VSSB333421STWB L or R  
VSSB363421STWB L or R**

- Quarter Round Reversible Shelf for left or right applications will be constructed from 3/4" thick laminated furniture board. (Shelf shipped secure, can be positioned in left or right corner.)
- Door on the side with the Quarter Round Shelf features a chrome and wood two-tiered rack.
- Door rack width is 11 3/8" on 30" and 33" wide cabinets and 14 3/8" on 36" wide cabinet.
- Door rack depth is 3 1/2".
- Includes 2 installed tilt-out trays.
- Tilt-out trays are stain resistant, moisture resistant plastic to allow storage of sponges & other cleaning materials.
- Tilt-out trays are also available as an accessory for field installation. See page 375.
- All load bearing surfaces meet KCMA standards of 15 lbs. per square foot.
- Bottom mounted zinc colored smart close guides with 20 quart gray wastebasket inserted in chrome support. Dimensions of unit: 8 37/64"W x 16 39/64"H x 17 3/4"D.
- L or R designates wastebasket location.

**Custom Modifications**

AUTH	CBO	CCO	CFNTO	CFP	CFRMO	CMAT	CND	DRWPWR	DRWTK	EXBK	EX	FB	FFD	FPEB	FTK	FTK_V	ID	INVFRM	LTI	MIP	RD	RECTK_	RT	TKP	TOTSSS	VTK	WLI
•	•	•	•	•	•	•	•	•	•	•	•	•	•	•	•	•	•	•	•	•	•	•	•	•	•	•	•

**Construction Upgrades**

APC	PE
•	•

**Door Options**

ALF	CG	DPSRR	MD	MFO
		•		

**VANITY SINK BASE  
SUPERCABINET™ with TILT-OUT  
TRAYS, 34 1/2" HIGH, 21" DEEP**

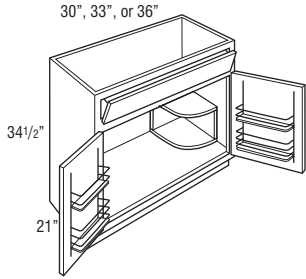

- Quarter Round Reversible Shelf for left or right applications will be constructed from 3/4" thick laminated furniture board. (Shelf shipped secure, can be positioned in left or right corner.)
- Each door features a chrome and wood two-tiered rack.
- Door rack width is 11 3/8" on 30" and 33" wide cabinets and 14 3/8" on 36" wide cabinet.
- Door rack depth is 3 1/2".
- Includes 2 installed tilt-out trays.
- Tilt-out trays are stain resistant, moisture resistant plastic to allow storage of sponges & other cleaning materials.
- Tilt-out trays are also available as an accessory for field installation. See page 375.
- All load bearing surfaces meet KCMA standards of 15 lbs. per square foot.

**Custom Modifications**

AUTH	CBO	CCO	CFNTO	CFP	CFRMO	CMAT	CND	DRWPWR	DRWTK	EXBK	EX	FB	FFD	FPEB	FTK	FTK_V	ID	INVFRM	LTI	MIP	RD	RECTK_	RT	TKP	TOTSSS	VTK	WLI
•	•	•	•	•	•	•	•	•	•	•	•	•	•	•	•	•	•	•	•	•	•	•	•	•	•	•	•

**Construction Upgrades**

APC	PE
•	•

**Door Options**

ALF	CG	DPSRR	MD	MFO
		•		

**VANITY BASE, SINGLE DOOR with  
DRAWER, 32" HIGH, 21" DEEP**

12", 15", 18", 21", or 24"

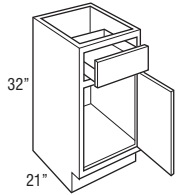

- **VB123221 L or R**
- **VB153221 L or R**
- **VB183221 L or R**
- **VB213221 L or R**
- **VB243221 L or R**

**Custom Modifications**

AUTH	CBO	CCO	CFNTO	CFP	CFRMO	CMAT	CND	DRWPWR	DRWTK	EXBK	EX	FB	FFD	FPEB	FTK	FTK_V	ID	INVFRM	LTI	MIP	RD	RECTK_	RT	TKP	TOTSSS	VTK	WLI
•	•	•	•	•	•	•	•	•	•*	•	•	•	•	•	•	•	•	•	•	•*	•	•	•	•	•	•	•

\*Not available on 12" and 15" wide

\*Not available on 12" wide

**Construction Upgrades**

APC	PE
•	•

**Door Options**

ALF	CG	DPSRR	MD	MFO
		•		

**VANITY BASE, SINGLE DOOR with  
DRAWER, 34 1/2" HIGH, 21" DEEP**

12", 15", 18", 21", or 24"

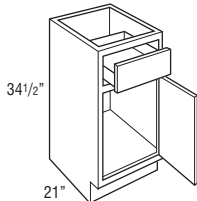

- **VB123421 L or R**
- **VB153421 L or R**
- **VB183421 L or R**
- **VB213421 L or R**
- **VB243421 L or R**

**Custom Modifications**

AUTH	CBO	CCO	CFNTO	CFP	CFRMO	CMAT	CND	DRWPWR	DRWTK	EXBK	EX	FB	FFD	FPEB	FTK	FTK_V	ID	INVFRM	LTI	MIP	RD	RECTK_	RT	TKP	TOTSSS	VTK	WLI
•	•	•	•	•	•	•	•	•*	•*	•	•	•	•	•	•	•	•	•	•	•*	•	•	•	•	•	•	•

\*Not available on 12" and 15" wide

\*Not available on 12" wide

**Construction Upgrades**

APC	PE
•	•

**Door Options**

ALF	CG	DPSRR	MD	MFO
		•		

**VANITY BASE, DOUBLE DOOR with DRAWER, 32" HIGH, 21" DEEP**

24", 27", 30", 33", or 36"

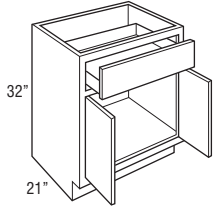

39", 42", 45", or 48"

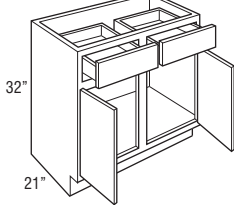

48"

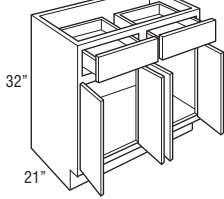

- VB243221
- VB273221
- VB303221
- VB333221
- VB363221

- VB393221
- VB423221
- VB453221
- VB483221CS

**VB483221**

**Custom Modifications**

AUTH	CBO	CCO	CFNTO	CFP	CFRMO	CMAT	CND	DRWPWR	DRWTK	EXBK	EX	FB	FFD	FPEB	FTK	FTK_V	ID	INVFRM	LTI	MIP	RD	RECTK_RT	TKP	TOTSSS	VTK	WLI
•	•	•	•	•	•	•	•	•	•*	•	•	•	•	•	•	•	•	•	•	•	•	•	•	•	•	•

\*Not available on 39", 42", 45" and 48" wide

**Construction Upgrades**

APC	PE
•	•

**Door Options**

ALF	CG	DPSRR	MD	MFO
•	•	•	•	•

**VANITY BASE, DOUBLE DOOR with DRAWER, 34 1/2" HIGH, 21" DEEP**

24", 27", 30", 33", or 36"

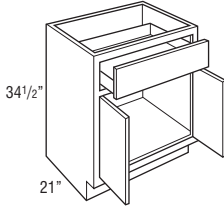

39", 42", 45", or 48"

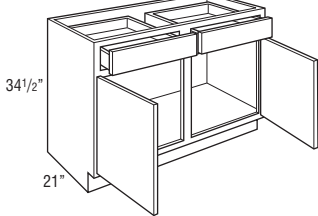

48"

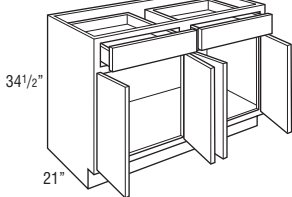

- VB243421
- VB273421
- VB303421
- VB333421
- VB363421

- VB393421
- VB423421
- VB453421
- VB483421CS

**VB483421**

**Custom Modifications**

AUTH	CBO	CCO	CFNTO	CFP	CFRMO	CMAT	CND	DRWPWR	DRWTK	EXBK	EX	FB	FFD	FPEB	FTK	FTK_V	ID	INVFRM	LTI	MIP	RD	RECTK_RT	TKP	TOTSSS	VTK	WLI
•	•	•	•	•	•	•	•	•	•*	•	•	•	•	•	•	•	•	•	•	•	•	•	•	•	•	•

\*Not available on 39", 42", 45" and 48" wide

**Construction Upgrades**

APC	PE
•	•

**Door Options**

ALF	CG	DPSRR	MD	MFO
•	•	•	•	•

**VANITY BASE EASY REACH,  
32" HIGH, 18" or 21" DEEP**

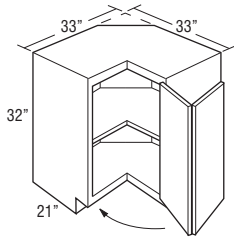
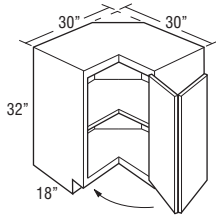

**VER303218 L or R  
VER333221 L or R**

- Decorative hardware screws must be countersunk to prevent scratching adjacent cabinets and face frame of VER.
- Includes one 1/2" thick fixed shelf in center of cabinet.
- Integrated soft-close hinge not included.

**Custom Modifications**

AUTH	CBO	CCO	CFNTO	CFP	CFRMO	CMAT	CND	DRWPWR	DRWTK	EXBK	EX	FB	FFD	FPEB	FTK	FTK_V	ID	INVFRM	LTI	MIP	RD	RECTK_	RT	TKP	TOTSSS	VTK	WLI	
		•	•										•		•					•	•		•				•	•

**Construction Upgrades**

APC	PE
•	•

**Door Options**

ALF	CG	DPSRR	MD	MFO
		•		

**VANITY BASE EASY REACH,  
34 1/2" HIGH, 21" DEEP**

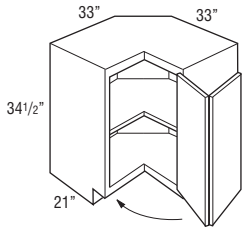

**VER333421 L or R**

- Decorative hardware screws must be countersunk to prevent scratching adjacent cabinets and face frame of VER.
- Includes one 1/2" thick fixed shelf in center of cabinet.
- Integrated soft-close hinge not included.

**Custom Modifications**

AUTH	CBO	CCO	CFNTO	CFP	CFRMO	CMAT	CND	DRWPWR	DRWTK	EXBK	EX	FB	FFD	FPEB	FTK	FTK_V	ID	INVFRM	LTI	MIP	RD	RECTK_	RT	TKP	TOTSSS	VTK	WLI	
		•	•										•		•						•	•		•			•	•

**Construction Upgrades**

APC	PE
•	•

**Door Options**

ALF	CG	DPSRR	MD	MFO
		•		

**VANITY DRAWER BASE,  
32" HIGH, 21" DEEP**

12", 15", 18", 21", 24",  
27", 30", 33", or 36"

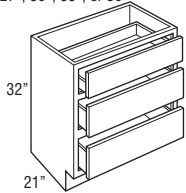

- VDB123221**
- VDB153221**
- VDB183221**
- VDB213221**
- VDB243221**
- VDB273221**
- VDB303221**
- VDB333221**
- VDB363221**

**Custom Modifications**

AUTH	CBO	CCO	CFNTO	CFP	CFRMO	CMAT	CND	DRWPWR	DRWTK	EXBK	EX	FB	FFD	FPEB	FTK	FTK_V	ID	INVFRM	LTI	MIP	RD	RECTK_	RT	TKP	TOTSSS	VTK	WLI	
		•	•		•	•		•*	•*	•	•	•	•	•	•	•	•					•	•				•	•

\*Not available on 12" and 15" wide

\*Not available on 12" wide

**Construction Upgrades**

APC	PE
•	•

**Door Options**

ALF	CG	DPSRR	MD	MFO

**VANITY DRAWER BASE,  
34 1/2" HIGH, 21" DEEP**

12", 15", 18", 21", 24",  
27", 30", 33", or 36"

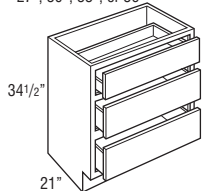

- VDB123421
- VDB153421
- VDB183421
- VDB213421
- VDB243421
- VDB273421
- VDB303421
- VDB333421
- VDB363421

**Custom Modifications**

AUTH	CBO	CCO	CFNTO	CFP	CFRMO	CMAT	CND	DRWPWR	DRWTK	EXBK	EX	FB	FFD	FPEB	FTK	FTK_V	ID	INVFRM	LTI	MIP	RD	RECTK_	RT	TKP	TOTSSS	VTK	WLI
•	•	•	•	•	•			•*	•*	•	•	•	•	•	•	•*	•				•	•				•	

\*Not available on 12" and 15" wide    \*Not available on 12" wide

**Construction Upgrades**

APC	PE
•	•

**Door Options**

ALF	CG	DPSRR	MD	MFO

**VANITY FOUR DRAWER BASE,  
34 1/2" HIGH, 21" DEEP**

12", 15", 18", or 21"

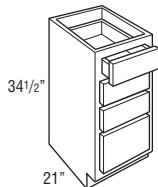

24", 27", 30", 33", or 36"

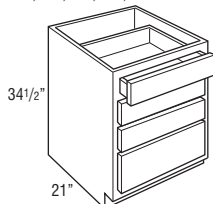

- 4VDB123421
- 4VDB153421
- 4VDB183421
- 4VDB213421

- 4VDB243421
- 4VDB273421
- 4VDB303421
- 4VDB333421
- 4VDB363421

**Custom Modifications**

AUTH	CBO	CCO	CFNTO	CFP	CFRMO	CMAT	CND	DRWPWR	DRWTK	EXBK	EX	FB	FFD	FPEB	FTK	FTK_V	ID	INVFRM	LTI	MIP	RD	RECTK_	RT	TKP	TOTSSS	VTK	WLI
•	•	•	•	•	•			•*	•*	•	•	•	•	•	•	•*	•				•	•				•	

\*Not available on 12" and 15" wide    \*Not available on 12" wide

**Construction Upgrades**

APC	PE
•	•

**Door Options**

ALF	CG	DPSRR	MD	MFO

**VANITY BASE WASTEBASKET,  
34 1/2" HIGH, 21" DEEP**

15"

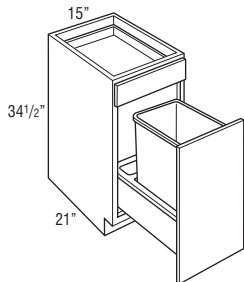

**VBWB153421**

- Includes one 35 quart gray wastebasket and one trash bag storage area.
- Pull-out features undermount smart close guides.
- Base Wastebasket Lid (BWBLID) fits 35 quart wastebaskets. See page 370.

**Custom Modifications**

AUTH	CBO	CCO	CFNTO	CFP	CFRMO	CMAT	CND	DRWPWR	DRWTK	EXBK	EX	FB	FFD	FPEB	FTK	FTK_V	ID	INVFRM	LTI	MIP	RD	RECTK_	RT	TKP	TOTSSS	VTK	WLI
•	•	•	•	•	•			•	•	•	•	•	•	•	•	•	•				•	•				•	

**Construction Upgrades**

APC	PE
•	•

**Door Options**

ALF	CG	DPSRR	MD	MFO

**VANITY WASTEBASKET FULL HEIGHT, 32" HIGH, 21" DEEP**

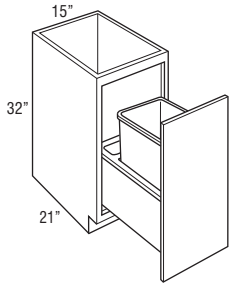

**VWB153221**

- Includes one 35 quart gray wastebasket and one trash bag storage area.
- Pull-out features undermount smart close guides.
- Base Wastebasket Lid (BWBLID) fits 35 quart wastebaskets. See page 370.

**Custom Modifications**

AUTH	CBO	CCO	CFNTO	CFP	CFRMO	CMAT	CND	DRWPWR	DRWTK	EXBK	EX	FB	FFD	FPEB	FTK	FTK_V	ID	INVFRM	LTI	MIP	RD	RECTK_	RT	TKP	TOTSSS	VTK	WLI
•	•	•			•					•	•	•		•	•	•				•		•				•	•

**Construction Upgrades**

APC	PE
•	•

**Door Options**

ALF	CG	DPSRR	MD	MFO

**VANITY WASTEBASKET FULL HEIGHT with ROLL TRAY, 32" HIGH, 21" DEEP**

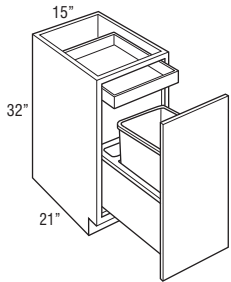

**VWB153221RT**

- Includes one 35 quart gray wastebasket and one trash bag storage area.
- Pull-out features undermount smart close guides.
- 1 roll tray standard.
- Not compatible with BWBLID due to limited height clearance.

**Custom Modifications**

AUTH	CBO	CCO	CFNTO	CFP	CFRMO	CMAT	CND	DRWPWR	DRWTK	EXBK	EX	FB	FFD	FPEB	FTK	FTK_V	ID	INVFRM	LTI	MIP	RD	RECTK_	RT	TKP	TOTSSS	VTK	WLI
•	•	•			•					•	•	•		•	•	•				•		•				•	•

**Construction Upgrades**

APC	PE
•	•

**Door Options**

ALF	CG	DPSRR	MD	MFO

**VANITY WASTEBASKET FULL HEIGHT, 34 1/2" HIGH, 21" DEEP**

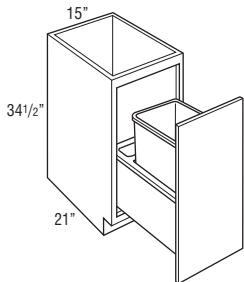

**VWB153421**

- Includes one 35 quart gray wastebasket and one trash bag storage area.
- Pull-out features undermount smart close guides.
- Base Wastebasket Lid (BWBLID) fits 35 quart wastebaskets. See page 370.

**Custom Modifications**

AUTH	CBO	CCO	CFNTO	CFP	CFRMO	CMAT	CND	DRWPWR	DRWTK	EXBK	EX	FB	FFD	FPEB	FTK	FTK_V	ID	INVFRM	LTI	MIP	RD	RECTK_	RT	TKP	TOTSSS	VTK	WLI
•	•	•			•					•	•	•		•	•	•				•		•				•	•

**Construction Upgrades**

APC	PE
•	•

**Door Options**

ALF	CG	DPSRR	MD	MFO



**VANITY WASTEBASKET FULL HEIGHT with ROLL TRAY, 34 1/2" HIGH, 21" DEEP**

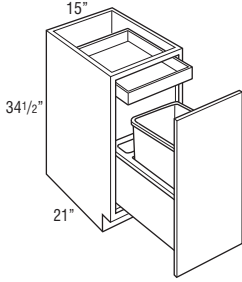

**VWB153421RT**

- Includes one 35 quart gray wastebasket and one trash bag storage area.
- Pull-out features undermount smart close guides.
- 1 roll tray standard.
- Base Wastebasket Lid (BWBLID) fits 35 quart wastebaskets. See page 370.

**Custom Modifications**

AUTH	CBO	CCO	CFNTO	CFP	CFRMO	CMAT	CND	DRWPWR	DRWTK	EXBK	EX	FB	FFD	FPEB	FTK	FTK_V	ID	INVFRM	LTI	MIP	RD	RECTK_	RT	TKP	TOTSSS	VTK	WLI
•	•	•			•					•	•	•		•	•	•				•		•				•	•

**Construction Upgrades**

APC	PE
•	•

**Door Options**

ALF	CG	DPSRR	MD	MFO

**VANITY PULL-OUT, 34 1/2" HIGH, 21" DEEP**

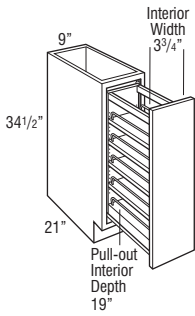

**VP93421**

- Natural Finish with smart close full extension wood pull-out with adjustable shelves and chrome rail sides.
- Pull-out is 19 9/16" deep.

**Custom Modifications**

AUTH	CBO	CCO	CFNTO	CFP	CFRMO	CMAT	CND	DRWPWR	DRWTK	EXBK	EX	FB	FFD	FPEB	FTK	FTK_V	ID	INVFRM	LTI	MIP	RD	RECTK_	RT	TKP	TOTSSS	VTK	WLI	
•	•	•			•					•	•	•		•	•						•		•*				•	•

\*RECTKALL not available

**Construction Upgrades**

APC	PE
•	•

**Door Options**

ALF	CG	DPSRR	MD	MFO
		•		

**VANITY GROOMING PULL-OUT, 34 1/2" HIGH, 21" DEEP**

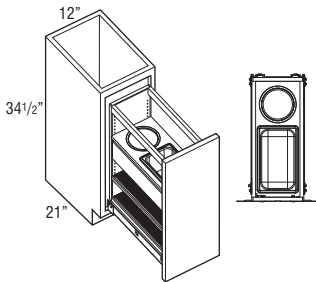

**VGPO123421**

- Natural Finish with smart close full extension wood pull-out with adjustable shelves and chrome rail sides.
- Pull-out is 19 9/16" deep.
- Features adjustable shelves with non-skid vinyl liners and clear polycarbonate rails.
- Includes two stainless steel bins (one rectangular and one round) for storing items such as curling irons and hair dryers.

**Custom Modifications**

AUTH	CBO	CCO	CFNTO	CFP	CFRMO	CMAT	CND	DRWPWR	DRWTK	EXBK	EX	FB	FFD	FPEB	FTK	FTK_V	ID	INVFRM	LTI	MIP	RD	RECTK_	RT	TKP	TOTSSS	VTK	WLI	
•	•	•			•					•	•	•		•	•						•		•				•	•

**Construction Upgrades**

APC	PE
•	•

**Door Options**

ALF	CG	DPSRR	MD	MFO
		•		

**VANITY SINK DRAWER BASE,  
32" HIGH, 21" DEEP**

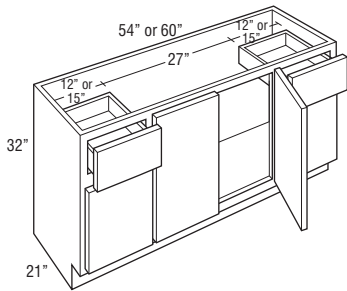
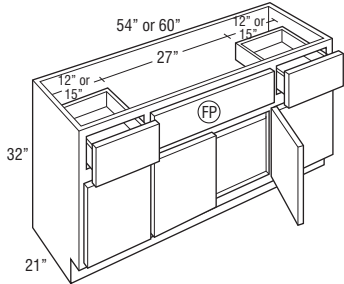
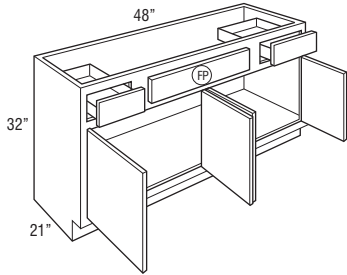
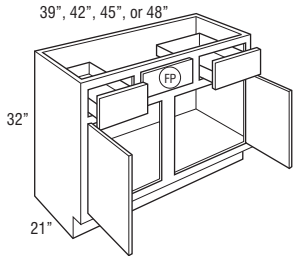
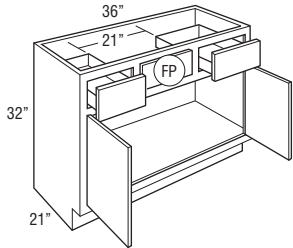

FP = False Panel

2VSD363221

2VSD393221

2VSD423221

2VSD453221

2VSD483221CS

2VSD483221

2VSD543221FP

2VSD603221FP

2VSD543221

2VSD603221

	Face Frame Opening Width			Available Sink Clearance Width	# of Sink Openings	# of Drawers
	Drawers	Side Doors	False Panel			
2VSD36...	6"	33" (butt doors)	15"	21"	1	2
2VSD39...	9"	16 1/2"	15"	18"	1	2
2VSD42...	9"	18"	15"	21"	1	2
2VSD45...	9"	19 1/2"	18"	24"	1	2
2VSD48...CS	12"	21"	15"	21"	1	2
2VSD48...	12"	21"	15"	21"	1	2
2VSD54...	12"	21"	15"	21"	1	2
2VSD54...	12"	21"	15"	21"	1	2
2VSD60...	15"	15"	21"	27"	1	2

**Custom Modifications**

AUTH	CBO	CCO	CFNTO	CFP	CFRMO	CMAT	CND	DRWPWR	DRWTK	EXBK	EX	FB	FFD	FPEB	FTK	FTK_V	ID	INVFRM	LTI	MIP	RD	RECTK_	RT	TKP	TOTSSS	VTK	WLI
•	•	•	•	•	•	•*	•	•*	•▲	•	•	•	•	•	•	•	•	•	•	•	•	•	•	•	•	•	•

\*Not available on 39", 42", and 45" wide    \*Available only on 60" wide    ▲Available only on 36" wide    †Available only on 36", 39", 42", 45", and 48" wide

‡Available only on cabinets with false panels

**Construction Upgrades**

APC	PE
•	•

**Door Options**

ALF	CG	DPSRR	MD	MFO
		•		

**VANITY SINK DRAWER BASE,  
34 1/2" HIGH, 21" DEEP**

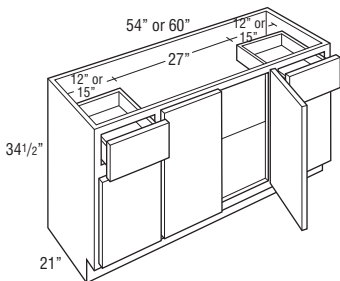
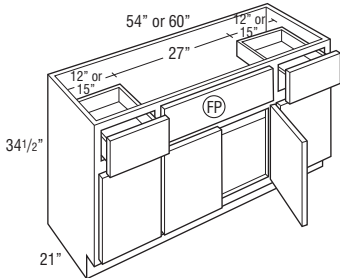
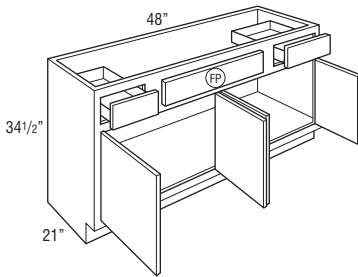
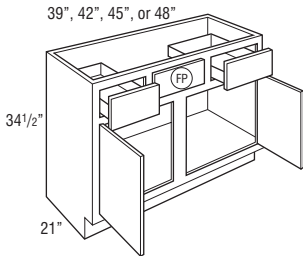
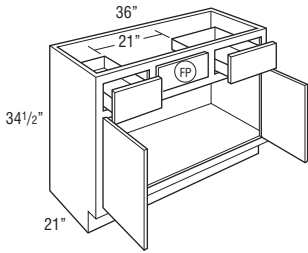

**FP** = False Panel

**2VSD363421**

**2VSD393421**

**2VSD423421**

**2VSD453421**

**2VSD483421CS**

**2VSD483421**

**2VSD543421FP**

**2VSD603421FP**

**2VSD543421**

**2VSD603421**

	Face Frame Opening Width			Available Sink Clearance Width	# of Sink Openings	# of Drawers
	Drawers	Side Doors	False Panel			
2VSD36...	6"	33" (butt doors)	15"	21"	1	2
2VSD39...	9"	16 1/2"	15"	18"	1	2
2VSD42...	9"	18"	15"	21"	1	2
2VSD45...	9"	19 1/2"	18"	24"	1	2
2VSD48...CS	12"	21"	15"	21"	1	2
2VSD48...	12"	21"	15"	21"	1	2
2VSD54...	12"	12"	21"	27"	1	2
2VSD60...	15"	15"	21"	27"	1	2

**Custom Modifications**

AUTH	CBO	CCO	CFNTO	CFP	CFRMO	CMAT	CND	DRWPWR	DRWTK	EXBK	EX	FB	FFD	FPEB	FTK	FTK_V	ID	INVFRM	LTI	MIP	RD	RECTK_	RT	TKP	TOTSSS	VTK	WLI
•	•	•	•	•	•	•*	•	•+	•▲	•	•	•	•	•	•	•	•	•	•	•	•	•	•	•	•	•	•

\*Not available on 39", 42", and 45" wide    ▲Available only on 60" wide    ▲Available only on 36" wide    †Available only on 36", 39", 42", 45", and 48" wide

‡Available only on cabinets with false panels

**Construction Upgrades**

APC	PE
•	•

**Door Options**

ALF	CG	DPSRR	MD	MFO
•	•	•	•	•

**VANITY SINK DRAWER BASE,  
32" HIGH, 21" DEEP**

24", 27", 30", or 33"

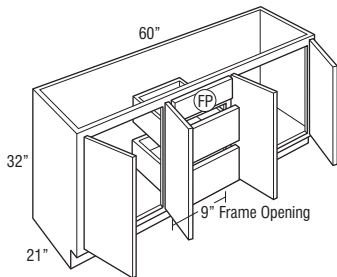
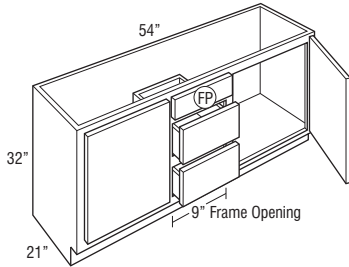
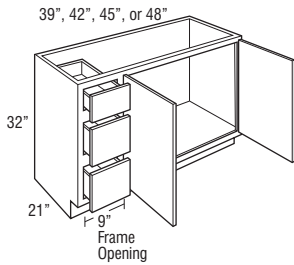
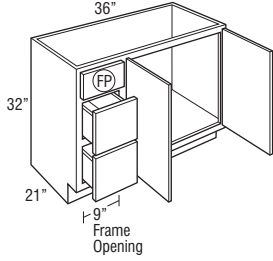
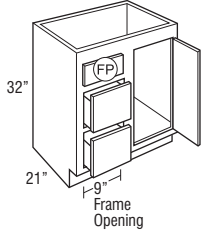

**FP** = False Panel

- VSD243221 DL or DR
- VSD273221 DL or DR
- VSD303221 DL or DR
- VSD333221 DL or DR

VSD363221 DL or DR

- VSD393221 DL or DR
- VSD423221 DL or DR
- VSD453221 DL or DR
- VSD483221 DL or DR

VSDS543221FH

VSDS603221FH

- DL or DR indicates drawer location.
- CFP is available on 39", 42", 45", and 48" widths, but standard on all other widths.

	Face Frame Opening Width		Available Sink Clearance Width	# of Sink Openings	# of Drawers
	Drawers	Doors			
VSD24...	9"	9"	21"	1	2
VSD27...	9"	12"	24"	1	2
VSD30...	9"	15"	27"	1	2
VSD33...	9"	18"	30"	1	2
VSD36...	9"	21"	33"	1	2
VSD39...	9"	24"	27"	1	3
VSD42...	9"	27"	30"	1	3
VSD45...	9"	30"	33"	1	3
VSD48...	9"	33"	36"	1	3
VSDS54...	9"	18"	21"	2	2
VSDS60...	9"	21"	24"	2	2

**Custom Modifications**

AUTH	CBO	CCO	CFNTO	CFP	CFRMO	CMAT	CND	DRWPWR	DRWTK	EXBK	EX	FB	FFD	FPEB	FTK	FTK_V	ID	INVFRM	LTI	MIP	RD	RECTK_	RT	TKP	TOTSSS	VTK	WLI
•	•	•		STD		•*	•		•+	•	•	•	•	•	•	•	•			•▲	•	•				•	•

\*Not available on 24", 27", 30", 33", and 60" wide    \*Not available on 39", 42", 45", 48", 54", and 60" wide    ▲Not available on 24" wide

**Construction Upgrades**

APC	PE
•	•

**Door Options**

ALF	CG	DPSRR	MD	MFO
		•		

**VANITY SINK DRAWER BASE,  
34 1/2" HIGH, 21" DEEP**

24", 27", 30", or 33"

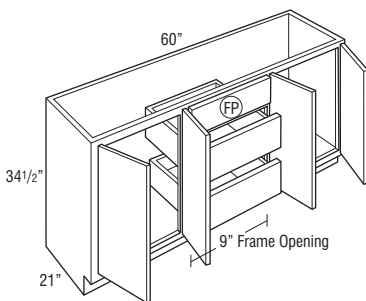
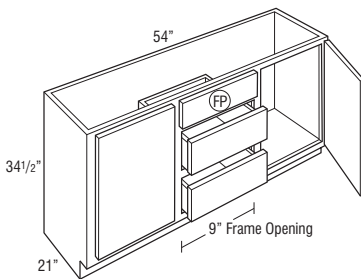
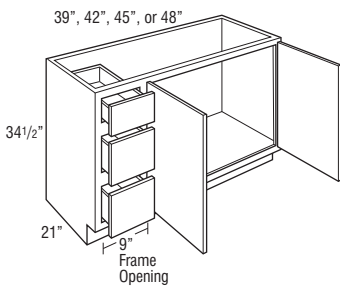
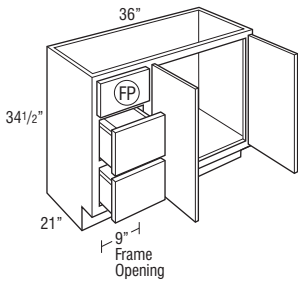
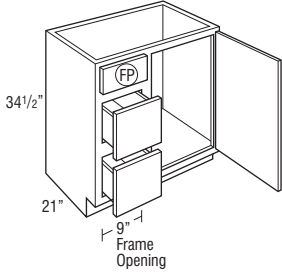

**(FP) = False Panel**

- VSD243421 DL or DR
- VSD273421 DL or DR
- VSD303421 DL or DR
- VSD333421 DL or DR

VSD363421 DL or DR

- VSD393421 DL or DR
- VSD423421 DL or DR
- VSD453421 DL or DR
- VSD483421 DL or DR

VSD5543421FH

VSD5603421FH

- DL or DR indicates drawer location.
- CFP is available on 39", 42", 45", and 48" widths, but standard on all other widths.

	Face Frame Opening Width		Available Sink Clearance Width	# of Sink Openings	# of Drawers
	Drawers	Doors			
VSD24...	9"	9"	21"	1	2
VSD27...	9"	12"	24"	1	2
VSD30...	9"	15"	27"	1	2
VSD33...	9"	18"	30"	1	2
VSD36...	9"	21"	33"	1	2
VSD39...	9"	24"	27"	1	3
VSD42...	9"	27"	30"	1	3
VSD45...	9"	30"	33"	1	3
VSD48...	9"	33"	36"	1	3
VSD554...	9"	18"	21"	2	2
VSD560...	9"	21"	24"	2	2

**Custom Modifications**

AUTH	CBO	CCO	CFNTO	CFP	CFRMO	CMAT	CND	DRWPWR	DRWTK	EXBK	EX	FB	FFD	FPEB	FTK	FTK_V	ID	INVFRM	LTI	MIP	RD	RECTK_	RT	TKP	TOTSSS	VTK	WLI
•	•	•		STD	•	•*	•		•*	•	•	•	•	•	•	•	•	•	•	•	•	•	•	•	•	•	•

\*Not available on 24", 27", 30", 33", and 60" wide    \*Not available on 39", 42", 45", 48", 54", and 60" wide    \*Not available on 24" wide

**Construction Upgrades**

APC	PE
•	•

**Door Options**

ALF	CG	DPSRR	MD	MFO
		•		

**VANITY SINK DRAWER BASE with FALSE PANEL, 32" HIGH, 21" DEEP**

24", 27", 30", or 33"

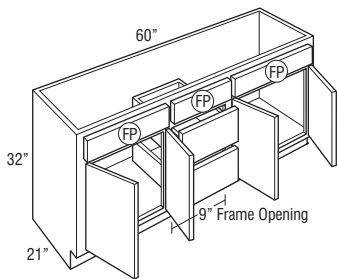
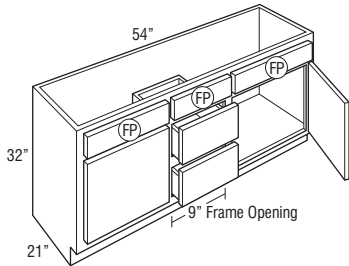
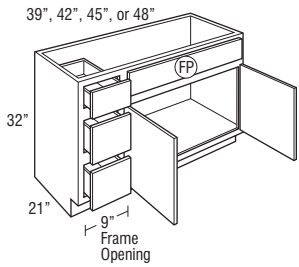
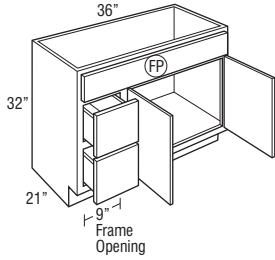
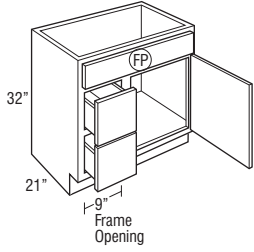

FP = False Panel

- VSD243221FP DL or DR
- VSD273221FP DL or DR
- VSD303221FP DL or DR
- VSD333221FP DL or DR

VSD363221FP DL or DR

- VSD393221FP DL or DR
- VSD423221FP DL or DR
- VSD453221FP DL or DR
- VSD483221FP DL or DR

VSD543221FP

VSDS603221FP

- DL or DR indicates drawer location.
- CFP is available on 42", 45", and 48" widths, but standard on all other widths.

	Face Frame Opening Width		Available Sink Clearance Width	# of Sink Openings	# of Drawers
	Drawers	Doors			
VSD24...	9"	9"	21"	1	2
VSD27...	9"	12"	24"	1	2
VSD30...	9"	15"	27"	1	2
VSD33...	9"	18"	30"	1	2
VSD36...	9"	21"	33"	1	2
VSD39...	9"	24"	27"	1	3
VSD42...	9"	27"	30"	1	3
VSD45...	9"	30"	33"	1	3
VSD48...	9"	33"	36"	1	3
VSDS54...	9"	18"	21"	2	2
VSDS60...	9"	21"	24"	2	2

**Custom Modifications**

AUTH	CBO	CCO	CFNTO	CFP	CFRMO	CMAT	CND	DRWPWR	DRWTK	EXBK	EX	FB	FFD	FPEB	FTK	FTK_V	ID	INVFRM	LTI	MIP	RD	RECTK_RT	TKP	TOTSSS	VTK	WLI
•	•	•		STD		•*	•		•+	•	•	•	•	•	•	•	•			•▲	•	•		•	•	•

\*Not available on 24", 27", 30", 33", and 60" wide    +Not available on 39", 42", 45", 48", 54", and 60" wide    ▲Not available on 24" wide

**Construction Upgrades**

APC	PE
•	•

**Door Options**

ALF	CG	DPSRR	MD	MFO
		•		

**VANITY SINK DRAWER BASE with FALSE PANEL, 34 1/2" HIGH, 21" DEEP**

24", 27", 30", or 33"

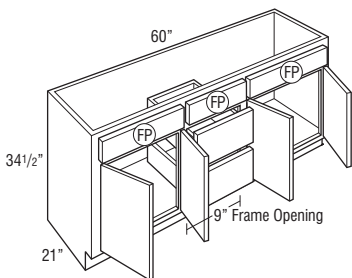
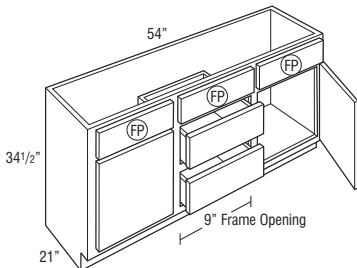
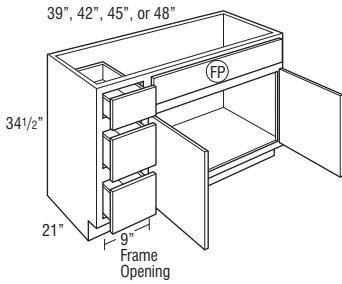
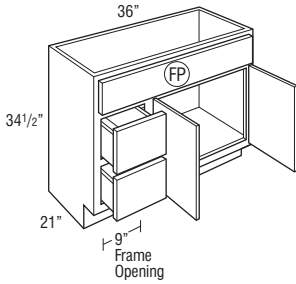
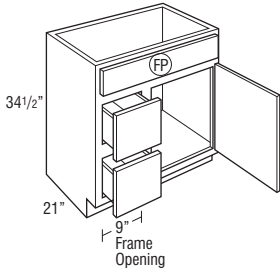

**FP = False Panel**

VSD243421FP DL or DR  
 VSD273421FP DL or DR  
 VSD303421FP DL or DR  
 VSD333421FP DL or DR

VSD363421FP DL or DR

VSD393421FP DL or DR  
 VSD423421FP DL or DR  
 VSD453421FP DL or DR  
 VSD483421FP DL or DR

VSDS543421FP

VSDS603421FP

- DL or DR indicates drawer location.
- CFP is available on 42", 45", and 48" widths, but standard on all other widths.

	Face Frame Opening Width		Available Sink Clearance Width	# of Sink Openings	# of Drawers
	Drawers	Doors			
VSD24...	9"	9"	21"	1	2
VSD27...	9"	12"	24"	1	2
VSD30...	9"	15"	27"	1	2
VSD33...	9"	18"	30"	1	2
VSD36...	9"	21"	33"	1	2
VSD39...	9"	24"	27"	1	3
VSD42...	9"	27"	30"	1	3
VSD45...	9"	30"	33"	1	3
VSD48...	9"	33"	36"	1	3
VSDS54...	9"	18"	21"	2	2
VSDS60..	9"	21"	24"	2	2

**Custom Modifications**

AUTH	CBO	CCO	CFNTO	CFP	CFRMO	CMAT	CND	DRWPWR	DRWTK	EXBK	EX	FB	FFD	FPEB	FTK	FTK_V	ID	INVFRM	LTI	MIP	RD	RECT_	RT	TKP	TOTSSS	VTK	WLI
•	•	•		STD	•	•*	•		•*	•	•	•	•	•	•	•	•	•	•	•	•	•	•	•	•	•	•

\*Not available on 24", 27", 30", 33", and 60" wide \*Not available on 39", 42", 45", 48", 54", and 60" wide ▲Not available on 24" wide

**Construction Upgrades**

APC	PE
•	•

**Door Options**

ALF	CG	DPSRR	MD	MFO
		•		

**VANITY SINK WIDE DRAWER BASE with FALSE PANELS, 32" HIGH, 21" DEEP**

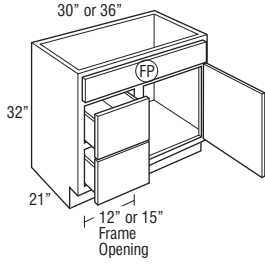

FP = False Panel

**VSWD303221FP DL or DR**  
**VSWD363221FP DL or DR**

• DL or DR indicates drawer location.

	Face Frame Opening Width		Available Sink Clearance Width	# of Sink Openings	# of Drawers
	Drawers	Doors			
VSWD30..	12"	12"	27"	1	2
VSWD36..	15"	15"	33"	1	2

**Custom Modifications**

AUTH	CBO	CCO	CFNTO	CFP	CFRMO	CMAT	CND	DRWPWR	DRWTK	EXBK	EX	FB	FFD	FPEB	FTK	FTK_V	ID	INVFRM	LTI	MIP	RD	RECTK_	RT	TKP	TOTSSS	VTK	WLI
•	•	•	•	STD	•	•	•	•	•	•	•	•	•	•	•	•	•	•	•	•	•	•	•	•	•	•	•

**Construction Upgrades**

APC	PE
•	•

**Door Options**

ALF	CG	DPSRR	MD	MFO
•	•	•	•	•

**VANITY SINK WIDE DRAWER BASE with FALSE PANELS, 34 1/2" HIGH, 21" DEEP**

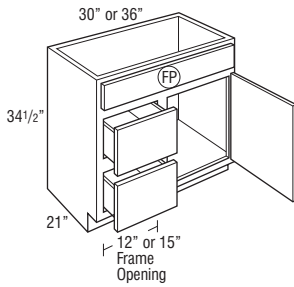

FP = False Panel

**VSWD303421FP DL or DR**  
**VSWD363421FP DL or DR**

• DL or DR indicates drawer location.

	Face Frame Opening Width		Available Sink Clearance Width	# of Sink Openings	# of Drawers
	Drawers	Doors			
VSWD30..	12"	12"	27"	1	2
VSWD36..	15"	15"	33"	1	2

**Custom Modifications**

AUTH	CBO	CCO	CFNTO	CFP	CFRMO	CMAT	CND	DRWPWR	DRWTK	EXBK	EX	FB	FFD	FPEB	FTK	FTK_V	ID	INVFRM	LTI	MIP	RD	RECTK_	RT	TKP	TOTSSS	VTK	WLI
•	•	•	•	STD	•	•	•	•	•	•	•	•	•	•	•	•	•	•	•	•	•	•	•	•	•	•	•

**Construction Upgrades**

APC	PE
•	•

**Door Options**

ALF	CG	DPSRR	MD	MFO
•	•	•	•	•

**VANITY SINK THREE DRAWER BASE, 32" HIGH, 21" DEEP**

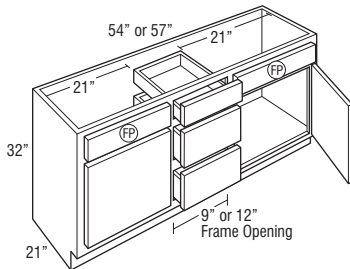

**VSDS543221**  
**VSDS573221**

**VSDS603221**

	Face Frame Opening Width		Available Sink Clearance Width	# of Sink Openings	# of Drawers
	Drawers	Doors			
VSDS54...	9"	18"	21"	2	3
VSDS57...	12"	18"	21"	2	3
VSDS60...	9"	21"	24"	2	3

**Custom Modifications**

AUTH	CBO	CCO	CFNTO	CFP	CFRMO	CMAT	CND	DRWPWR	DRWTK	EXBK	EX	FB	FFD	FPEB	FTK	FTK_V	ID	INVFRM	LTI	MIP	RD	RECTK_	RT	TKP	TOTSSS	VTK	WLI
•	•	•	•	•	•	•	•	•	•	•	•	•	•	•	•	•	•	•	•	•	•	•	•	•	•	•	•

**Construction Upgrades**

APC	PE
•	•

**Door Options**

ALF	CG	DPSRR	MD	MFO
•	•	•	•	•

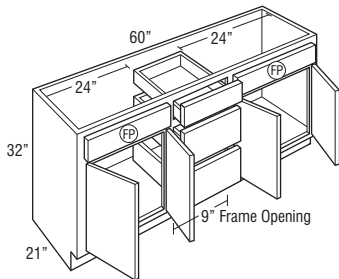



**VANITY SINK THREE DRAWER BASE,  
34 1/2" HIGH, 21" DEEP**

**VSDS543421**  
**VSDS573421**

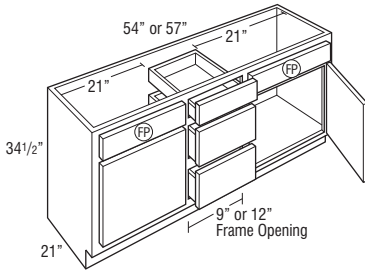

**VSDS603421**

	Face Frame Opening Width		Available Sink Clearance Width	# of Sink Openings	# of Drawers
	Drawers	Doors			
VSDS54...	9"	18"	21"	2	3
VSDS57...	12"	18"	21"	2	3
VSDS60...	9"	21"	24"	2	3

**Custom Modifications**

AUTH	CBO	CCO	CFNTO	CFP	CFRMO	CMAT	CND	DRWPWR	DRWTK	EXBK	EX	FB	FFD	FPEB	FTK	FTK_V	ID	INVERM	LTI	MIP	RD	RECTK_RT	TKP	TOTSSS	VTK	WLI	
•	•	•	•	•	•	•	•	•	•	•	•	•	•	•	•	•	•	•	•	•	•	•	•	•	•	•	•

**Construction Upgrades**

APC	PE
•	•

**Door Options**

ALF	CG	DPSRR	MD	MFO
•	•	•	•	•

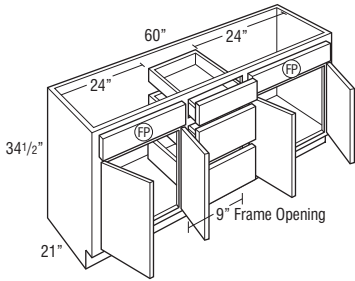

**VANITY SINK DRAWER BASE with  
SIX DRAWERS, 32" HIGH,  
21" DEEP**

**6VSD423221 L or R**

**6VSD483221**

**6VSD543221**

**6VSD603221**

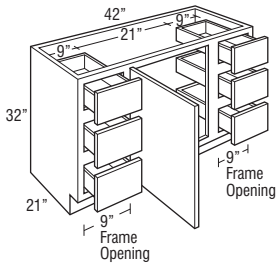

	Face Frame Opening Width		Available Sink Clearance Width	# of Sink Openings	# of Drawers
	Drawers	Doors			
6VSD42...	9"	15"	21"	1	6
6VSD48...	9"	21"	27"	1	6
6VSD54...	12"	21"	27"	1	6
6VSD60...	15"	21"	27"	1	6

**Custom Modifications**

AUTH	CBO	CCO	CFNTO	CFP	CFRMO	CMAT	CND	DRWPWR	DRWTK	EXBK	EX	FB	FFD	FPEB	FTK	FTK_V	ID	INVERM	LTI	MIP	RD	RECTK_RT	TKP	TOTSSS	VTK	WLI	
•	•	•	•	•	•	•*	•	•	•	•	•	•	•	•	•	•	•	•	•	•	•	•	•	•	•	•	•

**Construction Upgrades**

APC	PE
•	•

**Door Options**

ALF	CG	DPSRR	MD	MFO
•	•	•	•	•

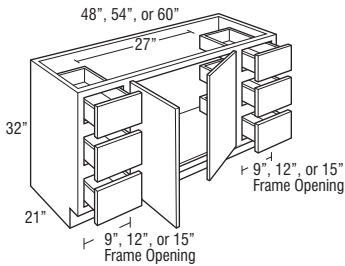

\*Not available on 42" wide

\*Available only on 60" wide

**VANITY SINK DRAWER BASE with SIX DRAWERS, 34 1/2" HIGH, 21" DEEP**

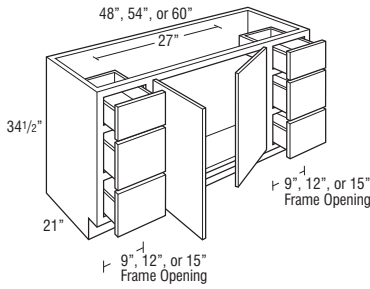
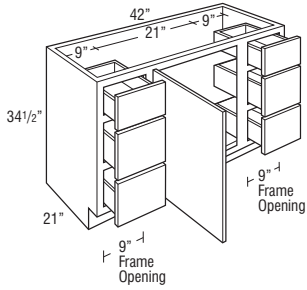

6VSD423421 L or R

6VSD483421

6VSD543421

6VSD603421

	Face Frame Opening Width		Available Sink Clearance Width	# of Sink Openings	# of Drawers
	Drawers	Doors			
6VSD42...	9"	15"	21"	1	6
6VSD48...	9"	21"	27"	1	6
6VSD54...	12"	21"	27"	1	6
6VSD60...	15"	21"	27"	1	6

**Custom Modifications**

AUTH	CBO	CCO	CFNTO	CFP	CFRMO	CMAT	CND	DRWPWR	DRWTK	EXBK	EX	FB	FFD	FPEB	FTK	FTK_V	ID	INVFRM	LTI	MIP	RD	RECTK_	RT	TKP	TOTSSS	VTK	WLL
•	•	•				•*		•*		•	•	•		•	•	•	•			•	•	•				•	•

\*Not available on 42" wide \*Available only on 60" wide

**Construction Upgrades**

APC	PE
•	•

**Door Options**

ALF	CG	DPSRR	MD	MFO
		•		

**VANITY SINK DRAWER BASE with SIX DRAWERS & FALSE PANEL, 32" HIGH, 21" DEEP**

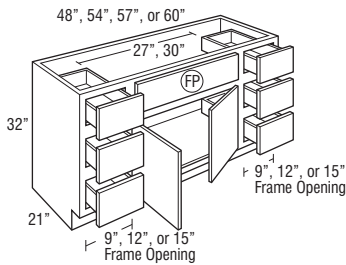
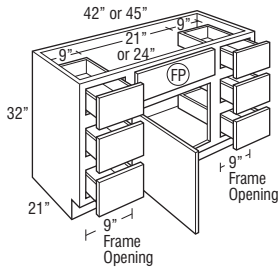

6VSD423221FP L or R

6VSD453221FP L or R

6VSD483221FP

6VSD543221FP

6VSD573221FP

6VSD603221FP

	Face Frame Opening Width		Available Sink Clearance Width	# of Sink Openings	# of Drawers
	Drawers	Doors			
6VSD42...	9"	15"	21"	1	6
6VSD45...	9"	18"	24"	1	6
6VSD48...	9"	21"	27"	1	6
6VSD54...	12"	21"	27"	1	6
6VSD57...	12"	24"	30"	1	6
6VSD60...	15"	21"	27"	1	6

**Custom Modifications**

AUTH	CBO	CCO	CFNTO	CFP	CFRMO	CMAT	CND	DRWPWR	DRWTK	EXBK	EX	FB	FFD	FPEB	FTK	FTK_V	ID	INVFRM	LTI	MIP	RD	RECTK_	RT	TKP	TOTSSS	VTK	WLL
•	•	•				•*		•*		•	•	•		•	•	•	•			•	•	•				•	•

\*Not available on 42" and 45" wide \*Available only on 60" wide

**Construction Upgrades**

APC	PE
•	•

**Door Options**

ALF	CG	DPSRR	MD	MFO
		•		

**VANITY SINK DRAWER BASE with SIX DRAWERS & FALSE PANEL, 34 1/2" HIGH, 21" DEEP**

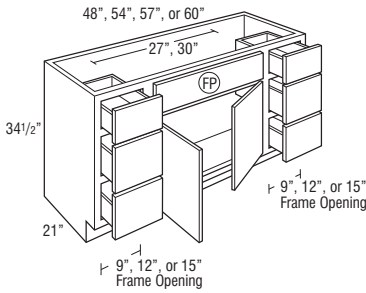
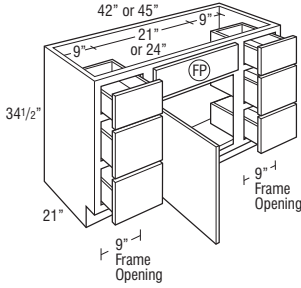

6VSD423421FP L or R  
6VSD453421FP L or R

6VSD483421FP  
6VSD543421FP  
6VSD573421FP  
6VSD603421FP

	Face Frame Opening Width		Available Sink Clearance Width	# of Sink Openings	# of Drawers
	Drawers	Doors			
6VSD42...	9"	15"	21"	1	6
6VSD45...	9"	18"	24"	1	6
6VSD48...	9"	21"	27"	1	6
6VSD54...	12"	21"	27"	1	6
6VSD57...	12"	24"	30"	1	6
6VSD60...	15"	21"	27"	1	6

**Custom Modifications**

AUTH	CBO	CCO	CFNTO	CFP	CFRMO	CMAT	CND	DRWPWR	DRWTK	EXBK	EX	FB	FFD	FPEB	FTK	FTK_V	ID	INVFRM	LTI	MIP	RD	RECTK_	RT	TKP	TOTSSS	VTK	WLI
•	•	•	•	•	•	•*	•	•*	•	•	•	•	•	•	•	•	•	•	•	•	•	•	•	•	•	•	•

\*Not available on 42" and 45" wide \*Available only on 60" wide

**Construction Upgrades**

APC	PE
•	•

**Door Options**

ALF	CG	DPSRR	MD	MFO
•	•	•	•	•

**VANITY SINK DRAWER BASE with EIGHT DRAWERS, 34 1/2" HIGH, 21" DEEP**

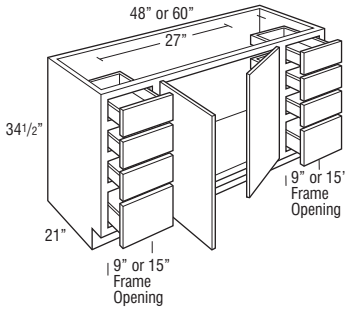

8VSD483421  
8VSD603421

	Face Frame Opening Width		Available Sink Clearance Width	# of Sink Openings	# of Drawers
	Drawers	Doors			
8VSD48...	9"	21"	27"	1	8
8VSD60...	15"	21"	27"	1	8

**Custom Modifications**

AUTH	CBO	CCO	CFNTO	CFP	CFRMO	CMAT	CND	DRWPWR	DRWTK	EXBK	EX	FB	FFD	FPEB	FTK	FTK_V	ID	INVFRM	LTI	MIP	RD	RECTK_	RT	TKP	TOTSSS	VTK	WLI
•	•	•	•	•	•	•	•	•*	•	•	•	•	•	•	•	•	•	•	•	•	•	•	•	•	•	•	•

\*Available only on 60" wide

**Construction Upgrades**

APC	PE
•	•

**Door Options**

ALF	CG	DPSRR	MD	MFO
•	•	•	•	•

**VANITY SINK DRAWER BASE with EIGHT DRAWERS & FALSE PANEL, 34 1/2" HIGH, 21" DEEP**

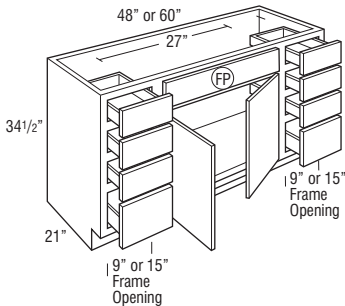

8VSD483421FP  
8VSD603421FP

	Face Frame Opening Width		Available Sink Clearance Width	# of Sink Openings	# of Drawers
	Drawers	Doors			
8VSD48...	9"	21"	27"	1	8
8VSD60...	15"	21"	27"	1	8

**Custom Modifications**

AUTH	CBO	CCO	CFNTO	CFP	CFRMO	CMAT	CND	DRWPWR	DRWTK	EXBK	EX	FB	FFD	FPEB	FTK	FTK_V	ID	INVFRM	LTI	MIP	RD	RECTK_	RT	TKP	TOTSSS	VTK	WLI
•	•	•	•	•	•	•	•	•*	•	•	•	•	•	•	•	•	•	•	•	•	•	•	•	•	•	•	•

\*Available only on 60" wide

**Construction Upgrades**

APC	PE
•	•

**Door Options**

ALF	CG	DPSRR	MD	MFO
•	•	•	•	•

**UNDER COUNTER DRAWER,  
4 3/4" HIGH, 21" DEEP**

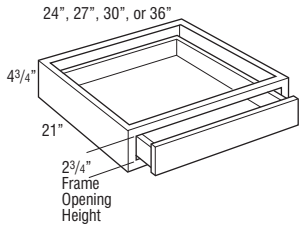

UCD2421

UCD2721



UCDS3021

UCDS3621

- Cabinet is 4 3/4" high. Drawer box within cabinet is 2" high (outside dimension).
- Not trimmable.
- Drawer front is 3/4" slab front.
- The frame to end panel offset is 3/4", which is designed to accommodate the vanity desk leg.
- End panels ordered in Standard construction will feature non-matching laminate exterior. When ordered in PE or APC, end panels will not be finished.
- Reduced depth is available in 3" increments.

**Custom Modifications**

AUTH	CBO	CCO	CFNTO	CFP	CFRMO	CMAT	CND	DRWPWR	DRWTK	EXBK	EX	FB	FFD	FPEB	FTK	FTK_V	ID	INVFRM	LTI	MIP	RD	RECTK_	RT	TKP	TOTSSS	VTK	WLI	
		•																										

**Construction Upgrades**

APC	PE
•	•

**Door Options**

ALF	CG	DPSRR	MD	MFO

**NEW UNDER COUNTER DRAWER  
TRIMMABLE, 4 3/4" HIGH,  
21" DEEP**

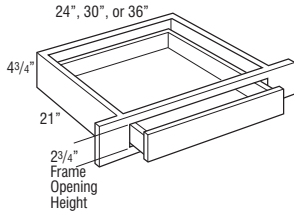

UCDT2421

UCDT3021

UCDT3621

- Cabinet is 4 3/4" high. Drawer box within cabinet is 2" high (outside dimension).
- Frame stile is trimmable 3" on each side.
- Drawer front is 3/4" slab front.
- The frame to end panel offset is 3/4", which is designed to accommodate the vanity desk leg.
- End panels ordered in Standard construction will feature non-matching laminate exterior. When ordered in PE or APC, end panels will not be finished.
- Reduced depth is available in 3" increments.

**Custom Modifications**

AUTH	CBO	CCO	CFNTO	CFP	CFRMO	CMAT	CND	DRWPWR	DRWTK	EXBK	EX	FB	FFD	FPEB	FTK	FTK_V	ID	INVFRM	LTI	MIP	RD	RECTK_	RT	TKP	TOTSSS	VTK	WLI	
		•																										

**Construction Upgrades**

APC	PE
•	•

**Door Options**

ALF	CG	DPSRR	MD	MFO

**VANITY HAMPER,  
32" HIGH, 21" DEEP**

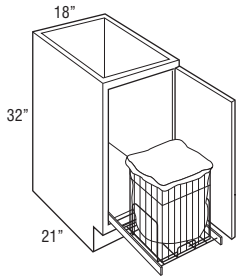

VH183221FH L or R

- Includes full extension removable chrome pull-out hamper with removable cloth liner.
- Hamper size is 19 3/8" high x 14 3/4" wide x 18" deep.

**Custom Modifications**

AUTH	CBO	CCO	CFNTO	CFP	CFRMO	CMAT	CND	DRWPWR	DRWTK	EXBK	EX	FB	FFD	FPEB	FTK	FTK_V	ID	INVFRM	LTI	MIP	RD	RECTK_	RT	TKP	TOTSSS	VTK	WLI	
		•																										

**Construction Upgrades**

APC	PE
•	•

**Door Options**

ALF	CG	DPSRR	MD	MFO
		•		

**VANITY HAMPER with DRAWER,  
34 1/2" HIGH, 21" DEEP**

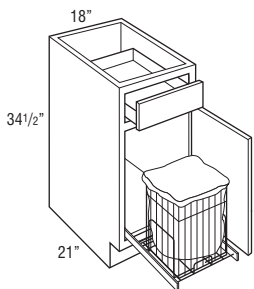

VBH183421 L or R

- Includes full extension removable chrome pull-out hamper with removable cloth liner.
- Hamper size is 19 3/8" high x 14 3/4" wide x 18" deep.

**Custom Modifications**

AUTH	CBO	CCO	CFNTO	CFP	CFRMO	CMAT	CND	DRWPWR	DRWTK	EXBK	EX	FB	FFD	FPEB	FTK	FTK_V	ID	INVFRM	LTI	MIP	RD	RECTK_	RT	TKP	TOTSSS	VTK	WLI	
		•																										

**Construction Upgrades**

APC	PE
•	•

**Door Options**

ALF	CG	DPSRR	MD	MFO
		•		

## LINEN TALL

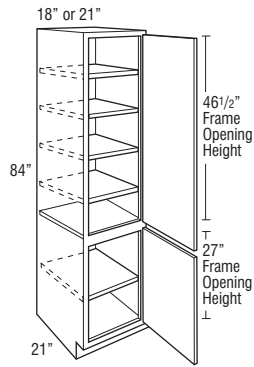

### LT188421 L or R

### LT218421 L or R

- Tall non-mitered doors will have two center panels with cross rail.
- Door 33 doors greater than 48" high will be two doors doweled together.
- Recommended for use with 34 1/2" high cabinets (bottom door will align with top of drawer front or top of full height door).

#### Custom Modifications

AUTH	CBO	CCO	CFNTO	CFP	CFRMO	CMAT	CND	DRWPWR	DRWTK	EXBK	EX	FB	FFD	FPEB	FTK	FTK_V	ID	INVFRM	LTI	MIP	RD	RECTK_	RT	TKP	TOTSSS	VTK	WLI
	•	•	•		•					•	•	•		•	•	•		•				•*	•	•		•	•

\*RECTKALL and RECTKBK not available

#### Construction Upgrades

APC	PE
•	•

#### Door Options

ALF	CG	DPSRR	MD	MFO
		•		•

## LINEN CLOSET

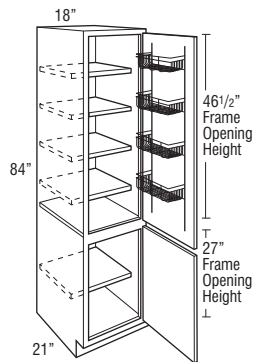

### LC188421 L or R

- Upper section features a 5" deep chrome door rack.
- 15" deep adjustable shelves indicated by light dotted lines are included; packaged separately.
- Tall non-mitered doors will have two center panels with cross rail.
- Door 33 doors greater than 48" high will be two doors doweled together.
- Recommended for use with 34 1/2" high cabinets (bottom door will align with top of drawer front or top of full height door).

#### Custom Modifications

AUTH	CBO	CCO	CFNTO	CFP	CFRMO	CMAT	CND	DRWPWR	DRWTK	EXBK	EX	FB	FFD	FPEB	FTK	FTK_V	ID	INVFRM	LTI	MIP	RD	RECTK_	RT	TKP	TOTSSS	VTK	WLI
	•	•	•		•					•	•			•	•	•		•				•*	•	•		•	•

\*RECTKALL and RECTKBK not available

#### Construction Upgrades

APC	PE
•	•

#### Door Options

ALF	CG	DPSRR	MD	MFO
		•		•

## LINEN CLOSET with REMOVABLE HAMPER

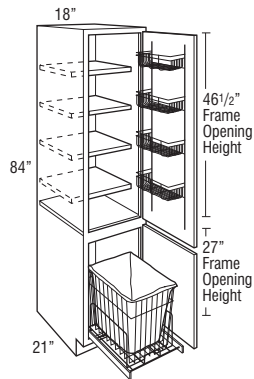

### LCRH188421 L or R

- Upper section features a 5" deep chrome door rack.
- 15" deep adjustable shelves indicated by light dotted lines are included; packaged separately.
- Includes full extension removable chrome pull-out hamper with removable cloth liner.
- Hamper size is 19 3/8" high x 14 3/4" wide x 18" deep.
- Tall non-mitered doors will have two center panels with cross rail.
- Door 33 doors greater than 48" high will be two doors doweled together.
- Recommended for use with 34 1/2" high cabinets (bottom door will align with top of drawer front or top of full height door).

#### Custom Modifications

AUTH	CBO	CCO	CFNTO	CFP	CFRMO	CMAT	CND	DRWPWR	DRWTK	EXBK	EX	FB	FFD	FPEB	FTK	FTK_V	ID	INVFRM	LTI	MIP	RD	RECTK_	RT	TKP	TOTSSS	VTK	WLI
	•	•	•		•					•	•			•	•	•		•				•*	•	•		•	•

\*RECTKALL and RECTKBK not available

#### Construction Upgrades

APC	PE
•	•

#### Door Options

ALF	CG	DPSRR	MD	MFO
		•		•

**LINEN TALL with DRAWER**

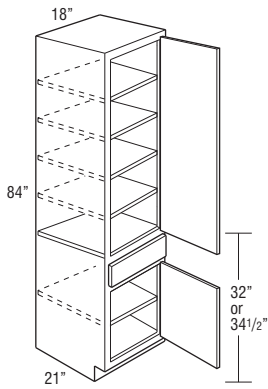

**LTD188421 L or R**  
**LTD188421BH L or R**

- Tall non-mitered doors will have two center panels with cross rail.
- Door 33 doors greater than 48" high will be two doors doweled together.
- LTD188421 designed to be used with 32" high vanities.
- LTD188421BH designed to be used with 34 1/2" high vanities.

**Custom Modifications**

AUTH	CBO	CCO	CFNTO	CFP	CFRMO	CMAT	CND	DRWPWR	DRWTK	EXBK	EX	FB	FFD	FPEB	FTK	FTK_V	ID	INVFRM	LTI	MIP	RD	RECTK_	RT	TKP	TOTSSS	VTK	WLL
•	•	•	•	•	•	•	•	•	•	•	•	•	•	•	•	•	•	•	•	•	•	•*	•	•	•	•	•

\*RECTKALL and RECTKBK not available

**Construction Upgrades**

APC	PE
•	•

**Door Options**

ALF	CG	DPSRR	MD	MFO
•	•	•	•	•

**LINEN TALL with DRAWER and REMOVABLE HAMPER**

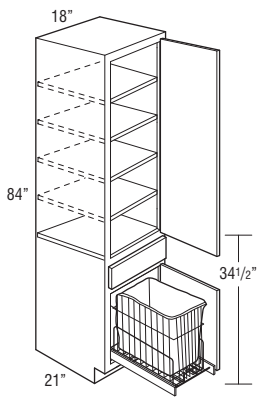

**L188421BH L or R**

- Tall non-mitered doors will have two center panels with cross rail.
- Door 33 doors greater than 48" high will be two doors doweled together.
- L188421BH is designed to be used with 34 1/2" high vanities and includes a full extension removable chrome pull-out hamper with removable cloth liner. Hamper size is 19 3/8" high x 14 3/4" wide x 18" deep.

**Custom Modifications**

AUTH	CBO	CCO	CFNTO	CFP	CFRMO	CMAT	CND	DRWPWR	DRWTK	EXBK	EX	FB	FFD	FPEB	FTK	FTK_V	ID	INVFRM	LTI	MIP	RD	RECTK_	RT	TKP	TOTSSS	VTK	WLL
•	•	•	•	•	•	•	•	•	•	•	•	•	•	•	•	•	•	•	•	•	•	•*	•	•	•	•	•

\*RECTKALL and RECTKBK not available

**Construction Upgrades**

APC	PE
•	•

**Door Options**

ALF	CG	DPSRR	MD	MFO
•	•	•	•	•

**VANITY UTILITY, 84" TALL, 21" DEEP**

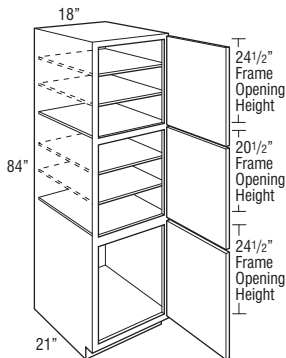

**VU188421 L or R**

- Lower door section is drilled to accept adjustable shelf.
- Shelves indicated by light dotted lines are included; packaged separately.
- Shelves indicated by solid lines are fixed.
- Vanity utilities designed to be used with 32" tall vanities.

**Custom Modifications**

AUTH	CBO	CCO	CFNTO	CFP	CFRMO	CMAT	CND	DRWPWR	DRWTK	EXBK	EX	FB	FFD	FPEB	FTK	FTK_V	ID	INVFRM	LTI	MIP	RD	RECTK_	RT	TKP	TOTSSS	VTK	WLL
•	•	•	•	•	•	•	•	•	•	•	•	•	•	•	•	•	•	•	•	•	•	•*	•	•	•	•	•

\*RECTKALL and RECTKBK not available

**Construction Upgrades**

APC	PE
•	•

**Door Options**

ALF	CG	DPSRR	MD	MFO
•	•	•	•	•

**VANITY WALL HUNG TWO DRAWER SINK BASE with FALSE PANEL, 23 1/2" HIGH, 21" DEEP**

24", 27", 30", 33", or 36"

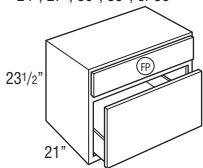

- VWH2D2423.521FP
- VWH2D2723.521FP
- VWH2D3023.521FP
- VWH2D3323.521FP
- VWH2D3623.521FP

- Plumbing clearance of 15 1/16" to the top edge of the lower drawer box (6 3/8" high drawer box).
- 5-piece drawer front configuration will not match on door styles with unique rail widths for drawer fronts over 10" high. Check door style section on pages 10-24 for drawer rail widths by height.
- Features a full cabinet top that can be routed for sink installation.
- Standard with All-plywood Construction (APC) and Furniture Finished Plywood Ends (FPFB).
- Installation to be performed by qualified professionals only.
- Unit must be securely fastened with sufficient type, quantity and size of screws to all available wall studs and internal structural wall blocking placed between wall studs. Additional bracing may be required.
- Installation instructions and required 3 1/2" installation screws included, standard 2 1/2" installation screws are not sufficient in this application.
- The use of internal structural wall blocking (2 x 6's) is required to provide secure horizontal attachment points between wall studs.
- Do not exceed loading of 25 lbs./sq. ft. for countertop and sink.
- Do not exceed loading of 15 lbs./sq. ft. for contents on shelves and/or drawers.
- Avoid use of concrete or other heavy masonry countertops.

**Custom Modifications**

AUTH	CBO	CCO	CFNTO	CFP	CFRMO	CMAT	CND	DRWPWR	DRWTK	EXBK	EX	FB	FFD	FPFB	FTK	FTK_V	ID	INVFRM	LTI	MIP	RD	RECTK_	RT	TKP	TOTSSS	VTK	WLI
•	•	•			STD	•					•			STD								•					

**Construction Upgrades**

APC	PE
STD	

**Door Options**

ALF	CG	DPSRR	MD	MFO

**VANITY WALL HUNG TWO DRAWER BASE, 23 1/2" HIGH, 21" DEEP**

24", 27", 30", 33", or 36"

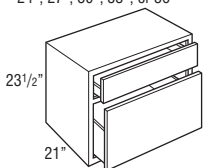

- VWH2D2423.521
- VWH2D2723.521
- VWH2D3023.521
- VWH2D3323.521
- VWH2D3623.521

- Top drawer box is 3 3/8" high, bottom drawer box is 10" high.
- Cannot be used with a sink due to drawer interference.
- 5-piece drawer front configuration will not match on door styles with unique rail widths for drawer fronts over 10" high. Check door style section on pages 10-24 for drawer rail widths by height.
- Features a full cabinet top.
- Standard with All-plywood Construction (APC) and Furniture Finished Plywood Ends (FPFB).
- Installation to be performed by qualified professionals only.
- Unit must be securely fastened with sufficient type, quantity and size of screws to all available wall studs and internal structural wall blocking placed between wall studs. Additional bracing may be required.
- Installation instructions and required 3 1/2" installation screws included, standard 2 1/2" installation screws are not sufficient in this application.
- The use of internal structural wall blocking (2 x 6's) is required to provide secure horizontal attachment points between wall studs.
- Do not exceed loading of 25 lbs./sq. ft. for countertop and sink.
- Do not exceed loading of 15 lbs./sq. ft. for contents on shelves and/or drawers.
- Avoid use of concrete or other heavy masonry countertops.

**Custom Modifications**

AUTH	CBO	CCO	CFNTO	CFP	CFRMO	CMAT	CND	DRWPWR	DRWTK	EXBK	EX	FB	FFD	FPFB	FTK	FTK_V	ID	INVFRM	LTI	MIP	RD	RECTK_	RT	TKP	TOTSSS	VTK	WLI
•	•	•		•	•			•			•			STD								•					

**Construction Upgrades**

APC	PE
STD	

**Door Options**

ALF	CG	DPSRR	MD	MFO

**VANITY WALL HUNG DOUBLE DOOR**  
with U-SHAPED PULL-OUTS,  
23 1/2" HIGH, 21" DEEP

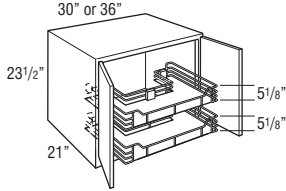

**VWH3023.521U**  
**VWH3623.521U**

- Includes two chrome U-shaped smart close pull-outs with non-slip gray shelf liner.
- Bottom pull-out cut-out for U-shape is 6 1/8" from back of cabinet and 15 3/4" wide.
- Top pull-out cut-out for U-shape is 12 1/8" from back of cabinet and 15 3/4" wide.
- VWH3023.521U pull-outs are 25 1/4" wide and 17" deep.
- VWH3623.521U pull-outs are 31 1/4" wide and 17" deep.
- Features a full cabinet top that can be routed for sink installation.
- Standard with All-plywood Construction (APC) and Furniture Finished Plywood Ends (FPPEB).
- Installation to be performed by qualified professionals only.
- Unit must be securely fastened with sufficient type, quantity and size of screws to all available wall studs and internal structural wall blocking placed between wall studs. Additional bracing may be required.
- Installation instructions and required 3 1/2" installation screws included, standard 2 1/2" installation screws are not sufficient in this application.
- The use of internal structural wall blocking (2 x 6's) is required to provide secure horizontal attachment points between wall studs.
- Do not exceed loading of 25 lbs./sq. ft. for countertop and sink.
- Do not exceed loading of 15 lbs./sq. ft. for contents on shelves and/or drawers.
- Avoid use of concrete or other heavy masonry countertops.

**Custom Modifications**

AUTH	CBO	CCO	CFNTO	CFP	CFRMO	CMAT	CND	DRWPWR	DRWTK	EXBK	EX	FB	FFD	FPEB	FTK	FTK_V	ID	INVFRM	LTI	MIP	RD	RECTK_	RT	TKP	TOTSSS	VTK	WLI
•	•	•	•	•	•						•			STD						•	•						•

**Construction Upgrades**

APC	PE
STD	

**Door Options**

ALF	CG	DPSRR	MD	MFO
		•		

**VANITY WALL HUNG SINGLE DOOR,**  
23 1/2" HIGH, 21" DEEP

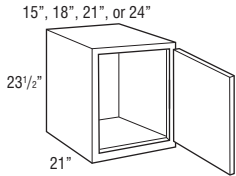

**VWH1523.521 L or R**  
**VWH1823.521 L or R**  
**VWH2123.521 L or R**  
**VWH2423.521 L or R**

- Features a full cabinet top that can be routed for sink installation.
- Standard with All-plywood Construction (APC) and Furniture Finished Plywood Ends (FPPEB).
- Installation to be performed by qualified professionals only.
- Unit must be securely fastened with sufficient type, quantity and size of screws to all available wall studs and internal structural wall blocking placed between wall studs. Additional bracing may be required.
- Installation instructions and required 3 1/2" installation screws included, standard 2 1/2" installation screws are not sufficient in this application.
- The use of internal structural wall blocking (2 x 6's) is required to provide secure horizontal attachment points between wall studs.
- Do not exceed loading of 25 lbs./sq. ft. for countertop and sink.
- Do not exceed loading of 15 lbs./sq. ft. for contents on shelves and/or drawers.
- Avoid use of concrete or other heavy masonry countertops.

**Custom Modifications**

AUTH	CBO	CCO	CFNTO	CFP	CFRMO	CMAT	CND	DRWPWR	DRWTK	EXBK	EX	FB	FFD	FPEB	FTK	FTK_V	ID	INVFRM	LTI	MIP	RD	RECTK_	RT	TKP	TOTSSS	VTK	WLI
•	•	•	•	•	•						•			STD						•*	•	•		•			•

\*Available only on 24" wide

**Construction Upgrades**

APC	PE
STD	

**Door Options**

ALF	CG	DPSRR	MD	MFO
		•		



**VANITY WALL HUNG DOUBLE DOOR, 23 1/2" HIGH, 21" DEEP**

24", 27", 30", 33", or 36"

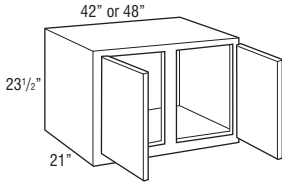
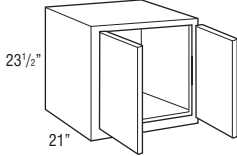

- VWH2423.521
- VWH2723.521
- VWH3023.521
- VWH3323.521
- VWH3623.521

**VWH4223.521  
VWH4823.521CS**

- Features a full cabinet top that can be routed for sink installation.
- Standard with All-plywood Construction (APC) and Furniture Finished Plywood Ends (FPFB).
- Installation to be performed by qualified professionals only.
- Unit must be securely fastened with sufficient type, quantity and size of screws to all available wall studs and internal structural wall blocking placed between wall studs. Additional bracing may be required.
- Installation instructions and required 3 1/2" installation screws included, standard 2 1/2" installation screws are not sufficient in this application.
- The use of internal structural wall blocking (2 x 6's) is required to provide secure horizontal attachment points between wall studs.
- Do not exceed loading of 25 lbs./sq. ft. for countertop and sink.
- Do not exceed loading of 15 lbs./sq. ft. for contents on shelves and/or drawers.
- Avoid use of concrete or other heavy masonry countertops.

**Custom Modifications**

AUTH	CBO	CCO	CFNTO	CFP	CFRMO	CMAT	CND	DRWPWR	DRWTK	EXBK	EX	FB	FFD	FPFB	FTK	FTK_V	ID	INVFRM	LTI	MIP	RD	RECTK_	RT	TKP	TOTSSS	VTK	WLI
•		•	•		•									STD						•	•	•		•			•

**Construction Upgrades**

APC	PE
STD	

**Door Options**

ALF	CG	DPSRR	MD	MFO
		•		

**VANITY WALL CUBBY**

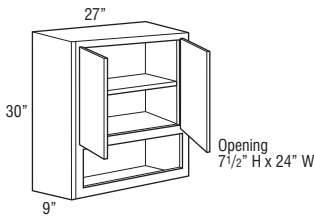

**VWC2730**

- Includes 1 adjustable shelf.
- Matching Interior Plywood (MIP) standard.

**Custom Modifications**

AUTH	CBO	CCO	CFNTO	CFP	CFRMO	CMAT	CND	DRWPWR	DRWTK	EXBK	EX	FB	FFD	FPFB	FTK	FTK_V	ID	INVFRM	LTI	MIP	RD	RECTK_	RT	TKP	TOTSSS	VTK	WLI
•		•	•	•	•					•	•			•							STD						•

**Construction Upgrades**

APC	PE

**Door Options**

ALF	CG	DPSRR	MD	MFO
		•	•	

**VANITY WALL, 30" HIGH, 6" DEEP**

12", 15", 18", or 24"

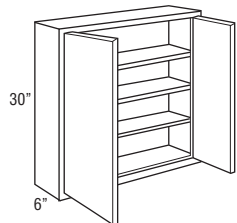
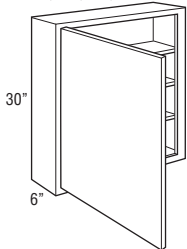

- W12306 L or R
- W15306 L or R
- W18306 L or R
- W24306 L or R

**W24306**

**Custom Modifications**

AUTH	CBO	CCO	CFNTO	CFP	CFRMO	CMAT	CND	DRWPWR	DRWTK	EXBK	EX	FB	FFD	FPFB	FTK	FTK_V	ID	INVFRM	LTI	MIP	RD	RECTK_	RT	TKP	TOTSSS	VTK	WLI
		•	•	•	•									•							•						•

**Construction Upgrades**

APC	PE
•	•

**Door Options**

ALF	CG	DPSRR	MD	MFO
• <sup>†</sup>	•	•	• <sup>‡</sup>	•

<sup>†</sup>Not available on 24" wide

<sup>‡</sup>Not available on 12" wide

**VANITY WALL MIRROR CABINET,  
30" HIGH, 4 9/16" DEEP**

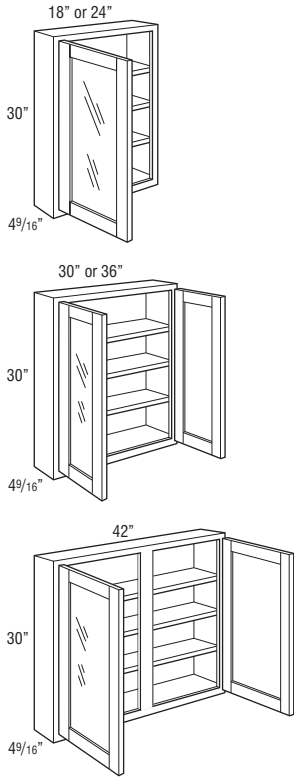

**VWM1830 L or R**  
**VWM2430 L or R**

**VWM3030**  
**VWM3630**

**VWM4230**

- Standard with CG doors and installed mirror glass.
- Unit intended to be surface mounted. Features standard 1/4" face frame reveal on ends.
- Not available in Door 19, Door 25, Door 33, Door 36, Door 37, and Door 44 styles.
- Adjustable shelves.

**Custom Modifications**

AUTH	CBO	CCO	CFNTO	CFP	CFRMO	CMAT	CND	DRWPWR	DRWTK	EXBK	EX	FB	FFD	FPEB	FTK	FTK_V	ID	INVFRM	LTI	MIP	RD	RECTK_	RT	TKP	TOTSSS	VTK	WLI
		•	•	•	•					•	•	•		•						•							•

**Construction Upgrades**

APC	PE
•	•

**Door Options**

ALF	CG	DPSRR	MD	MFO
	•			
	STD			

**VANITY MIRROR with SIDE  
PULL-OUTS, 32 1/2" HIGH,  
4 7/8" DEEP**

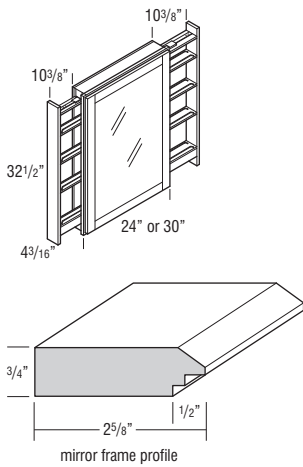

**VMP2432.5**  
**VMP3032.5**

- One full extension natural wood finish pull-out on each side with three adjustable shelves and chrome rail sides (smart close not included).
- Pull-outs extend 10 3/8" on each side. VMP2432.5 open width is 44 3/4". VMP3032.5 open width is 50 3/4".
- Mirror frame has a shaker outside profile and a bevel inside profile with a 1/4" face frame reveal. Mirror is not removable.
- Mirror visible dimensions:  
VMP2432.5 - 26 3/4" high x 18 1/4" wide  
VMP3032.5 - 26 3/4" high x 24 1/4" wide
- Installation instructions included.
- When Distressing is selected, only fillers will receive treatment.
- When Heirlooming is selected, only mirror frame will receive treatment.
- Pull-outs feature plain fillers. If a more decorative look is desired, overlay fillers may be ordered separately and field installed.

**MODIFICATIONS**

No modifications available for these products.

**Finish Techniques**

Distressing	Heirlooming
•	•

**Species Availability (Wood)**

Rustic Alder	Rustic Alder	Cherry	Rustic Hickory	Maple	Oak
		•		•	

**Species Availability (All Laminates)**

High Gloss	Horiz. Grain on Maple	Vert. Grain on Maple	Vert. Grain on Cherry	Vert. Grain on Oak
box color	box color	box color	box color	

**VANITY MIRROR**

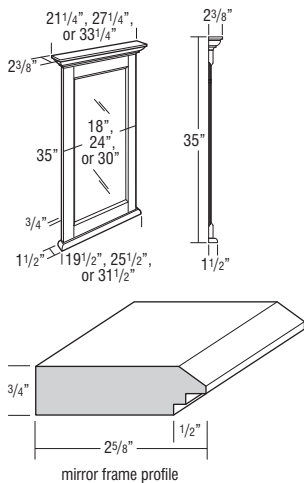

**VM2135**

**VM2735**

**VM3335**

- Moulding included on vanity mirror is not a standard moulding. SWLCRM8 is similar.
- Mirror glass is beveled.
- Includes two installed metal hanging hooks on back.

Model	Overall Dimensions		Mirror - Visible Dimensions	
	Width	Height	Width	Height
VM2135	21 1/4"	35"	12 15/16"	26 15/16"
VM2735	27 1/4"	35"	18 15/16"	26 15/16"
VM3335	33 1/4"	35"	24 15/16"	26 15/16"

MODIFICATIONS
No modifications available for these products.

Finish Techniques	
Distressing	Heirloom
	•

**Species Availability (Wood)**

	Rustic Alder	Cherry	Rustic Hickory	Maple	Oak
		•		•	

**Species Availability (All Laminates)**

	High Gloss box color	Horiz. Grain on Maple box color	Vert. Grain on Maple box color	Vert. Grain on Cherry box color	Vert. Grain on Oak box color

**SINGLE DOOR MEDICINE CABINET**

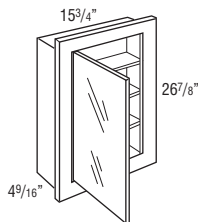

**MC16**

- Unit can be surface mounted or recessed.
- Door of cabinet is glass mirror, 12 5/8" wide x 23 1/2" high.
- Matching cabinet doors not available.
- Cabinet has wood frame.
- Finished exterior.
- Standard interior.
- If ordered with Heirloom Technique, will not feature sand-through characteristics.

Model	Cabinet Dimensions			Cut-out Dimensions		
	Width	Height	Depth	Width	Height	Depth
MC16	15 3/4"	26 7/8"	4 9/16"	14 7/16"	25 5/8"	4"

**Custom Modifications**

AUTH	CBO	CCO	CFNTO	CFP	CFRMO	CMAT	CND	DRWPWR	DRWTK	EXBK	EX	FB	FFD	FPEB	FTK	FTK_V	ID	INFRM	LTI	MIP	RD	RECTK_	RT	TKP	TOTSSS	VTK	WLI	
	•	•	•	•								STD									•							•

**Construction Upgrades**

APC	PE
STD	

**Door Options**

ALF	CG	DPSRR	MD	MFO

**TRI-VIEW MEDICINE CABINET**

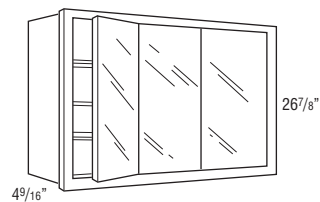

**TV30**

**TV36**

**TV48**

- Cabinet has wood frame.
- Door of cabinet is glass mirror.
- Unit can be surface mounted or recessed.
- Finished exterior.
- Standard interior.
- If ordered with Heirloom Technique, will not feature sand-through characteristics.

Model	Cabinet Dimensions			Cut-out Dimensions		
	Width	Height	Depth	Width	Height	Depth
TV30	30"	26 7/8"	4 9/16"	28 11/16"	25 5/8"	4"
TV36	36"	26 7/8"	4 9/16"	34 11/16"	25 5/8"	4"
TV48	48"	26 7/8"	4 9/16"	46 11/16"	25 5/8"	4"

**Custom Modifications**

AUTH	CBO	CCO	CFNTO	CFP	CFRMO	CMAT	CND	DRWPWR	DRWTK	EXBK	EX	FB	FFD	FPEB	FTK	FTK_V	ID	INFRM	LTI	MIP	RD	RECTK_	RT	TKP	TOTSSS	VTK	WLI	
	•	•	•	•								STD									•							•

**Construction Upgrades**

APC	PE
STD	

**Door Options**

ALF	CG	DPSRR	MD	MFO

**SPECIES AVAILABILITY**

Species Availability charts list the availability of each product code by species and any substitutions that are made. Exceptions within a section are noted below the species availability chart.

For panels with doors and/or fillers attached, species availability is shown for the panel and filler only.

For Species Availability, look for this chart throughout. For trim items ordered with Laminates, trim items matching the cabinet box color are noted in the charts.

MDF door styles will use Maple for trim and panels, refer to Maple in the Species Availability charts.

**Species Availability (Wood)**

Rustic Alder	Cherry	Rustic Hickory	Maple	Oak
• Alder	•	• Hickory	•	•

**Species Availability (All Laminates)**

High Gloss	Horiz. Grain on Maple	Vert. Grain on Maple	Vert. Grain on Cherry	Vert. Grain on Oak
box color	box color	box color	box color	box color

**DESCRIPTION MODEL**  
**FILLERS**

**3" WIDE FILLERS**

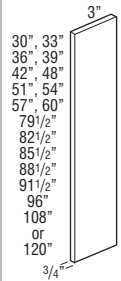

F3



F330

F333

F336

F339

F342

F348

F351

F354

F357

F360

TF384

TF387

TF390

TF393

TF396

TF396FH

TF3108FH† ♦

TF3120FH† ♦

- 3/4" thick.
- Finished on front and all edges (backs are not finished).
- †5 day Express Response not available.

**Finish Techniques**

Distressing	Heirlooming
•	

**Species Availability (Wood)**

Rustic Alder	Cherry	Rustic Hickory	Maple	Oak
• Alder	•	• Hickory	•	•

♦ Only available in Cherry and Maple.

**Species Availability (All Laminates)**

High Gloss	Horiz. Grain on Maple	Vert. Grain on Maple	Vert. Grain on Cherry	Vert. Grain on Oak
box color	box color	box color	box color	box color

♦ Only available in Cherry and Maple box colors.

**3" WIDE FILLER RETURN**

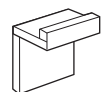

F3R



F3R

- Creates a toekick appearance when used with 3" wide fillers.
- 3/8" thick, Natural Maple laminated furniture board.

**DESCRIPTION**

**3" WIDE CORNER FILLER**

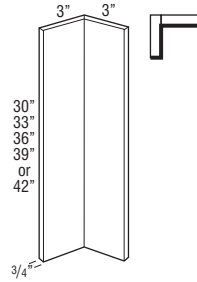

CF3



**MODEL**

CF330

CF333

CF336

CF339

CF342

- 3/4" thick.
- Finished on front and all edges (backs are not finished).

**Finish Techniques**

Distressing	Heirlooming
•	

**Species Availability (Wood)**

Rustic Alder	Cherry	Rustic Hickory	Maple	Oak
• Alder	•	• Hickory	•	•

**Species Availability (All Laminates)**

High Gloss	Horiz. Grain on Maple	Vert. Grain on Maple	Vert. Grain on Cherry	Vert. Grain on Oak
box color	box color	box color	box color	box color

**6" WIDE FILLERS**

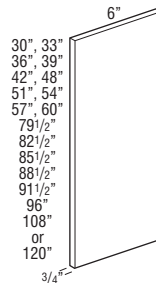

F6



F630

F633

F636

F639

F642

F648

F651

F654

F657

F660

TF684

TF687

TF690

TF693

TF696

TF696FH

TF6108FH† ♦

TF6120FH† ♦

- 3/4" thick.
- Finished on front and all edges (backs are not finished).
- †5 day Express Response not available.

**Finish Techniques**

Distressing	Heirlooming
•	

**Species Availability (Wood)**

Rustic Alder	Cherry	Rustic Hickory	Maple	Oak
• Alder	•	• Hickory	•	•

♦ Only available in Cherry and Maple.

**Species Availability (All Laminates)**

High Gloss	Horiz. Grain on Maple	Vert. Grain on Maple	Vert. Grain on Cherry	Vert. Grain on Oak
box color	box color	box color	box color	box color

♦ Only available in Cherry and Maple box colors.

**6" WIDE FILLER RETURN**

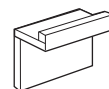

F6R



F6R

- Creates a toekick appearance when used with 6" wide fillers.
- 3/8" thick, Natural Maple laminated furniture board.

Finished edges indicated by bold lines on side view drawings.  
Glazed edges indicated by arrows on side view drawings.

**DESCRIPTION**

**MODEL**

**SPACE FILLERS**



**S96X14** (1/4" thick)

**S96X12** (1/2" thick)

- S96 is 1/4" or 1/2" thick.
- Designed to fill space between adjacent cabinets; i.e. W1830 butted against side of U188424.
- Finished on front and all edges (backs are not finished).

**Finish Techniques**

Distressing	Heirlooming

**Species Availability (Wood)**

Rustic Alder	Rustic Alder	Cherry	Rustic Hickory	Maple	Oak
• Alder		•	• Hickory	•	•

**Species Availability (All Laminates)**

High Gloss	Horiz. Grain on Maple	Vert. Grain on Maple	Vert. Grain on Cherry	Vert. Grain on Oak
box color	box color	box color	box color	box color

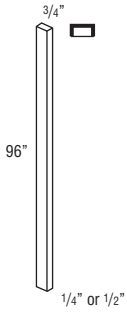

**DESCRIPTION**

**MODEL**

**OVERLAY FILLER for MODIFIED FULL OVERLAY, 2 1/2" WIDE**



**OL312MFO** (10 3/4"H)

**OL315MFO** (13 3/4"H)

**OL318MFO** (16 3/4"H)

**OL321MFO** (19 3/4"H)

**OL324MFO** (22 3/4"H)

**OL327MFO** (25 3/4"H)

**OL330MFO** (28 3/4"H)

**OL333MFO** (31 3/4"H)

**OL336MFO** (34 3/4"H)

**OL339MFO** (37 3/4"H)

**OL342MFO** (40 3/4"H)

**OL384MFO** (78 1/4"H)

**OL387MFO** (81 1/4"H)

**OL390MFO** (84 1/4"H)

**OL393MFO** (87 1/4"H)

**OL396MFO** (90 1/4"H)

- All overlay fillers available in full overlay door styles except Door 37 and Door 44.
- Height will align with doors specified with Modified Full Overlay modification. See page 42 for MFO details.
- 2 1/2" wide overlay fillers can be applied to Wall Message Centers to create a custom finished look.
- Overlays match door profile and thickness.
- Finished on front and all edges (backs are not finished).
- Not available in Door 15, Door 18, and Door 32 MDF door styles.

**Finish Techniques**

Distressing	Heirlooming
•	•

**Species Availability (Wood)**

Rustic Alder	Rustic Alder	Cherry	Rustic Hickory	Maple	Oak
• Alder		•	• Hickory	•	•

**Species Availability (All Laminates)**

High Gloss	Horiz. Grain on Maple	Vert. Grain on Maple	Vert. Grain on Cherry	Vert. Grain on Oak

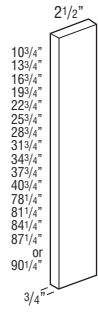

**OVERLAY FILLER, 2 1/2" WIDE**



**OL312** (11 1/2"H)

**OL315** (14 1/2"H)

**OL318** (17 1/2"H)

**OL321** (20 1/2"H)

**OL324** (23 1/2"H)

**OL327** (26 1/2"H)

**OL330** (28"H or 29 1/2"H)

**OL333** (31"H or 32 1/2"H)

**OL336** (34"H or 35 1/2"H)

**OL339** (37"H or 38 1/2"H)

**OL342** (40"H or 41 1/2"H)

**OL384** (79"H)

**OL387** (82"H)

**OL390** (85"H)

**OL393** (88"H)

**OL396** (91"H)

**VOL332** (27"H)

**DOL329** (24"H)

- All overlay fillers available in full overlay door styles.
- 2 1/2" wide overlay fillers can be applied to Wall Message Centers to create custom finished look.
- Overlays match door profile and thickness.
- See pages 6-7 for list of full overlay styles.
- Finished on front and all edges (backs are not finished).
- See OL\_\_MFO (on right) for use with Modified Full Overlay modification.
- Maple will be used for MDF overlays.

**Finish Techniques**

Distressing	Heirlooming
•	•

**Species Availability (Wood)**

Rustic Alder	Rustic Alder	Cherry	Rustic Hickory	Maple	Oak
• Alder		•	• Hickory	•	•

**Species Availability (All Laminates)**

High Gloss	Horiz. Grain on Maple	Vert. Grain on Maple	Vert. Grain on Cherry	Vert. Grain on Oak

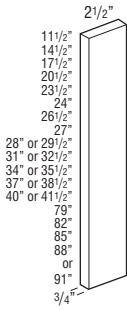

Finished edges indicated by bold lines on side view drawings.  
Glazed edges indicated by arrows on side view drawings.

**DESCRIPTION**

**MODEL**

**OVERLAY FILLER, PREMIUM, 2 1/2" WIDE**

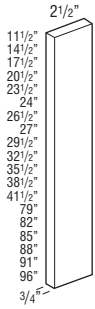

- OL312P** (11 1/2"H)
- OL315P** (14 1/2"H)
- OL318P** (17 1/2"H)
- OL321P** (20 1/2"H)
- OL324P** (23 1/2"H)
- OL327P** (26 1/2"H)
- OL330P** (29 1/2"H)
- OL333P** (32 1/2"H)
- OL336P** (35 1/2"H)
- OL339P** (38 1/2"H)
- OL342P** (41 1/2"H)
- OL384P** (79"H)
- OL387P** (82"H)
- OL390P** (85"H)
- OL393P** (88"H)
- OL396P** (91"H)
- OL396FHP** (96"H)
- VOL332P** (27"H)
- DOL329P** (24"H)

- Overlays match door profile and thickness.
- Front, edges, and backs match door and drawer front construction.
- Door 25 edgebanding will match door and drawer front edgebanding selection.
- Door 33 overlays feature horizontal grain. Overlays greater than 48" high will be two overlays and require field assembly (allow 3/16" gap between overlays for alignment with adjacent doors).

**Finish Techniques**

Distressing	Heirlooming
-------------	-------------

**Species Availability (Wood)**

	Rustic		Rustic		
Alder	Alder	Cherry	Hickory	Maple	Oak

**Species Availability (All Laminates)**

High Gloss	Horiz. Grain on Maple	Vert. Grain on Maple	Vert. Grain on Cherry	Vert. Grain on Oak
•	•	•	•	•

**DESCRIPTION**

**MODEL**

**OVERLAY FILLER for MODIFIED FULL OVERLAY, PREMIUM, 2 1/2" WIDE**

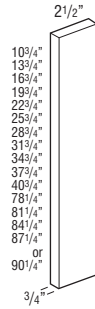

- OL312MFOP** (10 3/4"H)
- OL315MFOP** (13 3/4"H)
- OL318MFOP** (16 3/4"H)
- OL321MFOP** (19 3/4"H)
- OL324MFOP** (22 3/4"H)
- OL327MFOP** (25 3/4"H)
- OL330MFOP** (28 3/4"H)
- OL333MFOP** (31 3/4"H)
- OL336MFOP** (34 3/4"H)
- OL339MFOP** (37 3/4"H)
- OL342MFOP** (40 3/4"H)
- OL384MFOP** (78 1/4"H)
- OL387MFOP** (81 1/4"H)
- OL390MFOP** (84 1/4"H)
- OL393MFOP** (87 1/4"H)
- OL396MFOP** (90 1/4"H)

- Overlays match door profile and thickness.
- Front, edges, and backs match door and drawer front construction.
- Height will align with doors specified with Modified Full Overlay modification. See page 42 for MFO details.
- Door 25 edgebanding will match door and drawer front edgebanding selection.
- Door 33 overlays feature horizontal grain. Overlays greater than 48" high will be two overlays and require field assembly (allow 3/16" gap between overlays for alignment with adjacent doors).

**Finish Techniques**

Distressing	Heirlooming
-------------	-------------

**Species Availability (Wood)**

	Rustic		Rustic		
Alder	Alder	Cherry	Hickory	Maple	Oak

**Species Availability (All Laminates)**

High Gloss	Horiz. Grain on Maple	Vert. Grain on Maple	Vert. Grain on Cherry	Vert. Grain on Oak
•	•	•	•	•

**DESCRIPTION**

**OVERLAY FILLER,  
5 1/2" WIDE**

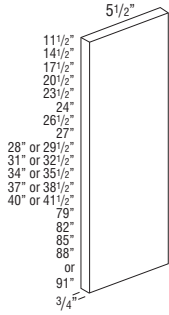

**MODEL**

- OL612** (11 1/2"H)
- OL615** (14 1/2"H)
- OL618** (17 1/2"H)
- OL621** (20 1/2"H)
- OL624** (23 1/2"H)
- OL627** (26 1/2"H)
- OL630** (28"H or 29 1/2"H)
- OL633** (31"H or 32 1/2"H)
- OL636** (34"H or 35 1/2"H)
- OL639** (37"H or 38 1/2"H)
- OL642** (40"H or 41 1/2"H)
- OL684** (79"H)
- OL687** (82"H)
- OL690** (85"H)
- OL693** (88"H)
- OL696** (91"H)
- VOL632** (27"H)
- DOL629** (24"H)

- All overlay fillers available in full overlay door styles.
- Overlays match door profile and thickness.
- See pages 6-7 for list of full overlay styles.
- Finished on front and all edges (backs are not finished).
- See OL\_\_MFO (on right) for use with Modified Full Overlay modification.
- Maple will be used for MDF overlays.

**Finish Techniques**

Distressing	Heirlooming
•	•

**Species Availability (Wood)**

	Rustic Alder	Cherry	Rustic Hickory	Maple	Oak
• Alder		•	Hickory	•	•

**Species Availability (All Laminates)**

High Gloss	Horiz. Grain on Maple	Vert. Grain on Maple	Vert. Grain on Cherry	Vert. Grain on Oak

**DESCRIPTION**

**OVERLAY FILLER  
for MODIFIED FULL  
OVERLAY, 5 1/2" WIDE**

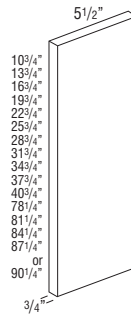

**MODEL**

- OL612MFO** (10 3/4"H)
- OL615MFO** (13 3/4"H)
- OL618MFO** (16 3/4"H)
- OL621MFO** (19 3/4"H)
- OL624MFO** (22 3/4"H)
- OL627MFO** (25 3/4"H)
- OL630MFO** (28 3/4"H)
- OL633MFO** (31 3/4"H)
- OL636MFO** (34 3/4"H)
- OL639MFO** (37 3/4"H)
- OL642MFO** (40 3/4"H)
- OL684MFO** (78 1/4"H)
- OL687MFO** (81 1/4"H)
- OL690MFO** (84 1/4"H)
- OL693MFO** (87 1/4"H)
- OL696MFO** (90 1/4"H)

- All overlay fillers available in full overlay door styles except Door 37 and Door 44.
- Height will align with doors specified with Modified Full Overlay modification. See page 42 for MFO details.
- Overlays match door profile and thickness.
- Finished on front and all edges (backs are not finished).
- Not available in Door 15, Door 18, and Door 32 MDF door styles.

**Finish Techniques**

Distressing	Heirlooming
•	•

**Species Availability (Wood)**

	Rustic Alder	Cherry	Rustic Hickory	Maple	Oak
• Alder		•	Hickory	•	•

**Species Availability (All Laminates)**

High Gloss	Horiz. Grain on Maple	Vert. Grain on Maple	Vert. Grain on Cherry	Vert. Grain on Oak

**DESCRIPTION**

**MODEL**

**OVERLAY FILLER, PREMIUM, 5 1/2" WIDE**

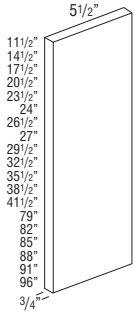

- OL612P** (11 1/2"H)
- OL615P** (14 1/2"H)
- OL618P** (17 1/2"H)
- OL621P** (20 1/2"H)
- OL624P** (23 1/2"H)
- OL627P** (26 1/2"H)
- OL630P** (29 1/2"H)
- OL633P** (32 1/2"H)
- OL636P** (35 1/2"H)
- OL639P** (38 1/2"H)
- OL642P** (41 1/2"H)
- OL684P** (79"H)
- OL687P** (82"H)
- OL690P** (85"H)
- OL693P** (88"H)
- OL696P** (91"H)
- OL696FHP** (96"H)
- VOL632P** (27"H)
- DOL629P** (24"H)

- Overlays match door profile and thickness.
- Front, edges, and backs match door and drawer front construction.
- Door 25 edgebanding will match door and drawer front edgebanding selection.
- Door 33 overlays feature horizontal grain. Overlays greater than 48" high will be two overlays and require field assembly (allow 3/16" gap between overlays for alignment with adjacent doors).

**Finish Techniques**

Distressing	Heirlooming
-------------	-------------

**Species Availability (Wood)**

	Rustic		Rustic		
Alder	Alder	Cherry	Hickory	Maple	Oak

**Species Availability (All Laminates)**

High Gloss	Horiz. Grain on Maple	Vert. Grain on Maple	Vert. Grain on Cherry	Vert. Grain on Oak
•	•	•	•	•

**DESCRIPTION**

**MODEL**

**OVERLAY FILLER for MODIFIED FULL OVERLAY, PREMIUM, 5 1/2" WIDE**

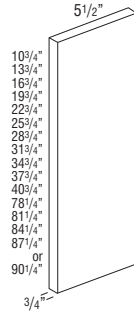

- OL612MFOP** (10 3/4"H)
- OL615MFOP** (13 3/4"H)
- OL618MFOP** (16 3/4"H)
- OL621MFOP** (19 3/4"H)
- OL624MFOP** (22 3/4"H)
- OL627MFOP** (25 3/4"H)
- OL630MFOP** (28 3/4"H)
- OL633MFOP** (31 3/4"H)
- OL636MFOP** (34 3/4"H)
- OL639MFOP** (37 3/4"H)
- OL642MFOP** (40 3/4"H)
- OL684MFOP** (78 1/4"H)
- OL687MFOP** (81 1/4"H)
- OL690MFOP** (84 1/4"H)
- OL693MFOP** (87 1/4"H)
- OL696MFOP** (90 1/4"H)

- Overlays match door profile and thickness.
- Front, edges, and backs match door and drawer front construction.
- Height will align with doors specified with Modified Full Overlay modification. See page 42 for MFO details.
- Door 25 edgebanding will match door and drawer front edgebanding selection.
- Door 33 overlays feature horizontal grain. Overlays greater than 48" high will be two overlays and require field assembly (allow 3/16" gap between overlays for alignment with adjacent doors).

**Finish Techniques**

Distressing	Heirlooming
-------------	-------------

**Species Availability (Wood)**

	Rustic		Rustic		
Alder	Alder	Cherry	Hickory	Maple	Oak

**Species Availability (All Laminates)**

High Gloss	Horiz. Grain on Maple	Vert. Grain on Maple	Vert. Grain on Cherry	Vert. Grain on Oak
•	•	•	•	•



**DESCRIPTION**

**FLUTED/BEADED 3" WIDE REVERSIBLE FILLERS**



**FBF330** (3" x 30")

**FBF336** (3" x 36")

**TBF396** (3" x 96")

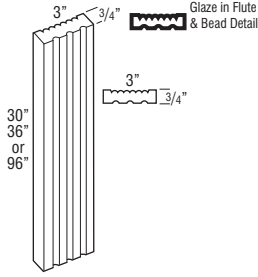

**Finish Techniques**

Distressing	Heirlooming
	•

**Species Availability (Wood)**

Rustic Alder	Cherry	Rustic Hickory	Maple	Oak
•	•	•	•	•

**Species Availability (All Laminates)**

High Gloss box color	Horiz. Grain on Maple box color	Vert. Grain on Maple box color	Vert. Grain on Cherry box color	Vert. Grain on Oak box color
----------------------	---------------------------------	--------------------------------	---------------------------------	------------------------------

**FLUTED/BEADED 6" WIDE REVERSIBLE FILLERS**



**FBF630** (6" x 30")

**FBF636** (6" x 36")

**TBF696** (6" x 96")

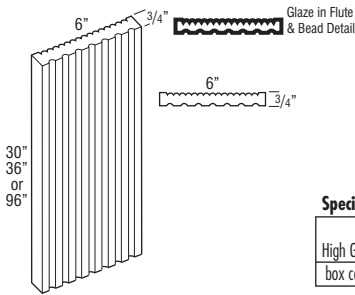

**Finish Techniques**

Distressing	Heirlooming
	•

**Species Availability (Wood)**

Rustic Alder	Cherry	Rustic Hickory	Maple	Oak
•	•	•	•	•

**Species Availability (All Laminates)**

High Gloss box color	Horiz. Grain on Maple box color	Vert. Grain on Maple box color	Vert. Grain on Cherry box color	Vert. Grain on Oak box color
----------------------	---------------------------------	--------------------------------	---------------------------------	------------------------------

**ANGLED FLUTED/PLAIN 3" WIDE REVERSIBLE FILLERS**



**BLVDF30** (3" x 30")

**BLVDF34.5** (3" x 34 1/2")

**BLVDTFF96** (3" x 96")

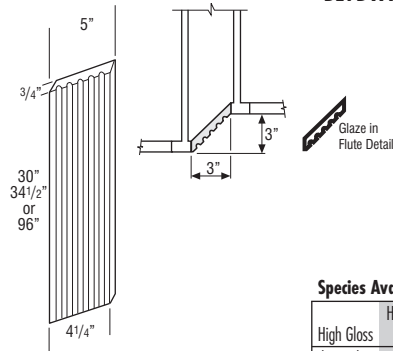

**Finish Techniques**

Distressing	Heirlooming
	•

**Species Availability (Wood)**

Rustic Alder	Cherry	Rustic Hickory	Maple	Oak
•	•	•	•	•

**Species Availability (All Laminates)**

High Gloss box color	Horiz. Grain on Maple box color	Vert. Grain on Maple box color	Vert. Grain on Cherry box color	Vert. Grain on Oak box color
----------------------	---------------------------------	--------------------------------	---------------------------------	------------------------------

**DESCRIPTION**

**BOX COLUMN FILLERS, 1 1/2" WIDE Wall - Plain Column 15" Deep**

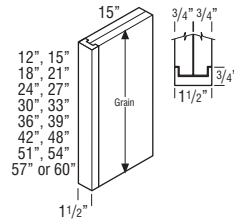

**Plain**

**MODEL**

- W1.512BCFP
- W1.515BCFP
- W1.518BCFP
- W1.521BCFP
- W1.524BCFP
- W1.527BCFP
- W1.530BCFP
- W1.533BCFP
- W1.536BCFP
- W1.539BCFP
- W1.542BCFP
- W1.548BCFP
- W1.551BCFP
- W1.554BCFP
- W1.557BCFP
- W1.560BCFP

- Available in 1" depth increments from 6" to 27".
- Reversible, may be used on either left or right end.
- Front and both sides finished. Top, bottom, and back are unfinished.
- Plywood construction.
- Finished veneer on end panel exterior.

**Custom Modifications**

ID	RD
•	•

**Finish Techniques**

Distressing	Heirlooming
•	•

**Species Availability (Wood)**

Rustic Alder	Cherry	Rustic Hickory	Maple	Oak
•	•	•	•	•

**Species Availability (All Laminates)**

High Gloss box color	Horiz. Grain on Maple box color	Vert. Grain on Maple box color	Vert. Grain on Cherry box color	Vert. Grain on Oak box color
----------------------	---------------------------------	--------------------------------	---------------------------------	------------------------------

Finished edges indicated by bold lines on side view drawings.  
Glazed edges indicated by arrows on side view drawings.

**DESCRIPTION**

**MODEL**

**BOX COLUMN FILLERS, 3" WIDE**  
**Wall - Plain Column**  
**15" Deep**

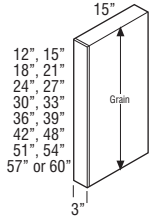

Plain

- W312BCFP
- W315BCFP
- W318BCFP
- W321BCFP
- W324BCFP
- W327BCFP
- W330BCFP
- W333BCFP
- W336BCFP
- W339BCFP
- W342BCFP
- W348BCFP
- W351BCFP
- W354BCFP
- W357BCFP
- W360BCFP

- Available in 1" depth increments from 6" to 27".
- Reversible, may be used on either left or right end.
- Front and both sides finished.
- Enclosed top and bottom (not finished).
- 1/2" plywood construction.
- Finished veneer on end panel exterior.
- No reveal on filler.
- Not intended for use horizontally as shelving. Use Floating Shelves on page 360.

Custom Modifications		Finish Techniques	
ID	RD	Distressing	Heirlooming
•	•	•	•

**Species Availability (Wood)**

	Rustic Alder	Cherry	Rustic Hickory	Maple	Oak
•	•	•	•	•	•

**Species Availability (All Laminates)**

	Horiz. Grain on Maple	Vert. Grain on Maple	Vert. Grain on Cherry	Vert. Grain on Oak
High Gloss	•	•	•	•
box color	•	•	•	•

**DESCRIPTION**

**MODEL**

**BOX COLUMN FILLERS, 3" WIDE**  
**Wall - Fluted, Beaded Column**  
**15" Deep**

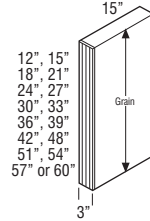

Fluted

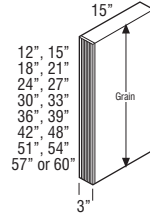

Beaded

- W312BCFF
- W315BCFF
- W318BCFF
- W321BCFF
- W324BCFF
- W327BCFF
- W330BCFF
- W333BCFF
- W336BCFF
- W339BCFF
- W342BCFF
- W348BCFF
- W351BCFF
- W354BCFF
- W357BCFF
- W360BCFF

- W312BCFB
- W315BCFB
- W318BCFB
- W321BCFB
- W324BCFB
- W327BCFB
- W330BCFB
- W333BCFB
- W336BCFB
- W339BCFB
- W342BCFB
- W348BCFB
- W351BCFB
- W354BCFB
- W357BCFB
- W360BCFB

- Available in 1" depth increments from 6" to 27".
- Reversible, may be used on either left or right end.
- Front and both sides finished.
- Enclosed top and bottom (not finished).
- 1/2" plywood construction.
- Finished veneer on end panel exterior.
- No reveal on filler.
- W3\_\_BCFF have Fluted fillers. W3\_\_BCFB have Beaded fillers.
- Not intended for use horizontally as shelving. Use Floating Shelves on page 360.

Custom Modifications		Finish Techniques	
ID	RD	Distressing	Heirlooming
•	•	•	•

**Species Availability (Wood)**

	Rustic Alder	Cherry	Rustic Hickory	Maple	Oak
•	•	•	•	•	•

**Species Availability (All Laminates)**

	Horiz. Grain on Maple	Vert. Grain on Maple	Vert. Grain on Cherry	Vert. Grain on Oak
High Gloss	•	•	•	•
box color	•	•	•	•

**DESCRIPTION**

**BOX COLUMN FILLERS,  
1 1/2" WIDE  
Base - Plain Column  
27" Deep**

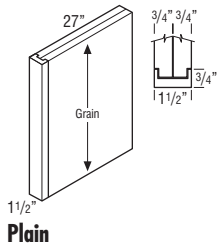

**Plain**

**MODEL**

**B1.534.527BCFP**

- Available in 1" depth increments from 6" to 27".
- Reversible, may be used on either left or right end.
- Front and both sides finished. Top, bottom, and back are unfinished.
- Plywood construction.
- Finished veneer on end panel exterior.

Custom Modifications		Finish Techniques	
ID	RD	Distressing	Heirlooming
	•	•	

**Species Availability (Wood)**

Rustic Alder	Rustic Alder	Cherry	Rustic Hickory	Maple	Oak
•	•	•	•	•	•

**Species Availability (All Laminates)**

High Glass	Horiz. Grain on Maple	Vert. Grain on Maple	Vert. Grain on Cherry	Vert. Grain on Oak
box color	box color	box color	box color	box color

**BOX COLUMN FILLERS, 3" WIDE  
Base - Plain Column  
27" Deep**

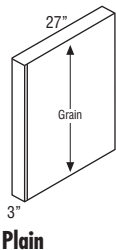

**Plain**

**B334.527BCFP**

- Available in 1" depth increments from 6" to 27".
- Reversible, may be used on either left or right end.
- Front and both sides finished.
- Enclosed top and bottom (not finished).
- 1/2" plywood construction.
- Finished veneer on end panel exterior.
- No reveal on filler.
- Not intended for use horizontally as shelving. Use Floating Shelves on page 360.

Custom Modifications		Finish Techniques	
ID	RD	Distressing	Heirlooming
	•	•	

**Species Availability (Wood)**

Rustic Alder	Rustic Alder	Cherry	Rustic Hickory	Maple	Oak
•	•	•	•	•	•

**Species Availability (All Laminates)**

High Glass	Horiz. Grain on Maple	Vert. Grain on Maple	Vert. Grain on Cherry	Vert. Grain on Oak
box color	box color	box color	box color	box color

**BOX COLUMN FILLERS, 3" WIDE  
Base - Fluted, Beaded Column  
27" Deep**

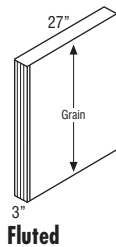

**Fluted**

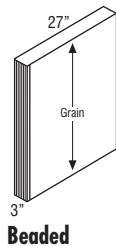

**Beaded**

**B334.527BCFF**

**B334.527BCFB**

- Available in 1" depth increments from 6" to 27".
- Reversible, may be used on either left or right end.
- Front and both sides finished.
- Enclosed top and bottom (not finished).
- 1/2" plywood construction.
- Finished veneer on end panel exterior.
- No reveal on filler.
- B334.527BCFF have Fluted fillers. B334.527BCFB have Beaded fillers.
- Not intended for use horizontally as shelving. Use Floating Shelves on page 360.

Custom Modifications		Finish Techniques	
ID	RD	Distressing	Heirlooming
	•	•	

**Species Availability (Wood)**

Rustic Alder	Rustic Alder	Cherry	Rustic Hickory	Maple	Oak
•	•	•	•	•	•

**Species Availability (All Laminates)**

High Glass	Horiz. Grain on Maple	Vert. Grain on Maple	Vert. Grain on Cherry	Vert. Grain on Oak
box color	box color	box color	box color	box color

**DESCRIPTION**

**BOX COLUMN FILLERS,  
1 1/2" WIDE  
Tall - Plain Column  
15" & 27" Deep**

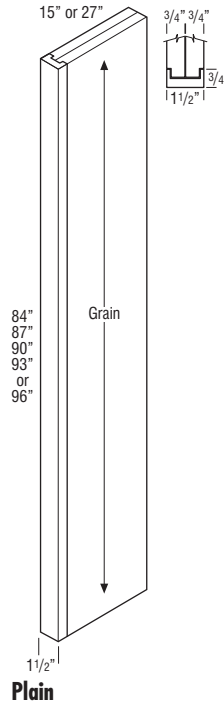

**Plain**

**MODEL**

- T1.58415BCFP** (15" Deep)
- T1.58715BCFP** (15" Deep)
- T1.59015BCFP** (15" Deep)
- T1.59315BCFP** (15" Deep)
- T1.59615BCFP** (15" Deep)
- T1.58427BCFP** (27" Deep)
- T1.58727BCFP** (27" Deep)
- T1.59027BCFP** (27" Deep)
- T1.59327BCFP** (27" Deep)
- T1.59627BCFP** (27" Deep)

- Available in 1" depth increments from 6" to 27".
- Reversible, may be used on either left or right end.
- Front and both sides finished. Top, bottom, and back are unfinished.
- Plywood construction.
- Finished veneer on end panel exterior.

Custom Modifications		Finish Techniques	
ID	RD	Distressing	Heirlooming
•*	•	•	

\*ID only available on 15" deep.

**Species Availability (Wood)**

Rustic Alder	Rustic Alder	Cherry	Rustic Hickory	Maple	Oak
•	•	•	•	•	•

**Species Availability (All Laminates)**

High Glass	Horiz. Grain on Maple	Vert. Grain on Maple	Vert. Grain on Cherry	Vert. Grain on Oak
box color	box color	box color	box color	box color

**BOX COLUMN FILLERS, 3" WIDE  
Tall - Plain Column  
15" & 27" Deep**

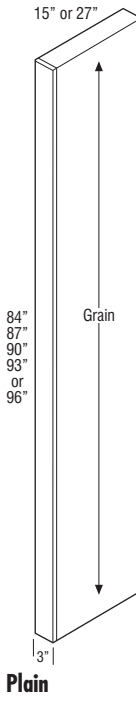

**Plain**

- T38415BCFP** (15" Deep)
- T38715BCFP** (15" Deep)
- T39015BCFP** (15" Deep)
- T39315BCFP** (15" Deep)
- T39615BCFP** (15" Deep)
- T38427BCFP** (27" Deep)
- T38727BCFP** (27" Deep)
- T39027BCFP** (27" Deep)
- T39327BCFP** (27" Deep)
- T39627BCFP** (27" Deep)

- Available in 1" depth increments from 6" to 27".
- Reversible, may be used on either left or right end.
- Front and both sides finished.
- Enclosed top and bottom (not finished).
- 1/2" plywood construction.
- Finished veneer on end panel exterior.
- No reveal on filler.
- Not intended for use horizontally as shelving. Use Floating Shelves on page 360.

Custom Modifications		Finish Techniques	
ID	RD	Distressing	Heirlooming
•*	•	•	

\*ID only available on 15" deep.

**Species Availability (Wood)**

Rustic Alder	Rustic Alder	Cherry	Rustic Hickory	Maple	Oak
•	•	•	•	•	•

**Species Availability (All Laminates)**

High Glass	Horiz. Grain on Maple	Vert. Grain on Maple	Vert. Grain on Cherry	Vert. Grain on Oak
box color	box color	box color	box color	box color

**DESCRIPTION**

**MODEL**

**BOX COLUMN FILLERS, 3" WIDE  
Tall - Fluted, Beaded Column  
15" & 27" Deep**

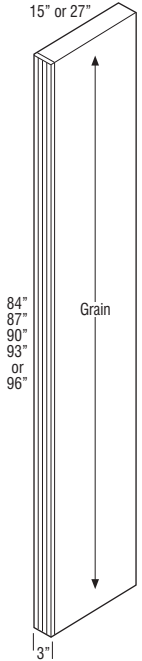

**Fluted**

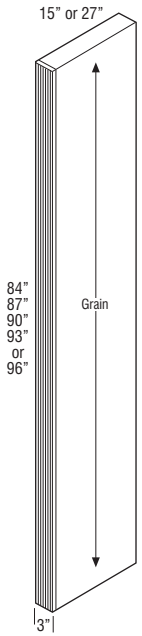

**Beaded**

- T38415BCFF (15" Deep)
- T38715BCFF (15" Deep)
- T39015BCFF (15" Deep)
- T39315BCFF (15" Deep)
- T39615BCFF (15" Deep)
- T38427BCFF (27" Deep)
- T38727BCFF (27" Deep)
- T39027BCFF (27" Deep)
- T39327BCFF (27" Deep)
- T39627BCFF (27" Deep)

- T38415BCFB (15" Deep)
- T38715BCFB (15" Deep)
- T39015BCFB (15" Deep)
- T39315BCFB (15" Deep)
- T39615BCFB (15" Deep)
- T38427BCFB (27" Deep)
- T38727BCFB (27" Deep)
- T39027BCFB (27" Deep)
- T39327BCFB (27" Deep)
- T39627BCFB (27" Deep)

- Available in 1" depth increments from 6" to 27".
- Reversible, may be used on either left or right end.
- Front and both sides finished.
- Enclosed top and bottom (not finished).
- 1/2" plywood construction.
- Finished veneer on end panel exterior.
- No reveal on filler.
- T3\_ \_BCFF have Fluted fillers. T3\_ \_BCFB have Beaded fillers.
- Not intended for use horizontally as shelving. Use Floating Shelves on page 360.

**Custom Modifications**

ID	RD
•*	•

\*ID only available on 15" deep.

**Finish Techniques**

Distressing	Heirlooming
	•

**Species Availability (Wood)**

	Rustic Alder	Cherry	Rustic Hickory	Maple	Oak
•	Alder	•	Hickory	•	•

**Species Availability (All Laminates)**

High Gloss	Horiz. Grain on Maple	Vert. Grain on Maple	Vert. Grain on Cherry	Vert. Grain on Oak
box color	box color	box color	box color	box color

**DESCRIPTION**

**MODEL**

**BOX COLUMN FILLERS, 6" WIDE  
Wall - Plain Column  
15" Deep**

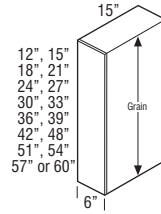

**Plain**

- W612BCFP
- W615BCFP
- W618BCFP
- W621BCFP
- W624BCFP
- W627BCFP
- W630BCFP
- W633BCFP
- W636BCFP
- W639BCFP
- W642BCFP
- W648BCFP
- W651BCFP
- W654BCFP
- W657BCFP
- W660BCFP

- Available in 1" depth increments from 6" to 27".
- Reversible, may be used on either left or right end.
- Front and both sides finished.
- Enclosed top and bottom (not finished).
- 1/2" plywood construction.
- Finished veneer on end panel exterior.
- No reveal on filler.
- Not intended for use horizontally as shelving. Use Floating Shelves on page 360.

**Custom Modifications**

ID	RD
•	•

**Finish Techniques**

Distressing	Heirlooming
•	

**Species Availability (Wood)**

	Rustic Alder	Cherry	Rustic Hickory	Maple	Oak
•	Alder	•	Hickory	•	•

**Species Availability (All Laminates)**

High Gloss	Horiz. Grain on Maple	Vert. Grain on Maple	Vert. Grain on Cherry	Vert. Grain on Oak
box color	box color	box color	box color	box color

**DESCRIPTION**

**MODEL**

**BOX COLUMN FILLERS, 6" WIDE**  
**Wall - Fluted, Beaded Column**  
**15" Deep**

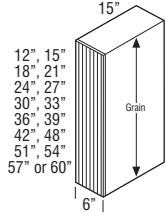

**Fluted**

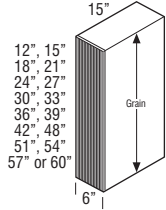

**Beaded**

- W612BCFF
- W615BCFF
- W618BCFF
- W621BCFF
- W624BCFF
- W627BCFF
- W630BCFF
- W633BCFF
- W636BCFF
- W639BCFF
- W642BCFF
- W648BCFF
- W651BCFF
- W654BCFF
- W657BCFF
- W660BCFF

- W612BCFB
- W615BCFB
- W618BCFB
- W621BCFB
- W624BCFB
- W627BCFB
- W630BCFB
- W633BCFB
- W636BCFB
- W639BCFB
- W642BCFB
- W648BCFB
- W651BCFB
- W654BCFB
- W657BCFB
- W660BCFB

- Available in 1" depth increments from 6" to 27".
- Reversible, may be used on either left or right end.
- Front and both sides finished.
- Enclosed top and bottom (not finished).
- 1/2" plywood construction.
- Finished veneer on end panel exterior.
- No reveal on filler.
- W6\_\_BCFF have Fluted fillers. W6\_\_BCFB have Beaded fillers.
- Not intended for use horizontally as shelving. Use Floating Shelves on page 360.

**Custom Modifications**

ID	RD
•	•

**Finish Techniques**

Distressing	Heirlooming
•	•

**Species Availability (Wood)**

Rustic Alder	Rustic Alder	Cherry	Rustic Hickory	Maple	Oak
•	•	•	•	•	•

**Species Availability (All Laminates)**

High Gloss	Horiz. Grain on Maple	Vert. Grain on Maple	Vert. Grain on Cherry	Vert. Grain on Oak
box color	box color	box color	box color	box color

**DESCRIPTION**

**MODEL**

**BOX COLUMN FILLERS, 6" WIDE**  
**Base - Plain Column**  
**27" Deep**

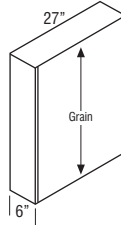

**Plain**

**B634.527BCFP**

- Available in 1" depth increments from 6" to 27".
- Reversible, may be used on either left or right end.
- Front and both sides finished.
- Enclosed top and bottom (not finished).
- 1/2" plywood construction.
- Finished veneer on end panel exterior.
- No reveal on filler.
- Not intended for use horizontally as shelving. Use Floating Shelves on page 360.

**Custom Modifications**

ID	RD
•	•

**Finish Techniques**

Distressing	Heirlooming
•	•

**Species Availability (Wood)**

Rustic Alder	Rustic Alder	Cherry	Rustic Hickory	Maple	Oak
•	•	•	•	•	•

**Species Availability (All Laminates)**

High Gloss	Horiz. Grain on Maple	Vert. Grain on Maple	Vert. Grain on Cherry	Vert. Grain on Oak
box color	box color	box color	box color	box color

**BOX COLUMN FILLERS, 6" WIDE**  
**Base - Fluted, Beaded Column**  
**27" Deep**

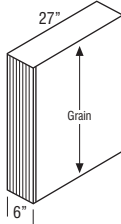

**Fluted**

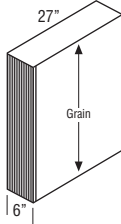

**Beaded**

**B634.527BCFF**

**B634.527BCFB**

- Available in 1" depth increments from 6" to 27".
- Reversible, may be used on either left or right end.
- Front and both sides finished.
- Enclosed top and bottom (not finished).
- 1/2" plywood construction.
- Finished veneer on end panel exterior.
- No reveal on filler.
- B634.527BCFF have Fluted fillers. B634.527BCFB have Beaded fillers.
- Not intended for use horizontally as shelving. Use Floating Shelves on page 360.

**Custom Modifications**

ID	RD
•	•

**Finish Techniques**

Distressing	Heirlooming
•	•

**Species Availability (Wood)**

Rustic Alder	Rustic Alder	Cherry	Rustic Hickory	Maple	Oak
•	•	•	•	•	•

**Species Availability (All Laminates)**

High Gloss	Horiz. Grain on Maple	Vert. Grain on Maple	Vert. Grain on Cherry	Vert. Grain on Oak
box color	box color	box color	box color	box color

**DESCRIPTION**

**BOX COLUMN FILLERS, 6" WIDE**  
**Tall - Plain Column**  
**15" & 27" Deep**

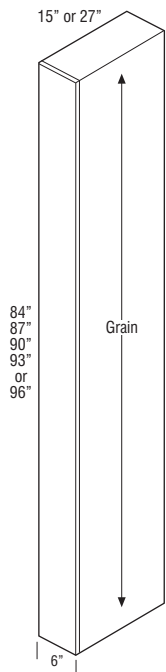

Plain

**MODEL**

- T68415BCFP (15" Deep)
- T68715BCFP (15" Deep)
- T69015BCFP (15" Deep)
- T69315BCFP (15" Deep)
- T69615BCFP (15" Deep)
- T68427BCFP (27" Deep)
- T68727BCFP (27" Deep)
- T69027BCFP (27" Deep)
- T69327BCFP (27" Deep)
- T69627BCFP (27" Deep)

- Available in 1" depth increments from 6" to 27".
- Reversible, may be used on either left or right end.
- Front and both sides finished.
- Enclosed top and bottom (not finished).
- 1/2" plywood construction.
- Finished veneer on end panel exterior.
- No reveal on filler.
- Not intended for use horizontally as shelving. Use Floating Shelves on page 360.

**Custom Modifications**

ID	RD
•*	•

**Finish Techniques**

Distressing	Heirlooming
•	

\*ID only available on 15" deep.

**Species Availability (Wood)**

	Rustic Alder	Cherry	Rustic Hickory	Maple	Oak
•	Alder	•	Hickory	•	•

**Species Availability (All Laminates)**

High Gloss	Horiz. Grain on Maple	Vert. Grain on Maple	Vert. Grain on Cherry	Vert. Grain on Oak
box color	box color	box color	box color	box color

**DESCRIPTION**

**BOX COLUMN FILLERS, 6" WIDE**  
**Tall - Fluted, Beaded Column**  
**15" & 27" Deep**

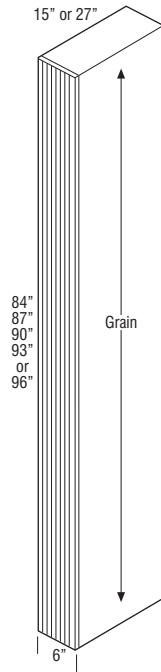

Fluted

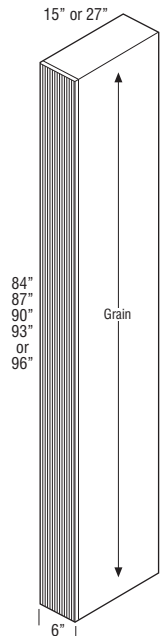

Beaded

**MODEL**

- T68415BCFF (15" Deep)
- T68715BCFF (15" Deep)
- T69015BCFF (15" Deep)
- T69315BCFF (15" Deep)
- T69615BCFF (15" Deep)
- T68427BCFF (27" Deep)
- T68727BCFF (27" Deep)
- T69027BCFF (27" Deep)
- T69327BCFF (27" Deep)
- T69627BCFF (27" Deep)

- T68415BCFB (15" Deep)
- T68715BCFB (15" Deep)
- T69015BCFB (15" Deep)
- T69315BCFB (15" Deep)
- T69615BCFB (15" Deep)
- T68427BCFB (27" Deep)
- T68727BCFB (27" Deep)
- T69027BCFB (27" Deep)
- T69327BCFB (27" Deep)
- T69627BCFB (27" Deep)

- Available in 1" depth increments from 6" to 27".
- Reversible, may be used on either left or right end.
- Front and both sides finished.
- Enclosed top and bottom (not finished).
- 1/2" plywood construction.
- Finished veneer on end panel exterior.
- No reveal on filler.
- T6\_\_BCFF have Fluted fillers. T6\_\_BCFB have Beaded fillers.
- Not intended for use horizontally as shelving. Use Floating Shelves on page 360.

**Custom Modifications**

ID	RD
•*	•

**Finish Techniques**

Distressing	Heirlooming
	•

\*ID only available on 15" deep.

**Species Availability (Wood)**

	Rustic Alder	Cherry	Rustic Hickory	Maple	Oak
•	Alder	•	Hickory	•	•

**Species Availability (All Laminates)**

High Gloss	Horiz. Grain on Maple	Vert. Grain on Maple	Vert. Grain on Cherry	Vert. Grain on Oak
box color	box color	box color	box color	box color

**DESCRIPTION**  
**PANELS & SKINS**

**MODEL**

**END PANEL SKINS, BASE**

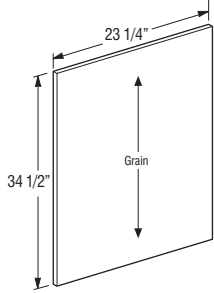

1/4" Finished  
**BEPS34.5WD**

- Stains: 1/4" thick veneered furniture board.
- Paints: 1/4" thick veneered or solid furniture board.
- 1/4" (WD) skins recommended for use with PFINBTMB modification.

**Custom Modifications**

ID	RD
•	•

**Finish Techniques**

Distressing	Heirlooming

**Species Availability (Wood)**

Rustic Alder	Rustic Alder	Cherry	Rustic Hickory	Maple	Oak
•		•		•	•

**Species Availability (All Laminates)**

High Glass	Horiz. Grain on Maple	Vert. Grain on Maple	Vert. Grain on Cherry	Vert. Grain on Oak
box color	box color	box color	box color	box color

**END PANEL SKINS, PREMIUM - BASE**

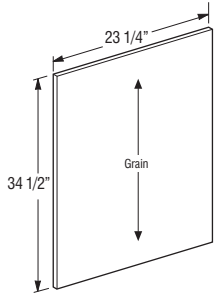

**BEPS34.5P**

- 1/4" thick laminated MDF.
- Not compatible with FPEB.
- High Glass panels do not have grain.
- 1/4" skins recommended for use with PFINBTMB modification.

**Custom Modifications**

ID	RD
•	•

**Finish Techniques**

Distressing	Heirlooming

**Species Availability (Wood)**

Rustic Alder	Rustic Alder	Cherry	Rustic Hickory	Maple	Oak

**Species Availability (All Laminates)**

High Glass	Horiz. Grain on Maple	Vert. Grain on Maple	Vert. Grain on Cherry	Vert. Grain on Oak
•		•	•	•

**DESCRIPTION**

**MODEL**

**END PANEL SKINS, TALL**



- 1/4" Finished  
**TEPS1248WD**  
**TEPS1284WD†**  
**TEPS1296WD†**  
**TEPS12102WD† ♦**  
**TEPS12108WD† ♦**  
**TEPS12120WD† ♦**

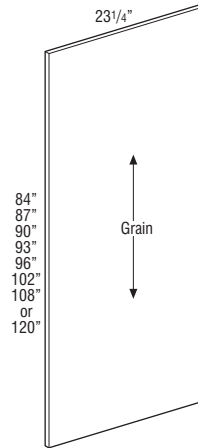
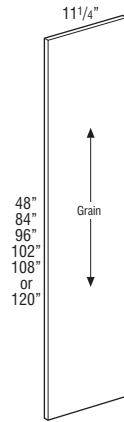

- 1/4" Finished  
**TEPS84WD†**  
**TEPS87WD†**  
**TEPS90WD†**  
**TEPS93WD†**  
**TEPS96WD†**  
**TEPS102WD† ♦**  
**TEPS108WD† ♦**  
**TEPS120WD† ♦**

- Stains: 1/4" thick veneered furniture board.
- Paints: 1/4" thick veneered or solid furniture board.
- 1/4" (WD) skins recommended for use with PFINBTMB modification.

†5 day Express Response not available on items greater than 48".

**Custom Modifications**

ID	RD
•	•

**Finish Techniques**

Distressing	Heirlooming

**Species Availability (Wood)**

Rustic Alder	Rustic Alder	Cherry	Rustic Hickory	Maple	Oak
•		•		•	•

♦ Only available in Cherry and Maple.

**Species Availability (All Laminates)**

High Glass	Horiz. Grain on Maple	Vert. Grain on Maple	Vert. Grain on Cherry	Vert. Grain on Oak
box color	box color	box color	box color	box color

♦ Only available in Cherry and Maple box colors.

**DESCRIPTION**

**MODEL**

**END PANEL SKINS, PREMIUM - TALL**



- TEPS1248P
- TEPS1296P†
- TEPS12102P†
- TEPS12108P†
- TEPS12120P†

- TEPS84P†
- TEPS87P†
- TEPS90P†
- TEPS93P†
- TEPS96P†
- TEPS102P†
- TEPS108P†
- TEPS120P†

- 1/4" thick laminated MDF.
- Not compatible with FPFB.
- High Gloss panels do not have grain.
- 1/4" skins recommended for use with PFINTMB modification.

†5 day Express Response not available on items greater than 48".

Custom Modifications		Finish Techniques	
ID	RD	Distressing	Heirlooming
•	•		

**Species Availability (Wood)**

Alder	Rustic Alder	Cherry	Rustic Hickory	Maple	Oak
•	•		•		

**Species Availability (All Laminates)**

High Gloss	Horiz. Grain on Maple	Vert. Grain on Maple	Vert. Grain on Cherry	Vert. Grain on Oak
•		•*	•*	•*

\*TEPS12102P, TEPS12108P, TEPS12120P, TEPS102P, TEPS108P, and TEPS120P not available in Laminate AJ and Laminate AK.

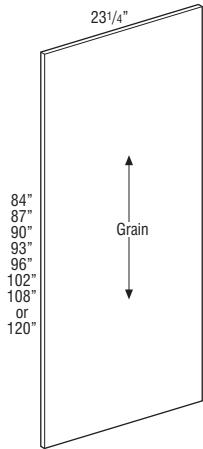
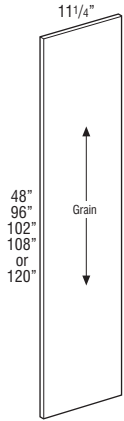

**END PANEL SKINS, WALL**



- 1/4" Finished
- WEPS30WD
- WEPS33WD
- WEPS36WD
- WEPS39WD
- WEPS42WD

- Stains: 1/4" thick veneered furniture board.
- Paints: 1/4" thick veneered or solid furniture board.
- Not compatible with Furniture Ends (FPFB).
- 1/4" (WD) skins recommended for use with PFINTMB modification.

Custom Modifications		Finish Techniques	
ID	RD	Distressing	Heirlooming
•	•		

**Species Availability (Wood)**

Alder	Rustic Alder	Cherry	Rustic Hickory	Maple	Oak
•	•		•		

**Species Availability (All Laminates)**

High Gloss	Horiz. Grain on Maple	Vert. Grain on Maple	Vert. Grain on Cherry	Vert. Grain on Oak
•	•	•	•	•

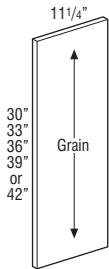

**DESCRIPTION**

**MODEL**

**END PANEL SKINS, PREMIUM - WALL**



- WEPS30P
- WEPS33P
- WEPS36P
- WEPS39P
- WEPS42P

- 1/4" thick laminated MDF.
- Not compatible with FPFB.
- High Gloss panels do not have grain.
- 1/4" skins recommended for use with PFINTMB modification.

Custom Modifications		Finish Techniques	
ID	RD	Distressing	Heirlooming
•	•		

**Species Availability (Wood)**

Alder	Rustic Alder	Cherry	Rustic Hickory	Maple	Oak
•	•		•		

**Species Availability (All Laminates)**

High Gloss	Horiz. Grain on Maple	Vert. Grain on Maple	Vert. Grain on Cherry	Vert. Grain on Oak
•		•	•	•

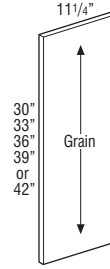

**FINISHED BACK SKINS**



- 1/4" Finished
- BP4830WD
- BP4834.5WD
- BP4840.5WD

- 1/4" Finished
- BP4896WD†

- Stains: 1/4" thick veneered furniture board.
- Paints: 1/4" thick veneered or solid furniture board.
- For custom sizes refer to DAPNL 1/4.

†5 day Express Response not available on items greater than 48".

Custom Modifications		Finish Techniques	
ID	RD	Distressing	Heirlooming
•	•		

**Species Availability (Wood)**

Alder	Rustic Alder	Cherry	Rustic Hickory	Maple	Oak
•	•		•		

**Species Availability (All Laminates)**

High Gloss	Horiz. Grain on Maple	Vert. Grain on Maple	Vert. Grain on Cherry	Vert. Grain on Oak
•	•	•	•	•

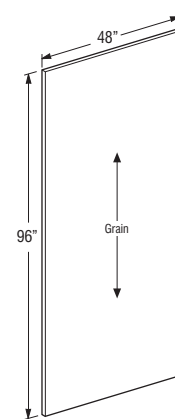
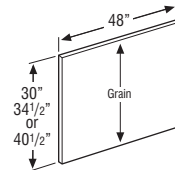

**BACK SKIN, INTERIOR**

- 1/4" Natural Maple Laminate
- BP4896LAM

- BP4896LAM is 1/4" thick furniture board with Natural Maple laminate to match standard cabinet interior.

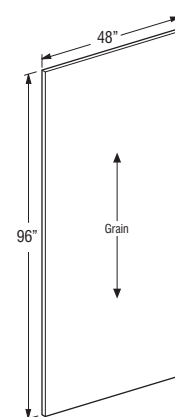



**DESCRIPTION**

**FINISHED BACK SKINS, PREMIUM**

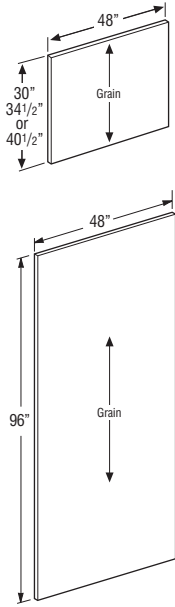

**MODEL**

**BP4830P**  
**BP4834.5P**  
**BP4840.5P**

**BP4896P†**

- 1/4" thick laminated MDF.
  - High Gloss panels do not have grain.
  - Not compatible with FPEB.
- †5 day Express Response not available on items greater than 48".

**Custom Modifications**

ID	RD

**Finish Techniques**

Distressing	Heirlooming

**Species Availability (Wood)**

Rustic Alder	Rustic Alder	Cherry	Rustic Hickory	Maple	Oak

**Species Availability (All Laminates)**

High Gloss	Horiz. Grain on Maple	Vert. Grain on Maple	Vert. Grain on Cherry	Vert. Grain on Oak
•		•	•	•

**CROSS GRAIN VENEER BACK SKIN 1/4" PANELS**

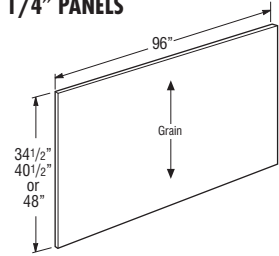

**BP9634.5CRSGR**  
**BP9640.5CRSGR**  
**BP9648CRSGR**

- BP96\_\_\_\_CRSGR is a 1/4" thick veneered panel with an MDF core.
- When ordered in Paint finishes, panels will use vertical grain as grain will not be visible.

**Custom Modifications**

ID	RD

**Finish Techniques**

Distressing	Heirlooming

**Species Availability (Wood)**

Rustic Alder	Rustic Alder	Cherry	Rustic Hickory	Maple	Oak
•	•	•	•	•	•

**Species Availability (All Laminates)**

High Gloss	Horiz. Grain on Maple	Vert. Grain on Maple	Vert. Grain on Cherry	Vert. Grain on Oak
box color	box color	box color	box color	box color

**DESCRIPTION**

**WOOD V-GROOVED BEADED SKIN 1/4" PANELS**

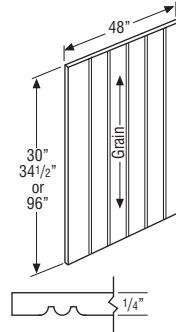

**MODEL**

**BP4830VG**  
**BP4834.5VG**  
**BP4896VG†**

- BP48\_\_VG is a 1/4" thick veneered panel with an MDF core.
  - V-groove on 3" centers.
  - When used as a skin, not compatible in conjunction with Furniture Ends (FPEB) or Authentic Ends (AUTHL/AUTHR/AUTHB).
- †5 day Express Response not available on items greater than 48".

**Custom Modifications**

ID	RD

**Finish Techniques**

Distressing	Heirlooming
	•

**Species Availability (Wood)**

Rustic Alder	Rustic Alder	Cherry	Rustic Hickory	Maple	Oak
•	•	•	•	•	•

**Species Availability (All Laminates)**

High Gloss	Horiz. Grain on Maple	Vert. Grain on Maple	Vert. Grain on Cherry	Vert. Grain on Oak
box color	box color	box color	box color	box color

**HORIZONTAL GRAIN 1/4" SKIN, PREMIUM**

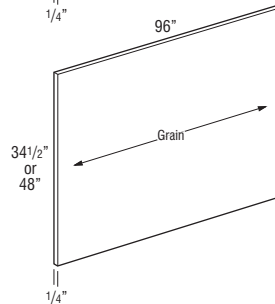
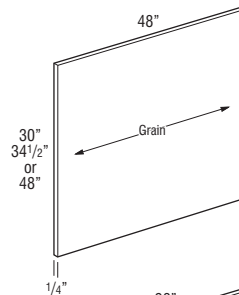
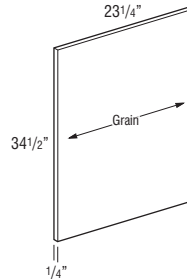
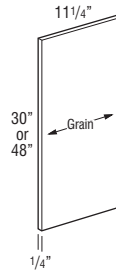

**14PANEL11.2530P**  
**14PANEL11.2548P**

**14PANEL2334.5P**

**14PANEL4830P**  
**14PANEL4834.5P**  
**14PANEL4848P†**

**14PANEL9634.5P†**  
**14PANEL9648P†**

- 1/4" thick laminated MDF.
  - Not compatible with FPEB.
- †5 day Express Response not available on items 48" and greater.

**Custom Modifications**

ID	RD

**Finish Techniques**

Distressing	Heirlooming

**Species Availability (Wood)**

Rustic Alder	Rustic Alder	Cherry	Rustic Hickory	Maple	Oak

**Species Availability (All Laminates)**

High Gloss	Horiz. Grain on Maple	Vert. Grain on Maple	Vert. Grain on Cherry	Vert. Grain on Oak
	•			

DESCRIPTION

MODEL

**HORIZONTAL GRAIN**  
**3/4" PANEL, PREMIUM**



**34PANEL1230P**  
**34PANEL1248P**

**34PANEL2434.5P**

**34PANEL4812P**

**34PANEL4834.5P**

**34PANEL4848P**

**34PANEL9612P†**

**34PANEL9624P†**

**34PANEL9630P†**

- 3/4" thick laminated MDF.
  - 34PANEL4812P and 34PANEL9612P recommended for exterior shelf material.
  - Edgebanded on one short side and one long side only. Other edges will require moulding if exposed.
- †5 day Express Response not available on items greater than 48".

Custom Modifications				Finish Techniques	
ID	RD	APC	MIP	Distressing	Heirlooming
•	•				

Species Availability (Wood)					
Alder	Rustic Alder	Cherry	Rustic Hickory	Maple	Oak
•	•	•	•	•	•

Species Availability (All Laminates)					
High Gloss	Horiz. Grain on Maple	Vert. Grain on Maple	Vert. Grain on Cherry	Vert. Grain on Oak	
•					

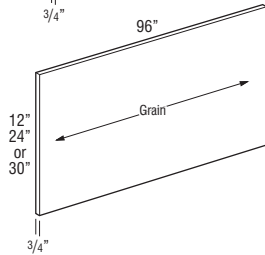
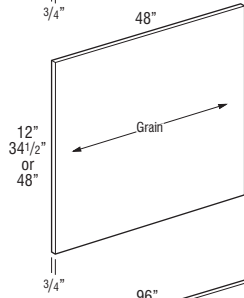
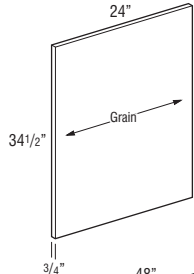
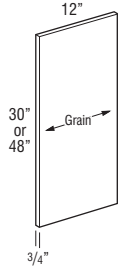

**END PANELS, WALL**



**3/4" Finished**

**WEP1230WD**

**3/4" White Laminate**

**WEP1230LAM ♦**

- WEP1230WD in Stains: 3/4" thick veneered furniture board.
- WEP1230WD in Paints: 3/4" thick veneered or solid furniture board.
- WEP1230LAM is 3/4" thick laminated furniture board (white only).
- Panels are finished on two sides and front edge.

Custom Modifications				Finish Techniques	
ID	RD	APC	MIP	Distressing	Heirlooming
•	•				
•	•				

Species Availability (Wood)					
Alder	Rustic Alder	Cherry	Rustic Hickory	Maple	Oak
•	•	•	•	•	•

♦ Only available in White laminate.

Species Availability (All Laminates)					
High Gloss	Horiz. Grain on Maple	Vert. Grain on Maple	Vert. Grain on Cherry	Vert. Grain on Oak	
•					
•	box color	box color	box color	box color	box color

♦ Only available in White laminate.

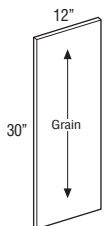

DESCRIPTION

MODEL

**END PANELS, PREMIUM - WALL**



**WEP1230P**

- 3/4" thick laminated MDF.
- High Gloss panels will have high gloss on front of panel and back of panel will be white laminate.
- High Gloss panels do not have grain.
- Front of panel and edgebanding on front, top, and bottom of panel will match doors.

Custom Modifications				Finish Techniques	
ID	RD	APC	MIP	Distressing	Heirlooming
•	•				

Species Availability (Wood)					
Alder	Rustic Alder	Cherry	Rustic Hickory	Maple	Oak
•	•	•	•	•	•

Species Availability (All Laminates)					
High Gloss	Horiz. Grain on Maple	Vert. Grain on Maple	Vert. Grain on Cherry	Vert. Grain on Oak	
•					

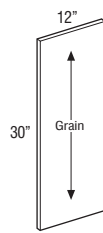

**END PANELS, BASE**



**3/4" Finished**

**BEPWD**

**3/4" White Laminate**

**BEPLAM ♦**

- BEPWD in Stains: 3/4" thick veneered furniture board.
- BEPWD in Paints: 3/4" thick veneered or solid furniture board.
- BEPLAM is 3/4" thick laminated furniture board (white only).
- Panels are finished on two sides and front edge.

Custom Modifications				Finish Techniques	
ID	RD	APC	MIP	Distressing	Heirlooming
•	•				
•	•				

Species Availability (Wood)					
Alder	Rustic Alder	Cherry	Rustic Hickory	Maple	Oak
•	•	•	•	•	•

♦ Only available in White laminate.

Species Availability (All Laminates)					
High Gloss	Horiz. Grain on Maple	Vert. Grain on Maple	Vert. Grain on Cherry	Vert. Grain on Oak	
•					
•	box color	box color	box color	box color	box color

♦ Only available in White laminate.

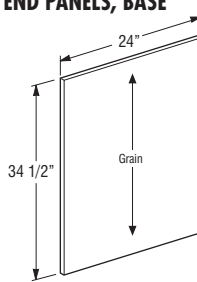

**END PANELS, PREMIUM - BASE**



**BEPB**

- 3/4" thick laminated MDF.
- High Gloss panels will have high gloss on front of panel and back of panel will be white laminate. Edgebanding on front edge will match door and drawer front edgebanding selection.
- High Gloss panels do not have grain.

Custom Modifications				Finish Techniques	
ID	RD	APC	MIP	Distressing	Heirlooming
•	•				

Species Availability (Wood)					
Alder	Rustic Alder	Cherry	Rustic Hickory	Maple	Oak
•	•	•	•	•	•

Species Availability (All Laminates)					
High Gloss	Horiz. Grain on Maple	Vert. Grain on Maple	Vert. Grain on Cherry	Vert. Grain on Oak	
•					

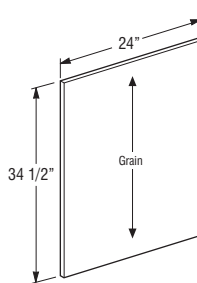

**DESCRIPTION**

**MODEL**

**END PANELS, LAZY SUSAN**

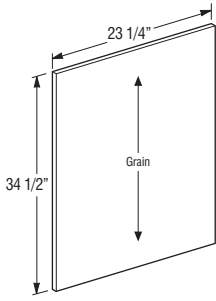

1/2" Finished

**BLSBEPWD**

1/2" Laminate

**BLSBEPLAM**

- BLSBEPWD: 1/2" thick veneered furniture board.
- BLSBEPLAM: 1/2" thick furniture board with matching laminate exterior. Not available in Paint AE, Paint Q, and Cherry Stain Z.
- All panels have Natural Maple laminate interior.

**Custom Modifications**

	ID	RD	APC	MIP
Laminate	•	•		
Wood	•	•	•	

**Finish Techniques**

Distressing	Heirlooming

**Species Availability (Wood)**

	Rustic Alder	Cherry	Rustic Hickory	Maple	Oak
• Alder	•	•	•	•	•

**Species Availability (All Laminates)**

High Gloss	Horiz. Grain on Maple	Vert. Grain on Maple	Vert. Grain on Cherry	Vert. Grain on Oak
box color	box color	box color	box color	box color

**DESCRIPTION**

**MODEL**

**END PANELS, TALL**

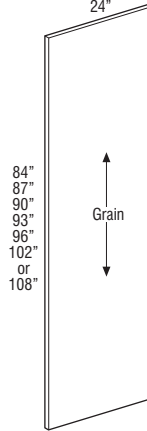
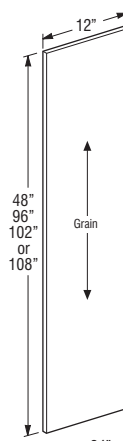

3/4" Finished

**TEP1248WD**

**TEP1296WD†**

**TEP12102WD† ♦♦**

**TEP12108WD† ♦♦**

3/4" White Laminate

**TEP1248LAM ♦**

**TEP1296LAM† ♦**

3/4" Finished

**TEP2484WD†▲**

**TEP2487WD†▲**

**TEP2490WD†▲**

**TEP2493WD†▲**

**TEP2496WD†▲**

**TEP24102WD† ♦♦**

**TEP24108WD† ♦♦**

3/4" White Laminate

**TEP2484LAM† ♦**

**TEP2487LAM† ♦**

**TEP2490LAM† ♦**

**TEP2493LAM† ♦**

**TEP2496LAM† ♦**

- TEP\_\_WD in Stains: 3/4" thick veneered furniture board.
  - TEP\_\_WD in Paints: 3/4" thick veneered or solid furniture board.
  - TEP\_\_LAM is 3/4" thick laminated furniture board (white only).
  - Panels are finished on two sides and front edge.
  - 102" and 108" will have APC and MIP standard.
- †5 day Express Response not available on items greater than 48".

**Custom Modifications**

	ID	RD	APC	MIP
Laminate	•	•		
Wood	•▲	•	•	

**Finish Techniques**

Distressing	Heirlooming

▲Tall wood panels will be plywood when ID31-ID36 is specified.

**Species Availability (Wood)**

	Rustic Alder	Cherry	Rustic Hickory	Maple	Oak
• Alder	•	•	•	•	•

- ♦ Only available in White laminate.
- ♦♦ Only available in Cherry and Maple.

**Species Availability (All Laminates)**

High Gloss	Horiz. Grain on Maple	Vert. Grain on Maple	Vert. Grain on Cherry	Vert. Grain on Oak
box color	box color	box color	box color	box color

- ♦ Only available in White laminate.
- ♦♦ Only available in Cherry and Maple box colors.

**DESCRIPTION**

**MODEL**

**END PANELS, PREMIUM - TALL**



- TEP1248P
- TEP1296P†
- TEP12102P†
- TEP12108P†

- TEP2484P†
- TEP2487P†
- TEP2490P†
- TEP2493P†
- TEP2496P†
- TEP24102P†
- TEP24108P†

- 3/4" thick laminated MDF.
  - High Gloss panels will have high gloss on front of panel and back of panel will be white laminate. Edgingbanding on front edge will match door and drawer front edgingbanding selection.
  - High Gloss panels do not have grain.
- †5 day Express Response not available on items greater than 48".

**Custom Modifications**

ID	RD
•*	•

**Finish Techniques**

Distressing	Heirlooming

\*ID available on TEP2484P-TEP2496P up to 30". ID not available on TEP24102P and TEP24108P.

**Species Availability (Wood)**

Alder	Rustic Alder	Cherry	Rustic Hickory	Maple	Oak

**Species Availability (All Laminates)**

High Gloss	Horiz. Grain on Maple	Vert. Grain on Maple	Vert. Grain on Cherry	Vert. Grain on Oak
•		•*	•*	•*

\*TEP12102P, TEP12108P, TEP24102P, and TEP24108P not available in Laminate AJ.

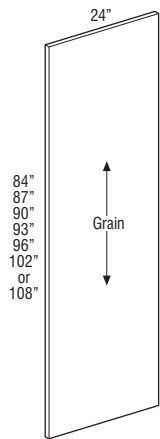
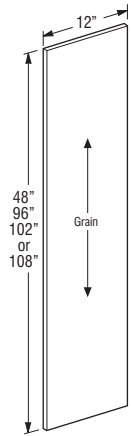

**END PANELS, VANITY**

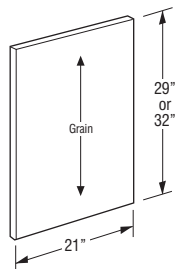

- 3/4" Finished
- VBEP2129WD
- VBEP2132WD
- 3/4" White Laminate
- VBEP2129LAM ♦
- VBEP2132LAM ♦

- VBEP\_ \_WD in Stains: 3/4" thick veneered furniture board.
- VBEP\_ \_WD in Paints: 3/4" thick veneered or solid furniture board.
- VBEP\_ \_LAM is 3/4" thick laminated furniture board (white only).
- Panels are finished on two sides and front edge.

**Custom Modifications**

ID	RD	APC	MIP
•	•		
•	•	•	

**Finish Techniques**

Distressing	Heirlooming

**Species Availability (Wood)**

Alder	Rustic Alder	Cherry	Rustic Hickory	Maple	Oak
•		•	Hickory		•

♦ Only available in White laminate.

**Species Availability (All Laminates)**

High Gloss	Horiz. Grain on Maple	Vert. Grain on Maple	Vert. Grain on Cherry	Vert. Grain on Oak
box color	box color	box color	box color	box color

♦ Only available in White laminate.

**DESCRIPTION**

**MODEL**

**WALL PANEL with FILLER ATTACHED**



- 1/2" Finished
- WEP1230F1.5WD
- WEP1230F3WD
- WEP1233F1.5WD
- WEP1233F3WD
- WEP1236F1.5WD
- WEP1236F3WD
- WEP1239F1.5WD
- WEP1239F3WD
- WEP1242F1.5WD
- WEP1242F3WD
- 1/2" White Laminate
- WEP1230F1.5LAM ♦
- WEP1230F3LAM ♦
- WEP1233F1.5LAM ♦
- WEP1233F3LAM ♦
- WEP1236F1.5LAM ♦
- WEP1236F3LAM ♦
- WEP1239F1.5LAM ♦
- WEP1239F3LAM ♦
- WEP1242F1.5LAM ♦
- WEP1242F3LAM ♦

- WEP\_ \_F\_ \_WD in Stains: 1/2" thick veneered furniture board.
- WEP\_ \_F\_ \_WD in Paints: 1/2" thick veneered or solid furniture board.
- WD panels have Natural Maple laminate interior. Specify MIP for matching veneered interior.
- WEP\_ \_F\_ \_LAM is 1/2" thick laminated furniture board (White exterior with Natural Maple interior).

**Custom Modifications**

	ID	RD	APC	MIP	WLI
Laminate	•	•			•
Wood	•	•	•	•	•

**Finish Techniques**

Distressing	Heirlooming
•*	

\*Distressing on filler only, not on panel. Not available on laminate panels.

**Species Availability (Wood)**

Alder	Rustic Alder	Cherry	Rustic Hickory	Maple	Oak
•		•	Hickory		•

♦ Only available in White laminate.

**Species Availability (All Laminates)**

High Gloss	Horiz. Grain on Maple	Vert. Grain on Maple	Vert. Grain on Cherry	Vert. Grain on Oak
box color	box color	box color	box color	box color

♦ Only available in White laminate.

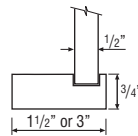
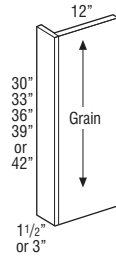

**DESCRIPTION**

**BASE and TALL PANELS with FILLER ATTACHED**

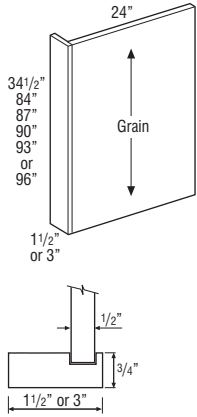

**MODEL**

1/2" Finished  
**BEPF1.5WD**  
**BEPF3WD**  
 1/2" White Laminate  
**BEPF1.5LAM** ♦  
**BEPF3LAM** ♦

1/2" Finished  
**TEP2484F1.5WD** †  
**TEP2484F3WD** †  
**TEP2487F1.5WD** †  
**TEP2487F3WD** †  
**TEP2490F1.5WD** †  
**TEP2490F3WD** †  
**TEP2493F1.5WD** †  
**TEP2493F3WD** †  
**TEP2496F1.5WD** †  
**TEP2496F3WD** †

1/2" White Laminate  
**TEP2484F1.5LAM** † ♦  
**TEP2484F3LAM** † ♦  
**TEP2487F1.5LAM** † ♦  
**TEP2487F3LAM** † ♦  
**TEP2490F1.5LAM** † ♦  
**TEP2490F3LAM** † ♦  
**TEP2493F1.5LAM** † ♦  
**TEP2493F3LAM** † ♦  
**TEP2496F1.5LAM** † ♦  
**TEP2496F3LAM** † ♦

- BEPF\_WD and TEP\_\_F\_WD in Stains: 1/2" thick veneered furniture board.
- BEPF\_WD and TEP\_\_F\_WD in Paints: 1/2" thick veneered or solid furniture board.
- WD panels have Natural Maple laminate interior. Specify MIP for matching veneered interior.
- BEPF\_LAM and TEP\_\_F\_LAM is 1/2" thick laminated furniture board (White exterior with Natural Maple interior).

†5 day Express Response not available on items greater than 48".

**Custom Modifications**

	ID	RD	APC	MIP	WLI
Laminate	•	•			•
Wood	•	•	•	•	•

**Finish Techniques**

Distressing	Heirlooming
•*	

\*Distressing on filler only, not on panel. Not available on laminate panels.

**Species Availability (Wood)**

Rustic Alder	Rustic Alder	Cherry	Rustic Hickory	Maple	Oak
•	• Alder	•	• Hickory	•	•

♦ Only available in White laminate.

**Species Availability (All Laminates)**

High Gloss	Horiz. Grain on Maple	Vert. Grain on Maple	Vert. Grain on Cherry	Vert. Grain on Oak
box color	box color	box color	box color	box color

♦ Only available in White laminate.

**DESCRIPTION**

**TALL PANELS with FILLER ATTACHED, 102" & 108" TALL**

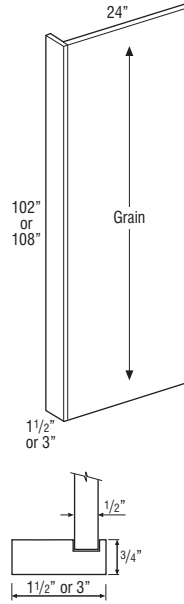

**MODEL**

1/2" Finished  
**TEP24102F1.5WD**  
**TEP24102F3WD**  
**TEP24108F1.5WD**  
**TEP24108F3WD**

- 1/2" thick veneered plywood.
- Panel will have veneered exterior and Natural Maple laminated interior.

**Custom Modifications**

APC	ID	RD
STD		•

**Finish Techniques**

Distressing	Heirlooming
•*	

\*Distressing on filler only, not on panel.

**Species Availability (Wood)**

Rustic Alder	Rustic Alder	Cherry	Rustic Hickory	Maple	Oak
				•	

**Species Availability (All Laminates)**

High Gloss	Horiz. Grain on Maple	Vert. Grain on Maple	Vert. Grain on Cherry	Vert. Grain on Oak
box color	box color	box color		

**WALL PANEL with FILLER ATTACHED and FURNITURE ENDS**

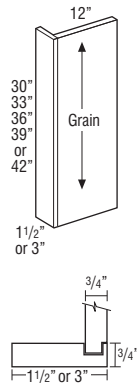

**WEP1230F1.5FPE**  
**WEP1230F3FPE**  
**WEP1233F1.5FPE**  
**WEP1233F3FPE**  
**WEP1236F1.5FPE**  
**WEP1236F3FPE**  
**WEP1239F1.5FPE**  
**WEP1239F3FPE**  
**WEP1242F1.5FPE**  
**WEP1242F3FPE**

- 3/4" thick veneered plywood.
- Panel will have veneered exterior and Natural Maple laminated interior.
- Specify MIP for matching veneered interior.

**Custom Modifications**

APC	ID	RD	MIP
STD	•	•	•

**Finish Techniques**

Distressing	Heirlooming
•	

**Species Availability (Wood)**

Rustic Alder	Rustic Alder	Cherry	Rustic Hickory	Maple	Oak
•	• Alder	•	• Hickory	•	•

**Species Availability (All Laminates)**

High Gloss	Horiz. Grain on Maple	Vert. Grain on Maple	Vert. Grain on Cherry	Vert. Grain on Oak
box color	box color	box color	box color	box color

DESCRIPTION

MODEL

BASE and TALL PANELS with FILLER ATTACHED and FURNITURE ENDS



BEPF1.5FPE  
BEPF3FPE

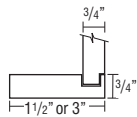
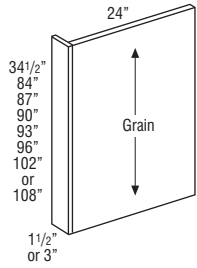

- TEP2484F1.5FPE†
- TEP2484F3FPE†
- TEP2487F1.5FPE†
- TEP2487F3FPE†
- TEP2490F1.5FPE†
- TEP2490F3FPE†
- TEP2493F1.5FPE†
- TEP2493F3FPE†
- TEP2496F1.5FPE†
- TEP2496F3FPE†
- TEP24102F1.5FPE† ♦
- TEP24102F3FPE† ♦
- TEP24108F1.5FPE† ♦
- TEP24108F3FPE† ♦

- 3/4" thick veneered plywood.
- Panel will have veneered exterior and Natural Maple laminated interior.

†5 day Express Response not available on items greater than 48".

Custom Modifications

APC	ID	RD	MIP
STD	•	•	•*

\*102" and 108" are MIP standard.

Finish Techniques

Distressing	Heirlooming
•	

Species Availability (Wood)

	Rustic Alder	Cherry	Rustic Hickory	Maple	Oak
•	Alder	•	Hickory	•	•

♦ Only available in Cherry and Maple.

Species Availability (All Laminates)

High Gloss	Horiz. Grain on Maple	Vert. Grain on Maple	Vert. Grain on Cherry	Vert. Grain on Oak
box color	box color	box color	box color	box color

♦ Only available in Cherry and Maple box colors.

DESCRIPTION

MODEL

WALL PANEL with FILLER ATTACHED and AUTHENTIC ENDS



- WEP1230F1.5AEL
- WEP1230F1.5AER
- WEP1230F3AEL
- WEP1230F3AER
- WEP1233F1.5AEL
- WEP1233F1.5AER
- WEP1233F3AEL
- WEP1233F3AER
- WEP1236F1.5AEL
- WEP1236F1.5AER
- WEP1236F3AEL
- WEP1236F3AER
- WEP1239F1.5AEL
- WEP1239F1.5AER
- WEP1239F3AEL
- WEP1239F3AER
- WEP1242F1.5AEL
- WEP1242F1.5AER
- WEP1242F3AEL
- WEP1242F3AER

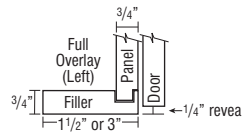
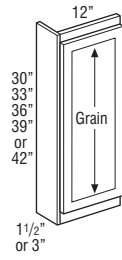

- 3/4" thick veneered plywood with doors attached.
- Depth can be increased in 3" increments up to 24" deep.
- Panel will have veneered exterior and Natural Maple laminated interior standard. Specify MIP for matching veneered interior.
- Door 25 doors will be high gloss and match edgebanding selection.
- Door 33 doors will have horizontal grain with matching edgebanding.
- Door 36 doors will have vertical grain with matching edgebanding.

Custom Modifications

APC	DPSRR	ID	RD	MFO	MIP
STD	•	•	•	•	•

Finish Techniques

Distressing	Heirlooming
•	•

Species Availability (Wood)

	Rustic Alder	Cherry	Rustic Hickory	Maple	Oak
•	Alder	•	Hickory	•	•

Species Availability (All Laminates)

High Gloss	Horiz. Grain on Maple	Vert. Grain on Maple	Vert. Grain on Cherry	Vert. Grain on Oak
box color	box color	box color	box color	box color

**DESCRIPTION**

**BASE PANEL with FILLER ATTACHED and AUTHENTIC ENDS**



**MODEL**

**BEPF1.5AEL**  
**BEPF1.5AER**  
**BEPF3AEL**  
**BEPF3AER**

- 3/4" thick veneered plywood with doors attached.
- Depth can be increased in 3" increments up to 36" deep.
- Panel will have veneered exterior and Natural Maple laminated interior standard. Specify MIP for matching veneered interior.
- Door 25 doors will be high gloss and match edgebanding selection.
- Door 33 doors will have horizontal grain with matching edgebanding.
- Door 36 doors will have vertical grain with matching edgebanding.

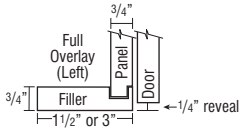
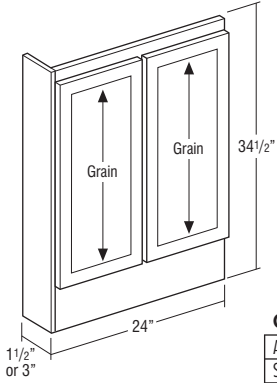

Custom Modifications					
APC	DPSRR	ID	RD	MFO	MIP
STD	•	•	•	•	•

Finish Techniques	
Distressing	Heirlooming
•	•

**Species Availability (Wood)**

Rustic Alder	Cherry	Rustic Hickory	Maple	Oak
• Alder	•	• Hickory	•	•

**Species Availability (All Laminates)**

High Gloss box color	Horiz. Grain on Maple box color	Vert. Grain on Maple box color	Vert. Grain on Cherry box color	Vert. Grain on Oak box color
•	•	•	•	•

**BASE PANEL with FILLER ATTACHED and AUTHENTIC ENDS, SINGLE DOOR**



**BEPF1.5AELSD**  
**BEPF1.5AERSD**  
**BEPF3AELSD**  
**BEPF3AERSD**

- 3/4" thick veneered plywood with doors attached.
- Depth can be reduced in 3" increments down to 9" deep.
- Panel will have veneered exterior and Natural Maple laminated interior standard. Specify MIP for matching veneered interior.
- Door 25 doors will be high gloss and match edgebanding selection.
- Door 33 doors will have horizontal grain with matching edgebanding.
- Door 36 doors will have vertical grain with matching edgebanding.

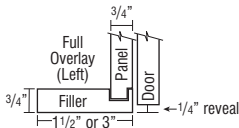
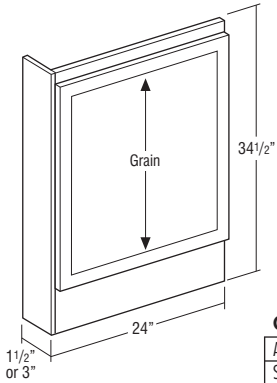

Custom Modifications					
APC	DPSRR	ID	RD	MFO	MIP
STD	•	•	•	•	•

Finish Techniques	
Distressing	Heirlooming
•	•

**Species Availability (Wood)**

Rustic Alder	Cherry	Rustic Hickory	Maple	Oak
• Alder	•	• Hickory	•	•

**Species Availability (All Laminates)**

High Gloss box color	Horiz. Grain on Maple box color	Vert. Grain on Maple box color	Vert. Grain on Cherry box color	Vert. Grain on Oak box color
•	•	•	•	•

**DESCRIPTION**

**TALL PANEL with FILLER ATTACHED and AUTHENTIC ENDS**

**MODEL**

**TEP2484F1.5AEL**  
**TEP2484F1.5AER**  
**TEP2484F3AEL**  
**TEP2484F3AER**  
**TEP2487F1.5AEL**  
**TEP2487F1.5AER**  
**TEP2487F3AEL**  
**TEP2487F3AER**  
**TEP2490F1.5AEL**  
**TEP2490F1.5AER**  
**TEP2490F3AEL**  
**TEP2490F3AER**  
**TEP2493F1.5AEL**  
**TEP2493F3AEL**  
**TEP2496F1.5AEL**  
**TEP2496F3AEL**  
**TEP2496F3AER**

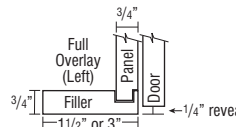
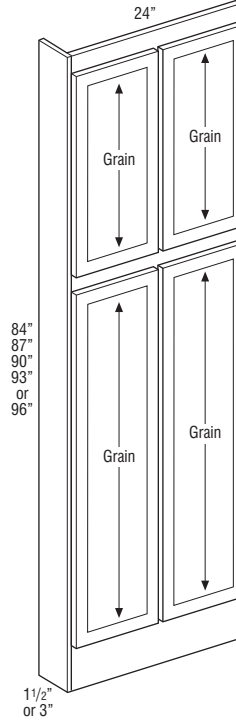

- 3/4" thick veneered plywood with doors attached.
- Depth can be increased in 3" increments up to 36" deep.
- Panel will have veneered exterior and Natural Maple laminated interior standard. Specify MIP for matching veneered interior.
- Door 25 doors will be high gloss and match edgebanding selection.
- Door 33 doors will have horizontal grain with matching edgebanding.
- Door 36 doors will have vertical grain with matching edgebanding.

Custom Modifications						
APC	DPSRR	ID	RD	MFO	MIP	INVFRM
STD	•	•	•	•	•	•

Finish Techniques	
Distressing	Heirlooming
•	•

**Species Availability (Wood)**

Rustic Alder	Cherry	Rustic Hickory	Maple	Oak
• Alder	•	• Hickory	•	•

**Species Availability (All Laminates)**

High Gloss box color	Horiz. Grain on Maple box color	Vert. Grain on Maple box color	Vert. Grain on Cherry box color	Vert. Grain on Oak box color
•	•	•	•	•

**DESCRIPTION**

**TALL PANEL with FILLER ATTACHED and AUTHENTIC ENDS, SINGLE DOOR**

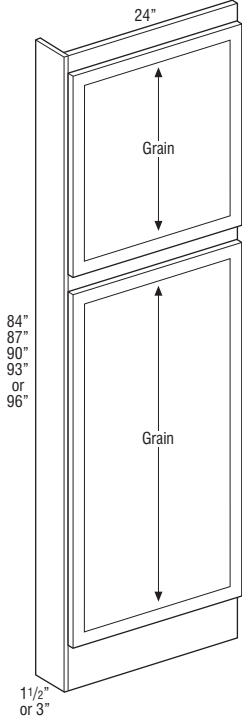

**MODEL**

- TEP84F1.5AELSD
- TEP84F1.5AERSD
- TEP84F3AELSD
- TEP84F3AERSD
- TEP87F1.5AELSD
- TEP87F1.5AERSD
- TEP87F3AELSD
- TEP87F3AERSD
- TEP90F1.5AELSD
- TEP90F1.5AERSD
- TEP90F3AELSD
- TEP90F3AERSD
- TEP93F1.5AELSD
- TEP93F1.5AERSD
- TEP93F3AELSD
- TEP93F3AERSD
- TEP96F1.5AELSD
- TEP96F1.5AERSD
- TEP96F3AELSD
- TEP96F3AERSD

- 3/4" thick veneered plywood with doors attached.
- Depth can be reduced in 3" increments down to 9" deep.
- On non-miter doors, the tall door on the bottom will have two vertical panels.
- Panel will have veneered exterior and Natural Maple laminated interior standard. Specify MIP for matching veneered interior.
- Door 25 doors will be high gloss and match edgebanding selection.
- Door 33 doors will have horizontal grain with matching edgebanding.
- Door 36 doors will have vertical grain with matching edgebanding.

Custom Modifications							Finish Techniques	
APC	DPSRR	ID	RD	MFO	MIP	INVFRM	Distressing	Heirlooming
STD	•	•	•	•	•	•	•	•

Species Availability (Wood)						
	Rustic Alder	Alder	Cherry	Rustic Hickory	Maple	Oak
•	•	•	•	•	•	•

Species Availability (All Laminates)					
High Gloss	Horiz. Grain on Maple	Vert. Grain on Maple	Vert. Grain on Cherry	Vert. Grain on Oak	
box color	box color	box color	box color	box color	box color

**VANITY DESK LEGS**

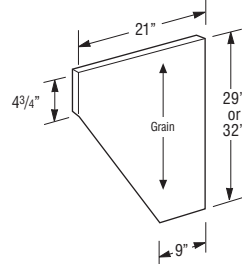

- VDL2129WD
- VDL2132WD

- All panels are finished 2 sides and front edge.
- VDL\_\_WD in Stains: 3/4" thick veneered furniture board.
- VDL\_\_WD in Paints: 3/4" thick veneered or solid furniture board.

Custom Modifications		Finish Techniques	
ID	RD	Distressing	Heirlooming

Species Availability (Wood)						
	Rustic Alder	Alder	Cherry	Rustic Hickory	Maple	Oak
•	•	•	•	•	•	•

Species Availability (All Laminates)					
High Gloss	Horiz. Grain on Maple	Vert. Grain on Maple	Vert. Grain on Cherry	Vert. Grain on Oak	
box color	box color	box color	box color	box color	box color

**DESCRIPTION**

**WOOD V-GROOVED with TRIPLE BEADED FRONT 3/4" PANELS**

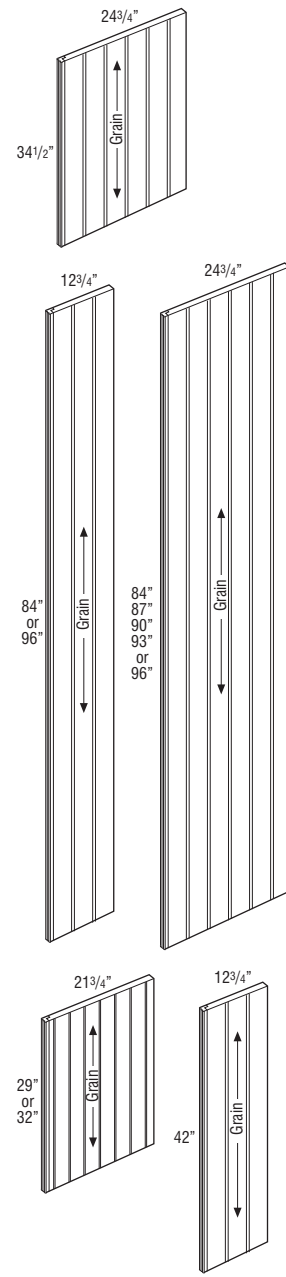

**MODEL**

- BEPVG (34 1/2") 24 3/4"
- TEP1284VG† 12 3/4"
- TEP1296VG† 12 3/4"
- TEP84VG† 24 3/4"
- TEP87VG† 24 3/4"
- TEP90VG† 24 3/4"
- TEP93VG† 24 3/4"
- TEP96VG† 24 3/4"
- VBEP29VG 21 3/4"
- VBEP32VG 21 3/4"
- WEP42VG 12 3/4"

- Veneer on MDF core.
- V-groove on 3" centers.
- †5 day Express Response not available on items greater than 48".

Custom Modifications		Finish Techniques	
ID	RD	Distressing	Heirlooming
			•

Species Availability (Wood)					
	Rustic Alder	Cherry	Rustic Hickory	Maple	Oak
•	•	•	•	•	•

Species Availability (All Laminates)					
High Gloss	Horiz. Grain on Maple	Vert. Grain on Maple	Vert. Grain on Cherry	Vert. Grain on Oak	
box color	box color	box color	box color	box color	box color



**DESCRIPTION**

**MODEL**

**DECORATIVE DOOR  
PANEL KITS  
Base End**



**BED**

**BEDSD**

- Door panel kits include Base End Panel Skin and doors with attachment screws for field installation.
- Not compatible on cabinets specified with FPEB. Use Authentic Ends modification for decorative doors with FPEB.
- Door 25 doors will be high gloss and match edgebanding selection.
- Door 33 doors will have horizontal grain with matching edgebanding.
- Door 36 doors will have vertical grain with matching edgebanding.

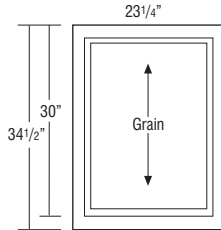
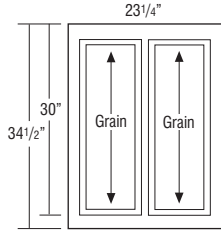

**Custom Modifications**

DPSRR	ID	RD	MFO
•			

**Finish Techniques**

Distressing	Heirlooming
•	•

**Species Availability (Wood)**

Rustic Alder	Cherry	Rustic Hickory	Maple	Oak
•	•	•	•	•

**Species Availability (All Laminates)**

High Gloss box color	Horiz. Grain on Maple box color	Vert. Grain on Maple box color	Vert. Grain on Cherry box color	Vert. Grain on Oak box color

**DESCRIPTION**

**MODEL**

**DECORATIVE DOOR  
PANEL KITS  
Tall End**

- TED2484
- TED2487
- TED2490
- TED2493
- TED2496

- TED2484SD
- TED2487SD
- TED2490SD
- TED2493SD
- TED2496SD

- Door panel kits include Tall End Panel Skin and doors with attachment screws for field installation.
- Not compatible on cabinets specified with FPEB. Use Authentic Ends modification for decorative doors with FPEB.
- On non-miter doors, the tall door on the bottom will have two vertical panels.
- Door 25 doors will be high gloss and match edgebanding selection.
- Door 33 doors will have horizontal grain with matching edgebanding.
- Door 36 doors will have vertical grain with matching edgebanding.

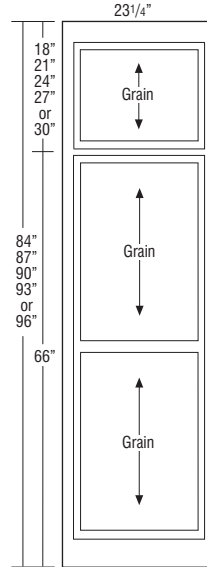
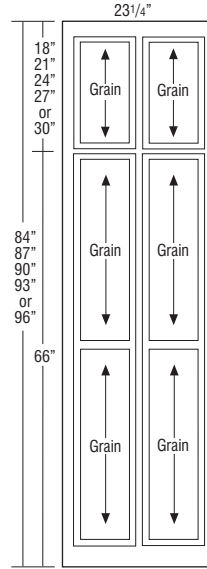

**Custom Modifications**

DPSRR	ID	RD	MFO
•			

**Finish Techniques**

Distressing	Heirlooming
•	•

**Species Availability (Wood)**

Rustic Alder	Cherry	Rustic Hickory	Maple	Oak
•	•	•	•	•

**Species Availability (All Laminates)**

High Gloss box color	Horiz. Grain on Maple box color	Vert. Grain on Maple box color	Vert. Grain on Cherry box color	Vert. Grain on Oak box color

**DESCRIPTION**

**MODEL**

**DECORATIVE DOOR  
PANEL KITS  
Wall End**

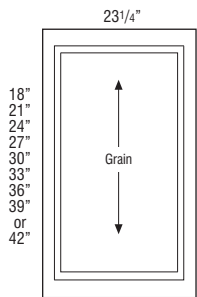
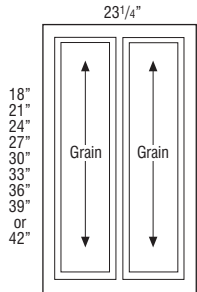
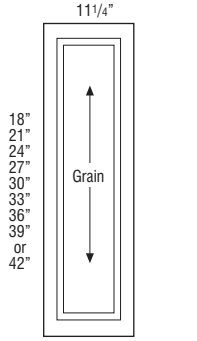

- WED1218
- WED1221
- WED1224
- WED1227
- WED1230
- WED1233
- WED1236
- WED1239
- WED1242

- WED2418
- WED2421
- WED2424
- WED2427
- WED2430
- WED2433
- WED2436
- WED2439
- WED2442

- WED2418SD
- WED2421SD
- WED2424SD
- WED2427SD
- WED2430SD
- WED2433SD
- WED2436SD
- WED2439SD
- WED2442SD

- Door panel kits include Wall End Panel Skin and doors with attachment screws for field installation.
- Custom door sizes not available.
- Not compatible on cabinets specified with FPEB. Use Authentic Ends modification for decorative doors with FPEB.
- Door 25 doors will be high gloss and match edgebanding selection.
- Door 33 doors will have horizontal grain with matching edgebanding.
- Door 36 doors will have vertical grain with matching edgebanding.

Custom Modifications				Finish Techniques	
DPSRR	ID	RD	MFO	Distressing	Heirlooming
•			•	•	•

**Species Availability (Wood)**

	Rustic Alder	Cherry	Rustic Hickory	Maple	Oak
• Alder	•	•	•	•	•

**Species Availability (All Laminates)**

	Horiz. Grain on Maple	Vert. Grain on Maple	Vert. Grain on Cherry	Vert. Grain on Oak
High Gloss	•	•	•	•
box color	•	•	•	•

**WAINSCOTING, 34 1/2" or 40 1/2" HIGH**

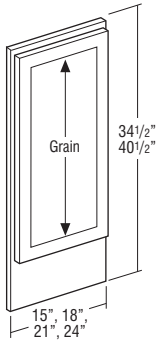

**WAIN1534.5-WAIN2440.5**

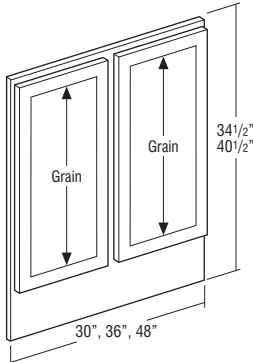

**WAIN3034.5-WAIN4840.5**

- WAIN1534.5**
- WAIN1834.5**
- WAIN2134.5**
- WAIN2434.5**
- WAIN1540.5**
- WAIN1840.5**
- WAIN2140.5**
- WAIN2440.5**

- WAIN3034.5**
- WAIN3634.5**
- WAIN4834.5**
- WAIN3040.5**
- WAIN3640.5**
- WAIN4840.5**

- WAIN6034.5**
- WAIN6040.5**

- WAIN7234.5**
- WAIN7240.5**

- Full Overlay Styles only.
- Panel is 1 1/2" thick including doors. Non-operating doors are applied to 3/4" thick rail and stile frame.
- Flush Toekick standard.
- Wainscoting panel backs are not finished, but are sealed to prevent warping and cracking.
- All faces and edges will be finished.
- For use on bars or islands, attach panel by securing the panel face frame through the inside of the applicable cabinet.
- For wall applications, the screw heads used for the panel face frame attachment to the wall can be concealed behind the doors and drawer fronts.

Product Code	Overall Width	Number of Doors	Number of Frame Center Stiles	Door Width
WAIN15..	15"	1	0	14 1/2"
WAIN18..	18"	1	0	17 1/2"
WAIN21..	21"	1	0	20 1/2"
WAIN24..	24"	1	0	23 1/2"
WAIN30..	30"	2	1	14 1/2"
WAIN36..	36"	2	1	17 1/2"
WAIN48..	48"	2	1	23 1/2"
WAIN60..	60"	4	3	14 1/2"
WAIN72..	72"	3	2	23 1/2"

Door height on 34 1/2" high panels is 29 1/2".  
 Door height on 40 1/2" high panels is 35 1/2".

**Custom Modifications**

EX	FTK	VTK
•	STD	•

**Door Options**

DPSRR
•

**Finish Techniques**

Distressing	Heirlooming
•	•

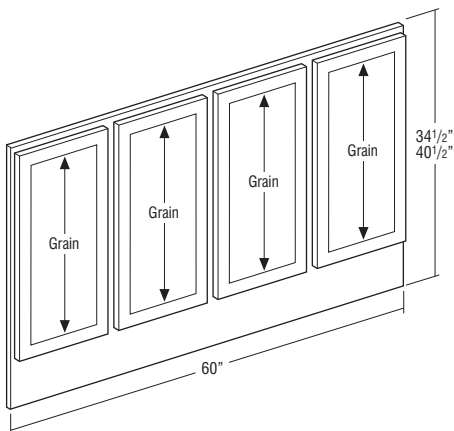

**WAIN6034.5-WAIN6040.5**

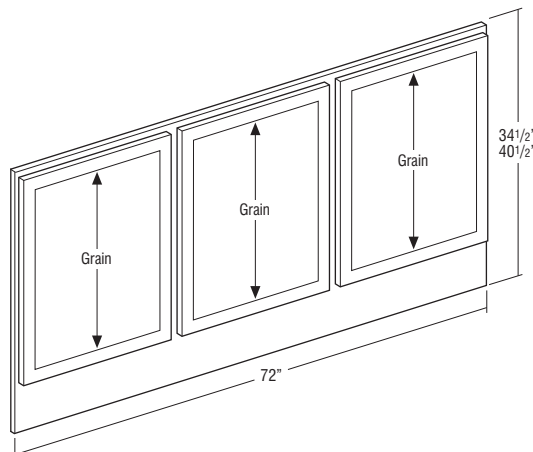

**WAIN7234.5-WAIN7240.5**

**DESCRIPTION MODEL**  
**CUSTOM PANELS, DOORS, & DRAWER FRONTS**

All custom panels and doors can be ordered through 20/20. For manual orders, please fax the order form to customer service. See page 329.

Due to customized ordering, Decorative Appliance Panels may not be returned.

Custom Panels & Doors (DAPNL.. and DADOOR..) square footage requirements are calculated by multiplying the height and width for each panel and door (square footage = width x height (in inches)/144). Premium finish upcharge will be applied.

**Custom Panels**

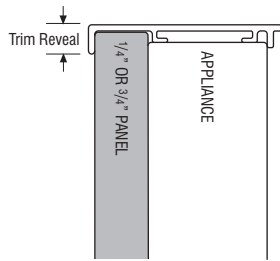

**DAPNL1/4  
DAPNL3/4**

- DAPNL1/4 includes 1/4" finished veneer on MDF core, panel cut to fit appliance doors. Panels mount to the appliance using trim kits provided by the appliance supplier.
- DAPNL1/4 is finished on face only, edges are not finished.
- DAPNL3/4 kit includes 3/4" furniture board core veneer panel finished on both sides, and all four edges. Panel is cut to fit appliance doors, and mounts to the appliance using trim kits provided by the appliance supplier.
- Custom sizes available in 1/16" increments.
- DAPNL3/4 can be ordered in APC.

	Maximum Width	Minimum Width	Maximum Height	Minimum Height
DAPNL1/4	48"	5"	96"	5"
DAPNL3/4*	48"	5"	48"	5"
DAPNL3/4**	30"	5"	96"	5"

\*If DAPNL3/4 is 48" high or less  
 \*\*If DAPNL3/4 is greater than 48" high  
 Grain on panels will follow the height dimension (vertical)

**Finish Techniques**

Distressing	Heirlooming
-------------	-------------

**Species Availability (Wood)**

Alder	Rustic Alder	Cherry	Rustic Hickory	Maple	Oak
•	•	•	•	•	•

**Species Availability (All Laminates)**

High Gloss	Horiz. Grain on Maple	Vert. Grain on Maple	Vert. Grain on Cherry	Vert. Grain on Oak
box color	box color	box color	box color	box color

**DESCRIPTION MODEL**

**Custom Panels, Premium**

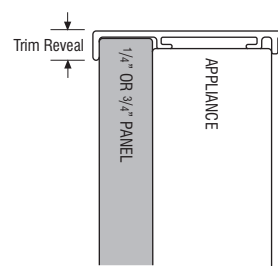

**DAPNL1/4P  
DAPNL3/4P  
DAPNL1/4HGP  
DAPNL3/4HGP**

- DAPNL1/4P and DAPNL1/4HGP are 1/4" thick laminated MDF panels cut to fit appliance doors. Laminated on face only, edges are not finished.
- DAPNL3/4P and DAPNL3/4HGP are 3/4" thick laminated MDF panels. Vertical and horizontal grain panels are laminated on both sides with edgebanding on all four edges. High Gloss panels have high gloss on front of panel, back of panel is white laminate. Edgebanding on all four edges will match door and drawer front edgebanding selection.
- DAPNL1/4P and DAPNL3/4P are available for use with Door 36 or Door 37 featuring vertical grain or with Door 25 featuring high gloss.
- DAPNL1/4HGP and DAPNL3/4HGP are available for use with Door 33 featuring horizontal grain.
- Panel is cut to fit appliance doors, and mounts to the appliance using trim kits provided by the appliance supplier.
- Custom sizes available in 1/16" increments.

Model	Panel Type	Maximum Width	Minimum Width	Maximum Height	Minimum Height
DAPNL1/4P	Vertical Grain or High Gloss	48"	5"	96"	5"
DAPNL3/4P (48" high or less)	Vertical Grain or High Gloss	48"	5"	48"	5"
DAPNL3/4P (>48" high)	Vertical Grain or High Gloss	30"	5"	96"	5"
DAPNL1/4HGP	Horizontal Grain	96"	5"	48"	5"
DAPNL3/4HGP	Horizontal Grain	48"	5"	48"	5"
DAPNL3/4HGP (>48" wide)	Horizontal Grain	96"	5"	30"	5"

**Finish Techniques**

Distressing	Heirlooming
-------------	-------------

**Species Availability (Wood)**

Alder	Rustic Alder	Cherry	Rustic Hickory	Maple	Oak
•	•	•	•	•	•

**Species Availability (All Laminates)**

High Gloss	Horiz. Grain on Maple	Vert. Grain on Maple	Vert. Grain on Cherry	Vert. Grain on Oak
•	•*	•	•	•

\*Only available on DAPNL1/4HGP and DAPNL3/4HGP.

**DESCRIPTION**

**MODEL**

**Custom Doors, No Hinge Routing**

Overlay Application (with Backer Panel)

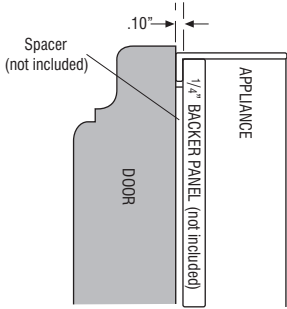

Overlay Application (no Backer Panel)

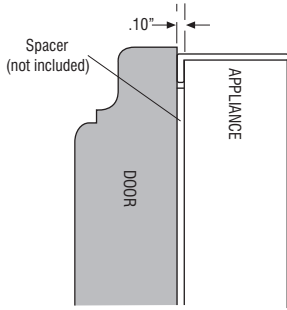

Framed Application

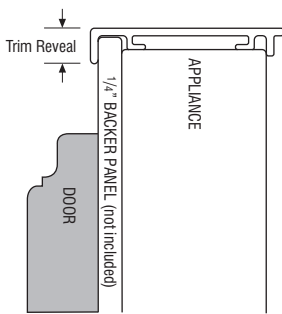

**DADOORB**

**DADOORHG**

- DADOORB is a custom sized door with a vertical grain center panel.
- DADOORHG is a custom sized door with a horizontal grain center panel. Stiles and rails are built as doors with a single center panel.
- DADOORHG will utilize a flat panel on raised panel styles when width or height is less than 10".
- Includes a 3/4" thick door made to a custom size for the appliance front. No backer panel included.
  - Some appliances require a .10" spacer and/or a 1/4" backer panel.
  - The 1/4" backer panel may be ordered separately (see DAPNL1/4).
- All doors will be specified "NO HINGE ROUTE". Backs may have identification marks, be unfinished, and have 3/16" diameter holes used during finish processing. For these reasons, these doors are not suitable for use as cabinet doors.
- DADOORB not available in Door 19, Door 25, Door 33, Door 36, Door 37, and Door 44. DADOORHG not available in Door 19, Door 25, Door 33, Door 36, Door 37, Door 44, and Door 46. For Decorative Appliance Panels, standard door sizes must be ordered.
- Custom sizes available in 1/16" increments.
- CG modification available, maximum size is 23 1/2" x 43" for DADOORB and 43" x 23 1/2" for DADOORHG.
- Not available on MDF door styles. If desired for use with MDF, order as Maple.

**Finish Techniques**

Distressing	Heirlooming
•	•

	Model	Door Style Type	Available Width Range*	Available Height Range*
	DADOORB	Non-Miter Styles	7 1/2" to 25 7/8" ** (<3" wide rails/stiles) 8 1/2" to 25 7/8" (3" wide rails/stiles)	7 1/2" to 47 7/16" (<3" wide rails/stiles) 8 1/2" to 47 7/16" (3" wide rails/stiles)
	DADOORB	Non-Miter Styles	7 1/2" to 25 7/8" ** (<3" wide rails/stiles) 8 1/2" to 25 7/8" (3" wide rails/stiles)	47 1/2" to 82" (<3" wide rails/stiles) 47 1/2" to 82" (3" wide rails/stiles)
	DADOORB	Non-Miter Styles	25 15/16" to 35 3/4" (<3" wide rails/stiles) 25 15/16" to 35 3/4" (3" wide rails/stiles)	7 1/2" to 47 7/16" (<3" wide rails/stiles) 8 1/2" to 47 7/16" (3" wide rails/stiles)
	DADOORB	Non-Miter Styles	25 15/16" to 35 3/4" (<3" wide rails/stiles) 25 15/16" to 35 3/4" (3" wide rails/stiles)	47 1/2" to 82" (<3" wide rails/stiles) 47 1/2" to 82" (3" wide rails/stiles)
	DADOORB	Miter Styles	8" to 25 7/8"	8" to 61"
	DADOORHG	Non-Miter Styles	7 1/2" to 42 1/4" (<3" wide rails/stiles) 8 1/2" to 42 1/4" (3" wide rails/stiles)	7 1/2" to 23 3/4" (<3" wide rails/stiles) 8 1/2" to 23 3/4" (3" wide rails/stiles)
	DADOORHG	Miter Styles	8" to 61"	8" to 24"

\*Any door with a minimum width or height dimension less than 10" will receive a flat center panel.  
 \*\*DADOORB in Door 46 has a maximum width of 23 1/2" for a single width center panel, doors between 23 9/16" and 35 3/4" wide have a center mullion between the center panels.

Custom Drawer Fronts

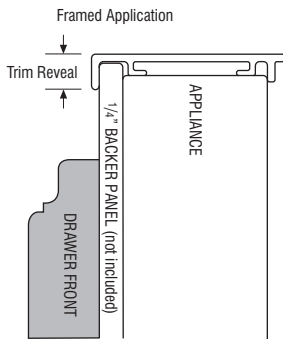
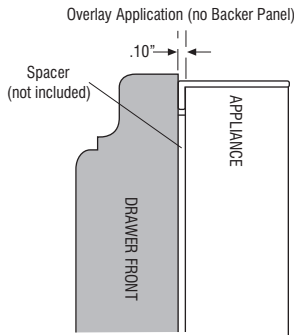
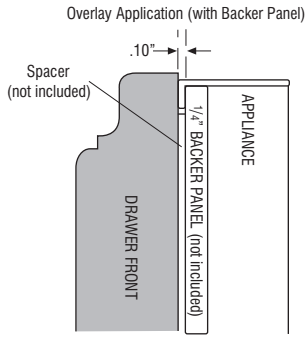

5-piece Drawer Fronts:  
DASPCDF

- DASPCDF is a custom sized 5-piece drawer front with a flat panel on raised panel styles when width or height is less than 10".
- DASPCDF is available on door styles where 5-piece drawer fronts are available as standard or optional. Requires a 5-piece drawer front selection, see chart below for available options.
- DASPCDF not available in miter door styles, MDF door styles, Door 31, Door 37, and Door 43.
- Includes a 3/4" thick drawer front made to a custom size for the appliance front. No backer panel included.
  - Some appliances require a .10" spacer and/or a 1/4" backer panel.
  - The 1/4" backer panel may be ordered separately (see DAPNL1/4).
- Backs may have identification marks and have 3/16" diameter holes used during finish processing.
- Custom sizes available in 1/16" increments.

Slab Drawer Fronts:  
DASLBDF

- DASLBDF is a custom sized slab drawer front.
- DASLBDF is available on door styles where slab drawer fronts are available as standard or optional. Requires a slab drawer front selection, see chart below for available options.
- DASLBDF not available in Door 35 and Door 44.
- Includes a 3/4" thick drawer front made to a custom size for the appliance front. No backer panel included.
  - Some appliances require a .10" spacer and/or a 1/4" backer panel.
  - The 1/4" backer panel may be ordered separately (see DAPNL1/4).
- Backs may have identification marks and have 3/16" diameter holes used during finish processing.
- Custom sizes available in 1/16" increments.

Finish Techniques

Distressing	Heirlooming
•	•

	Model	Drawer Front Type	Available Width Range	Available Height Range
	DASPCDF *	5-piece Drawer Front Non-Miter Styles	8 1/2" to 35 1/2" **	6 1/4" to 16 1/2"
	DASLBDF ***	Slab Drawer Front	7" to 47 1/2"	5 1/2" to 17"

\*Grain direction is vertical on Door 15 DFF5PCNR and Door 46.

\*\*Maximum width on Door 46 is 23 1/2".

\*\*\*Grain direction is vertical on Door 19 and Door 36.

Drawer Front Options

	DFF5PC	DFR5PC	DFF5PCNR	DFSLB	DFF5PCSLBT	DFR5PCSLBT	DFF5PCNRST	DFSLBT
DASPCDF	•	•	•	•	•	•	•	•
DASLBDF				•	•	•	•	•

# DECORATIVE APPLIANCE PANEL ORDER FORM

Use one order form per appliance.

Refer to Spec Book for door style availability, door style limitations and center panel configurations.

## STEP 1: Provide Order Information\*

Account #: \_\_\_\_\_  
 Date: \_\_\_\_\_  
 Bill To: \_\_\_\_\_

PO #: \_\_\_\_\_  
 Order #: \_\_\_\_\_  
 Ship To: \_\_\_\_\_

## STEP 2: Appliance Application or No Appliance\* — Circle Choice (For appliance applications, circle one appliance type below per order form)

Appliance Brand Name and Model Number \_\_\_\_\_

Refrigerator/Freezer

<b>Single Door</b> 	<b>Side-by-Side</b> 	<b>Side-by-Side w/Dispenser</b> 	<b>Side-by-Side w/Dispenser &amp; TV</b> 	<b>Top/Bottom</b> 	<b>Top/Bottom w/Drawers</b> 	<b>French Door</b> 	<b>Under Counter</b> 
<b>Single Door w/Grill</b> 	<b>Side-by-Side w/Grill</b> 	<b>Side-by-Side w/Dispenser &amp; Grill</b> 	<b>Side-by-Side w/Dispenser/TV &amp; Grill</b> 	<b>Top/Bottom w/Grill</b> 		<b>French Door w/Dispenser</b> 	<b>Under Counter w/Drawers</b> 

Dishwasher/Trash Compactor/  
Ice Maker/Wine Cooler

<b>Dishwasher Standard</b> 	<b>Dishwasher Standard</b> 	<b>Trash Compactor/ Ice Maker</b> 
<b>Dishwasher Double Drawer</b> 	<b>Dishwasher Single Drawer</b> 	<b>Wine Cooler</b> 

## STEP 3: Provide Dimensions in Inches\*

Custom Panels — Dimensions for Custom Size Panel(s) and/or Door(s)

DAPNL1/4, DAPNL1/4P, DAPNL3/4, DAPNL3/4P, DAPNL1/4HGP, or DAPNL3/4HGP — Circle Choice

A \_\_\_\_\_ in. width x \_\_\_\_\_ in. height = \_\_\_\_\_ square inches  
 B \_\_\_\_\_ in. width x \_\_\_\_\_ in. height = \_\_\_\_\_ square inches  
 C \_\_\_\_\_ in. width x \_\_\_\_\_ in. height = \_\_\_\_\_ square inches  
 D \_\_\_\_\_ in. width x \_\_\_\_\_ in. height = \_\_\_\_\_ square inches  
 E \_\_\_\_\_ in. width x \_\_\_\_\_ in. height = \_\_\_\_\_ square inches

} total square inches

Standard or Custom Doors and Drawer Fronts

Standard Door Sizes — Dimensions for Panels with Standard Sizes (Chosen by Manufacturer)

\*Supply overall dimensions (width and height for each panel only). Doors will be selected by manufacturer to best fit panel dimensions.

DADOORB, DADOORHG, DA5PCDF, and DASLBDF — Provide Choice Below For Each Line

1 \_\_\_\_\_ in. width x \_\_\_\_\_ in. height = \_\_\_\_\_ square inches  
 2 \_\_\_\_\_ in. width x \_\_\_\_\_ in. height = \_\_\_\_\_ square inches  
 3 \_\_\_\_\_ in. width x \_\_\_\_\_ in. height = \_\_\_\_\_ square inches  
 4 \_\_\_\_\_ in. width x \_\_\_\_\_ in. height = \_\_\_\_\_ square inches  
 5 \_\_\_\_\_ in. width x \_\_\_\_\_ in. height = \_\_\_\_\_ square inches

} total square inches

## STEP 4: Determine Price\* (Refer to Price Book for cost per square foot)

Total square inches from Step 3  ÷ 144 square inches = total square footage x \$  cost per square foot = \$

Total Cost

## STEP 5: Customer Signature\*

\*\*If premium finish is used, multiply total cost by premium upcharge percentage = \$

I accept full responsibility for the accuracy of the design above. Signature:\*

\*ALL FIELDS REQUIRED TO PROCESS ORDER.

**CUSTOM HINGED DOORS**

**Custom Doors with Hinge Routing**

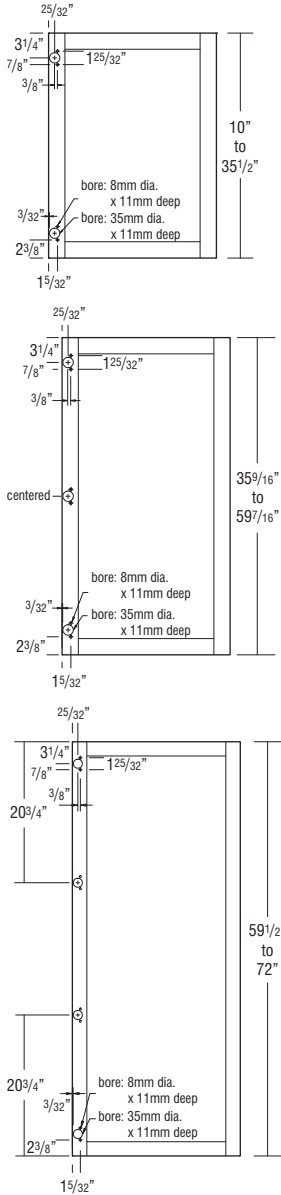

**DOORBL**

**DOORBR**

- Plastic mollies pressed in 8mm holes to accept screws to anchor the hinges to the back of these doors.
- Hinges must be ordered separately and specified as full overlay.
- Available in all door styles except Door 19, Door 25, Door 33, Door 36, Door 37, and Door 44. For Door 25, Door 33, and Door 36, use DOORSLAB (see page 331). For Door 19, Door 37, and Door 44, standard door sizes must be ordered.
- Doors are finished on both sides and routed for hinges.
- CG modification available, maximum size is 23 1/2" x 43".
- Custom dimensions are required when placing the order and can be specified in 20/20.
- Not available on MDF door styles. If desired for use with MDF, order as Maple.

**Finish Techniques**

Distressing	Heirlooming
•	•

	Door Style Type	Available Width Range*	Available Height Range
	Non-Miter Styles	7 1/2" to 24" (<3" wide rails/stiles)  8 1/2" to 24" (3" wide rails/stiles)	10" to 47 7/16" (<3" wide rails/stiles)  10" to 47 7/16" (3" wide rails/stiles)
	Non-Miter Styles	7 1/2" to 24" (<3" wide rails/stiles)  8 1/2" to 24" (3" wide rails/stiles)	47 1/2" to 72" (<3" wide rails/stiles)  47 1/2" to 72" (3" wide rails/stiles)
	Miter Styles	8" to 24"	10" to 61"

\*Any door with a minimum width dimension less than 10" will receive a flat center panel.



**Custom Doors with Hinge Routing, Slab Styles**

**DOORSLAB**

- Available in slab door styles: Door 19, Door 25, Door 33, and Door 36.
- Doors are finished on both sides and routed for hinges.
- Hinges must be ordered separately and specified full overlay.
- Plastic mollies pressed in 8mm holes to accept screws to anchor the hinges to the back of these doors.
- Custom dimensions are required when placing the order and can be specified in 20/20.

**Finish Techniques**

Distressing	Heirlooming
-------------	-------------

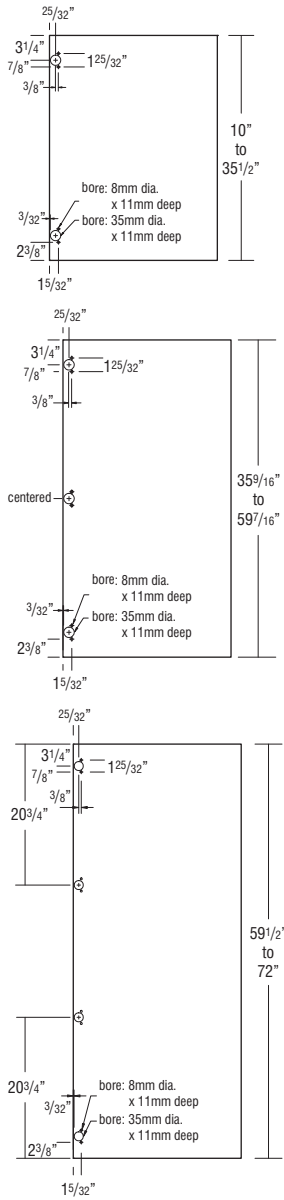

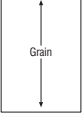
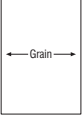
	Door Style Type	Available Width Range	Available Height Range
	Vertical Grain or High Gloss	5" to 24"	10" to 72"
	Horizontal Grain	5" to 24"	10" to 48"



All embellishments marked with the ☆ follow these guidelines:

### Program Details

- Products are shown with availability and exceptions noted. Finish technique upcharges apply.
- Items will be shipped loose for field attachment.

### Product Characteristics

- Natural characteristics of wood carved items are wider color range, irregularity of surface texture, and more noticeable variations in finish. It is imperative to understand the variations these characteristics entail and therefore will not be considered defective.

### Ordering Process

- To ensure product ships with the cabinet order, include on same order. Orders not placed together may not ship together.
- Express Response program is available for 12 day delivery.
- Must specify wood species, finish, and technique, if different than the rest of the order.
- Since these items are ordered on an "as-required" basis, **no changes or cancellations will be accepted after 24 hours from acknowledgment of order.**

### MOULDING SPECIFICATIONS

Mouldings specified as 8' nominal length have a usable length range of 93" up to 99". Mouldings specified as 10' nominal length have a usable length range of 117" up to 123". Be sure to order the correct amount of moulding length to work around required cuts with minimal butt joints.

## DESCRIPTION

## MODEL

### CROWN MOULDING

#### CLASSIC TALL CROWN



#### CLTCROWN8

#### CLTCROWN10 ♦

- CLTCROWN8 is one 8' section.
- CLTCROWN10 is one 10' section. 5 day Express Response not available.
- Cleat shipped unattached, can be used for top mount or face frame applications. For top mount applications on stained finishes, it is not recommended to pull the moulding forward with the cleat visible due to possible color variation with the face frame and moulding.

#### Finish Techniques

Distressing	Heirlooming
•	•

#### Species Availability (Wood)

	Rustic Alder	Cherry	Rustic Hickory	Maple	Oak
•	•	•	•	•	•

♦ Only available in Cherry and Maple.

#### Species Availability (All Laminates)

High Gloss	Horiz. Grain on Maple	Vert. Grain on Maple	Vert. Grain on Cherry	Vert. Grain on Oak
box color	box color	box color	box color	box color

♦ Only available in Cherry and Maple box colors.

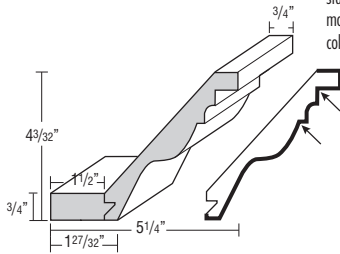

## DESCRIPTION

## MODEL

#### CORNICE TALL CROWN

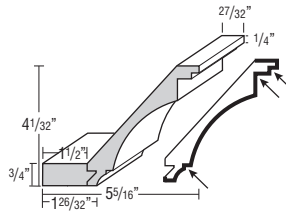

#### COTCROWN8

#### COTCROWN10 ♦

- COTCROWN8 is one 8' section.
- COTCROWN10 is one 10' section. 5 day Express Response not available.
- Cleat shipped unattached, can be used for top mount or face frame applications. For top mount applications on stained finishes, it is not recommended to pull the moulding forward with the cleat visible due to possible color variation with the face frame and moulding.

#### Finish Techniques

Distressing	Heirlooming
•	•

#### Species Availability (Wood)

	Rustic Alder	Cherry	Rustic Hickory	Maple	Oak
•	•	•	•	•	•

♦ Only available in Cherry and Maple.

#### Species Availability (All Laminates)

High Gloss	Horiz. Grain on Maple	Vert. Grain on Maple	Vert. Grain on Cherry	Vert. Grain on Oak
box color	box color	box color	box color	box color

♦ Only available in Cherry and Maple box colors.

#### COVE CROWN

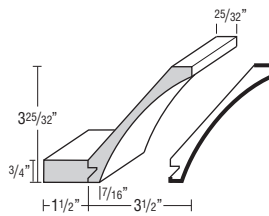

#### COVECROWN8

#### COVECROWN10 ♦

- COVECROWN8 is one 8' section.
- COVECROWN10 is one 10' section. 5 day Express Response not available.
- Cleat shipped unattached, can be used for top mount or face frame applications. For top mount applications on stained finishes, it is not recommended to pull the moulding forward with the cleat visible due to possible color variation with the face frame and moulding.

#### Finish Techniques

Distressing	Heirlooming
•	•

#### Species Availability (Wood)

	Rustic Alder	Cherry	Rustic Hickory	Maple	Oak
•	•	•	•	•	•

♦ Only available in Cherry and Maple.

#### Species Availability (All Laminates)

High Gloss	Horiz. Grain on Maple	Vert. Grain on Maple	Vert. Grain on Cherry	Vert. Grain on Oak
box color	box color	box color	box color	box color

♦ Only available in Cherry and Maple box colors.

#### FULL OVERLAY CROWN

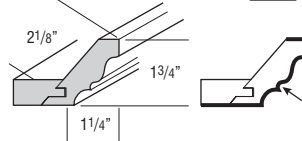

#### FOLCROWN8

- One 8' section.
- Attached cleat for top-mount application.

#### Finish Techniques

Distressing	Heirlooming
	•

#### Species Availability (Wood)

	Rustic Alder	Cherry	Rustic Hickory	Maple	Oak
•	•	•	•	•	•

#### Species Availability (All Laminates)

High Gloss	Horiz. Grain on Maple	Vert. Grain on Maple	Vert. Grain on Cherry	Vert. Grain on Oak
box color	box color	box color	box color	box color

Finished edges indicated by bold lines on side view drawings.  
Glazed edges indicated by arrows on side view drawings.

**DESCRIPTION**

**INSERT CROWN**

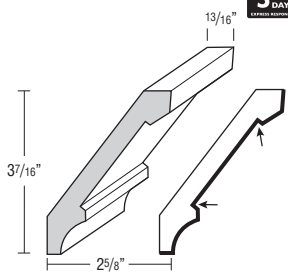

**MODEL**

**INSCROWN8**

- One 8" section.
- Designed for use with all 2 1/4" insert mouldings.

**Finish Techniques**

Distressing	Heirlooming
•	•

**Species Availability (Wood)**

Rustic Alder	Cherry	Rustic Hickory	Maple	Oak
• Alder	•	• Hickory	•	•

**Species Availability (All Laminates)**

High Gloss box color	Horiz. Grain on Maple box color	Vert. Grain on Maple box color	Vert. Grain on Cherry box color	Vert. Grain on Oak box color
----------------------	---------------------------------	--------------------------------	---------------------------------	------------------------------

**DESCRIPTION**

**STRAIGHT ANGLE CROWN**

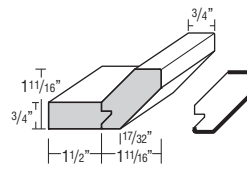

**MODEL**

**SACROWN8  
SACROWN10 ♦**

- SACROWN8 is one 8" section.
- SACROWN10 is one 10" section. 5 day Express Response not available.
- Cleat shipped unattached, can be used for top mount or face frame applications. For top mount applications on stained finishes, it is not recommended to pull the moulding forward with the cleat visible due to possible color variation with the face frame and moulding.

**Finish Techniques**

Distressing	Heirlooming
•	•

**Species Availability (Wood)**

Rustic Alder	Cherry	Rustic Hickory	Maple	Oak
• Alder	•	• Hickory	•	•

♦ Only available in Cherry and Maple.

**Species Availability (All Laminates)**

High Gloss box color	Horiz. Grain on Maple box color	Vert. Grain on Maple box color	Vert. Grain on Cherry box color	Vert. Grain on Oak box color
----------------------	---------------------------------	--------------------------------	---------------------------------	------------------------------

♦ Only available in Cherry and Maple box colors.

**LARGE STRAIGHT ANGLE CROWN**

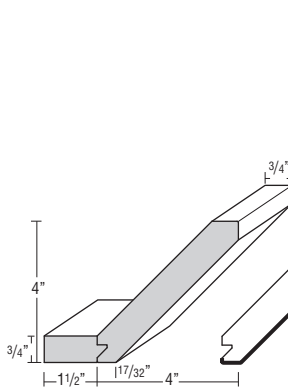

**LSACROWN8  
LSACROWN10 ♦**

- LSACROWN8 is one 8" section.
- LSACROWN10 is one 10" section. 5 day Express Response not available.
- Cleat shipped unattached, can be used for top mount or face frame applications. For top mount applications on stained finishes, it is not recommended to pull the moulding forward with the cleat visible due to possible color variation with the face frame and moulding.

**Finish Techniques**

Distressing	Heirlooming
•	•

**Species Availability (Wood)**

Rustic Alder	Cherry	Rustic Hickory	Maple	Oak
• Alder	•	• Hickory	•	•

♦ Only available in Cherry and Maple.

**Species Availability (All Laminates)**

High Gloss box color	Horiz. Grain on Maple box color	Vert. Grain on Maple box color	Vert. Grain on Cherry box color	Vert. Grain on Oak box color
----------------------	---------------------------------	--------------------------------	---------------------------------	------------------------------

♦ Only available in Cherry and Maple box colors.

**TALL CROWN**

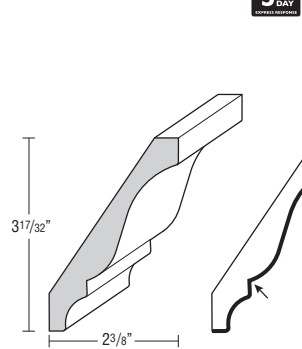

**MTCROWN8  
MTCROWN10 ♦**

- MTCROWN8 is one 8" section.
- MTCROWN10 is one 10" section. 5 day Express Response not available.

**Finish Techniques**

Distressing	Heirlooming
•	•

**Species Availability (Wood)**

Rustic Alder	Cherry	Rustic Hickory	Maple	Oak
• Alder	•	• Hickory	•	•

♦ Only available in Cherry and Maple.

**Species Availability (All Laminates)**

High Gloss box color	Horiz. Grain on Maple box color	Vert. Grain on Maple box color	Vert. Grain on Cherry box color	Vert. Grain on Oak box color
----------------------	---------------------------------	--------------------------------	---------------------------------	------------------------------

♦ Only available in Cherry and Maple box colors.

**MEDIUM STRAIGHT ANGLE CROWN**

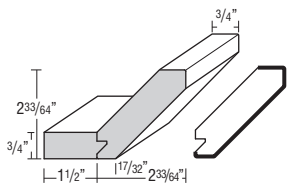

**MSACROWN8  
MSACROWN10 ♦**

- MSACROWN8 is one 8" section.
- MSACROWN10 is one 10" section. 5 day Express Response not available.
- Cleat shipped unattached, can be used for top mount or face frame applications. For top mount applications on stained finishes, it is not recommended to pull the moulding forward with the cleat visible due to possible color variation with the face frame and moulding.

**Finish Techniques**

Distressing	Heirlooming
•	•

**Species Availability (Wood)**

Rustic Alder	Cherry	Rustic Hickory	Maple	Oak
• Alder	•	• Hickory	•	•

♦ Only available in Cherry and Maple.

**Species Availability (All Laminates)**

High Gloss box color	Horiz. Grain on Maple box color	Vert. Grain on Maple box color	Vert. Grain on Cherry box color	Vert. Grain on Oak box color
----------------------	---------------------------------	--------------------------------	---------------------------------	------------------------------

♦ Only available in Cherry and Maple box colors.

**SHAKER CROWN**

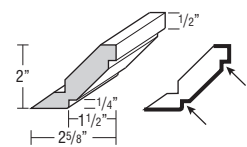

**SHKCRM8**

- Top mount moulding.
- One 8" section.

**Finish Techniques**

Distressing	Heirlooming
•	•

**Species Availability (Wood)**

Rustic Alder	Cherry	Rustic Hickory	Maple	Oak
• Alder	•	• Hickory	•	•

**Species Availability (All Laminates)**

High Gloss box color	Horiz. Grain on Maple box color	Vert. Grain on Maple box color	Vert. Grain on Cherry box color	Vert. Grain on Oak box color
----------------------	---------------------------------	--------------------------------	---------------------------------	------------------------------

Finished edges indicated by bold lines on side view drawings.  
Glazed edges indicated by arrows on side view drawings.

DESCRIPTION

MODEL

LARGE SHAKER CROWN

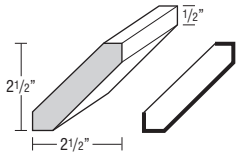

LSHAKER8  
LSHAKER10 ♦

- LSHAKER8 is one 8' section.
- LSHAKER10 is one 10' section. 5 day Express Response not available.

**Finish Techniques**

Distressing	Heirlooming
•	•

**Species Availability (Wood)**

Rustic Alder	Rustic Alder	Cherry	Rustic Hickory	Maple	Oak
•	•	•	•	•	•

♦ Only available in Cherry and Maple.

**Species Availability (All Laminates)**

High Gloss	Horiz. Grain on Maple	Vert. Grain on Maple	Vert. Grain on Cherry	Vert. Grain on Oak
•	•	•	•	•

♦ Only available in Cherry and Maple box colors.

LARGE SHAKER CROWN, PREMIUM

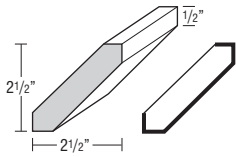

LSHAKER8P  
LSHAKER10P

- LSHAKER8P is one 8' section.
- LSHAKER10P is one 10' section. 5 day Express Response not available.
- Horizontal grain except on High Gloss.

**Finish Techniques**

Distressing	Heirlooming
•	•

**Species Availability (Wood)**

Rustic Alder	Rustic Alder	Cherry	Rustic Hickory	Maple	Oak
•	•	•	•	•	•

**Species Availability (All Laminates)**

High Gloss	Horiz. Grain on Maple	Vert. Grain on Maple	Vert. Grain on Cherry	Vert. Grain on Oak
•	•	•*	•*	•*

\*LSHAKER10P not available in Laminate AJ and Laminate AK.

SMALL COVE CROWN MOULDING

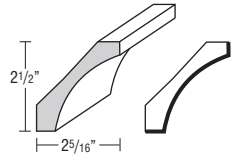

SMCOVECROWN8  
SMCOVECROWN10 ♦

- SMCOVECROWN8 is one 8' section.
- SMCOVECROWN10 is one 10' section. 5 day Express Response not available.

**Finish Techniques**

Distressing	Heirlooming
•	•

**Species Availability (Wood)**

Rustic Alder	Rustic Alder	Cherry	Rustic Hickory	Maple	Oak
•	•	•	•	•	•

♦ Only available in Cherry and Maple.

**Species Availability (All Laminates)**

High Gloss	Horiz. Grain on Maple	Vert. Grain on Maple	Vert. Grain on Cherry	Vert. Grain on Oak
•	•	•	•	•

♦ Only available in Cherry and Maple box colors.

DESCRIPTION

MODEL

SMALL CROWN



SCM8  
SCM10 ♦

- May be face mounted if used with a cleat.
- SCM8 is one 8' section.
- SCM10 is one 10' section. 5 day Express Response not available.
- Moulding can be used as standard or inverted.

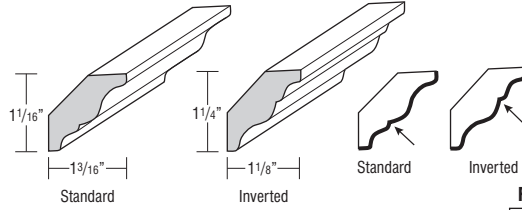

**Finish Techniques**

Distressing	Heirlooming
•	•

**Species Availability (Wood)**

Rustic Alder	Rustic Alder	Cherry	Rustic Hickory	Maple	Oak
•	•	•	•	•	•

♦ Only available in Cherry and Maple.

**Species Availability (All Laminates)**

High Gloss	Horiz. Grain on Maple	Vert. Grain on Maple	Vert. Grain on Cherry	Vert. Grain on Oak
•	•	•	•	•

♦ Only available in Cherry and Maple box colors.

SOLID-WOOD CROWN



SWCRM8  
SWCRM10 ♦

- May be face mounted if used with a cleat.
- SWCRM8 is one 8' section.
- SWCRM10 is one 10' section. 5 day Express Response not available.
- Moulding can be used as standard or inverted.

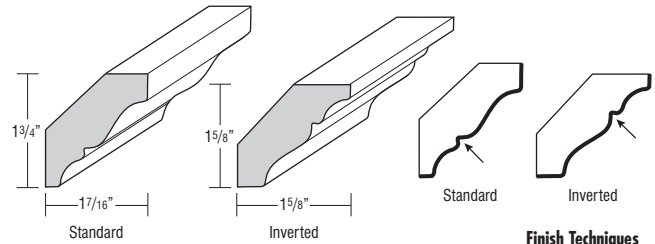

**Finish Techniques**

Distressing	Heirlooming
•	•

**Species Availability (Wood)**

Rustic Alder	Rustic Alder	Cherry	Rustic Hickory	Maple	Oak
•	•	•	•	•	•

♦ Only available in Cherry and Maple.

**Species Availability (All Laminates)**

High Gloss	Horiz. Grain on Maple	Vert. Grain on Maple	Vert. Grain on Cherry	Vert. Grain on Oak
•	•	•	•	•

♦ Only available in Cherry and Maple box colors.

Finished edges indicated by bold lines on side view drawings.  
Glazed edges indicated by arrows on side view drawings.

**DESCRIPTION**

**MODEL**

**SOLID-WOOD LARGE CROWN**



**SWLCRM8  
SWLCRM10 ♦**

- May be face mounted if used with a cleat.
- SWLCRM8 is one 8" section.
- SWLCRM10 is one 10" section. 5 day Express Response not available.
- Moulding can be used as standard or inverted.

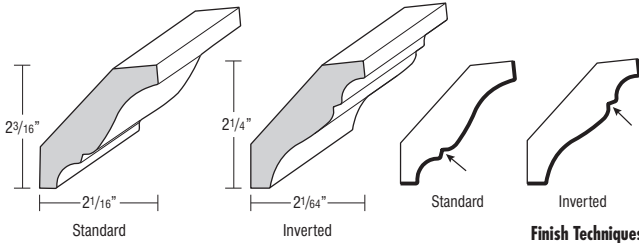

**Finish Techniques**

Distressing	Heirlooming
•	•

**Species Availability (Wood)**

Rustic Alder	Rustic Alder	Cherry	Rustic Hickory	Maple	Oak
• Alder	• Alder	•	• Hickory	•	•

♦ Only available in Cherry and Maple.

**Species Availability (All Laminates)**

High Gloss box color	Horiz. Grain on Maple box color	Vert. Grain on Maple box color	Vert. Grain on Cherry box color	Vert. Grain on Oak box color
----------------------	---------------------------------	--------------------------------	---------------------------------	------------------------------

♦ Only available in Cherry and Maple box colors.

**SOLID-WOOD TALL CROWN**



**SWTCRM8  
SWTCRM10 ♦**

- May be face mounted if used with a cleat.
- SWTCRM8 is one 8" section.
- SWTCRM10 is one 10" section. 5 day Express Response not available.
- Moulding can be used as standard or inverted.

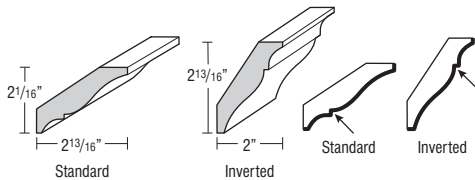

**Finish Techniques**

Distressing	Heirlooming
•	•

**Species Availability (Wood)**

Rustic Alder	Rustic Alder	Cherry	Rustic Hickory	Maple	Oak
• Alder	• Alder	•	• Hickory	•	•

♦ Only available in Cherry and Maple.

**Species Availability (All Laminates)**

High Gloss box color	Horiz. Grain on Maple box color	Vert. Grain on Maple box color	Vert. Grain on Cherry box color	Vert. Grain on Oak box color
----------------------	---------------------------------	--------------------------------	---------------------------------	------------------------------

♦ Only available in Cherry and Maple box colors.

**DESCRIPTION**

**MODEL**

**SOLID-WOOD VICTORIAN CROWN**



**SWVCRM8  
SWVCRM10 ♦**

- May be face mounted if used with a cleat.
- Designed for braided, dentil, egg & dart, or rope moulding application.
- SWVCRM8 is one 8" section.
- SWVCRM10 is one 10" section. 5 day Express Response not available.

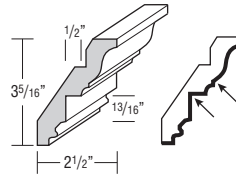

**Finish Techniques**

Distressing	Heirlooming
•	•

**Species Availability (Wood)**

Rustic Alder	Rustic Alder	Cherry	Rustic Hickory	Maple	Oak
• Alder	• Alder	•	• Hickory	•	•

♦ Only available in Cherry and Maple.

**Species Availability (All Laminates)**

High Gloss box color	Horiz. Grain on Maple box color	Vert. Grain on Maple box color	Vert. Grain on Cherry box color	Vert. Grain on Oak box color
----------------------	---------------------------------	--------------------------------	---------------------------------	------------------------------

♦ Only available in Cherry and Maple box colors.

**STARTER MOULDINGS**

**SOFFIT FILLER MOULDING**



**SFM8  
SFM10 ♦**

- SFM8 is one 8" section.
- SFM10 is one 10" section. 5 day Express Response not available.
- Cleat shipped unattached, can be used for top mount or face frame applications. For top mount applications on stained finishes, it is not recommended to pull the moulding forward with the cleat visible due to possible color variation with the face frame and moulding.

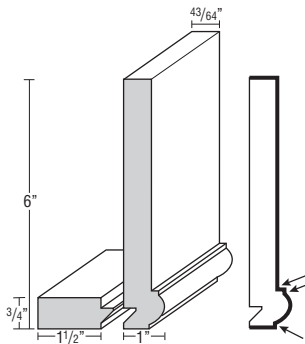

**Finish Techniques**

Distressing	Heirlooming
•	•

**Species Availability (Wood)**

Rustic Alder	Rustic Alder	Cherry	Rustic Hickory	Maple	Oak
• Alder	• Alder	•	• Hickory	•	•

♦ Only available in Cherry and Maple.

**Species Availability (All Laminates)**

High Gloss box color	Horiz. Grain on Maple box color	Vert. Grain on Maple box color	Vert. Grain on Cherry box color	Vert. Grain on Oak box color
----------------------	---------------------------------	--------------------------------	---------------------------------	------------------------------

♦ Only available in Cherry and Maple box colors.

**STARTER MOULDING**



**STR8  
STR10 ♦**

- STR8 is one 8" section.
- STR10 is one 10" section. 5 day Express Response not available.
- Attached cleat for top-mount application.

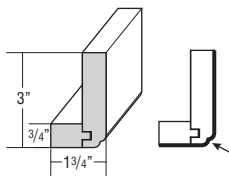

**Finish Techniques**

Distressing	Heirlooming
•	•

**Species Availability (Wood)**

Rustic Alder	Rustic Alder	Cherry	Rustic Hickory	Maple	Oak
• Alder	• Alder	•	• Hickory	•	•

♦ Only available in Cherry and Maple.

**Species Availability (All Laminates)**

High Gloss box color	Horiz. Grain on Maple box color	Vert. Grain on Maple box color	Vert. Grain on Cherry box color	Vert. Grain on Oak box color
----------------------	---------------------------------	--------------------------------	---------------------------------	------------------------------

♦ Only available in Cherry and Maple box colors.

Finished edges indicated by bold lines on side view drawings.  
Glazed edges indicated by arrows on side view drawings.

DESCRIPTION

MODEL

STARTER MOULDING, SHAKER

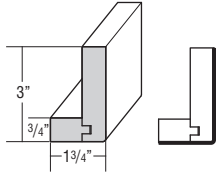

STRS8

STRS10 ♦

- STRS8 is one 8" section.
- STRS10 is one 10" section. 5 day Express Response not available.
- Attached cleat for top-mount application.

Finish Techniques

Distressing	Heirlooming
•	•

Species Availability (Wood)

Rustic Alder	Rustic Alder	Cherry	Rustic Hickory	Maple	Oak
•	•	•	•	•	•

♦ Only available in Cherry and Maple.

Species Availability (All Laminates)

High Gloss box color	Horiz. Grain on Maple box color	Vert. Grain on Maple box color	Vert. Grain on Cherry box color	Vert. Grain on Oak box color
•	•	•	•	•

♦ Only available in Cherry and Maple box colors.

STARTER MOULDING, SHAKER PREMIUM

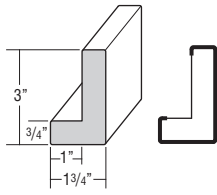

STRS8P

- One 8" section.
- Horizontal grain except on High Gloss.

Finish Techniques

Distressing	Heirlooming
•	•

Species Availability (Wood)

Rustic Alder	Rustic Alder	Cherry	Rustic Hickory	Maple	Oak
•	•	•	•	•	•

Species Availability (All Laminates)

High Gloss	Horiz. Grain on Maple	Vert. Grain on Maple	Vert. Grain on Cherry	Vert. Grain on Oak
•	•	•	•	•

MOULDING INSERTS

BRAIDED

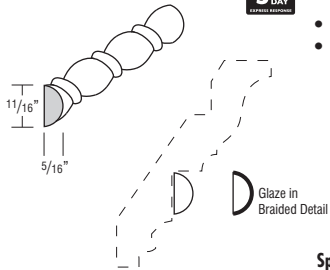

BRAIDM

- Designed to face mount on SWVCRM8.
- One 8" section.

Finish Techniques

Distressing	Heirlooming
•	•

Species Availability (Wood)

Rustic Alder	Rustic Alder	Cherry	Rustic Hickory	Maple	Oak
•	•	•	•	•	•

Species Availability (All Laminates)

High Gloss box color	Horiz. Grain on Maple box color	Vert. Grain on Maple box color	Vert. Grain on Cherry box color	Vert. Grain on Oak box color
•	•	•	•	•

DESCRIPTION

MODEL

CELTIC INSERT

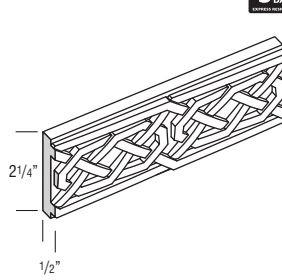

INSERTCELT

- One 8" section.
- Designed to be used with Insert Crown.
- Pattern is 6" repeat.

Finish Techniques

Distressing	Heirlooming
•	•

Species Availability (Wood)

Rustic Alder	Rustic Alder	Cherry	Rustic Hickory	Maple	Oak
•	•	•	•	•	•

Species Availability (All Laminates)

High Gloss box color	Horiz. Grain on Maple box color	Vert. Grain on Maple box color	Vert. Grain on Cherry box color	Vert. Grain on Oak box color
•	•	•	•	•

DENTIL

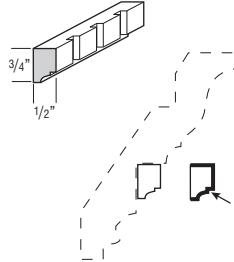

MDENTIL8

- Designed to face mount on SWVCRM8.
- One 8" section.

Finish Techniques

Distressing	Heirlooming
•	•

Species Availability (Wood)

Rustic Alder	Rustic Alder	Cherry	Rustic Hickory	Maple	Oak
•	•	•	•	•	•

Species Availability (All Laminates)

High Gloss box color	Horiz. Grain on Maple box color	Vert. Grain on Maple box color	Vert. Grain on Cherry box color	Vert. Grain on Oak box color
•	•	•	•	•

EGG & DART

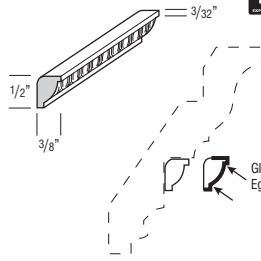

EGD8

- Designed to face mount on SWVCRM8.
- One 8" section.

Finish Techniques

Distressing	Heirlooming
•	•

Species Availability (Wood)

Rustic Alder	Rustic Alder	Cherry	Rustic Hickory	Maple	Oak
•	•	•	•	•	•

Species Availability (All Laminates)

High Gloss box color	Horiz. Grain on Maple box color	Vert. Grain on Maple box color	Vert. Grain on Cherry box color	Vert. Grain on Oak box color
•	•	•	•	•

ROPE

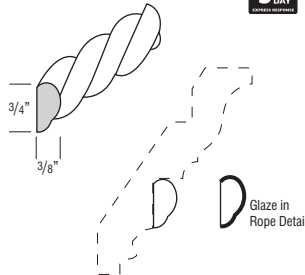

RPM8

- Designed to face mount on SWVCRM8.
- One 8" section.

Finish Techniques

Distressing	Heirlooming
•	•

Species Availability (Wood)

Rustic Alder	Rustic Alder	Cherry	Rustic Hickory	Maple	Oak
•	•	•	•	•	•

Species Availability (All Laminates)

High Gloss box color	Horiz. Grain on Maple box color	Vert. Grain on Maple box color	Vert. Grain on Cherry box color	Vert. Grain on Oak box color
•	•	•	•	•

Finished edges indicated by bold lines on side view drawings.  
Glazed edges indicated by arrows on side view drawings.

**DESCRIPTION**  
**ACCENT MOULDING**

**MODEL**

**ACANTHUS**

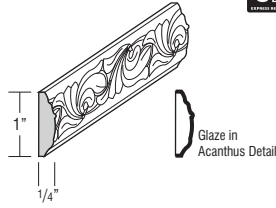

**ACAM**

- One 8' section.

**Finish Techniques**

Distressing	Heirloom
	•

**Species Availability (Wood)**

Rustic Alder	Rustic Alder	Cherry	Rustic Hickory	Maple	Oak
• Alder	• Alder	• Cherry	• Hickory	• Beech	• Beech

**Species Availability (All Laminates)**

High Gloss box color	Horiz. Grain on Maple box color	Vert. Grain on Maple box color	Vert. Grain on Cherry box color	Vert. Grain on Oak	Beech
----------------------	---------------------------------	--------------------------------	---------------------------------	--------------------	-------

**BACK PANEL MOULDING**



**BPM8**

- One 8' section.
- Designed to provide a decorative edge between cabinet and panel-corner seam.

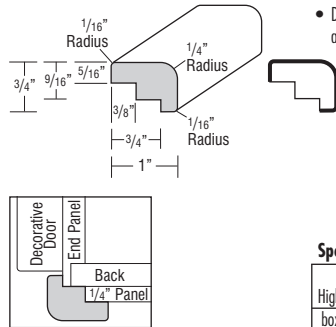

**Finish Techniques**

Distressing	Heirloom
	•

**Species Availability (Wood)**

Rustic Alder	Rustic Alder	Cherry	Rustic Hickory	Maple	Oak
• Alder	• Alder	• Cherry	• Hickory	• Maple	• Oak

**Species Availability (All Laminates)**

High Gloss box color	Horiz. Grain on Maple box color	Vert. Grain on Maple box color	Vert. Grain on Cherry box color	Vert. Grain on Oak
----------------------	---------------------------------	--------------------------------	---------------------------------	--------------------

**CABINET PANEL EDGE**



**CPE8**

- One 8' section.

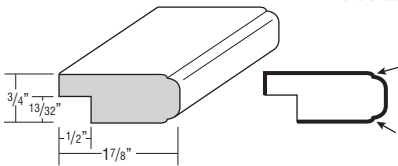

**Finish Techniques**

Distressing	Heirloom
	•

**Species Availability (Wood)**

Rustic Alder	Rustic Alder	Cherry	Rustic Hickory	Maple	Oak
• Alder	• Alder	• Cherry	• Hickory	• Maple	• Oak

**Species Availability (All Laminates)**

High Gloss box color	Horiz. Grain on Maple box color	Vert. Grain on Maple box color	Vert. Grain on Cherry box color	Vert. Grain on Oak
----------------------	---------------------------------	--------------------------------	---------------------------------	--------------------

**COUNTERTOP EDGE**



**CCM8**

**Contemporary**

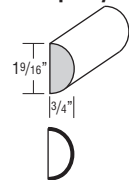

**Traditional**

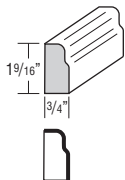

**TCM8**

- One 8' section.

**Finish Techniques**

Distressing	Heirloom
	•*

\*Available on TCM8 only

**Species Availability (Wood)**

Rustic Alder	Rustic Alder	Cherry	Rustic Hickory	Maple	Oak
• Alder	• Alder	• Cherry	• Hickory	• Maple	• Oak

**Species Availability (All Laminates)**

High Gloss box color	Horiz. Grain on Maple box color	Vert. Grain on Maple box color	Vert. Grain on Cherry box color	Vert. Grain on Oak
----------------------	---------------------------------	--------------------------------	---------------------------------	--------------------

**DESCRIPTION**

**MODEL**

**BATTEN**

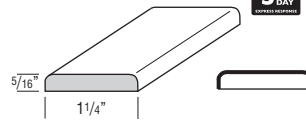

**BATTEN8**

- One 8' section.

**Finish Techniques**

Distressing	Heirloom
	•

**Species Availability (Wood)**

Rustic Alder	Rustic Alder	Cherry	Rustic Hickory	Maple	Oak
• Alder	• Alder	• Cherry	• Hickory	• Maple	• Oak

**Species Availability (All Laminates)**

High Gloss box color	Horiz. Grain on Maple box color	Vert. Grain on Maple box color	Vert. Grain on Cherry box color	Vert. Grain on Oak
----------------------	---------------------------------	--------------------------------	---------------------------------	--------------------

**FLAT SCRIBE**

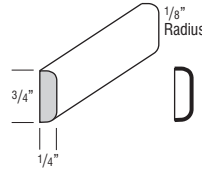

**SM8**

**SM10 ♦**

- SM8 is one 8' section.
- SM10 is one 10' section. 5 day Express Response not available.

**Finish Techniques**

Distressing	Heirloom
	•

**Species Availability (Wood)**

Rustic Alder	Rustic Alder	Cherry	Rustic Hickory	Maple	Oak
• Alder	• Alder	• Cherry	• Hickory	• Maple	• Oak

♦ Only available in Cherry and Maple.

**Species Availability (All Laminates)**

High Gloss box color	Horiz. Grain on Maple box color	Vert. Grain on Maple box color	Vert. Grain on Cherry box color	Vert. Grain on Oak
----------------------	---------------------------------	--------------------------------	---------------------------------	--------------------

♦ Only available in Cherry and Maple box colors.

**FLAT SCRIBE, PREMIUM**

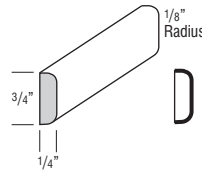

**SM8P**

**SM10P**

- SM8P is one 8' section.
- SM10P is one 10' section. 5 day Express Response not available.
- Horizontal grain except on High Gloss.

**Finish Techniques**

Distressing	Heirloom
	•

**Species Availability (Wood)**

Rustic Alder	Rustic Alder	Cherry	Rustic Hickory	Maple	Oak
• Alder	• Alder	• Cherry	• Hickory	• Maple	• Oak

**Species Availability (All Laminates)**

High Gloss	Horiz. Grain on Maple	Vert. Grain on Maple	Vert. Grain on Cherry	Vert. Grain on Oak
•	•	•*	•*	•*

\*SM10P not available in Laminate AJ and Laminate AK.

Finished edges indicated by bold lines on side view drawings.  
Glazed edges indicated by arrows on side view drawings.

DESCRIPTION

MODEL

LIBRARY MOULDING



LBRM

- One 8' section.

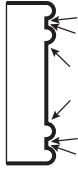
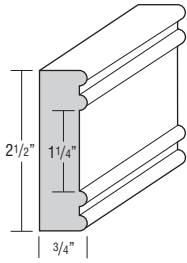

Finish Techniques

Distressing	Heirloom
•	•

Species Availability (Wood)

	Rustic Alder	Cherry	Rustic Hickory	Maple	Oak
•	•	•	•	•	•

Species Availability (All Laminates)

High Gloss box color	Horiz. Grain on Maple box color	Vert. Grain on Maple box color	Vert. Grain on Cherry box color	Vert. Grain on Oak box color
----------------------	---------------------------------	--------------------------------	---------------------------------	------------------------------

MIRROR FRAME



WMF8

- Pre-grooved.
- One 8' section.

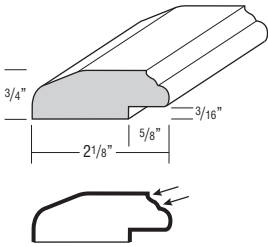

Finish Techniques

Distressing	Heirloom
•	•

Species Availability (Wood)

	Rustic Alder	Cherry	Rustic Hickory	Maple	Oak
•	•	•	•	•	•

Species Availability (All Laminates)

High Gloss box color	Horiz. Grain on Maple box color	Vert. Grain on Maple box color	Vert. Grain on Cherry box color	Vert. Grain on Oak box color
----------------------	---------------------------------	--------------------------------	---------------------------------	------------------------------

OGEE EDGE



OGEE

- One 8' section.

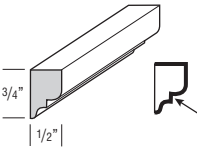

Finish Techniques

Distressing	Heirloom
•	•

Species Availability (Wood)

	Rustic Alder	Cherry	Rustic Hickory	Maple	Oak
•	•	•	•	•	•

Species Availability (All Laminates)

High Gloss box color	Horiz. Grain on Maple box color	Vert. Grain on Maple box color	Vert. Grain on Cherry box color	Vert. Grain on Oak box color
----------------------	---------------------------------	--------------------------------	---------------------------------	------------------------------

SINGLE BEAD EDGE



SBE8

- One 8' section.

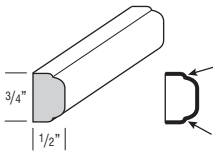

Finish Techniques

Distressing	Heirloom
•	•

Species Availability (Wood)

	Rustic Alder	Cherry	Rustic Hickory	Maple	Oak
•	•	•	•	•	•

Species Availability (All Laminates)

High Gloss box color	Horiz. Grain on Maple box color	Vert. Grain on Maple box color	Vert. Grain on Cherry box color	Vert. Grain on Oak box color
----------------------	---------------------------------	--------------------------------	---------------------------------	------------------------------

DESCRIPTION

MODEL

SINGLE BEAD MOULDING



SBM8

- One 8' section.

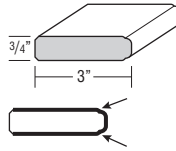

Finish Techniques

Distressing	Heirloom
•	•

Species Availability (Wood)

	Rustic Alder	Cherry	Rustic Hickory	Maple	Oak
•	•	•	•	•	•

Species Availability (All Laminates)

High Gloss box color	Horiz. Grain on Maple box color	Vert. Grain on Maple box color	Vert. Grain on Cherry box color	Vert. Grain on Oak box color
----------------------	---------------------------------	--------------------------------	---------------------------------	------------------------------

SINGLE BEAD PILASTER



SBP8

- One 8' section.
- Can be used vertically between cabinets for an inset look.

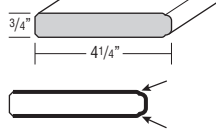

Finish Techniques

Distressing	Heirloom
•	•

Species Availability (Wood)

	Rustic Alder	Cherry	Rustic Hickory	Maple	Oak
•	•	•	•	•	•

Species Availability (All Laminates)

High Gloss box color	Horiz. Grain on Maple box color	Vert. Grain on Maple box color	Vert. Grain on Cherry box color	Vert. Grain on Oak box color
----------------------	---------------------------------	--------------------------------	---------------------------------	------------------------------

SMALL SCRIBE



SCRIBE8

SCRIBE10 ♦

- SCRIBE8 is one 8' section.
- SCRIBE10 is one 10' section. 5 day Express Response not available.

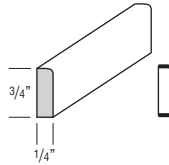

Finish Techniques

Distressing	Heirloom
•	•

Species Availability (Wood)

	Rustic Alder	Cherry	Rustic Hickory	Maple	Oak
•	•	•	•	•	•

♦ Only available in Cherry and Maple.

Species Availability (All Laminates)

High Gloss box color	Horiz. Grain on Maple box color	Vert. Grain on Maple box color	Vert. Grain on Cherry box color	Vert. Grain on Oak box color
----------------------	---------------------------------	--------------------------------	---------------------------------	------------------------------

♦ Only available in Cherry and Maple box colors.

Finished edges indicated by bold lines on side view drawings.  
Glazed edges indicated by arrows on side view drawings.



**DESCRIPTION**

**MODEL**

**SMALL SCRIBE, PREMIUM**



**SSM8P**  
**SSM10P**

- SSM8P is one 8" section.
- SSM10P is one 10" section. 5 day Express Response not available.
- Horizontal grain except on High Gloss.

**Finish Techniques**

Distressing	Heirlooming
-------------	-------------

**Species Availability (Wood)**

Rustic Alder	Rustic Alder	Cherry	Rustic Hickory	Maple	Oak
•	•	•	•	•	•

**Species Availability (All Laminates)**

High Gloss	Horiz. Grain on Maple	Vert. Grain on Maple	Vert. Grain on Cherry	Vert. Grain on Oak
•	•	•*	•*	•*

\*SSM10P not available in Laminate AJ and Laminate AK.

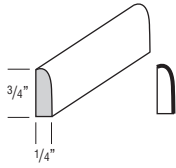

**SOFFIT TRIM MOULDING**



**TSTM8**  
**TSTM10 ♦**

- TSTM8 is one 8" section.
- TSTM10 is one 10" section. 5 day Express Response not available.

**Finish Techniques**

Distressing	Heirlooming
-------------	-------------

**Species Availability (Wood)**

Rustic Alder	Rustic Alder	Cherry	Rustic Hickory	Maple	Oak
•	•	•	•	•	•

♦ Only available in Cherry and Maple.

**Species Availability (All Laminates)**

High Gloss	Horiz. Grain on Maple	Vert. Grain on Maple	Vert. Grain on Cherry	Vert. Grain on Oak
box color	box color	box color	box color	box color

♦ Only available in Cherry and Maple box colors.

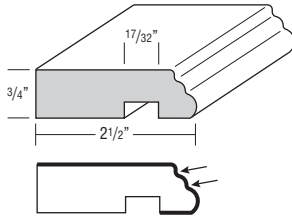

**TRIPLE BEAD EDGE**



**TBEM**

- One 8" section.

**Finish Techniques**

Distressing	Heirlooming
-------------	-------------

**Species Availability (Wood)**

Rustic Alder	Rustic Alder	Cherry	Rustic Hickory	Maple	Oak
•	•	•	•	•	•

**Species Availability (All Laminates)**

High Gloss	Horiz. Grain on Maple	Vert. Grain on Maple	Vert. Grain on Cherry	Vert. Grain on Oak
box color	box color	box color	box color	box color

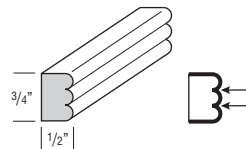

**DESCRIPTION**

**MODEL**

**TRIPLE BEAD PILASTER**



**TBP8**

- Finished beaded front and two 4 1/2" sides.
- Can be used vertically between cabinets for an inset look.
- One 8" section.

**Finish Techniques**

Distressing	Heirlooming
-------------	-------------

**Species Availability (Wood)**

Rustic Alder	Rustic Alder	Cherry	Rustic Hickory	Maple	Oak
•	•	•	•	•	•

**Species Availability (All Laminates)**

High Gloss	Horiz. Grain on Maple	Vert. Grain on Maple	Vert. Grain on Cherry	Vert. Grain on Oak
box color	box color	box color	box color	box color

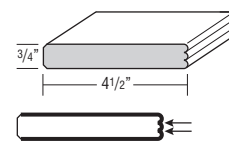

**WIDE SCRIBE**



**WSCRIBE**

- One 8" section.

**Finish Techniques**

Distressing	Heirlooming
-------------	-------------

**Species Availability (Wood)**

Rustic Alder	Rustic Alder	Cherry	Rustic Hickory	Maple	Oak
•	•	•	•	•	•

**Species Availability (All Laminates)**

High Gloss	Horiz. Grain on Maple	Vert. Grain on Maple	Vert. Grain on Cherry	Vert. Grain on Oak
box color	box color	box color	box color	box color

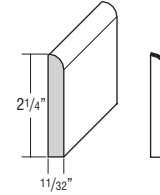

**UNDER PANEL MOULDING**



**UPM8**

- One 8" section.
- Can be used on edges of 1/4" thick panels to conceal end grain.

**Finish Techniques**

Distressing	Heirlooming
-------------	-------------

**Species Availability (Wood)**

Rustic Alder	Rustic Alder	Cherry	Rustic Hickory	Maple	Oak
•	•	•	•	•	•

**Species Availability (All Laminates)**

High Gloss	Horiz. Grain on Maple	Vert. Grain on Maple	Vert. Grain on Cherry	Vert. Grain on Oak
box color	box color	box color	box color	box color

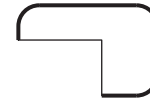
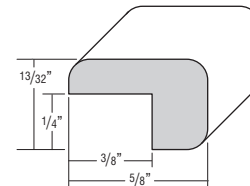

**UNDER PANEL MOULDING, PREMIUM**



**UPM8P**

- One 8" section.
- Horizontal grain except on High Gloss.
- Can be used on edges of 1/4" thick panels to conceal end grain.

**Finish Techniques**

Distressing	Heirlooming
-------------	-------------

**Species Availability (Wood)**

Rustic Alder	Rustic Alder	Cherry	Rustic Hickory	Maple	Oak
•	•	•	•	•	•

**Species Availability (All Laminates)**

High Gloss	Horiz. Grain on Maple	Vert. Grain on Maple	Vert. Grain on Cherry	Vert. Grain on Oak
•	•	•	•	•

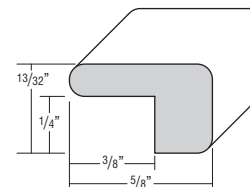

Finished edges indicated by bold lines on side view drawings.  
Glazed edges indicated by arrows on side view drawings.

**DESCRIPTION**  
**TOE MOULDING**

**MODEL**

**BASEBOARD**

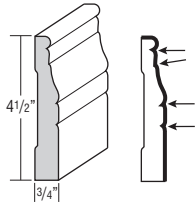

**BBM8**  
**BBM10 ♦**

- BBM8 is one 8" section.
- BBM10 is one 10" section. 5 day Express Response not available.
- BBM8 can be used in place of standard toekick to provide a surface for glaze hang-up on premium finishes.

**Finish Techniques**

Distressing	Heirlooming
•	•

**Species Availability (Wood)**

	Rustic Alder	Cherry	Rustic Hickory	Maple	Oak
•	Alder	•	Hickory	•	•

♦ Only available in Cherry and Maple.

**Species Availability (All Laminates)**

High Gloss	Horiz. Grain on Maple	Vert. Grain on Maple	Vert. Grain on Cherry	Vert. Grain on Oak
box color	box color	box color	box color	box color

♦ Only available in Cherry and Maple box colors.

**BASEBOARD - FURNITURE**

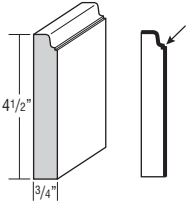

**BBMFB8**

- One 8" section.

**Finish Techniques**

Distressing	Heirlooming
•	•

**Species Availability (Wood)**

	Rustic Alder	Cherry	Rustic Hickory	Maple	Oak
•	Alder	•	Hickory	•	•

**Species Availability (All Laminates)**

High Gloss	Horiz. Grain on Maple	Vert. Grain on Maple	Vert. Grain on Cherry	Vert. Grain on Oak
box color	box color	box color	box color	box color

**BASEBOARD - SCULPTED**

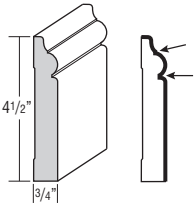

**BBMSC**

- One 8" section.
- BBMSC can be used in place of standard toekick to provide a surface for glaze hang-up on premium finishes.

**Finish Techniques**

Distressing	Heirlooming
•	•

**Species Availability (Wood)**

	Rustic Alder	Cherry	Rustic Hickory	Maple	Oak
•	Alder	•	Hickory	•	•

**Species Availability (All Laminates)**

High Gloss	Horiz. Grain on Maple	Vert. Grain on Maple	Vert. Grain on Cherry	Vert. Grain on Oak
box color	box color	box color	box color	box color

**DESCRIPTION**

**MODEL**

**BASEBOARD - SHAKER**

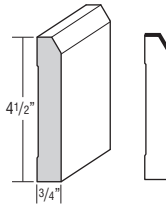

**BBMSH8**

**BBMSH10 ♦**

- BBMSH8 is one 8" section.
- BBMSH10 is one 10" section. 5 day Express Response not available.

**Finish Techniques**

Distressing	Heirlooming
•	•

**Species Availability (Wood)**

	Rustic Alder	Cherry	Rustic Hickory	Maple	Oak
•	Alder	•	Hickory	•	•

♦ Only available in Cherry and Maple.

**Species Availability (All Laminates)**

High Gloss	Horiz. Grain on Maple	Vert. Grain on Maple	Vert. Grain on Cherry	Vert. Grain on Oak
box color	box color	box color	box color	box color

♦ Only available in Cherry and Maple box colors.

**BASEBOARD - SWOOPED**

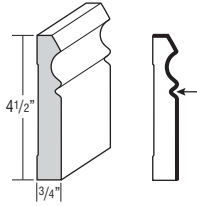

**BBMSW**

- One 8" section.
- BBMSW can be used in place of standard toekick to provide a surface for glaze hang-up on premium finishes.

**Finish Techniques**

Distressing	Heirlooming
•	•

**Species Availability (Wood)**

	Rustic Alder	Cherry	Rustic Hickory	Maple	Oak
•	Alder	•	Hickory	•	•

**Species Availability (All Laminates)**

High Gloss	Horiz. Grain on Maple	Vert. Grain on Maple	Vert. Grain on Cherry	Vert. Grain on Oak
box color	box color	box color	box color	box color

Finished edges indicated by bold lines on side view drawings.  
Glazed edges indicated by arrows on side view drawings.

**DESCRIPTION**

**MODEL**

**TOEBOARDS**



- TB8LAM18** ♦
- TB8WD14**
- TB8LAM12** ♦

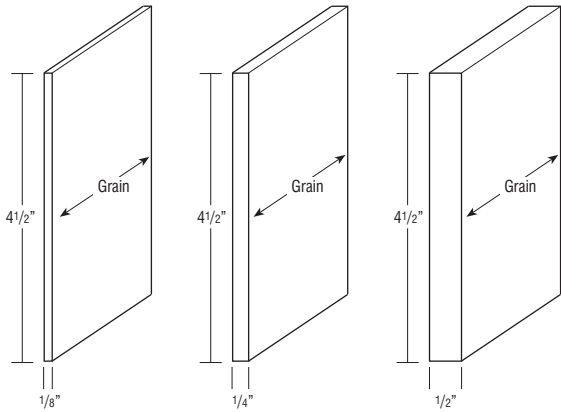

- TB8LAM18 is 1/8" laminated furniture board (White only).
- TB8WD14 in Stains: 1/4" thick veneered furniture board.
- TB8WD14 in Paints: 1/4" thick veneered or solid furniture board.
- TB8LAM12 is 1/2" laminated furniture board (White only).
- One 8' section.

**Finish Techniques**

Distressing	Heirlooming
-------------	-------------

**Species Availability (Wood)**

Rustic Alder	Rustic Alder	Cherry	Rustic Hickory	Maple	Oak
•	•	•	•	•	•

♦ Only available in White Laminate.

**Species Availability (All Laminates)**

High Gloss box color	Horiz. Grain on Maple box color	Vert. Grain on Maple box color	Vert. Grain on Cherry box color	Vert. Grain on Oak box color
----------------------	---------------------------------	--------------------------------	---------------------------------	------------------------------

♦ Only available in White laminate.

**TOEBOARDS, PREMIUM**



**TB8P14**

- 1/4" thick laminated MDF.
- One 8' section.
- Horizontal grain except on High Gloss.

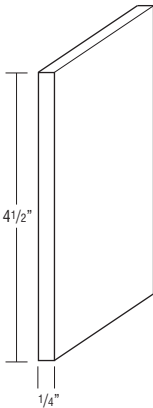

**Finish Techniques**

Distressing	Heirlooming
-------------	-------------

**Species Availability (Wood)**

Rustic Alder	Rustic Alder	Cherry	Rustic Hickory	Maple	Oak
•	•	•	•	•	•

**Species Availability (All Laminates)**

High Gloss box color	Horiz. Grain on Maple box color	Vert. Grain on Maple box color	Vert. Grain on Cherry box color	Vert. Grain on Oak box color
----------------------	---------------------------------	--------------------------------	---------------------------------	------------------------------

**TOEKICK CAP**



**TKC**

- Sold in pairs.

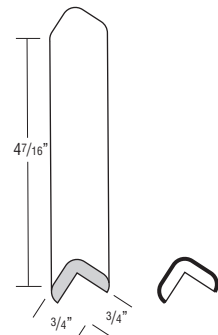

**Finish Techniques**

Distressing	Heirlooming
-------------	-------------

**Species Availability (Wood)**

Rustic Alder	Rustic Alder	Cherry	Rustic Hickory	Maple	Oak
•	•	•	•	•	•

**Species Availability (All Laminates)**

High Gloss box color	Horiz. Grain on Maple box color	Vert. Grain on Maple box color	Vert. Grain on Cherry box color	Vert. Grain on Oak box color
----------------------	---------------------------------	--------------------------------	---------------------------------	------------------------------

**DESCRIPTION**

**MODEL**

**LIGHT RAILS**

**CAP MOULDING**



**CAPM**

- One 8' section.

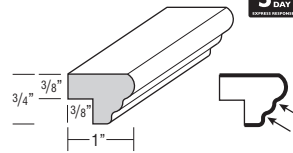

**Finish Techniques**

Distressing	Heirlooming
-------------	-------------

**Species Availability (Wood)**

Rustic Alder	Rustic Alder	Cherry	Rustic Hickory	Maple	Oak
•	•	•	•	•	•

**Species Availability (All Laminates)**

High Gloss box color	Horiz. Grain on Maple box color	Vert. Grain on Maple box color	Vert. Grain on Cherry box color	Vert. Grain on Oak box color
----------------------	---------------------------------	--------------------------------	---------------------------------	------------------------------

**CABINET PANEL EDGE SQUARE**



**CPES**

- One 8' section.
- Standard application must be shimmed at the notch or used with an under-cabinet skin if used with full overlay styles. Inverted application does not require a shim or panel.
- Standard application can be used as a top-mount moulding.

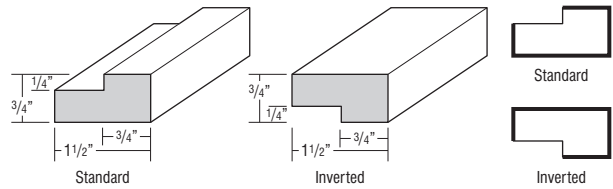

**Finish Techniques**

Distressing	Heirlooming
-------------	-------------

**Species Availability (Wood)**

Rustic Alder	Rustic Alder	Cherry	Rustic Hickory	Maple	Oak
•	•	•	•	•	•

**Species Availability (All Laminates)**

High Gloss box color	Horiz. Grain on Maple box color	Vert. Grain on Maple box color	Vert. Grain on Cherry box color	Vert. Grain on Oak box color
----------------------	---------------------------------	--------------------------------	---------------------------------	------------------------------

**FURNITURE BASE LIGHT RAIL**



**FBLR8**

- One 8' section.

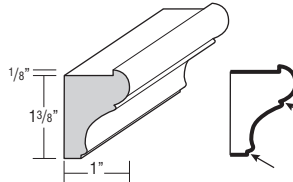

**Finish Techniques**

Distressing	Heirlooming
-------------	-------------

**Species Availability (Wood)**

Rustic Alder	Rustic Alder	Cherry	Rustic Hickory	Maple	Oak
•	•	•	•	•	•

**Species Availability (All Laminates)**

High Gloss box color	Horiz. Grain on Maple box color	Vert. Grain on Maple box color	Vert. Grain on Cherry box color	Vert. Grain on Oak box color
----------------------	---------------------------------	--------------------------------	---------------------------------	------------------------------

Finished edges indicated by bold lines on side view drawings.  
Glazed edges indicated by arrows on side view drawings.

DESCRIPTION

MODEL

LIGHT BAFFLE



LB2

- One 8' section.

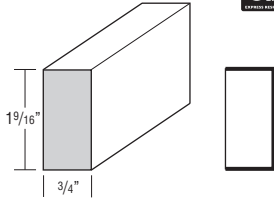

Finish Techniques

Distressing	Heirloom
	•

Species Availability (Wood)

Alder	Rustic Alder	Cherry	Rustic Hickory	Maple	Oak
•	•	•	•	•	•

Species Availability (All Laminates)

High Gloss	Horiz. Grain on Maple	Vert. Grain on Maple	Vert. Grain on Cherry	Vert. Grain on Oak
box color	box color	box color	box color	box color

LIGHT BAFFLE, PREMIUM



LB2P

- One 8' section.
- Horizontal grain except on High Gloss.

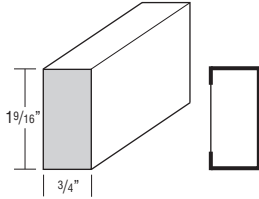

Finish Techniques

Distressing	Heirloom
	•

Species Availability (Wood)

Alder	Rustic Alder	Cherry	Rustic Hickory	Maple	Oak
•	•	•	•	•	•

Species Availability (All Laminates)

High Gloss	Horiz. Grain on Maple	Vert. Grain on Maple	Vert. Grain on Cherry	Vert. Grain on Oak
•	•	•	•	•

LIGHT RAIL CAP



SOFFITA

- One 8' section.
- Must be shimmed at the notch or used with an under-cabinet skin if used with full overlay styles.

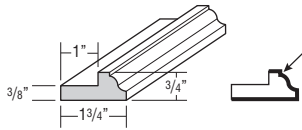

Finish Techniques

Distressing	Heirloom
	•

Species Availability (Wood)

Alder	Rustic Alder	Cherry	Rustic Hickory	Maple	Oak
•	•	•	•	•	•

Species Availability (All Laminates)

High Gloss	Horiz. Grain on Maple	Vert. Grain on Maple	Vert. Grain on Cherry	Vert. Grain on Oak
box color	box color	box color	box color	box color

LIGHT RAIL CAP - SHAKER



SOFFITE

- One 8' section.
- Must be shimmed at the notch or used with an under-cabinet skin if used with full overlay styles.

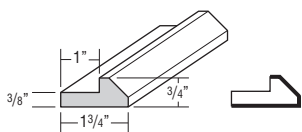

Finish Techniques

Distressing	Heirloom
	•

Species Availability (Wood)

Alder	Rustic Alder	Cherry	Rustic Hickory	Maple	Oak
•	•	•	•	•	•

Species Availability (All Laminates)

High Gloss	Horiz. Grain on Maple	Vert. Grain on Maple	Vert. Grain on Cherry	Vert. Grain on Oak
box color	box color	box color	box color	box color

DESCRIPTION

MODEL

SMALL LIGHT RAIL MOULDING



SMLR

- One 8' section.

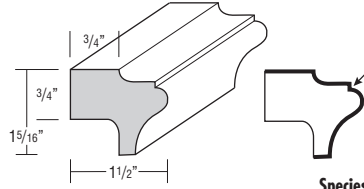

Finish Techniques

Distressing	Heirloom
•	•

Species Availability (Wood)

Alder	Rustic Alder	Cherry	Rustic Hickory	Maple	Oak
•	•	•	•	•	•

Species Availability (All Laminates)

High Gloss	Horiz. Grain on Maple	Vert. Grain on Maple	Vert. Grain on Cherry	Vert. Grain on Oak
box color	box color	box color	box color	box color

LIGHT RAIL MOULDING



LRM

- One 8' section.

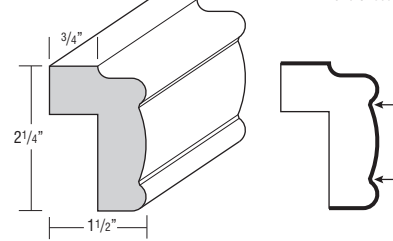

Finish Techniques

Distressing	Heirloom
•	•

Species Availability (Wood)

Alder	Rustic Alder	Cherry	Rustic Hickory	Maple	Oak
•	•	•	•	•	•

Species Availability (All Laminates)

High Gloss	Horiz. Grain on Maple	Vert. Grain on Maple	Vert. Grain on Cherry	Vert. Grain on Oak
box color	box color	box color	box color	box color

VALLEY FORGE



VFR8

- One 8' section.
- Must be shimmed at the notch or used with an under-cabinet skin if used with full overlay styles.

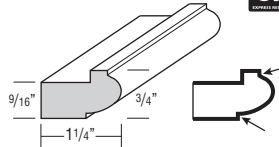

Finish Techniques

Distressing	Heirloom
	•

Species Availability (Wood)

Alder	Rustic Alder	Cherry	Rustic Hickory	Maple	Oak
•	•	•	•	•	•

Species Availability (All Laminates)

High Gloss	Horiz. Grain on Maple	Vert. Grain on Maple	Vert. Grain on Cherry	Vert. Grain on Oak
box color	box color	box color	box color	box color

TRADITIONAL LIGHT RAIL



JINSERTLRT

- One 8' section.
- Designed for use with all 3/4" insert mouldings.

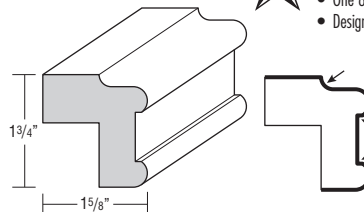

Finish Techniques

Distressing	Heirloom
	•

Species Availability (Wood)

Alder	Rustic Alder	Cherry	Rustic Hickory	Maple	Oak
•	•	•	•	•	•

Species Availability (All Laminates)

High Gloss	Horiz. Grain on Maple	Vert. Grain on Maple	Vert. Grain on Cherry	Vert. Grain on Oak
box color	box color	box color	box color	box color

Finished edges indicated by bold lines on side view drawings.  
Glazed edges indicated by arrows on side view drawings.

**DESCRIPTION**

**MODEL**

**CONTEMPORARY LIGHT RAIL**

**JINSERTLRC**

- One 8" section.
- Designed for use with all 3/4" insert mouldings.

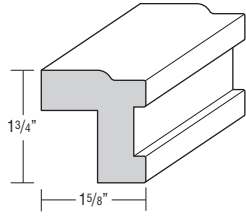

**Finish Techniques**

Distressing	Heirlooming
	•

**Species Availability (Wood)**

Rustic Alder	Cherry	Rustic Hickory	Maple	Oak
•	•	•	•	•

**Species Availability (All Laminates)**

High Gloss	Horiz. Grain on Maple	Vert. Grain on Maple	Vert. Grain on Cherry	Vert. Grain on Oak
box color	box color	box color	box color	box color

**DESCRIPTION**

**MODEL**

**INSIDE CORNER, PREMIUM**



**ICM8P**

- One 8" section.
- Horizontal grain except on High Gloss.

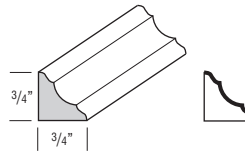

**Finish Techniques**

Distressing	Heirlooming
	•

**Species Availability (Wood)**

Rustic Alder	Cherry	Rustic Hickory	Maple	Oak
•	•	•	•	•

**Species Availability (All Laminates)**

High Gloss	Horiz. Grain on Maple	Vert. Grain on Maple	Vert. Grain on Cherry	Vert. Grain on Oak
•	•	•	•	•

**CORNER MOULDINGS**

**DIAGONAL CORNER**



**DCM8**

- Designed to set cabinets at a 45° corner application using 3/4" end panels.
- One 8" section.
- Not compatible on cabinets with Furniture Ends (FPEB) or Authentic Ends (AUTHL/AUTHR/AUTHB).

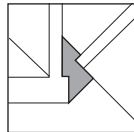
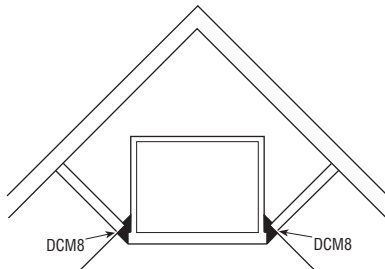
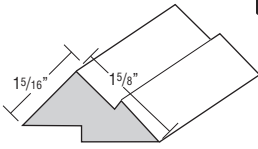

**Finish Techniques**

Distressing	Heirlooming
	•

**Species Availability (Wood)**

Rustic Alder	Cherry	Rustic Hickory	Maple	Oak
•	•	•	•	•

**Species Availability (All Laminates)**

High Gloss	Horiz. Grain on Maple	Vert. Grain on Maple	Vert. Grain on Cherry	Vert. Grain on Oak
box color	box color	box color	box color	box color

**INSIDE CORNER**



**ICM8**

- One 8" section.

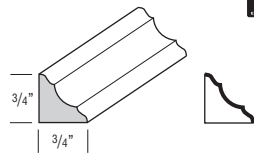

**Finish Techniques**

Distressing	Heirlooming
	•

**Species Availability (Wood)**

Rustic Alder	Cherry	Rustic Hickory	Maple	Oak
•	•	•	•	•

**Species Availability (All Laminates)**

High Gloss	Horiz. Grain on Maple	Vert. Grain on Maple	Vert. Grain on Cherry	Vert. Grain on Oak
box color	box color	box color	box color	box color

**LARGE OUTSIDE CORNER**



**LOSC8**

- One 8" section.

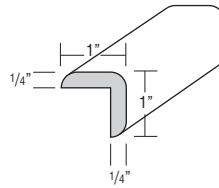

**Finish Techniques**

Distressing	Heirlooming
	•

**Species Availability (Wood)**

Rustic Alder	Cherry	Rustic Hickory	Maple	Oak
•	•	•	•	•

**Species Availability (All Laminates)**

High Gloss	Horiz. Grain on Maple	Vert. Grain on Maple	Vert. Grain on Cherry	Vert. Grain on Oak
box color	box color	box color	box color	box color

**OUTSIDE CORNER**



**OCM8**

- One 8" section.

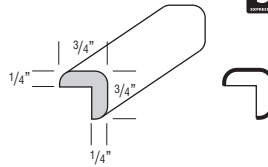

**Finish Techniques**

Distressing	Heirlooming
	•

**Species Availability (Wood)**

Rustic Alder	Cherry	Rustic Hickory	Maple	Oak
•	•	•	•	•

**Species Availability (All Laminates)**

High Gloss	Horiz. Grain on Maple	Vert. Grain on Maple	Vert. Grain on Cherry	Vert. Grain on Oak
box color	box color	box color	box color	box color

**OUTSIDE CORNER, PREMIUM**



**OCM8P**

- One 8" section.
- Horizontal grain except on High Gloss.

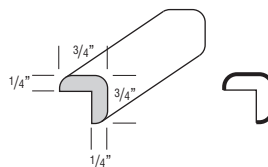

**Finish Techniques**

Distressing	Heirlooming
	•

**Species Availability (Wood)**

Rustic Alder	Cherry	Rustic Hickory	Maple	Oak
•	•	•	•	•

**Species Availability (All Laminates)**

High Gloss	Horiz. Grain on Maple	Vert. Grain on Maple	Vert. Grain on Cherry	Vert. Grain on Oak
•	•	•	•	•

Finished edges indicated by bold lines on side view drawings.  
Glazed edges indicated by arrows on side view drawings.

**DESCRIPTION** **MODEL**

**OUTSIDE CORNER 135°**



**OC135**

• One 8' section.

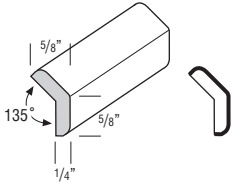

**Finish Techniques**

Distressing	Heirlooming
-------------	-------------

**Species Availability (Wood)**

Alder	Rustic Alder	Cherry	Rustic Hickory	Maple	Oak
•	Alder	•	Hickory	•	•

**Species Availability (All Laminates)**

High Gloss	Horiz. Grain on Maple	Vert. Grain on Maple	Vert. Grain on Cherry	Vert. Grain on Oak
box color	box color	box color	box color	box color

**QUARTER ROUND MOULDING**



**QRM**

• One 8' section.

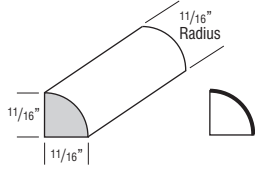

**Finish Techniques**

Distressing	Heirlooming
-------------	-------------

**Species Availability (Wood)**

Alder	Rustic Alder	Cherry	Rustic Hickory	Maple	Oak
•	Alder	•	Hickory	•	•

**Species Availability (All Laminates)**

High Gloss	Horiz. Grain on Maple	Vert. Grain on Maple	Vert. Grain on Cherry	Vert. Grain on Oak
box color	box color	box color	box color	box color

**SHOE - CONVEX INSIDE CORNER**



**SHM8**

• One 8' section.

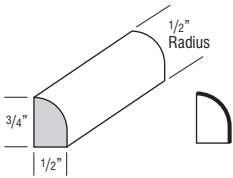

**Finish Techniques**

Distressing	Heirlooming
-------------	-------------

**Species Availability (Wood)**

Alder	Rustic Alder	Cherry	Rustic Hickory	Maple	Oak
•	Alder	•	Hickory	•	•

**Species Availability (All Laminates)**

High Gloss	Horiz. Grain on Maple	Vert. Grain on Maple	Vert. Grain on Cherry	Vert. Grain on Oak
box color	box color	box color	box color	box color

**WINDOW CASING**

**WINDOW CASING - TRADITIONAL**



**WCT8**

• One 8' section.

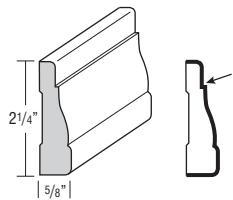

**Finish Techniques**

Distressing	Heirlooming
	•

**Species Availability (Wood)**

Alder	Rustic Alder	Cherry	Rustic Hickory	Maple	Oak
•	Alder	•	Hickory	•	•

**Species Availability (All Laminates)**

High Gloss	Horiz. Grain on Maple	Vert. Grain on Maple	Vert. Grain on Cherry	Vert. Grain on Oak
box color	box color	box color	box color	box color

Finished edges indicated by bold lines on side view drawings.  
Glazed edges indicated by arrows on side view drawings.

**DESCRIPTION**

**MODEL**

**VALANCES**

**ARCHED VALANCE**



- AV36**
- AV48**
- AV60**
- AV72**

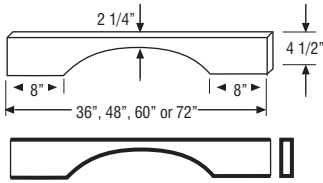

- Side shoulders are 8" wide (6" trimmable each end).
- Bottom edge has 3/16" radius.
- 3/4" thick.

**Finish Techniques**

Distressing	Heirlooming
•	•

**Species Availability (Wood)**

Rustic Alder	Rustic Alder	Cherry	Rustic Hickory	Maple	Oak
•	•	•	•	•	•

**Species Availability (All Laminates)**

High Gloss	Horiz. Grain on Maple	Vert. Grain on Maple	Vert. Grain on Cherry	Vert. Grain on Oak
box color	box color	box color	box color	box color

**FURNITURE VALANCE**



- FV36**
- FV48**
- FV60**
- FV72**

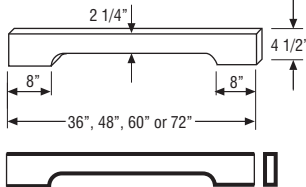

- Side shoulders are 8" wide (6" trimmable each end).
- Bottom edge has 3/16" radius profile on face.
- 3/4" thick.

**Finish Techniques**

Distressing	Heirlooming
•	•

**Species Availability (Wood)**

Rustic Alder	Rustic Alder	Cherry	Rustic Hickory	Maple	Oak
•	•	•	•	•	•

**Species Availability (All Laminates)**

High Gloss	Horiz. Grain on Maple	Vert. Grain on Maple	Vert. Grain on Cherry	Vert. Grain on Oak
box color	box color	box color	box color	box color

**RAISED PANEL ARCH VALANCE**



- JRPV30**
- JRPV36**
- JRPV42**
- JRPV48**
- JRPV54**
- JRPV60**
- JRPV72**

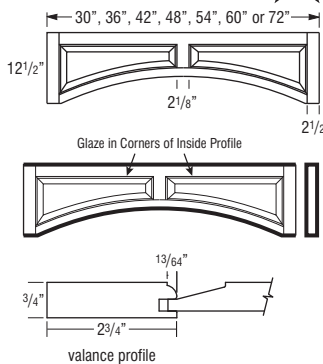

- Trimmable up to 1 3/4" per side.
- Recommended for use with hearths, see page 153.
- Center height 8".
- Raised panel profile is unique to this item and does not match any door style.
- Ends are pocket drilled for installation to adjacent cabinet frames.

**Finish Techniques**

Distressing	Heirlooming
•	•

**Species Availability (Wood)**

Rustic Alder	Rustic Alder	Cherry	Rustic Hickory	Maple	Oak
•	•	•	•	•	•

**Species Availability (All Laminates)**

High Gloss	Horiz. Grain on Maple	Vert. Grain on Maple	Vert. Grain on Cherry	Vert. Grain on Oak
box color	box color	box color	box color	box color

**DESCRIPTION**

**MODEL**

**RECESSED PANEL ARCH VALANCE**



- JRCPV30**
- JRCPV36**
- JRCPV42**
- JRCPV48**
- JRCPV54**
- JRCPV60**
- JRCPV72**

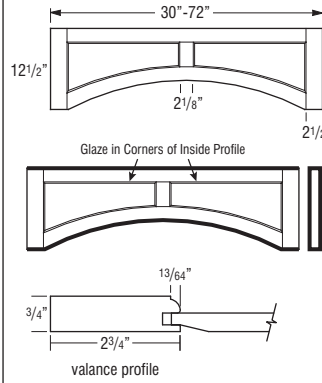

- Trimmable up to 1 3/4" per side.
- Recommended for use with hearths, see page 153.
- Center height 8".
- Ends are pocket drilled for installation to adjacent cabinet frames.

**Finish Techniques**

Distressing	Heirlooming
•	•

**Species Availability (Wood)**

Rustic Alder	Rustic Alder	Cherry	Rustic Hickory	Maple	Oak
•	•	•	•	•	•

**Species Availability (All Laminates)**

High Gloss	Horiz. Grain on Maple	Vert. Grain on Maple	Vert. Grain on Cherry	Vert. Grain on Oak
box color	box color	box color	box color	box color

**STRAIGHT VALANCE**



- VV48**
- VV72**
- VV96**
- VV120 ♦**

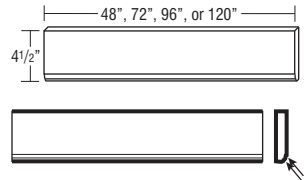

- Trimmable.
- 3/4" thick.

**Finish Techniques**

Distressing	Heirlooming
•	•

**Species Availability (Wood)**

Rustic Alder	Rustic Alder	Cherry	Rustic Hickory	Maple	Oak
•	•	•	•	•	•

♦ Only available in Cherry and Maple.

**Species Availability (All Laminates)**

High Gloss	Horiz. Grain on Maple	Vert. Grain on Maple	Vert. Grain on Cherry	Vert. Grain on Oak
box color	box color	box color	box color	box color

♦ Only available in Cherry and Maple box colors.

Finished edges indicated by bold lines on side view drawings.  
Glazed edges indicated by arrows on side view drawings.

DESCRIPTION

MODEL

DECORATIVE ORNAMENTS

MISSION ROSETTE



ROSETTEMIS

- Apply with small brad.

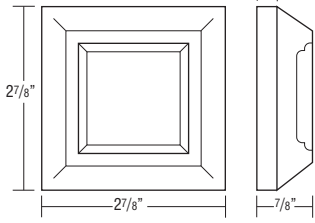

**Finish Techniques**

Distressing	Heirlooming
	•

**Species Availability (Wood)**

	Rustic Alder	Cherry	Rustic Hickory	Maple	Oak
•	Alder	•		•	

**Species Availability (All Laminates)**

High Gloss	Horiz. Grain on Maple	Vert. Grain on Maple	Vert. Grain on Cherry	Vert. Grain on Oak
box color	box color	box color	box color	box color

PLINTH BLOCK FILLER, 3"



FFP3X8 (Fluted)

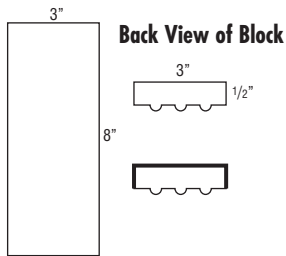

**Finish Techniques**

Distressing	Heirlooming
	•

**Species Availability (Wood)**

	Rustic Alder	Cherry	Rustic Hickory	Maple	Oak
•	Alder	•		•	•

**Species Availability (All Laminates)**

High Gloss	Horiz. Grain on Maple	Vert. Grain on Maple	Vert. Grain on Cherry	Vert. Grain on Oak
box color	box color	box color	box color	box color

DESCRIPTION

MODEL

DECORATIVE SUPPORTS

BUFFET LEG, 34 1/2" HIGH



JBUFFETLEG

- Trimmable.

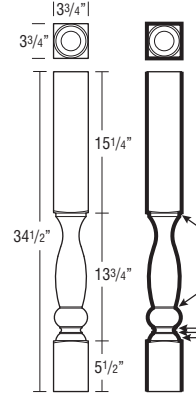

**Finish Techniques**

Distressing	Heirlooming
	•

**Species Availability (Wood)**

	Rustic Alder	Cherry	Rustic Hickory	Maple	Oak
•	Alder	•		•	•

**Species Availability (All Laminates)**

High Gloss	Horiz. Grain on Maple	Vert. Grain on Maple	Vert. Grain on Cherry	Vert. Grain on Oak
box color	box color	box color	box color	box color

BUNGALOW LEG, 3" WIDE, 34 1/2" HIGH



BUNLEG3

- Trimmable.

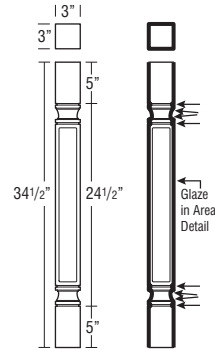

**Finish Techniques**

Distressing	Heirlooming
	•

**Species Availability (Wood)**

	Rustic Alder	Cherry	Rustic Hickory	Maple	Oak
•	Alder	•		•	•

**Species Availability (All Laminates)**

High Gloss	Horiz. Grain on Maple	Vert. Grain on Maple	Vert. Grain on Cherry	Vert. Grain on Oak
box color	box color	box color	box color	box color

BUNGALOW LEG, 5" WIDE, 34 1/2" HIGH



BUNLEG5

- Trimmable.

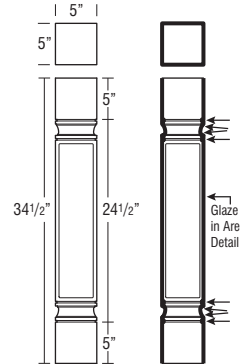

**Finish Techniques**

Distressing	Heirlooming
	•

**Species Availability (Wood)**

	Rustic Alder	Cherry	Rustic Hickory	Maple	Oak
•	Alder	•		•	•

**Species Availability (All Laminates)**

High Gloss	Horiz. Grain on Maple	Vert. Grain on Maple	Vert. Grain on Cherry	Vert. Grain on Oak
box color	box color	box color	box color	box color

Finished edges indicated by bold lines on side view drawings.  
Glazed edges indicated by arrows on side view drawings.



**DESCRIPTION**

**MODEL**

**COSMO LEG,  
35 1/4" HIGH**



**JCOSMOLEG**

- Trimmable.
- Leg is designed with three pieces joined together.

**Finish Techniques**

Distressing	Heirloom
	•

**Species Availability (Wood)**

	Rustic Alder	Cherry	Rustic Hickory	Maple	Oak
•	Alder	•		•	•

**Species Availability (All Laminates)**

High Gloss box color	Horiz. Grain on Maple box color	Vert. Grain on Maple box color	Vert. Grain on Cherry box color	Vert. Grain on Oak box color
----------------------	---------------------------------	--------------------------------	---------------------------------	------------------------------

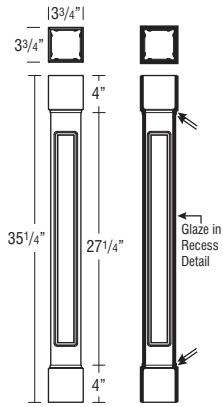

**DESCRIPTION**

**MODEL**

**ENGLISH ISLAND COLUMN,  
5" WIDE, 35 1/4" HIGH**



**ENGLISCOLUMN**

- Trimmable.

**Finish Techniques**

Distressing	Heirloom
	•

**Species Availability (Wood)**

	Rustic Alder	Cherry	Rustic Hickory	Maple	Oak
•	Alder	•		•	•

**Species Availability (All Laminates)**

High Gloss box color	Horiz. Grain on Maple box color	Vert. Grain on Maple box color	Vert. Grain on Cherry box color	Vert. Grain on Oak box color
----------------------	---------------------------------	--------------------------------	---------------------------------	------------------------------

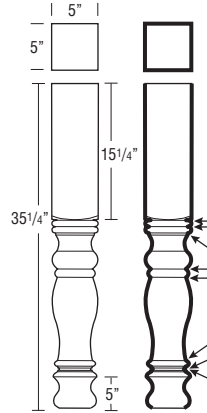

**ENGLISH COUNTRY LEG,  
35 1/4" HIGH**



**JENGCNTYLEG**

- Trimmable.

**Finish Techniques**

Distressing	Heirloom
	•

**Species Availability (Wood)**

	Rustic Alder	Cherry	Rustic Hickory	Maple	Oak
•	Alder	•		•	•

**Species Availability (All Laminates)**

High Gloss box color	Horiz. Grain on Maple box color	Vert. Grain on Maple box color	Vert. Grain on Cherry box color	Vert. Grain on Oak box color
----------------------	---------------------------------	--------------------------------	---------------------------------	------------------------------

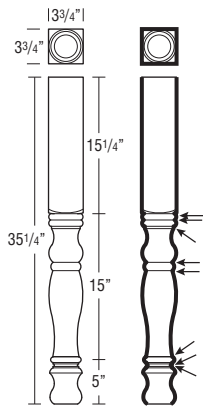

**ESTATE LEG, SMALL,  
2 3/4" WIDE,  
35 1/4" HIGH**



**JESTATELEGS**

- Trimmable.

**Finish Techniques**

Distressing	Heirloom
	•

**Species Availability (Wood)**

	Rustic Alder	Cherry	Rustic Hickory	Maple	Oak
•	Alder	•		•	•

**Species Availability (All Laminates)**

High Gloss box color	Horiz. Grain on Maple box color	Vert. Grain on Maple box color	Vert. Grain on Cherry box color	Vert. Grain on Oak box color
----------------------	---------------------------------	--------------------------------	---------------------------------	------------------------------

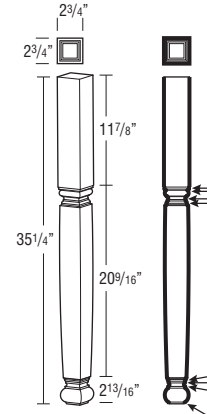

**ENGLISH BAR COLUMN,  
42 1/4" HIGH**



**ENGBARCOLUMN**

- Trimmable.

**Finish Techniques**

Distressing	Heirloom
	•

**Species Availability (Wood)**

	Rustic Alder	Cherry	Rustic Hickory	Maple	Oak
•	Alder	•		•	•

**Species Availability (All Laminates)**

High Gloss box color	Horiz. Grain on Maple box color	Vert. Grain on Maple box color	Vert. Grain on Cherry box color	Vert. Grain on Oak box color
----------------------	---------------------------------	--------------------------------	---------------------------------	------------------------------

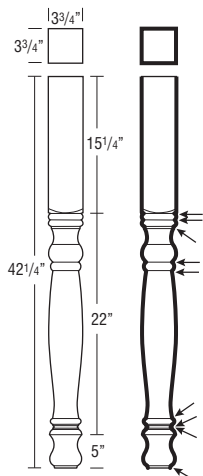

**ESTATE LEG SPLIT,  
SMALL, 2 3/4" WIDE,  
35 1/4" HIGH**



**JESTATELEGS**

- Trimmable.

**Finish Techniques**

Distressing	Heirloom
	•

**Species Availability (Wood)**

	Rustic Alder	Cherry	Rustic Hickory	Maple	Oak
•	Alder	•		•	•

**Species Availability (All Laminates)**

High Gloss box color	Horiz. Grain on Maple box color	Vert. Grain on Maple box color	Vert. Grain on Cherry box color	Vert. Grain on Oak box color
----------------------	---------------------------------	--------------------------------	---------------------------------	------------------------------

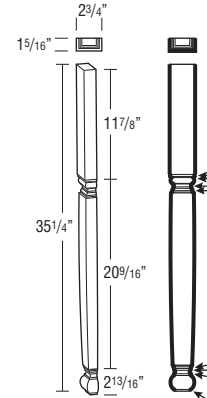

Finished edges indicated by bold lines on side view drawings.  
Glazed edges indicated by arrows on side view drawings.

DESCRIPTION

MODEL

ESTATE LEG, 35 1/4" HIGH

**JESTATELEG**  
• Trimmable.

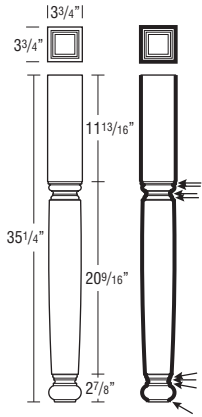

**Finish Techniques**

Distressing	Heirlooming
	•

**Species Availability (Wood)**

	Rustic Alder	Cherry	Rustic Hickory	Maple	Oak
•	Alder	•	•	•	•

**Species Availability (All Laminates)**

High Gloss box color	Horiz. Grain on Maple box color	Vert. Grain on Maple box color	Vert. Grain on Cherry box color	Vert. Grain on Oak box color
----------------------	---------------------------------	--------------------------------	---------------------------------	------------------------------

DESCRIPTION

MODEL

GAELIC LEG, 4 1/2" WIDE, 35 1/2" HIGH

**GAELICLEG**  
• Trimmable.

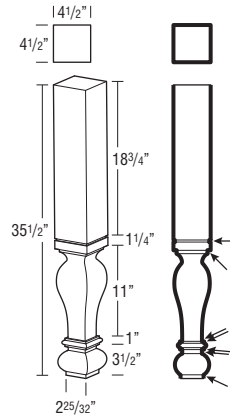

**Finish Techniques**

Distressing	Heirlooming
	•

**Species Availability (Wood)**

	Rustic Alder	Cherry	Rustic Hickory	Maple	Oak
•	Alder	•	•	•	•

**Species Availability (All Laminates)**

High Gloss box color	Horiz. Grain on Maple box color	Vert. Grain on Maple box color	Vert. Grain on Cherry box color	Vert. Grain on Oak box color
----------------------	---------------------------------	--------------------------------	---------------------------------	------------------------------

FRENCH COUNTRY LEG, 3 3/4" WIDE, 35 1/4" HIGH

**JFRNCNTYLEG**  
• Trimmable.

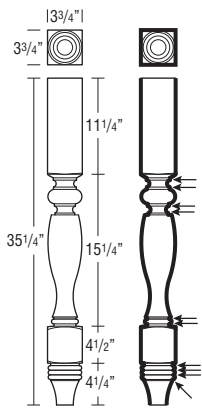

**Finish Techniques**

Distressing	Heirlooming
	•

**Species Availability (Wood)**

	Rustic Alder	Cherry	Rustic Hickory	Maple	Oak
•	Alder	•	•	•	•

**Species Availability (All Laminates)**

High Gloss box color	Horiz. Grain on Maple box color	Vert. Grain on Maple box color	Vert. Grain on Cherry box color	Vert. Grain on Oak box color
----------------------	---------------------------------	--------------------------------	---------------------------------	------------------------------

ISLAND LEG, 2-SIDED, 35 1/4" HIGH

**2SISLLEG**  
• Trimmable.

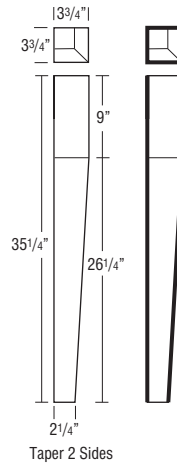

**Finish Techniques**

Distressing	Heirlooming
	•

**Species Availability (Wood)**

	Rustic Alder	Cherry	Rustic Hickory	Maple	Oak
•	Alder	•	•	•	•

**Species Availability (All Laminates)**

High Gloss box color	Horiz. Grain on Maple box color	Vert. Grain on Maple box color	Vert. Grain on Cherry box color	Vert. Grain on Oak box color
----------------------	---------------------------------	--------------------------------	---------------------------------	------------------------------

FRENCH COUNTRY LEG, 5" WIDE, 35 1/4" HIGH

**JFRNCNTYLEG**  
• Trimmable.

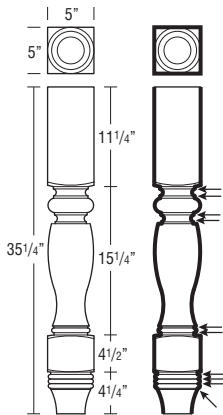

**Finish Techniques**

Distressing	Heirlooming
	•

**Species Availability (Wood)**

	Rustic Alder	Cherry	Rustic Hickory	Maple	Oak
•	Alder	•	•	•	•

**Species Availability (All Laminates)**

High Gloss box color	Horiz. Grain on Maple box color	Vert. Grain on Maple box color	Vert. Grain on Cherry box color	Vert. Grain on Oak box color
----------------------	---------------------------------	--------------------------------	---------------------------------	------------------------------

ISLAND LEG, 4-SIDED, 35 1/4" HIGH

**4SISLLEG**  
• Trimmable.

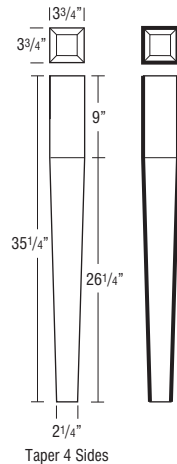

**Finish Techniques**

Distressing	Heirlooming
	•

**Species Availability (Wood)**

	Rustic Alder	Cherry	Rustic Hickory	Maple	Oak
•	Alder	•	•	•	•

**Species Availability (All Laminates)**

High Gloss box color	Horiz. Grain on Maple box color	Vert. Grain on Maple box color	Vert. Grain on Cherry box color	Vert. Grain on Oak box color
----------------------	---------------------------------	--------------------------------	---------------------------------	------------------------------

Finished edges indicated by bold lines on side view drawings.  
Glazed edges indicated by arrows on side view drawings.

**DESCRIPTION**

**MODEL**

**ISLAND LEG TAPERED,  
35 1/4" HIGH**



**ISLEGTPRD**

- Trimmable.

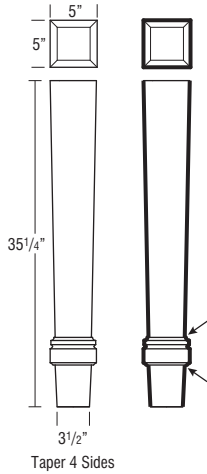

**Finish Techniques**

Distressing	Heirlooming
	•

**Species Availability (Wood)**

	Rustic Alder	Cherry	Rustic Hickory	Maple	Oak
•	•	•	•	•	•

**Species Availability (All Laminates)**

High Gloss box color	Horiz. Grain on Maple box color	Vert. Grain on Maple box color	Vert. Grain on Cherry box color	Vert. Grain on Oak box color
----------------------	---------------------------------	--------------------------------	---------------------------------	------------------------------

**DESCRIPTION**

**MODEL**

**MISSION LEG,  
34 1/2" HIGH**



**DLEGMSSION**

- Trimmable.

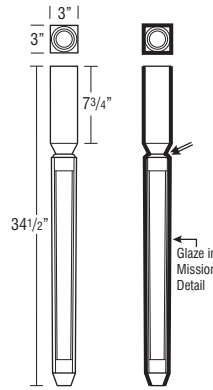

**Finish Techniques**

Distressing	Heirlooming
	•

**Species Availability (Wood)**

	Rustic Alder	Cherry	Rustic Hickory	Maple	Oak
•	•	•	•	•	•

**Species Availability (All Laminates)**

High Gloss box color	Horiz. Grain on Maple box color	Vert. Grain on Maple box color	Vert. Grain on Cherry box color	Vert. Grain on Oak box color
----------------------	---------------------------------	--------------------------------	---------------------------------	------------------------------

**METRO BAR COLUMN,  
42 1/4" HIGH**



**METBARCOLUMN**

- Trimmable.

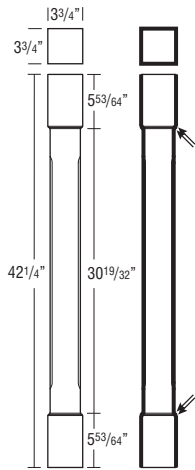

**Finish Techniques**

Distressing	Heirlooming
	•

**Species Availability (Wood)**

	Rustic Alder	Cherry	Rustic Hickory	Maple	Oak
•	•	•	•	•	•

**Species Availability (All Laminates)**

High Gloss box color	Horiz. Grain on Maple box color	Vert. Grain on Maple box color	Vert. Grain on Cherry box color	Vert. Grain on Oak box color
----------------------	---------------------------------	--------------------------------	---------------------------------	------------------------------

**SPOOL LEG SPLIT,  
SMALL, 2 3/4" WIDE,  
35 1/4" HIGH**



**JSPLGSS**

- Trimmable.

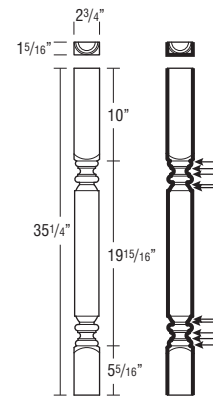

**Finish Techniques**

Distressing	Heirlooming
	•

**Species Availability (Wood)**

	Rustic Alder	Cherry	Rustic Hickory	Maple	Oak
•	•	•	•	•	•

**Species Availability (All Laminates)**

High Gloss box color	Horiz. Grain on Maple box color	Vert. Grain on Maple box color	Vert. Grain on Cherry box color	Vert. Grain on Oak box color
----------------------	---------------------------------	--------------------------------	---------------------------------	------------------------------

**METRO ISLAND COLUMN,  
34 5/8" HIGH**



**METISLCOLUMN**

- Trimmable.
- Leg is designed with three pieces joined together.

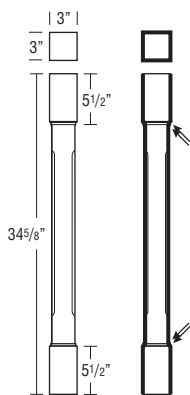

**Finish Techniques**

Distressing	Heirlooming
	•

**Species Availability (Wood)**

	Rustic Alder	Cherry	Rustic Hickory	Maple	Oak
•	•	•	•	•	•

**Species Availability (All Laminates)**

High Gloss box color	Horiz. Grain on Maple box color	Vert. Grain on Maple box color	Vert. Grain on Cherry box color	Vert. Grain on Oak box color
----------------------	---------------------------------	--------------------------------	---------------------------------	------------------------------

**SPOOL LEG,  
34 1/2" HIGH**



**SPLEG**

- Trimmable.

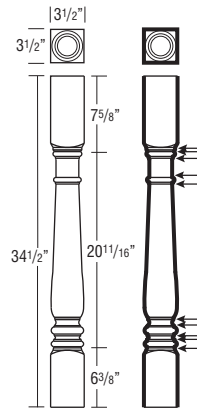

**Finish Techniques**

Distressing	Heirlooming
	•

**Species Availability (Wood)**

	Rustic Alder	Cherry	Rustic Hickory	Maple	Oak
•	•	•	•	•	•

**Species Availability (All Laminates)**

High Gloss box color	Horiz. Grain on Maple box color	Vert. Grain on Maple box color	Vert. Grain on Cherry box color	Vert. Grain on Oak box color
----------------------	---------------------------------	--------------------------------	---------------------------------	------------------------------

Finished edges indicated by bold lines on side view drawings.  
Glazed edges indicated by arrows on side view drawings.

DESCRIPTION

MODEL

**SQUARE ISLAND LEG,  
3" x 3", 35 1/4" HIGH**



**JSQISLEG3**

• Trimmable.



**Finish Techniques**

Distressing	Heirlooming
	•

**Species Availability (Wood)**

Alder	Rustic Alder	Cherry	Rustic Hickory	Maple	Oak
•	•	•	•	•	•

**Species Availability (All Laminates)**

High Gloss box color	Horiz. Grain on Maple box color	Vert. Grain on Maple box color	Vert. Grain on Cherry box color	Vert. Grain on Oak box color
----------------------	---------------------------------	--------------------------------	---------------------------------	------------------------------

DESCRIPTION

MODEL

**SQUARE ISLAND LEG,  
6" x 6", 35 1/4" HIGH**



**JSQISLEG6**

• Trimmable.

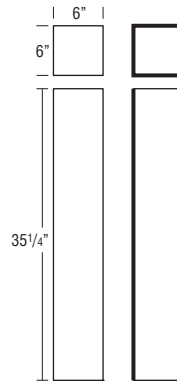

**Finish Techniques**

Distressing	Heirlooming
	•

**Species Availability (Wood)**

Alder	Rustic Alder	Cherry	Rustic Hickory	Maple	Oak
•	•	•	•	•	•

**Species Availability (All Laminates)**

High Gloss box color	Horiz. Grain on Maple box color	Vert. Grain on Maple box color	Vert. Grain on Cherry box color	Vert. Grain on Oak box color
----------------------	---------------------------------	--------------------------------	---------------------------------	------------------------------

**SQUARE ISLAND LEG,  
4" x 4", 35 1/4" HIGH**



**JSQISLEG4**

• Trimmable.

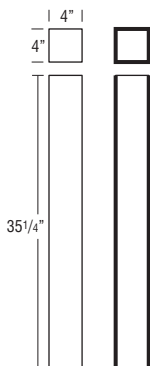

**Finish Techniques**

Distressing	Heirlooming
	•

**Species Availability (Wood)**

Alder	Rustic Alder	Cherry	Rustic Hickory	Maple	Oak
•	•	•	•	•	•

**Species Availability (All Laminates)**

High Gloss box color	Horiz. Grain on Maple box color	Vert. Grain on Maple box color	Vert. Grain on Cherry box color	Vert. Grain on Oak box color
----------------------	---------------------------------	--------------------------------	---------------------------------	------------------------------

**SQUARE BAR LEG,  
4" x 4", 42 1/4" HIGH**



**JSQBARLEG4**

• Trimmable.

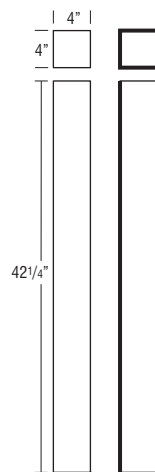

**Finish Techniques**

Distressing	Heirlooming
	•

**Species Availability (Wood)**

Alder	Rustic Alder	Cherry	Rustic Hickory	Maple	Oak
•	•	•	•	•	•

**Species Availability (All Laminates)**

High Gloss box color	Horiz. Grain on Maple box color	Vert. Grain on Maple box color	Vert. Grain on Cherry box color	Vert. Grain on Oak box color
----------------------	---------------------------------	--------------------------------	---------------------------------	------------------------------

**SQUARE ISLAND LEG,  
5" x 5", 35 1/4" HIGH**



**JSQISLEG5**

• Trimmable.

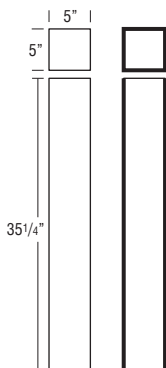

**Finish Techniques**

Distressing	Heirlooming
	•

**Species Availability (Wood)**

Alder	Rustic Alder	Cherry	Rustic Hickory	Maple	Oak
•	•	•	•	•	•

**Species Availability (All Laminates)**

High Gloss box color	Horiz. Grain on Maple box color	Vert. Grain on Maple box color	Vert. Grain on Cherry box color	Vert. Grain on Oak box color
----------------------	---------------------------------	--------------------------------	---------------------------------	------------------------------

**SQUARE BAR LEG,  
6" x 6", 42 1/4" HIGH**



**JSQBARLEG6**

• Trimmable.

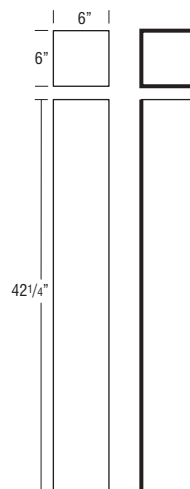

**Finish Techniques**

Distressing	Heirlooming
	•

**Species Availability (Wood)**

Alder	Rustic Alder	Cherry	Rustic Hickory	Maple	Oak
•	•	•	•	•	•

**Species Availability (All Laminates)**

High Gloss box color	Horiz. Grain on Maple box color	Vert. Grain on Maple box color	Vert. Grain on Cherry box color	Vert. Grain on Oak box color
----------------------	---------------------------------	--------------------------------	---------------------------------	------------------------------

Finished edges indicated by bold lines on side view drawings.  
Glazed edges indicated by arrows on side view drawings.

**DESCRIPTION**

**SQUARE ISLAND LEG, METAL SLEEVE, 3" x 3", 35 1/4" HIGH**

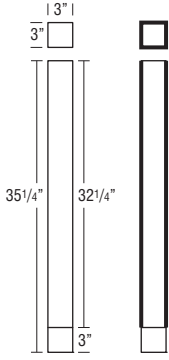

**MODEL**

**3SQLEGALS-35  
3SQLEGWIS-35**

- Trimmable from top of leg.
- Finishes available: Brushed Aluminum Sleeve (ALS) and Wrought Iron Sleeve (WIS).
- Constructed of three 1" solid-wood sections.

**Finish Techniques**

Distressing	Heirlooming
	•

**Species Availability (Wood)**

Rustic Alder	Rustic Alder	Cherry	Rustic Hickory	Maple	Oak
•	•	•	•	•	•

**Species Availability (All Laminates)**

High Gloss box color	Horiz. Grain on Maple box color	Vert. Grain on Maple box color	Vert. Grain on Cherry box color	Vert. Grain on Oak box color
----------------------	---------------------------------	--------------------------------	---------------------------------	------------------------------

**DESCRIPTION**

**SQUARE LEG with TAPERED FOOT, 3" WIDE, 35 1/4" HIGH**

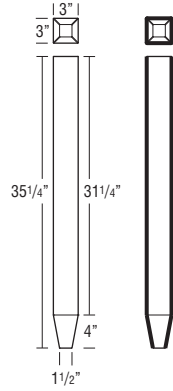

**MODEL**

**SQLEGTAP3**

- Trimmable.

**Finish Techniques**

Distressing	Heirlooming
	•

**Species Availability (Wood)**

Rustic Alder	Rustic Alder	Cherry	Rustic Hickory	Maple	Oak
•	•	•	•	•	•

**Species Availability (All Laminates)**

High Gloss box color	Horiz. Grain on Maple box color	Vert. Grain on Maple box color	Vert. Grain on Cherry box color	Vert. Grain on Oak box color
----------------------	---------------------------------	--------------------------------	---------------------------------	------------------------------

**SQUARE ISLAND LEG, METAL SLEEVE, 4" x 4", 35 1/4" HIGH**

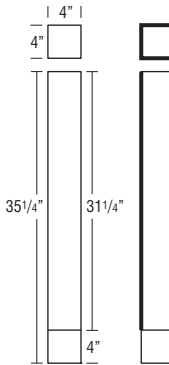

**4SQLEGALS-35  
4SQLEGWIS-35**

- Trimmable from top of leg.
- Finishes available: Brushed Aluminum Sleeve (ALS) and Wrought Iron Sleeve (WIS).
- Constructed of four 1" solid-wood sections.

**Finish Techniques**

Distressing	Heirlooming
	•

**Species Availability (Wood)**

Rustic Alder	Rustic Alder	Cherry	Rustic Hickory	Maple	Oak
•	•	•	•	•	•

**Species Availability (All Laminates)**

High Gloss box color	Horiz. Grain on Maple box color	Vert. Grain on Maple box color	Vert. Grain on Cherry box color	Vert. Grain on Oak box color
----------------------	---------------------------------	--------------------------------	---------------------------------	------------------------------

**SQUARE LEG with TAPERED FOOT, 4" WIDE, 35 1/4" HIGH**

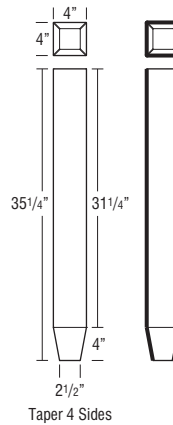

**SQLEGTAP4**

- Trimmable.

**Finish Techniques**

Distressing	Heirlooming
	•

**Species Availability (Wood)**

Rustic Alder	Rustic Alder	Cherry	Rustic Hickory	Maple	Oak
•	•	•	•	•	•

**Species Availability (All Laminates)**

High Gloss box color	Horiz. Grain on Maple box color	Vert. Grain on Maple box color	Vert. Grain on Cherry box color	Vert. Grain on Oak box color
----------------------	---------------------------------	--------------------------------	---------------------------------	------------------------------

**SQUARE ISLAND LEG, METAL SLEEVE, 5" x 5", 35 1/4" HIGH**

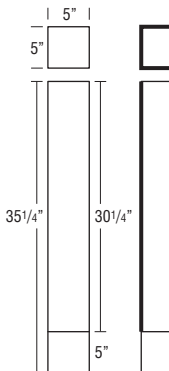

**5SQLEGALS-35  
5SQLEGWIS-35**

- Trimmable from top of leg.
- Finishes available: Brushed Aluminum Sleeve (ALS) and Wrought Iron Sleeve (WIS).
- Constructed of five 1" solid-wood sections.

**Finish Techniques**

Distressing	Heirlooming
	•

**Species Availability (Wood)**

Rustic Alder	Rustic Alder	Cherry	Rustic Hickory	Maple	Oak
•	•	•	•	•	•

**Species Availability (All Laminates)**

High Gloss box color	Horiz. Grain on Maple box color	Vert. Grain on Maple box color	Vert. Grain on Cherry box color	Vert. Grain on Oak box color
----------------------	---------------------------------	--------------------------------	---------------------------------	------------------------------

**TURNUED POST ISLAND LEG, 35 1/4" HIGH**

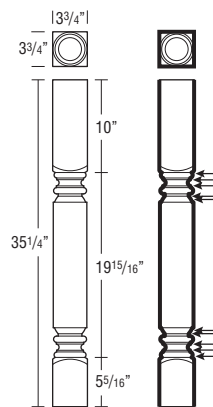

**TURNUEDPOST**

- Trimmable.

**Finish Techniques**

Distressing	Heirlooming
	•

**Species Availability (Wood)**

Rustic Alder	Rustic Alder	Cherry	Rustic Hickory	Maple	Oak
•	•	•	•	•	•

**Species Availability (All Laminates)**

High Gloss box color	Horiz. Grain on Maple box color	Vert. Grain on Maple box color	Vert. Grain on Cherry box color	Vert. Grain on Oak box color
----------------------	---------------------------------	--------------------------------	---------------------------------	------------------------------

Finished edges indicated by bold lines on side view drawings.  
Glazed edges indicated by arrows on side view drawings.

DESCRIPTION

MODEL

URN LEG, 35 1/4" HIGH

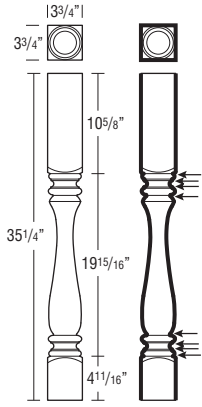

**Finish Techniques**

Distressing	Heirlooming
	•

**Species Availability (Wood)**

	Rustic Alder	Cherry	Rustic Hickory	Maple	Oak
•		•		•	•

**Species Availability (All Laminates)**

High Gloss box color	Horiz. Grain on Maple box color	Vert. Grain on Maple box color	Vert. Grain on Cherry box color	Vert. Grain on Oak box color
----------------------	---------------------------------	--------------------------------	---------------------------------	------------------------------

URN LEG, 5" WIDE, 35 1/4" HIGH

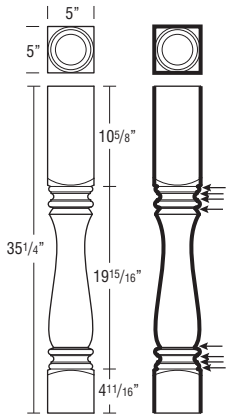

**Finish Techniques**

Distressing	Heirlooming
	•

**Species Availability (Wood)**

	Rustic Alder	Cherry	Rustic Hickory	Maple	Oak
•		•		•	•

**Species Availability (All Laminates)**

High Gloss box color	Horiz. Grain on Maple box color	Vert. Grain on Maple box color	Vert. Grain on Cherry box color	Vert. Grain on Oak box color
----------------------	---------------------------------	--------------------------------	---------------------------------	------------------------------

ABBE FOOT, 4" HIGH

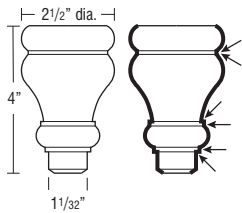

**Finish Techniques**

Distressing	Heirlooming
	•

**Species Availability (Wood)**

	Rustic Alder	Cherry	Rustic Hickory	Maple	Oak
•		•		•	•

**Species Availability (All Laminates)**

High Gloss box color	Horiz. Grain on Maple box color	Vert. Grain on Maple box color	Vert. Grain on Cherry box color	Vert. Grain on Oak box color
----------------------	---------------------------------	--------------------------------	---------------------------------	------------------------------

DESCRIPTION

MODEL

COSMO FOOT, 4" HIGH

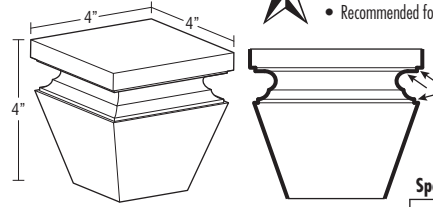

**Finish Techniques**

Distressing	Heirlooming
	•

**Species Availability (Wood)**

	Rustic Alder	Cherry	Rustic Hickory	Maple	Oak
•		•		•	•

**Species Availability (All Laminates)**

High Gloss box color	Horiz. Grain on Maple box color	Vert. Grain on Maple box color	Vert. Grain on Cherry box color	Vert. Grain on Oak box color
----------------------	---------------------------------	--------------------------------	---------------------------------	------------------------------

CRAFTSMAN FOOT, 4 1/2" HIGH

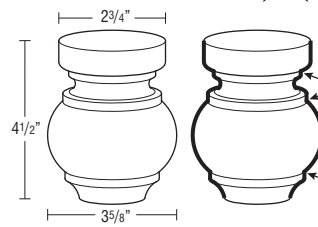

**Finish Techniques**

Distressing	Heirlooming
	•

**Species Availability (Wood)**

	Rustic Alder	Cherry	Rustic Hickory	Maple	Oak
•		•		•	•

**Species Availability (All Laminates)**

High Gloss box color	Horiz. Grain on Maple box color	Vert. Grain on Maple box color	Vert. Grain on Cherry box color	Vert. Grain on Oak box color
----------------------	---------------------------------	--------------------------------	---------------------------------	------------------------------

KENSINGTON BUN FOOT, 4 1/2" HIGH

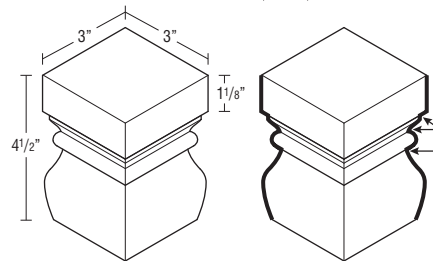

**Finish Techniques**

Distressing	Heirlooming
	•

**Species Availability (Wood)**

	Rustic Alder	Cherry	Rustic Hickory	Maple	Oak
•		•		•	•

**Species Availability (All Laminates)**

High Gloss box color	Horiz. Grain on Maple box color	Vert. Grain on Maple box color	Vert. Grain on Cherry box color	Vert. Grain on Oak box color
----------------------	---------------------------------	--------------------------------	---------------------------------	------------------------------

Finished edges indicated by bold lines on side view drawings.  
Glazed edges indicated by arrows on side view drawings.

**DESCRIPTION**

**MODEL**

**MADLINE FOOT, 4 1/2" HIGH**



**JMADEFOOT**

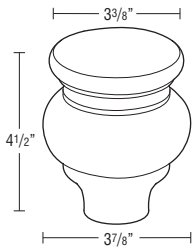

**Finish Techniques**

Distressing	Heirloom
	•

**Species Availability (Wood)**

	Rustic Alder	Cherry	Rustic Hickory	Maple	Oak
•	Alder	•		•	•

**Species Availability (All Laminates)**

High Gloss box color	Horiz. Grain on Maple box color	Vert. Grain on Maple box color	Vert. Grain on Cherry box color	Vert. Grain on Oak box color
----------------------	---------------------------------	--------------------------------	---------------------------------	------------------------------

**METROPOLITAN FOOT, 4 5/8" HIGH**



**JMETROFOOT**

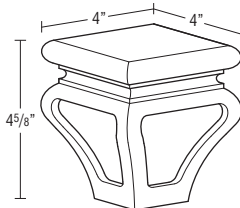

**Finish Techniques**

Distressing	Heirloom
	•

**Species Availability (Wood)**

	Rustic Alder	Cherry	Rustic Hickory	Maple	Oak
•	Alder	•		•	•

**Species Availability (All Laminates)**

High Gloss box color	Horiz. Grain on Maple box color	Vert. Grain on Maple box color	Vert. Grain on Cherry box color	Vert. Grain on Oak box color
----------------------	---------------------------------	--------------------------------	---------------------------------	------------------------------

**LARGE SQUARE FOOT, 5" HIGH**



**LGSQFOOT**

- Trimable.

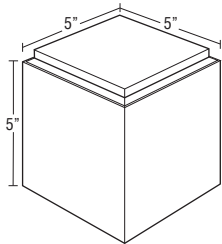

**Finish Techniques**

Distressing	Heirloom
	•

**Species Availability (Wood)**

	Rustic Alder	Cherry	Rustic Hickory	Maple	Oak
•	Alder	•		•	•

**Species Availability (All Laminates)**

High Gloss box color	Horiz. Grain on Maple box color	Vert. Grain on Maple box color	Vert. Grain on Cherry box color	Vert. Grain on Oak box color
----------------------	---------------------------------	--------------------------------	---------------------------------	------------------------------

**DESCRIPTION**

**MODEL**

**SQUARE FOOT, 4 1/2" HIGH**



**JSQFOOT**

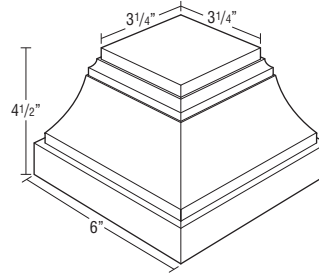

**Finish Techniques**

Distressing	Heirloom
	•

**Species Availability (Wood)**

	Rustic Alder	Cherry	Rustic Hickory	Maple	Oak
•	Alder	•		•	•

**Species Availability (All Laminates)**

High Gloss box color	Horiz. Grain on Maple box color	Vert. Grain on Maple box color	Vert. Grain on Cherry box color	Vert. Grain on Oak box color
----------------------	---------------------------------	--------------------------------	---------------------------------	------------------------------

**SQUARE FOOT, SPLIT, 4 1/2" HIGH**



**JSQFOOTS**

- Trimable.

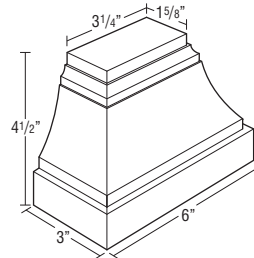

**Finish Techniques**

Distressing	Heirloom
	•

**Species Availability (Wood)**

	Rustic Alder	Cherry	Rustic Hickory	Maple	Oak
•	Alder	•		•	•

**Species Availability (All Laminates)**

High Gloss box color	Horiz. Grain on Maple box color	Vert. Grain on Maple box color	Vert. Grain on Cherry box color	Vert. Grain on Oak box color
----------------------	---------------------------------	--------------------------------	---------------------------------	------------------------------

**LILLE FOOT, 4 1/2" HIGH**



**LIFOOT**

- Recommended for applications without toekicks.

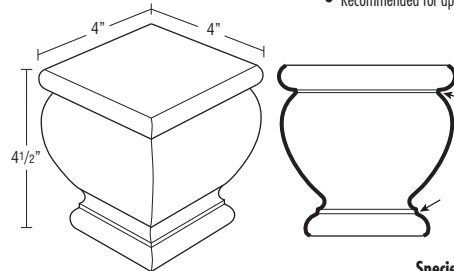

**Finish Techniques**

Distressing	Heirloom
	•

**Species Availability (Wood)**

	Rustic Alder	Cherry	Rustic Hickory	Maple	Oak
•	Alder	•		•	•

**Species Availability (All Laminates)**

High Gloss box color	Horiz. Grain on Maple box color	Vert. Grain on Maple box color	Vert. Grain on Cherry box color	Vert. Grain on Oak box color
----------------------	---------------------------------	--------------------------------	---------------------------------	------------------------------

Finished edges indicated by bold lines on side view drawings.  
Glazed edges indicated by arrows on side view drawings.

DESCRIPTION

MODEL

PLINTH BLOCK,  
4 1/2" HIGH



PLBLOCK

- Trimmable.

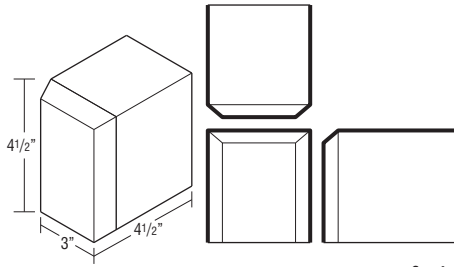

**Finish Techniques**

Distressing	Heirlooming
	•

**Species Availability (Wood)**

	Rustic Alder	Cherry	Rustic Hickory	Maple	Oak
•	Alder	•	Hickory	•	•

**Species Availability (All Laminates)**

High Gloss box color	Horiz. Grain on Maple box color	Vert. Grain on Maple box color	Vert. Grain on Cherry box color	Vert. Grain on Oak box color
----------------------	---------------------------------	--------------------------------	---------------------------------	------------------------------

TAPERED LEG, 6" HIGH



TAPLG

- Trimmable.

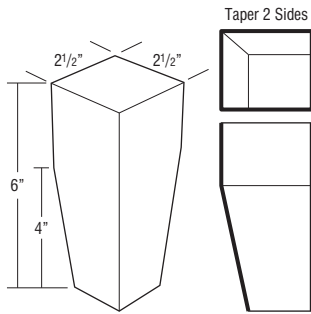

**Finish Techniques**

Distressing	Heirlooming
	•

**Species Availability (Wood)**

	Rustic Alder	Cherry	Rustic Hickory	Maple	Oak
•	Alder	•	Hickory	•	•

**Species Availability (All Laminates)**

High Gloss box color	Horiz. Grain on Maple box color	Vert. Grain on Maple box color	Vert. Grain on Cherry box color	Vert. Grain on Oak box color
----------------------	---------------------------------	--------------------------------	---------------------------------	------------------------------

DESCRIPTION

MODEL

TOEKICK TULIP FOOT,  
4 5/8" HIGH



TKTLFOOT

- Trimmable.

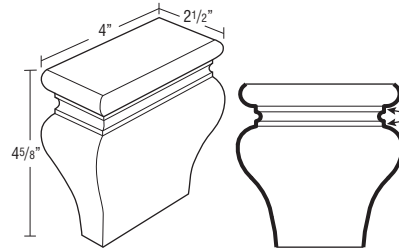

**Finish Techniques**

Distressing	Heirlooming
	•

**Species Availability (Wood)**

	Rustic Alder	Cherry	Rustic Hickory	Maple	Oak
•	Alder	•	Hickory	•	•

**Species Availability (All Laminates)**

High Gloss box color	Horiz. Grain on Maple box color	Vert. Grain on Maple box color	Vert. Grain on Cherry box color	Vert. Grain on Oak box color
----------------------	---------------------------------	--------------------------------	---------------------------------	------------------------------

TULIP FOOT, 4 5/8" HIGH



TLFOOT

- Trimmable.

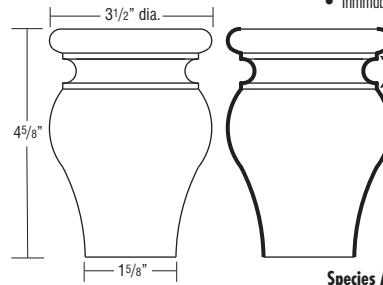

**Finish Techniques**

Distressing	Heirlooming
	•

**Species Availability (Wood)**

	Rustic Alder	Cherry	Rustic Hickory	Maple	Oak
•	Alder	•	Hickory	•	•

**Species Availability (All Laminates)**

High Gloss box color	Horiz. Grain on Maple box color	Vert. Grain on Maple box color	Vert. Grain on Cherry box color	Vert. Grain on Oak box color
----------------------	---------------------------------	--------------------------------	---------------------------------	------------------------------

2" DECORATIVE  
SPLIT TURNINGS

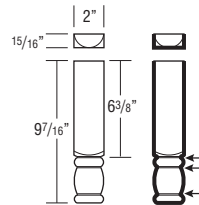

SPRINGEND

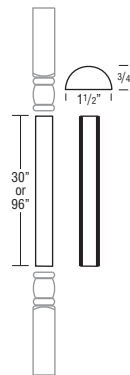

SPRINGSPOOL\_\_

SPRINGEND (Sold in Pairs)

SPRINGSPOOL30 (Half Round)

SPRINGSPOOL96 (Half Round)

- Ends sold separately from split turnings.
- 5 day Express Response not available on Architectural Accents.

**Finish Techniques**

Distressing	Heirlooming
	•

**Species Availability (Wood)**

	Rustic Alder	Cherry	Rustic Hickory	Maple	Oak
•	Alder	•	Hickory	•	•

**Species Availability (All Laminates)**

High Gloss box color	Horiz. Grain on Maple box color	Vert. Grain on Maple box color	Vert. Grain on Cherry box color	Vert. Grain on Oak box color
----------------------	---------------------------------	--------------------------------	---------------------------------	------------------------------

Finished edges indicated by bold lines on side view drawings.  
Glazed edges indicated by arrows on side view drawings.



**DESCRIPTION**

**9" SMALL CORBEL**

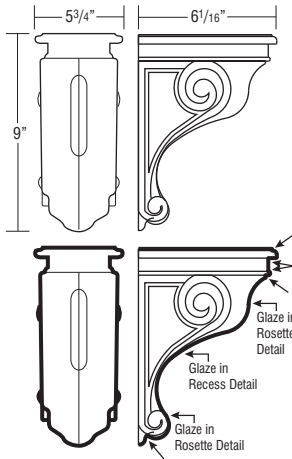

**MODEL**

**SMCORBEL**

- Not intended for cabinet or freestanding countertop support. For substantial weight support, use a floor mounted support such as a Decorative Leg.

**Finish Techniques**

Distressing	Heirlooming
	•

**Species Availability (Wood)**

Rustic Alder	Rustic Alder	Cherry	Rustic Hickory	Maple	Oak
•	•			•	•

**Species Availability (All Laminates)**

High Gloss box color	Horiz. Grain on Maple box color	Vert. Grain on Maple box color	Vert. Grain on Cherry box color	Vert. Grain on Oak box color
----------------------	---------------------------------	--------------------------------	---------------------------------	------------------------------

**DESCRIPTION**

**9" CLASSIC REVIVAL CORBEL**

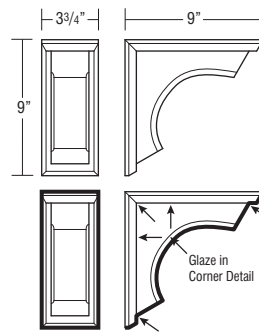

**MODEL**

**CORBELCR9**

- Not intended for cabinet or freestanding countertop support. For substantial weight support, use a floor mounted support such as a Decorative Leg.

**Finish Techniques**

Distressing	Heirlooming
	•

**Species Availability (Wood)**

Rustic Alder	Rustic Alder	Cherry	Rustic Hickory	Maple	Oak
•	•			•	•

**Species Availability (All Laminates)**

High Gloss box color	Horiz. Grain on Maple box color	Vert. Grain on Maple box color	Vert. Grain on Cherry box color	Vert. Grain on Oak box color
----------------------	---------------------------------	--------------------------------	---------------------------------	------------------------------

**13" LARGE CORBEL**

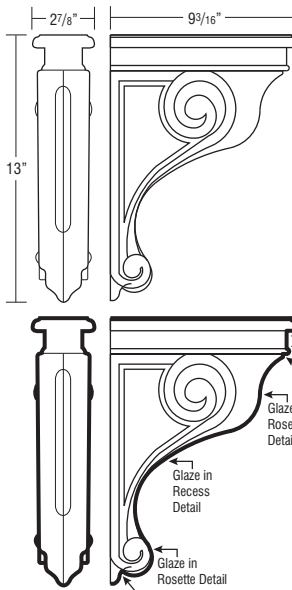

**MODEL**

**LGCORBEL**

- Not intended for cabinet or freestanding countertop support. For substantial weight support, use a floor mounted support such as a Decorative Leg.

**Finish Techniques**

Distressing	Heirlooming
	•

**Species Availability (Wood)**

Rustic Alder	Rustic Alder	Cherry	Rustic Hickory	Maple	Oak
•	•			•	•

**Species Availability (All Laminates)**

High Gloss box color	Horiz. Grain on Maple box color	Vert. Grain on Maple box color	Vert. Grain on Cherry box color	Vert. Grain on Oak box color
----------------------	---------------------------------	--------------------------------	---------------------------------	------------------------------

**13" LARGE COSMO CORBEL DEEP**

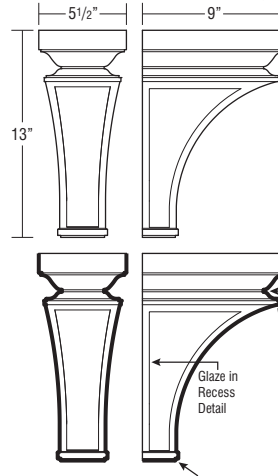

**MODEL**

**JCORBELCOS13D**

- Not intended for cabinet or freestanding countertop support. For substantial weight support, use a floor mounted support such as a Decorative Leg.

**Finish Techniques**

Distressing	Heirlooming
	•

**Species Availability (Wood)**

Rustic Alder	Rustic Alder	Cherry	Rustic Hickory	Maple	Oak
•	•			•	•

**Species Availability (All Laminates)**

High Gloss box color	Horiz. Grain on Maple box color	Vert. Grain on Maple box color	Vert. Grain on Cherry box color	Vert. Grain on Oak box color
----------------------	---------------------------------	--------------------------------	---------------------------------	------------------------------

**9" ART CORBEL**

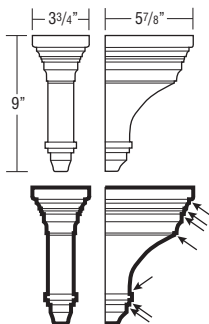

**MODEL**

**CORBELART9**

- Not intended for cabinet or freestanding countertop support. For substantial weight support, use a floor mounted support such as a Decorative Leg.

**Finish Techniques**

Distressing	Heirlooming
	•

**Species Availability (Wood)**

Rustic Alder	Rustic Alder	Cherry	Rustic Hickory	Maple	Oak
•	•			•	•

**Species Availability (All Laminates)**

High Gloss box color	Horiz. Grain on Maple box color	Vert. Grain on Maple box color	Vert. Grain on Cherry box color	Vert. Grain on Oak box color
----------------------	---------------------------------	--------------------------------	---------------------------------	------------------------------

**7" COVE CORBEL**

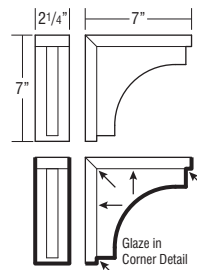

**MODEL**

**CORBELCOVE7**

- Not intended for cabinet or freestanding countertop support. For substantial weight support, use a floor mounted support such as a Decorative Leg.

**Finish Techniques**

Distressing	Heirlooming
	•

**Species Availability (Wood)**

Rustic Alder	Rustic Alder	Cherry	Rustic Hickory	Maple	Oak
•	•		•	•	•

**Species Availability (All Laminates)**

High Gloss box color	Horiz. Grain on Maple box color	Vert. Grain on Maple box color	Vert. Grain on Cherry box color	Vert. Grain on Oak box color
----------------------	---------------------------------	--------------------------------	---------------------------------	------------------------------

Finished edges indicated by bold lines on side view drawings.  
Glazed edges indicated by arrows on side view drawings.

DESCRIPTION

MODEL

11 1/4" COVE CORBEL



CORBELCOVE11

- Not intended for cabinet or freestanding countertop support. For substantial weight support, use a floor mounted support such as a Decorative Leg.

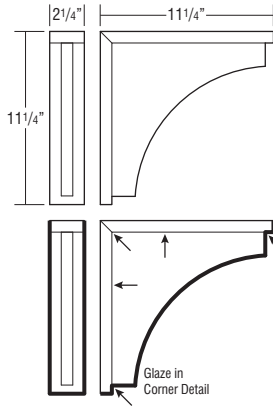

Finish Techniques

Distressing	Heirloom
	•

Species Availability (Wood)

Alder	Rustic Alder	Cherry	Rustic Hickory	Maple	Oak
•	•	•	•	•	•

Species Availability (All Laminates)

High Gloss	Horiz. Grain on Maple	Vert. Grain on Maple	Vert. Grain on Cherry	Vert. Grain on Oak
box color	box color	box color	box color	box color

DESCRIPTION

MODEL

11 1/4" SNACK BAR SUPPORT



SBS

- Not intended for cabinet or freestanding countertop support. For substantial weight support, use a floor mounted support such as a Decorative Leg.

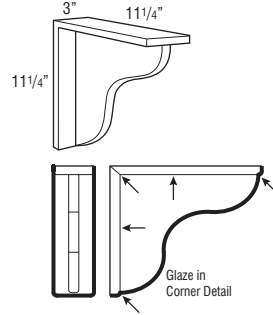

Finish Techniques

Distressing	Heirloom
	•

Species Availability (Wood)

Alder	Rustic Alder	Cherry	Rustic Hickory	Maple	Oak
•	•	•	•	•	•

Species Availability (All Laminates)

High Gloss	Horiz. Grain on Maple	Vert. Grain on Maple	Vert. Grain on Cherry	Vert. Grain on Oak
box color	box color	box color	box color	box color

6" MISSION CORBEL



CORBELMIS6

- Not intended for cabinet or freestanding countertop support. For substantial weight support, use a floor mounted support such as a Decorative Leg.

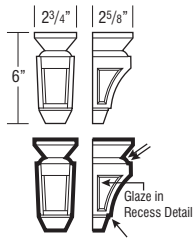

Finish Techniques

Distressing	Heirloom
	•

Species Availability (Wood)

Alder	Rustic Alder	Cherry	Rustic Hickory	Maple	Oak
•	•	•	•	•	•

Species Availability (All Laminates)

High Gloss	Horiz. Grain on Maple	Vert. Grain on Maple	Vert. Grain on Cherry	Vert. Grain on Oak
box color	box color	box color	box color	box color

11 1/2" ARTS & CRAFTS BRACKET



JBRACKETART

- Not intended for cabinet or freestanding countertop support. For substantial weight support, use a floor mounted support such as a Decorative Leg.

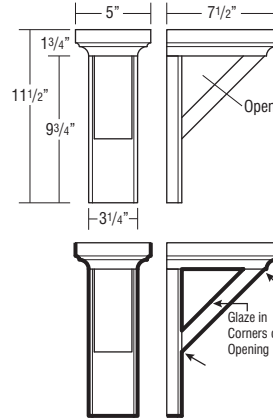

Finish Techniques

Distressing	Heirloom
	•

Species Availability (Wood)

Alder	Rustic Alder	Cherry	Rustic Hickory	Maple	Oak
•	•	•	•	•	•

Species Availability (All Laminates)

High Gloss	Horiz. Grain on Maple	Vert. Grain on Maple	Vert. Grain on Cherry	Vert. Grain on Oak
box color	box color	box color	box color	box color

9" MISSION CORBEL



CORBELMIS9

- Not intended for cabinet or freestanding countertop support. For substantial weight support, use a floor mounted support such as a Decorative Leg.

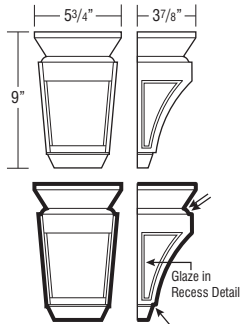

Finish Techniques

Distressing	Heirloom
	•

Species Availability (Wood)

Alder	Rustic Alder	Cherry	Rustic Hickory	Maple	Oak
•	•	•	•	•	•

Species Availability (All Laminates)

High Gloss	Horiz. Grain on Maple	Vert. Grain on Maple	Vert. Grain on Cherry	Vert. Grain on Oak
box color	box color	box color	box color	box color

12" CRAFTSMAN OPEN BRACKET



JCORBELCRAFTO

- Not intended for cabinet or freestanding countertop support. For substantial weight support, use a floor mounted support such as a Decorative Leg.

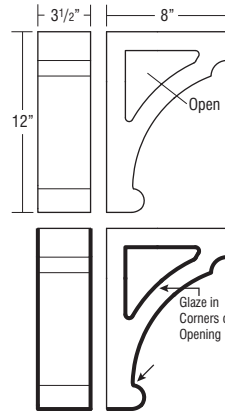

Finish Techniques

Distressing	Heirloom
	•

Species Availability (Wood)

Alder	Rustic Alder	Cherry	Rustic Hickory	Maple	Oak
•	•	•	•	•	•

Species Availability (All Laminates)

High Gloss	Horiz. Grain on Maple	Vert. Grain on Maple	Vert. Grain on Cherry	Vert. Grain on Oak
box color	box color	box color	box color	box color

5" OLD WORLD CORBEL



CORBELOWD5

- Not intended for cabinet or freestanding countertop support. For substantial weight support, use a floor mounted support such as a Decorative Leg.

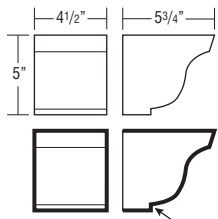

Finish Techniques

Distressing	Heirloom
	•

Species Availability (Wood)

Alder	Rustic Alder	Cherry	Rustic Hickory	Maple	Oak
•	•	•	•	•	•

Species Availability (All Laminates)

High Gloss	Horiz. Grain on Maple	Vert. Grain on Maple	Vert. Grain on Cherry	Vert. Grain on Oak
box color	box color	box color	box color	box color

Finished edges indicated by bold lines on side view drawings.  
Glazed edges indicated by arrows on side view drawings.

**DESCRIPTION**

**MODEL**

**6 1/2" SMALL SHAKER CORBEL**



**JCORBELSHKR7**

- Not intended for cabinet or freestanding countertop support. For substantial weight support, use a floor mounted support such as a Decorative Leg.

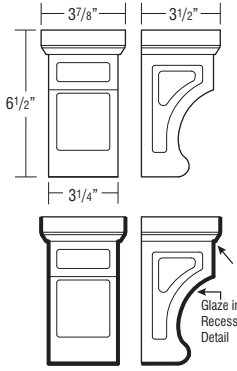

**Finish Techniques**

Distressing	Heirlooming
	•

**Species Availability (Wood)**

Rustic Alder	Rustic Alder	Cherry	Rustic Hickory	Maple	Oak
•	Alder	•		•	•

**Species Availability (All Laminates)**

High Gloss box color	Horiz. Grain on Maple box color	Vert. Grain on Maple box color	Vert. Grain on Cherry box color	Vert. Grain on Oak box color
----------------------	---------------------------------	--------------------------------	---------------------------------	------------------------------

**DESCRIPTION**

**MODEL**

**9" TRIAD CORBEL, NARROW**



**CORBELTRIAD9N**

- Not intended for cabinet or freestanding countertop support. For substantial weight support, use a floor mounted support such as a Decorative Leg.

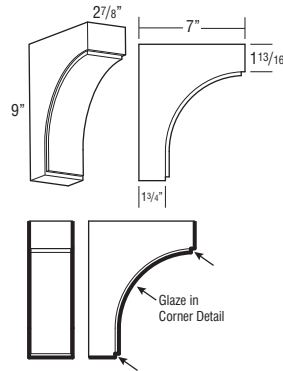

**Finish Techniques**

Distressing	Heirlooming
	•

**Species Availability (Wood)**

Rustic Alder	Rustic Alder	Cherry	Rustic Hickory	Maple	Oak
•	Alder	•		•	•

**Species Availability (All Laminates)**

High Gloss box color	Horiz. Grain on Maple box color	Vert. Grain on Maple box color	Vert. Grain on Cherry box color	Vert. Grain on Oak box color
----------------------	---------------------------------	--------------------------------	---------------------------------	------------------------------

**13 3/8" MEDIUM SHAKER CORBEL**



**JCORBELSHKR14**

- Not intended for cabinet or freestanding countertop support. For substantial weight support, use a floor mounted support such as a Decorative Leg.

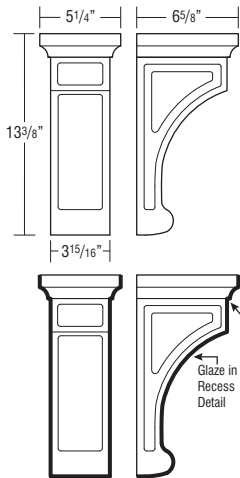

**Finish Techniques**

Distressing	Heirlooming
	•

**Species Availability (Wood)**

Rustic Alder	Rustic Alder	Cherry	Rustic Hickory	Maple	Oak
•	Alder	•		•	•

**Species Availability (All Laminates)**

High Gloss box color	Horiz. Grain on Maple box color	Vert. Grain on Maple box color	Vert. Grain on Cherry box color	Vert. Grain on Oak box color
----------------------	---------------------------------	--------------------------------	---------------------------------	------------------------------

**12" TRIAD CORBEL**



**CORBELTRIAD12**

- Not intended for cabinet or freestanding countertop support. For substantial weight support, use a floor mounted support such as a Decorative Leg.

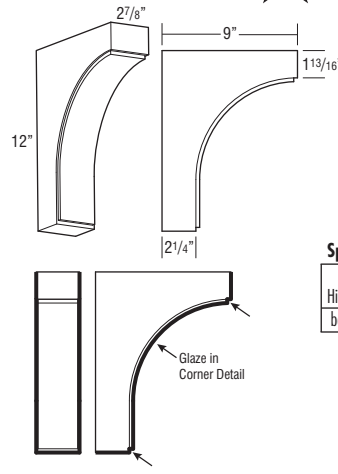

**Finish Techniques**

Distressing	Heirlooming
	•

**Species Availability (Wood)**

Rustic Alder	Rustic Alder	Cherry	Rustic Hickory	Maple	Oak
•	Alder	•		•	•

**Species Availability (All Laminates)**

High Gloss box color	Horiz. Grain on Maple box color	Vert. Grain on Maple box color	Vert. Grain on Cherry box color	Vert. Grain on Oak box color
----------------------	---------------------------------	--------------------------------	---------------------------------	------------------------------

**5 1/2" TRIAD CORBEL**



**CORBELTRIAD6**

- Not intended for cabinet or freestanding countertop support. For substantial weight support, use a floor mounted support such as a Decorative Leg.

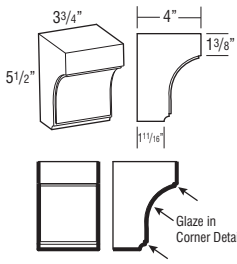

**Finish Techniques**

Distressing	Heirlooming
	•

**Species Availability (Wood)**

Rustic Alder	Rustic Alder	Cherry	Rustic Hickory	Maple	Oak
•	Alder	•		•	•

**Species Availability (All Laminates)**

High Gloss box color	Horiz. Grain on Maple box color	Vert. Grain on Maple box color	Vert. Grain on Cherry box color	Vert. Grain on Oak box color
----------------------	---------------------------------	--------------------------------	---------------------------------	------------------------------

**9" BAUHAUS CORBEL**



**CORBELBAU9 CORBELBAUW19**

- Finishes available: Brushed Aluminum (AL) and Wrought Iron (WI).
- Not intended for cabinet or freestanding countertop support. For substantial weight support, use a floor mounted support such as a Decorative Leg.

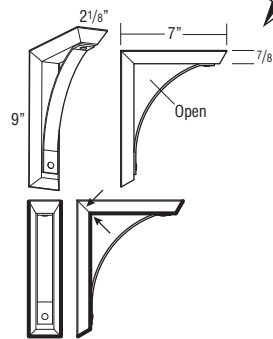

**Finish Techniques**

Distressing	Heirlooming
	•

**Species Availability (Wood)**

Rustic Alder	Rustic Alder	Cherry	Rustic Hickory	Maple	Oak
•	Alder	•	Hickory	•	•

**Species Availability (All Laminates)**

High Gloss box color	Horiz. Grain on Maple box color	Vert. Grain on Maple box color	Vert. Grain on Cherry box color	Vert. Grain on Oak box color
----------------------	---------------------------------	--------------------------------	---------------------------------	------------------------------

Finished edges indicated by bold lines on side view drawings.  
Glazed edges indicated by arrows on side view drawings.

**DESCRIPTION**

**MODEL**

**12" BAUHAUS CORBEL**



**CORBELBAU12**  
**CORBELBAUW12**

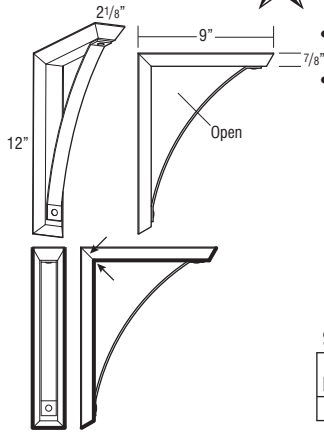

- Finishes available: Brushed Aluminum (AL) and Wrought Iron (WI).
- Not intended for cabinet or freestanding countertop support. For substantial weight support, use a floor mounted support such as a Decorative Leg.

**Finish Techniques**

Distressing	Heirlooming
	•

**Species Availability (Wood)**

	Rustic Alder	Cherry	Rustic Hickory	Maple	Oak
•	Alder	•	Hickory	•	•

**Species Availability (All Laminates)**

High Gloss	Horiz. Grain on Maple	Vert. Grain on Maple	Vert. Grain on Cherry	Vert. Grain on Oak
box color	box color	box color	box color	box color

**SINGLE OUTLET COVER**



**JSOC**

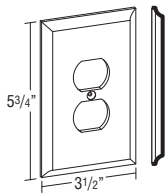

**Finish Techniques**

Distressing	Heirlooming
	•

**Species Availability (Wood)**

	Rustic Alder	Cherry	Rustic Hickory	Maple	Oak
•	Alder	•	Hickory	•	•

**Species Availability (All Laminates)**

High Gloss	Horiz. Grain on Maple	Vert. Grain on Maple	Vert. Grain on Cherry	Vert. Grain on Oak
box color	box color	box color	box color	box color

**SINGLE ROCKER PLATE**



**JSRC**

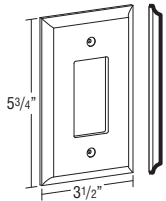

**Finish Techniques**

Distressing	Heirlooming
	•

**Species Availability (Wood)**

	Rustic Alder	Cherry	Rustic Hickory	Maple	Oak
•	Alder	•	Hickory	•	•

**Species Availability (All Laminates)**

High Gloss	Horiz. Grain on Maple	Vert. Grain on Maple	Vert. Grain on Cherry	Vert. Grain on Oak
box color	box color	box color	box color	box color

Finished edges indicated by bold lines on side view drawings.  
Glazed edges indicated by arrows on side view drawings.

**DESCRIPTION**

**MODEL**

**CONTEMPORARY EMBELLISHMENTS**

**METAL FEET, SQUARE**

**FOOTMETALSQBS**

**FOOTMETALSQPS**

- BS = Brushed Stainless
- PS = Polished Stainless

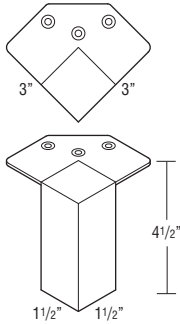

**TOUCH LATCH**

**TOUHLATCH**

- Nylon gray mechanism with bumper tip.
- Face frame will need to be field drilled for insertion of the TOUCHLATCH, requires 25/64" (10mm) drill bit.
- Can be field adjusted for door gap depth, no tools required.
- For use on full overlay door styles only.
- Requires a soft touch to open the door, and door must be pushed closed to reset the TOUCHLATCH mechanism.
- Only for use on hinged doors, and can be used without decorative hardware. Not compatible with non-hinged doors such as pull-outs, Wall Vertical-lift (WVL...). For drawers, pull-outs, and other non-compatible cabinets, PULLH105, PULLH106, and PULLH107 are recommended (see page 367).

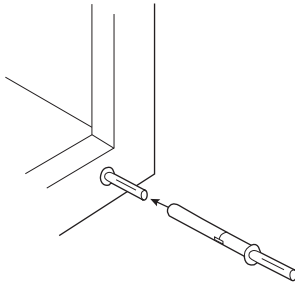

**DESCRIPTION**

**MODEL**

**MID-CENTURY TRIANGLE BRACKET, 12 3/4" DEEP**

**TRIBRKT12GMG**

**TRIBRKT12WI**

**TRIBRKT12SS**

- Finishes available: Gun Metal Gray (GMG), Wrought Iron (WI), and Stainless Steel (SS).
- Includes matching hardware.
- Pre-drilled mounting holes for easy installation.
- Designed for a 12" deep, 3/4" thick shelf to be placed inside bracket. See Exterior Shelf (ES12...) on page 361 and Modern Corner Shelf (MDCCRNSHLF) on page 360. When used with MDCCRNSHLF, four brackets are recommended.
- 1/4" material thickness.
- Not intended for cabinet or freestanding countertop support. For substantial weight support, use a floor mounted support such as a Decorative Leg.
- Must be properly installed into a structural member of the wall.
- Sold individually. Recommended to use two brackets on shelves up to 48" wide, additional brackets should be added on wider shelves.

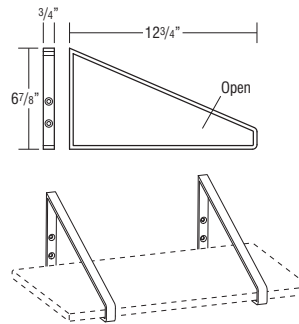

**INDUSTRIAL BRACKET, LOOP, 8 7/8" DEEP**

**BRACKETIND9SS**

**BRACKETIND9GMG**

**BRACKETIND9WI**

- On the stainless steel versions, the screws are countersunk.
- Finishes available: Stainless Steel (SS), Gun Metal Gray (GMG), and Wrought Iron (WI).
- Open area for 8" deep shelf placement is 15/16" high, shelf is to be secured with a screw in the bottom loop.
- Pre-drilled mounting holes for easy installation.
- 1/4" material thickness.
- Must be properly installed into a structural member of the wall.
- Sold individually. Recommended to use two brackets on shelves up to 48" wide, additional brackets should be added on wider shelves.

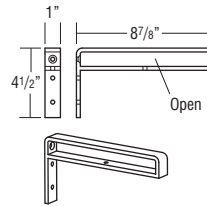

**INDUSTRIAL BRACKET, LOOP, 12 7/8" DEEP**

**BRACKETIND13SS**

**BRACKETIND13GMG**

**BRACKETIND13WI**

- On the stainless steel versions, the screws are countersunk.
- Finishes available: Stainless Steel (SS), Gun Metal Gray (GMG), and Wrought Iron (WI).
- Open area for 12" deep shelf placement is 15/16" high, shelf is to be secured with a screw in the bottom loop.
- Pre-drilled mounting holes for easy installation.
- 1/4" material thickness.
- Must be properly installed into a structural member of the wall.
- Sold individually. Recommended to use two brackets on shelves up to 48" wide, additional brackets should be added on wider shelves.

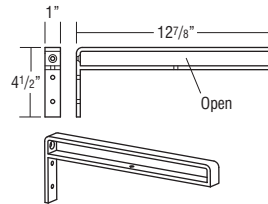

**DESCRIPTION**

**MODEL**

**INDUSTRIAL BRACKET,  
STRAIGHT, 8 1/2" DEEP**

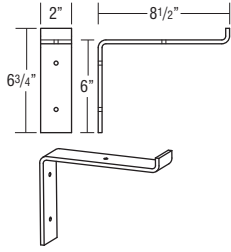

**STBRACKETIND9SS  
STBRACKETIND9G  
STBRACKETIND9WI**

- On the stainless steel versions, the screws are countersunk.
- Finishes available: Stainless Steel (SS), Gun Metal Gray (G), and Wrought Iron (WI).
- Pre-drilled mounting holes for easy installation.
- 1/4" material thickness.
- Not intended for cabinet or freestanding countertop support. For substantial weight support, use a floor mounted support such as a Decorative Leg.
- Must be properly installed into a structural member of the wall.
- Sold individually. Recommended to use two brackets on shelves up to 48" wide, additional brackets should be added on wider shelves.

**INDUSTRIAL BRACKET,  
STRAIGHT, 12 1/2" DEEP**

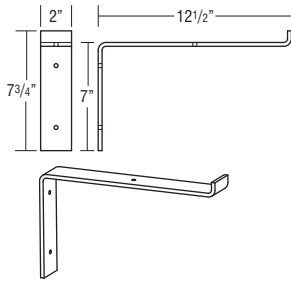

**STBRACKETIND13S  
STBRACKETIND13G  
STBRACKETIND13W**

- On the stainless steel versions, the screws are countersunk.
- Finishes available: Stainless Steel (S), Gun Metal Gray (G), and Wrought Iron (W).
- Pre-drilled mounting holes for easy installation.
- 1/4" material thickness.
- Not intended for cabinet or freestanding countertop support. For substantial weight support, use a floor mounted support such as a Decorative Leg.
- Must be properly installed into a structural member of the wall.
- Sold individually. Recommended to use two brackets on shelves up to 48" wide, additional brackets should be added on wider shelves.

**SHELF SUPPORT BRACKET,  
SATIN NICKEL**

**SHELFBRKTSN**

- Sold in pairs.
- Can be used with glass shelves 0.28"-0.75" (7-19mm) thick, or wood shelves 0.5"-1.61" (12-41mm) thick.
- Must be properly installed into a structural member of the wall.
- Maximum shelf load varies with shelf depth. For a 12" deep shelf, maximum shelf load is 50 lbs. each including shelf weight.

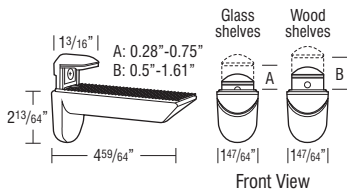

**DESCRIPTION**

**MODEL**

**SHELVES**

**FLOATING SHELVES**

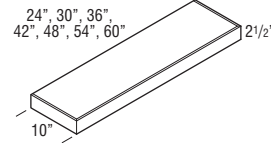

Maximum Weight Capacity per Shelf	
FS24	25 lbs.
FS30	31 lbs.
FS36	37 lbs.
FS42	43 lbs.
FS48	50 lbs.
FS54	56 lbs.
FS60	62 lbs.

**FS24  
FS30  
FS36  
FS42  
FS48 ♦  
FS54 ♦  
FS60 ♦**

- 3/4" thick solid-wood front, back, and ends. 3/8" thick veneered Medium Density Fiberboard (MDF) top and bottom. When a Paint finish is specified, veneer may not be applied. Front and ends are mitered together.
- Includes wood mounting plate with metal brackets. Once installed, mounting system is fully concealed.
- Not trimmable.

**Finish Techniques**

Distressing	Heirlooming

**Species Availability (Wood)**

	Rustic Alder	Cherry	Rustic Hickory	Maple	Oak
Alder	•				
Alder		•			

♦ Only available in Cherry and Maple.

**Species Availability (All Laminates)**

High Gloss	Horiz. Grain on Maple	Vert. Grain on Maple	Vert. Grain on Cherry	Vert. Grain on Oak
box color	box color	box color	box color	box color

♦ Only available in Cherry and Maple box colors.

**FLOATING SHELVES,  
STAINLESS STEEL**

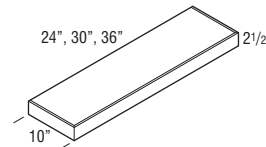

Maximum Weight Capacity per Shelf	
SSFSH2410	40 lbs.
SSFSH3010	50 lbs.
SSFSH3610	60 lbs.

**SSFSH2410  
SSFSH3010  
SSFSH3610**

- Stainless steel shell on wood frame. Includes hanging bracket and installation hardware.
- Includes wood mounting plate with metal brackets. Once installed, mounting system is fully concealed.

**MODERN CORNER SHELF,  
30" x 30" x 3/4"**

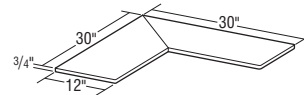

**MDCCRNHLF**

- Constructed of 3/4" wood panels.
- Top, bottom, front, and sides are finished, back two edges are not finished.
- Compatible with the Mid-century Triangle Bracket (TRIBRKT12\_\_, see page 359).

**Finish Techniques**

Distressing	Heirlooming
	•

**Species Availability (Wood)**

	Rustic Alder	Cherry	Rustic Hickory	Maple	Oak
Alder	•				
Alder		•			

**Species Availability (All Laminates)**

High Gloss	Horiz. Grain on Maple	Vert. Grain on Maple	Vert. Grain on Cherry	Vert. Grain on Oak
box color	box color	box color	box color	box color

**DESCRIPTION**

**MODERN CORNER  
FLOATING SHELF,  
30" x 30" x 2 1/2"**

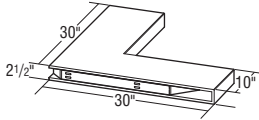

**MODEL**

**MDFLCRNSHLF**

- Installation kit included.
- Maximum weight capacity is 52 lbs.
- 3/4" thick solid-wood front and ends. 3/8" thick veneered top and bottom.
- Not trimmable.

**Finish Techniques**

Distressing	Heirlooming
	•

**Species Availability (Wood)**

Rustic Alder	Cherry	Rustic Hickory	Maple	Oak
• Alder	•		•	•

**Species Availability (All Laminates)**

High Gloss	Horiz. Grain on Maple	Vert. Grain on Maple	Vert. Grain on Cherry	Vert. Grain on Oak
box color	box color	box color	box color	box color

**DESCRIPTION**

**EXTERIOR SHELVES,  
12", 18", 21", or 24" DEEP**

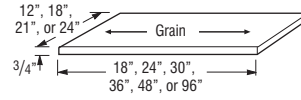

**ES1218**

**ES1224**

**ES1230**

**ES1236**

**ES1248**

**ES1296†**

**ES1818**

**ES1824**

**ES1830**

**ES1836**

**ES1848**

**ES1896†**

**ES2118**

**ES2124**

**ES2130**

**ES2136**

**ES2148**

**ES2196†**

**ES2418**

**ES2424**

**ES2430**

**ES2436**

**ES2448**

**ES2496†**

- Wood 3/4" panels are veneered furniture board finished both sides, and front and side edges (back edge is not finished).
- Not available in wood grain laminates.
- Shelves can be ordered in APC.

†5 day Express Response not available on items over 48".

**Custom Modifications**

ID	RD
•	•

**Finish Techniques**

Distressing	Heirlooming

**Species Availability (Wood)**

Rustic Alder	Cherry	Rustic Hickory	Maple	Oak
• Alder	•	• Hickory	•	•

**Species Availability (All Laminates)**

High Gloss	Horiz. Grain on Maple	Vert. Grain on Maple	Vert. Grain on Cherry	Vert. Grain on Oak
box color	box color	box color	box color	box color

**DESCRIPTION**

**MODEL**

**FULL DEPTH INTERIOR SHELVES**

To Fit 12" & 24" Deep Cabinets

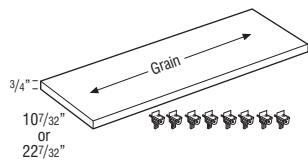

- SK912
- SK1212
- SK1512
- SK1812
- SK2112
- SK2412
- SK2712
- SK3012
- SK3312
- SK3612
- SK3912
- SK4212
- SK4812

- SK924
- SK1224
- SK1524
- SK1824
- SK2124
- SK2424
- SK2724
- SK3024
- SK3324
- SK3624
- SK3924
- SK4224
- SK4824

- SK\_\_12 includes one 10 7/32" deep shelf. SK\_\_24 includes one 22 7/32" deep shelf.
- Each kit includes 8 shelf pegs.
- Shelving material specific to construction option. See page 36 for construction details.
- Specify material when ordering.
- Full Depth Shelves will be shipped separate from the cabinet.
- If matching interior is desired, order shelf kit (SK\_\_\_\_) with Matching Interior Plywood (MIP) modification.

**Custom Modifications**

ID	MIP	RD	WLI
•	•	•	•

**Construction Upgrades**

APC
•

**DESCRIPTION**

**MODEL**

**GLASS SHELF KIT, 9" DEEP**

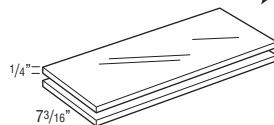

- JGSK1209
- JGSK1509
- JGSK1809
- JGSK2109
- JGSK2409
- JGSK2709
- JGSK3009
- JGSK3309
- JGSK3609

- JGSK cannot be trimmed.
- Kit includes two 1/4" glass shelves.
- Example: JGSK1209 = 10 9/32" x 7 3/16" to fit W1230x9 cabinet.
- Not compatible with the FFD modification.
- All glass shelf kits will be drop shipped separately from the cabinet order.

**GLASS SHELF KIT, 12" DEEP**

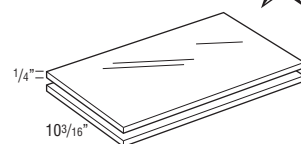

- JGSK912
- JGSK1212
- JGSK1512
- JGSK1812
- JGSK2112
- JGSK2412
- JGSK2712
- JGSK3012
- JGSK3312
- JGSK3612

- JGSK cannot be trimmed.
- Kit includes two 1/4" glass shelves.
- Example: JGSK1512 = 13 9/32" wide x 10 3/16" deep fits in W1530x12 Deep Cabinet.
- All glass shelf kits will be drop shipped separately from the cabinet order.

**Custom Modifications**

ID	RD
•	

**GLASS SHELF KIT, DIAGONAL**

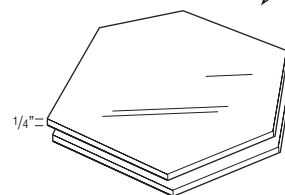

- JGSKDW24 (Fits DW..2424)
- JGSKDW27 (Fits DW..2727)

- JGSK cannot be trimmed.
- Kit includes two 1/4" glass shelves.
- Not available for 24" and 27" high Diagonal Wall cabinets. Shelf will not fit through door opening.
- Not available for Diagonal Wall cabinets specified with Peninsula modification.
- All glass shelf kits will be drop shipped separately from the cabinet order.



**DESCRIPTION**

**MODEL**

**LIGHTING**

- LEDs are a solid state lighting source. LEDs are more efficient, durable, and safer than older light sources.
- CW = Cool White (Kelvin rating: 5000)
- WW = Warm White (Kelvin rating: 3200)
- Installed lighting products are not available in California, with the exception of the Battery Strip Light (BATTLT1).

**LED PUCK LIGHTING, STANDARD**



**PUCK18CW  
PUCK18WW**



- Contains 18 LED diodes with a life span of 50,000 hours.
- Measures less than 1/4" for low profile surface mounting.
- 65° beam angle.
- Compatible with Dimmable Driver (DIMM241512) and Power Extension Cable (CABL2500).
- Available in: warm or cool white in plastic housing with an aluminum color finish.
- Puck dimension is 2.56" x 2.56" (65mm x 65mm).
- Power usage: 1.25 watts.
- Voltage: 24V Compatibility.

**LED PUCK LIGHTING, HIGH DEFINITION**



**PUCK24WW**

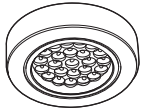

surface mount

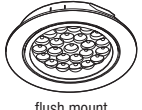

flush mount

- Contains 24 LED diodes with a life span of 50,000 hours.
- Surface or flush mounted (remove ring for flush mounting).
- 50° beam angle.
- Compatible with Dimmable Driver (DIMM241512) and Power Extension Cable (CABL2500).
- Available in: warm or cool white light in aluminum housing.
- Puck diameter is 2.58" (65.5mm) and height is 0.41" (10.5mm).
- Power usage: 1.65 watts.
- Voltage: 24V Compatibility.

**LED FLEXIBLE STRIP**



**FLEX12CW  
FLEX12WW  
FLEX36WW**

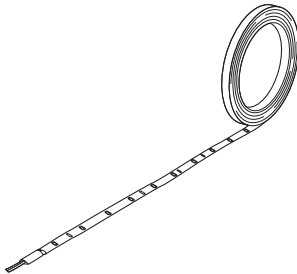

- Linkable and trimmable in increments of either 3" (FLEX12..) or 3 1/4" (FLEX36..), not to exceed a total of 18'.
- Adhesive back.
- Compatible with Dimmable Driver (DIMM121512) and Flex Driver Connection Lead (LEADDFLX2500).
- Suggested use: installed over cabinet, under cabinet, in cabinet, and on the toekick.
- Available in: warm or cool white.
- FLEX12.. Dimensions: Length 11.81" (300mm), Width 0.31" (8mm), and Depth 0.1" (2.5mm).
- FLEX36.. Dimensions: Length: 39.37" (1000mm), Width 0.31" (8mm), and Depth 0.1" (2.5mm).
- Power usage: 0.8 watts (FLEX12..) and 2.5 watts (FLEX36..).
- Voltage: 12V Compatibility.

**DESCRIPTION**

**MODEL**

**LED RIGID STRIP**



**RIGID12CW  
RIGID12WW  
RIGID24WW**



- Linkable.
- Suggested use: straight runs (use link wires for corners).
- Available in 12 or 24 diodes per stick.
- Easy-to-clean, protective shell.
- Compatible with Dimmable Driver (DIMM121512) and Rigid Driver Connection Cable (CABLRIDG2500).
- Available in: warm or cool white.
- Includes brackets and screws for easy installation.
- 50,000 hour life span.
- Dimensions (12 Diodes): Length 11.81" (300mm), Width 0.31" (8mm), and Depth 0.24" (6mm).
- Dimensions (24 Diodes): Length 11.22" (285mm), Width 0.31" (8mm), and Depth 0.24" (6mm).
- Power usage: 0.8 watts (RIGID12..) and 1.5 watts (RIGID24..).
- Voltage: 12V Compatibility.

**BATTERY STRIP LIGHT**



**BATTLT1**

- Battery operated – (4) AAA batteries (not included).
- Motion activated.
- Low power usage (0.3W).
- Plastic aluminum finish.
- Dimensions: Length 11.93" (303mm), Width 0.67" (17mm), and Depth 0.55" (14mm).
- Easy adhesive install.

**STANDARD DRIVERS**

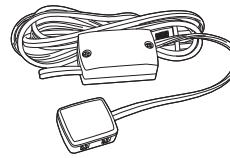

**STAND1264  
STAND2464**

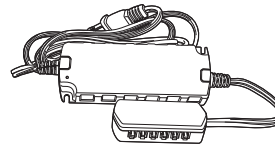

**STAND121512**

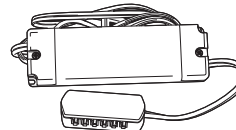

**STAND123012  
STAND243012**

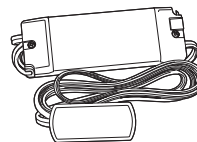

**STAND242012**

**STAND1264**

**STAND2464**

**STAND121512**

**STAND123012**

**STAND243012**

**STAND242012**

- Product Codes list the driver voltage, watts, and connector ports, such as STAND123012 is 12V, 30W, and 12 connector ports.

	Voltage	Wattage (Max Load)	Connector Ports
STAND1264	12	6	4
STAND2464	24	6	4
STAND121512	12	15	12
STAND123012	12	30	12
STAND243012	24	30	12
STAND242012	24	20	12

**DESCRIPTION**

**MODEL**

**AC DIMMABLE DRIVERS (DAYBREAK)**



**DIMM121512  
DIMM241512**

- Compatible with most standard wall dimmers.
- Drivers can be hard wired or used with included plug head. Multiple drivers can be used with a single wall dimmer switch and voltages can be mixed.

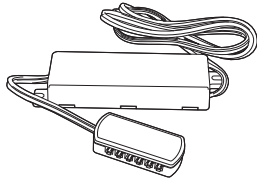

	Voltage	Wattage (Max Load)	Connector Ports
DIMM121512	12	15	12
DIMM241512	24	15	12

**INFRARED LIGHT SWITCH**



**IR1224**

- Compatible with both 12V and 24V products.
- Can be installed inside or under a cabinet or recessed into moulding. Turns on and off by passing hand in front of it or when cabinet door is opened or closed.

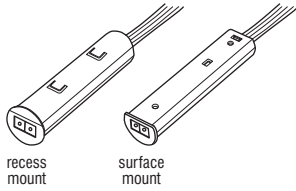

recess mount

surface mount

**LIGHTING ACCESSORIES**

- LEDs are a solid state lighting source. LEDs are more efficient, durable, and safer than older light sources.

**POWER EXTENSION CABLE**



**CABL2500**

- Provides an additional 98.43" to reach those fixtures which are out of reach with the standard power leads.
- Features a male connector on one end and a female connector on the other.
- Compatible with PUCK18\_\_ and PUCK24\_\_.

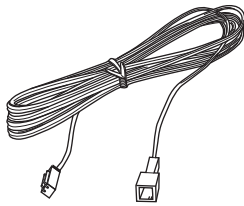

**FLEX DRIVER CONNECTION LEAD**



**LEADFLX2500**

- Required part for each LED flexible strip series, connects the first LED flexible strip in the series to the driver.
- Lead length is 98".
- Compatible with FLEX12\_\_ and FLEX36\_\_.

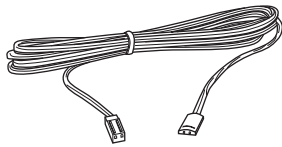

**FLEX INTER CONNECTIONS**



**CONNFLXCRN50  
LEADFLXIC500  
LEADFLXIC1500**

- Used with the LED flexible strips to connect strips together while allowing a gap between sections.
- CONNFLXCRN50 is 1.97" (50mm) and is recommended for the connection of two flexible strips around a corner.
- LEADFLXIC500 is 19.69" (500mm), suggested use is around small obstructions.
- LEADFLXIC1500 is 59" (1500mm), suggested use is around large appliances such as microwaves and refrigerators.
- Compatible with FLEX12\_\_ and FLEX36\_\_.

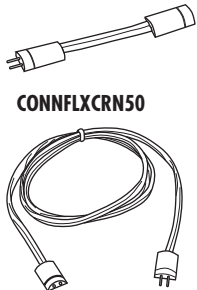

LEADFLXIC500  
LEADFLXIC1500

**DESCRIPTION**

**MODEL**

**RIGID DRIVER CONNECTION CABLE**



**CABLRIGD2500**

- Required to connect the first LED strip in a series to the driver.
- Cable length is 98".
- Compatible with RIGID12\_\_ and RIGID24\_\_.

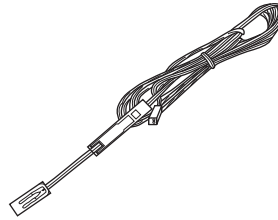

**RIGID INTER CONNECTIONS**



**CABLRIGCRN30**

**CABLRIGIC300**

**LEADRIC1500**

- Used with the LED rigid strips to connect strips together while allowing a gap between sections.
- CABLRIGCRN30 is 1.18" (30mm) and is recommended for the connection of two rigid strips around a corner.
- CABLRIGIC300 is 11.81" (300mm).
- LEADRIC1500 is 59" (1500mm), suggested use is around large appliances such as microwaves and refrigerators.
- Compatible with RIGID12\_\_ and RIGID24\_\_.

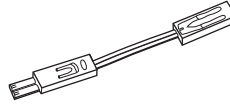

CABLRIGCRN30

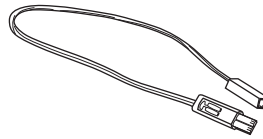

CABLRIGIC300

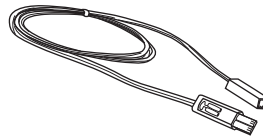

LEADRIC1500

**RIGID STRIP END CAP**



**ENDRIG**

- Used to provide a clean and professional termination of the rigid strip light series.
- Compatible with RIGID12\_\_ and RIGID24\_\_.

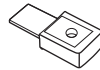

**QUATTRO DIMMING RECEIVER**



**QDIMREC**

- Wireless RF control for an easy, no wire installation.
- Unlimited receiver locations per zone.
- Up to 100' of wireless operation even through obstacles like walls.
- 256 levels of extra smooth dimming.
- Soft start On/Off for gradual dimming.



**QUATTRO WALL CONTROLLER**



**Q4ZONECON**

- Wireless RF control for an easy, no wire installation.
- Unlimited receiver locations per zone with Quattro Dimming Receiver.
- Detachable face for easy handheld remote operation and battery changing.
- Up to 100' of wireless operation even through obstacles like walls.
- Multiple switches per zone for easy 2, 3, or 4 way control.
- Can be ganged (grouped) with wall switches or outlets behind a single cover plate.
- Includes low cost, long life lithium 3V battery for up to 10 years of operation.

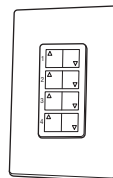

**DESCRIPTION MODEL**  
**DECORATIVE HARDWARE - KNOBS & PULLS**

**ANTIQUE PEWTER**



**KNOBM148**  
 L: 2 5/8"  
 W: 5/8"  
 P: 1 1/4"



**KNOBM206**  
 D: 1 1/4"  
 P: 1 1/16"



**PULLM364**  
 C/C: 3"  
 L: 4 5/8"  
 W: 1 7/16"  
 P: 15/16"



**PULLM475**  
 C/C: 3 3/4"  
 L: 5"  
 W: 9/16"  
 P: 1"

**BLACK**



**KNOBT1017**  
 C/C: 1 1/4"  
 L: 2"  
 W: 11/16"  
 P: 1 1/4"  
 Pairs best with PULLT1015



**PULLT1015**  
 C/C: 7"  
 L: 8"  
 W: 11/16"  
 P: 1 1/2"  
 Pairs best with KNOBT1017

**D** = Diameter  
**P** = Projection (Hardware Depth)  
**L** = Length  
**W** = Width  
**B** = Base  
**C/C** = Center to Center

Installation screws included with each hardware piece.  
 Breakoff screws available for purchase separately as BRKOFFSCREW, see page 383.  
 Larger pulls may not be compatible with 5-piece drawer fronts on face frame openings of 9" wide or less.  
 See page 81 for 5-piece drawer front dimensions when specifying decorative hardware.

**DESCRIPTION MODEL**

**BLACK (cont'd)**



**KNOB1912**  
 D: 1 1/4"  
 P: 1 13/16"



**KNOBH951**  
 L: 1 3/4"  
 W: 1"  
 P: 1"  
 B: 1 1/16" x 1/2"



**PULLH952**  
 C/C: 3"  
 L: 4 1/4"  
 W: 1 1/2"  
 P: 11/16"



**PULLM383**  
 C/C: 5 1/16"  
 L: 6"  
 W: 1/2"  
 P: 1 1/16"

**BLACK IRON**



**KNOB1901**  
 L: 1 7/16"  
 W: 1 1/4"  
 P: 1 1/8"  
 B: 15/16"



**PULL1902**  
 C/C: 128mm  
 L: 6 1/3"  
 W: 1 1/10"  
 P: 1 1/16"





**BLACK MIST**







**KNOBH116**  
 L: 1 5/16"  
 W: 1 1/4"  
 P: 1 1/8"  
 B: 3/8"



**PULLH115**  
 C/C: 128mm  
 L: 6 3/8"  
 W: 1/2"  
 P: 1"





DESCRIPTION	MODEL
<b>BLACKENED BRONZE</b> 	
	<b>KNOBH136</b> L: 1 3/4" W: 1/2" P: 1 1/8" B: 1/2"
	<b>PULLH130</b> C/C: 128mm L: 6 3/8" W: 7/16" P: 1 1/8"
	<b>PULLH132</b> C/C: 224mm L: 10" W: 1/2" P: 1 3/8"

<b>BRONZE HIGHLIGHT</b> 	
	<b>KNOBRH20</b> L: 1 7/16" W: 1 7/16" P: 1 3/32"
	<b>PULLRH21</b> C/C: 3" L: 4 39/64" W: 25/32" P: 1 3/16"

<b>CAST IRON</b> 	
	<b>KNOBM1820</b> L: 1 5/16" W: 1 5/16" P: 1"
	<b>PULLM1823</b> C/C: 5 1/16" L: 7 3/8" W: 1" P: 1 1/4"

**D** = Diameter  
**P** = Projection (Hardware Depth)  
**L** = Length  
**W** = Width  
**B** = Base  
**C/C** = Center to Center

Installation screws included with each hardware piece.  
 Breakoff screws available for purchase separately as BRKOFFSCREW, see page 383.  
 Larger pulls may not be compatible with 5-piece drawer fronts on face frame openings of 9" wide or less.  
 See page 81 for 5-piece drawer front dimensions when specifying decorative hardware.

DESCRIPTION	MODEL
<b>CHROME</b> 	
	<b>KNOB1906</b> L: 1 1/16" W: 1 1/16" P: 1 1/8" B: 3/8"
	<b>PULL1905</b> C/C: 128mm L: 6 3/8" W: 9/16" P: 1"
	<b>PULL1904</b> C/C: 3 3/4" L: 5 1/4" W: 1" P: 1"

<b>GOLD</b> 	
	<b>KNOB1908</b> L: 1 1/4" W: 1 1/4" P: 1" B: 3/8" Pairs best with PULL1907
	<b>PULL1907</b> C/C: 160mm L: 6 7/10" W: 2/5" P: 1 1/5" Pairs best with KNOB1908
	<b>KNOB1909</b> L: 1 1/4" W: 1 1/4" P: 1 1/8" B: 3/4" Pairs best with PULL1910 or PULL1911
	<b>PULL1910</b> C/C: 224mm L: 9 9/16" W: 3/4" P: 1 5/16" Pairs best with KNOB1909 or PULL1911
	<b>PULL1911</b> C/C: 192mm L: 8 3/8" W: 3/4" P: 1 1/4" Pairs best with KNOB1909 or PULL1910

**DESCRIPTION**

**MODEL**

**HAMMERED  
BRONZE**



**KNOBH913**  
L: 1 3/8"  
W: 1 3/8"



**PULLH911**  
C/C: 3"  
L: 5 5/8"  
W: 1"  
P: 1 1/4"

**ICE TEA**



**KNOBH108**  
L: 1 7/16"  
W: 1 1/16"  
P: 1"  
B: 1/2"



**PULLH144**  
C/C: 160mm  
L: 6 5/16"  
W: 9/16"  
P: 1 1/16"

**D** = Diameter  
**P** = Projection (Hardware Depth)  
**L** = Length  
**W** = Width  
**B** = Base  
**C/C** = Center to Center

Installation screws included with each hardware piece.  
Breakoff screws available for purchase separately as BRKOFFSCREW, see page 383.  
Larger pulls may not be compatible with 5-piece drawer fronts on face frame openings of 9" wide or less.  
See page 81 for 5-piece drawer front dimensions when specifying decorative hardware.

**DESCRIPTION**

**MODEL**

**SATIN NICKEL**



**KNOBT002**  
C/C: 1 1/4"  
L: 2"  
W: 3/8"  
P: 1 1/2"  
Pairs best with PULLT001



**PULLT001**  
C/C: 7"  
L: 8"  
W: 3/8"  
P: 1 1/2"  
Pairs best with KNOBT002



**PULLH120**  
C/C: 160mm  
L: 7 1/8"  
W: 3/4"  
P: 1"  
Pairs best with PULLH122



**PULLH122**  
C/C: 12"  
L: 12 3/4"  
W: 7/8"  
P: 1 3/16"  
Pairs best with PULLH120



**PULLH105**  
C/C: 1"  
L: 1 3/4"  
W: 1"  
P: 1 3/4"  
Pairs best with PULLH106 or PULLH107



**PULLH106**  
C/C: 160mm  
L: 7"  
W: 1"  
P: 1 3/4"  
Pairs best with PULLH105 or PULLH107



**PULLH107**  
C/C: 12"  
L: 13"  
W: 1"  
P: 1 13/16"  
Pairs best with PULLH105 or PULLH106

**DESCRIPTION** **MODEL**

**SATIN NICKEL**  
(cont'd) 



**KNOB1420**  
D: 1 1/4"  
P: 1 1/8"



**KNOBH100**  
D: 1 3/8"  
P: 1 3/8"  
B: 3/4"



**KNOBH118**  
L: 1 5/16"  
W: 1 5/16"  
P: 1 3/16"  
B: 7/8"



**KNOBM549**  
D: 7/8"  
P: 1"



**PULLH50**  
C/C: 5"  
L: 5"  
W: 5/16"  
P: 1 1/4"



**PULLH63**  
C/C: 96mm  
L: 4 1/8"  
W: 1/2"  
P: 1 1/16"



**PULLH957**  
C/C: 3"  
L: 4 1/4"  
W: 1 1/2"  
P: 11/16"

**D** = Diameter  
**P** = Projection (Hardware Depth)  
**L** = Length  
**W** = Width  
**B** = Base  
**C/C** = Center to Center

Installation screws included with each hardware piece.  
Breakoff screws available for purchase separately as BRKOFFSCREW, see page 383.  
Larger pulls may not be compatible with 5-piece drawer fronts on face frame openings of 9" wide or less.  
See page 81 for 5-piece drawer front dimensions when specifying decorative hardware.

**DESCRIPTION** **MODEL**

**SATIN NICKEL**  
(cont'd) 



**PULLM381**  
C/C: 5 1/16"  
L: 6"  
W: 1/2"  
P: 1 1/16"



**PULLM430**  
C/C: 5 1/16"  
L: 7"  
W: 15/32"  
P: 1 7/16"



**PULLM570**  
C/C: 5 1/16"  
L: 5 7/8"  
W: 1/2"  
P: 1 3/16"

**SILVER STONE** 



**KNOBH127**  
D: 1 1/2"  
P: 1"  
B: 7/8"



**PULLH128**  
C/C: 160mm  
L: 7 1/2"  
W: 3/4"  
P: 1 1/16"

**DESCRIPTION**

**MODEL**

**STAINLESS STEEL**



**KNOBH135**

L: 1 3/4"  
W: 1/2"  
P: 1 1/8"  
B: 1/2"  
Pairs best with PULLH129  
or PULLH131



**PULLH129**

C/C: 128mm  
L: 6 3/8"  
W: 7/16"  
P: 1 1/8"  
Pairs best with KNOBH135  
or PULLH131



**PULLH131**

C/C: 224mm  
L: 10"  
W: 1/2"  
P: 1 3/8"  
Pairs best with KNOBH135  
or PULLH129



**PULLH141**

C/C: 128mm  
L: 7 3/8"  
W: 1/2"  
P: 1 1/4"  
Pairs best with PULLH142  
or PULLH143

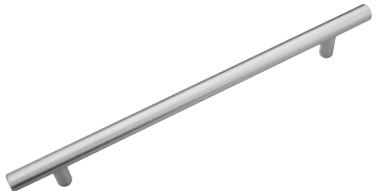

**PULLH142**

C/C: 192mm  
L: 9 15/16"  
W: 1/2"  
P: 1 1/4"  
Pairs best with PULLH141  
or PULLH143



**PULLH143**

C/C: 384mm  
L: 17 1/2"  
W: 1/2"  
P: 1 1/4"  
Pairs best with PULLH141  
or PULLH142

**D** = Diameter  
**P** = Projection (Hardware Depth)  
**L** = Length  
**W** = Width  
**B** = Base  
**C/C** = Center to Center

Installation screws included with each hardware piece.  
Breakoff screws available for purchase separately as BRKOFFSCREW, see page 383.  
Larger pulls may not be compatible with 5-piece drawer fronts on face frame openings of 9" wide or less.  
See page 81 for 5-piece drawer front dimensions when specifying decorative hardware.

**DESCRIPTION**

**MODEL**

**TUSCAN BRONZE**



**KNOBH117**

L: 1 5/16"  
W: 1 5/16"  
P: 1 3/16"  
B: 7/8"  
Pairs best with PULLH119



**PULLH119**

C/C: 160mm  
L: 7 1/8"  
W: 3/4"  
P: 1"  
Pairs best with KNOBH117



**KNOBTO13**

D: 1 1/4"  
P: 1 1/16"



**PULLM1674**

C/C: 3"  
L: 4 5/8"  
W: 1 7/16"  
P: 15/16"



**PULLT1018**

C/C: 5 1/16"  
L: 6"  
W: 1/2"  
P: 1 1/16"

**DESCRIPTION MODEL**

**DECORATIVE HARDWARE - FAUX HINGES**

- Faux Strap Hinge: For 12"-33" high doors use 2 faux hinges. For 36" high and above use 3 faux hinges.
- Faux Barrel Hinge: For 12"-36" high doors use 2 faux hinges. For 39" high and above use 3 faux hinges.
- Requires field installation.
- For use with Door 26 door style.
- 1/4" space filler or extended stile modification recommended when applying faux hinges (strap or barrel) on cabinets with varied depths or next to an appliance to allow for full swing clearance.

**BRONZE HIGHLIGHT**



**HINGEFH1**  
Faux Barrel Hinge  
Pairs best with the following hardware finishes:  
Black Iron  
Blackened Bronze  
Bronze Highlight  
Cast Iron  
Hammered Bronze  
Ice Tea  
Silver Stone  
Tuscan Bronze

**PEWTER**



**HINGEFH2**  
Faux Barrel Hinge  
Pairs best with the following hardware finishes:  
Antique Pewter  
Black  
Black Mist  
Blackened Bronze  
Chrome

**BLACK**



**HINGEFH3**  
Faux Strap Hinge  
Pairs best with the following hardware finishes:  
Antique Pewter  
Black  
Black Iron  
Black Mist  
Blackened Bronze  
Bronze Highlight  
Cast Iron  
Chrome  
Hammered Bronze  
Ice Tea  
Satin Nickel  
Silver Stone  
Stainless Steel

**DESCRIPTION MODEL**

**ACCESSORIES**

**BASE MIXER KIT**



**MIXKITFHSC18**  
**MIXKITFHSC21**  
**MIXKITFHSC24**

- Smart close closing feature.
- Mixer shelf will be 3/4" thick natural finished veneer plywood, mixer shelf dimensions:  
18" wide: 11 3/4" wide x 20" deep.  
21" wide: 14 3/4" wide x 20" deep.  
24" wide: 17 3/4" wide x 20" deep.
- Maximum Weight Capacity for Mixer Shelf: 60 lbs.
- Mixer shelf locks in the fully open position. Release brackets lower the mixer shelf back into the cabinet.
- When in closed position, clearance above shelf is 17 5/8"; clearance below shelf is 7 3/4".
- Recommended for use in cabinets specified with APC.

**BASE PAN STORAGE**

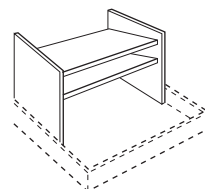

**BPS24**  
**BPS30**  
**BPS36**

Model	Application
BPS24	24" Base
BPS30	30" Base
BPS36	36" Base

- Roll tray not included.
- Insert consists of solid Maple sides and shelves. Back is edgebanded plywood.

**BASE WASTEBASKET LIDS**

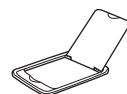

**BWBLID**  
**BWBFHLID**

- Designed to be used with BWB\_\_\_, DWB\_\_\_, and VWB\_\_\_ Lids are included with BBTP\_\_\_.
- BWBLID fits 35 quart wastebaskets. On double wastebasket cabinets, BWBLID can only be used on the front wastebasket.
- BWBFHLID fits 50 quart wastebaskets.
- Sold individually.

Model	BWBLID (35 qt. wastebasket)	BWBFHLID (50 qt. wastebasket)
BWB15	✓	
BWB152		
BWB18	✓	
BWB21	✓	
BWB15FH		✓
BWB18FH		✓
BWB15FH2		
BWB18FH2	Front only	
BWB15FHRT2		
BWB18FHRT2	Front only	
BWB21FH		Front only
BPT15WB		
BPT18WB		
BPT15WBFH		
BPT18WBFH		
DWB152921FH	✓	
DWB182921FH	✓	
DWB152924FH	✓	
DWB182924FH	Front only	
VWB153421	✓	
VWB153221	✓	
VWB153221RT		
VWB153421	✓	
VWB153421RT	✓	



**DESCRIPTION**

**MODEL**

**BROOM CLIP**



**BRMCLP**

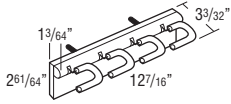

**CABMAT™**



**CABMAT30  
CABMAT33  
CABMAT36**

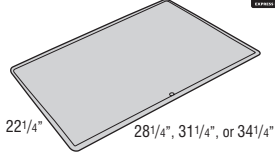

- Designed to capture spills and is removable for cleaning.
- See CabMat™ modification for easy size selection by cabinet model.
- Not trimmable. Can also be used in wider cabinets but will create a small void of unprotected area along the end panels.

Model	Liquid Capacity		Cabinet Size	
	Gallons	Liters	Width	Depth
CABMAT30	2.0	7.6	30"	24"
CABMAT33	2.4	9.0	33"	24"
CABMAT36	2.7	10.2	36"	24"

**CABMAT™ VANITY**



**CABMATV24  
CABMATV30  
CABMATV36**

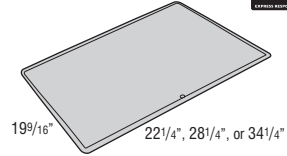

- Designed to capture spills and is removable for cleaning.
- See CabMat™ modification for easy size selection by cabinet model.
- Not trimmable. Can also be used in wider cabinets but will create a small void of unprotected area along the end panels.

Model	Liquid Capacity		Cabinet Size	
	Quarts	Liters	Face Frame Opening	Depth
CABMATV24	2.5	2.4	21"-24"	21"
CABMATV30	3.3	3.1	27"-30"	21"
CABMATV36	3.9	3.7	33"	21"

**DESCRIPTION**

**MODEL**

**COOKING UTENSIL DIVIDER**



**CUDD24  
CUDD30  
CUDD36**

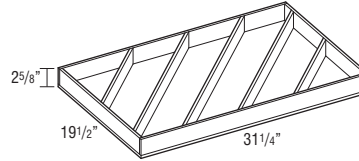
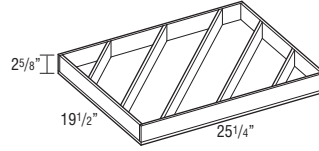
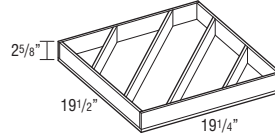

- Pre-assembled natural wood drawer insert (does not fit roll trays).

**CUTLERY INSERT WOOD ORGANIZER**



**CIW15  
CIW18  
CIW21  
CIW24**

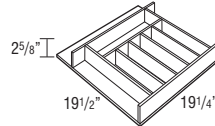
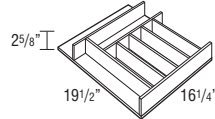
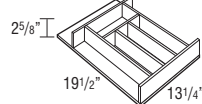
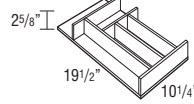

Model	Application
CIW15	15" Base
CIW18	18" Base
CIW21	21" Base
CIW24	24" Base

- Pre-assembled natural wood drawer insert.
- Place a cabinet with a CIW next to the dishwasher for convenience.

DESCRIPTION

MODEL

WOOD TIERED CUTLERY DIVIDER DRAWER



- WTCD15
- WTCD18
- WTCD21
- WTCD24
- WTCD30
- WTCD36

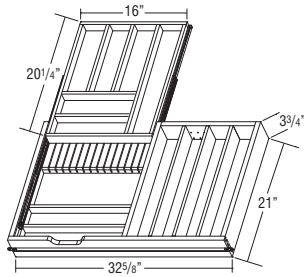
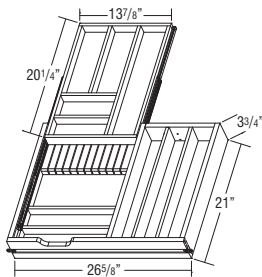
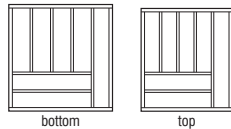
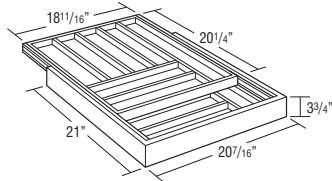
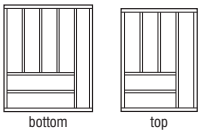
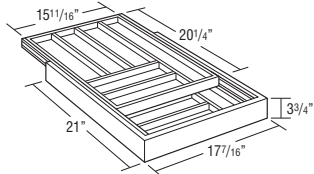
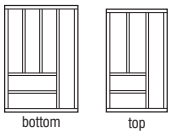
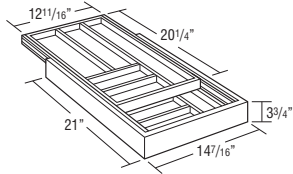
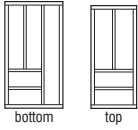
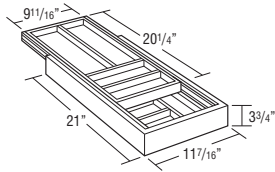

Model	Application
WTCD15	15" Base
WTCD18	18" Base
WTCD21	21" Base
WTCD24	24" Base
WTCD30	30" Base
WTCD36	36" Base

- Replaces standard drawer. Uses existing cabinet member drawer hardware.
- Requires field installation of drawer front.
- For use with 24" deep cabinets only.
- Exterior WTCD drawer box height is 3 3/4", interior height of top and bottom tier is 1 3/8".
- Top divider slides front-to-back.

DESCRIPTION

MODEL

WOOD TIERED K-CUP\* DRAWER

KCUP18

- Holds 40 K-Cups.
- Exterior Wood Tiered K-Cup drawer box height is 3 3/4", interior height of top tier is 1 5/8", and interior height of bottom tier is 1 3/8".
- The Wood Tiered K-Cup Drawer is compatible with K-Cup pods only.
- Replaces standard drawer. Uses existing cabinet member drawer hardware.
- Requires field installation of drawer front.
- Only for use with 24" deep cabinets that are 18" wide or have a 15" wide frame opening for the drawer.
- Top divider slides front-to-back.

\*K-Cup is a registered trademark of Keurig Green Mountain, Inc.

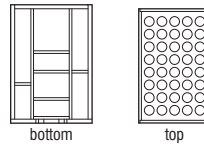
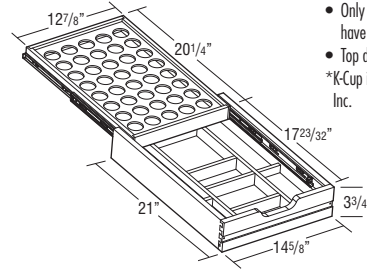

EDGEBANDING



EDGEBAND1OWD

EDGEBAND1OP

EDGEBAND1ONML

EDGEBAND1OWHL

- EdgEBANDing will come in a 10' length. Recommended for use on panels 3/4" thick or less, edgEBANDing width will need to be field-trimmed.
- Finger joints may be visible on unfinished veneer and clear coated edgEBANDing.
- EdgEBANDing does not come pre-glued.
- EDGEBAND1OWD is unfinished veneer, available in Alder, Cherry, Maple, Oak, Rustic Alder, and Rustic Hickory.
- EDGEBAND1OP is available in High Gloss Laminate AF, High Gloss Laminate AG, Laminate AH, Laminate AI, Laminate AJ, Laminate AK, Laminate AL, Laminate AM, and Laminate AN.
- EDGEBAND1ONML is Natural Maple Laminate.
- EDGEBAND1OWHL is White Laminate.

ANGLED HEAT SHIELDS



ANGLHEATSHIELD

ANGLSHIELDSS

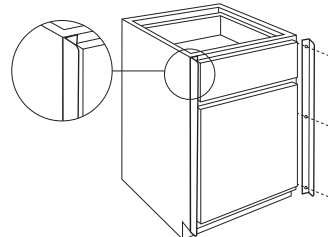
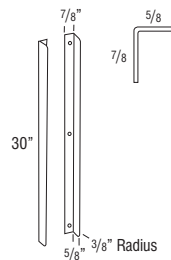

- ANGLHEATSHIELD is a pair of 1/16" thick, white powder coated metal shields.
- ANGLSHIELDSS is a pair of 1/16" thick, stainless steel metal shields.
- Heat Shield is used to deflect heat from self-cleaning ovens away from cabinet doors and drawer fronts.
- For use when additional 1/8" cannot be added to the oven manufacturer's recommended space requirement.
- Cabinet door cannot be hinged on the same side as the angled heat shield, not compatible with double door cabinets. Installs on the front of the face frame of each cabinet adjacent to the oven.

**DESCRIPTION**

**MODEL**

**STRAIGHT HEAT SHIELDS**

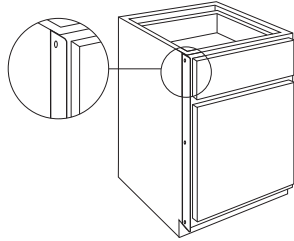
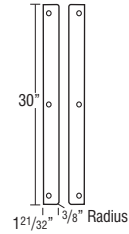

**STRTHEATSHIELD  
STRTHSHIELDSS**

- STRTHEATSHIELD is a pair of 1/16" thick, white powder coated metal shields.
- STRTHSHIELDSS is a pair of 1/16" thick, stainless steel metal shields.
- Heat Shield is used to deflect heat from self-cleaning ovens away from cabinet doors and drawer fronts.
- For use when additional 1/8" can be added to the oven manufacturer's recommended space requirement.
- Installs on the side of the face frame of each cabinet adjacent to the oven.

**K-CUP\* INSERT**

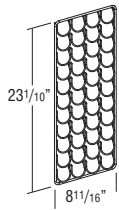

**WBCPOKUP**

- Holds 44 K-Cups, compatible with K-Cup pods only.
- Wire K-Cup rack for easy field installation on either the left or right side. Compatible with all heights of 3" wide box column pull-outs (WBCPO., see page 137). Depending on height of pull-out, shelves can be used above or below insert for additional storage:  
30" and 33" high include 4 shelves, not compatible with insert.  
36" and 39" high include 5 shelves, one shelf recommended for use with insert.  
42" high includes 6 shelves, two shelves recommended for use with insert.

\*K-Cup is a registered trademark of Keurig Green Mountain, Inc.

**LID ORGANIZERS**

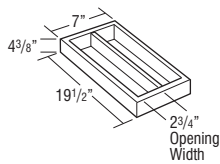

**LO**

- LO is designed to be in any standard roll tray in a 24" deep cabinet.

**LINEN CLOSET HAMPER  
LINER**

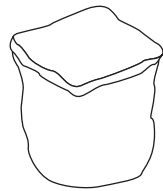

**LCHAMPERLNR**

- Replacement cloth liner for use with LCRH188421, L188421BH, VBH183421, and VH183221FH.

**DESCRIPTION**

**MODEL**

**OVEN INSTALLATION KIT**

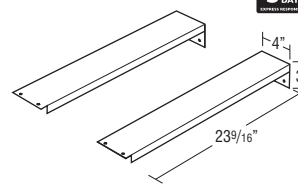

**OCINSTALLKIT**

- Recommended for supporting built-in appliances such as ovens, microwaves, and warming drawers. Refer to appliance manufacturer specifications for installation requirements.
- Weight limit is 400 lbs. per pair.

**PEGGED DISH ORGANIZER**

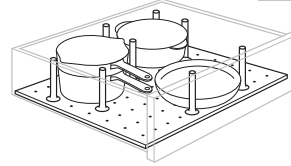

**PDO (8 Posts & Board)**

**PDOPOSTS (4 Posts)**

- For use in 36" wide drawer base cabinets in 6 3/8" or 10" deep drawers, trimmable for cabinets less than 36" wide. Not recommended for use in roll trays.
- Pegged Board is 19/32" thick.
- 29 15/16" x 19 1/2".
- Posts are 6" high.

**POTS & PANS PULL-OUT**

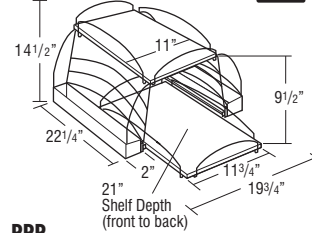

**PPP**

- For use in 24" wide cabinets.

**PPP**

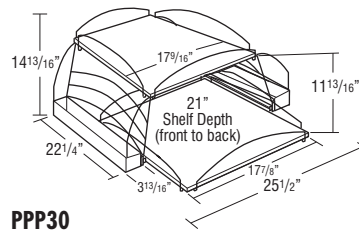

**PPP30**

- For use in 30" wide cabinets.

**PPP30**

DESCRIPTION

MODEL

**POWERGLIDE™ COMPACT DRAWER OUTLET**

**DRWPWR1**

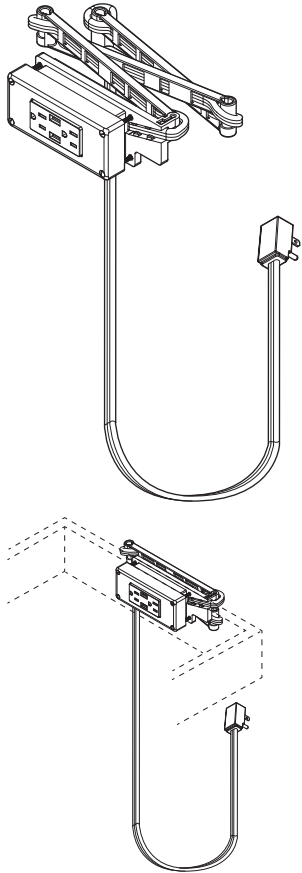

- Outlet has a total rated capacity of 15 amps.
- Includes two 120V electrical plug-ins and two 2.1 amp rated USB charging ports.
- Cord has 3 ft. of length hanging freely from back mounting bracket. The cord is 14 gauge wire and features a standard 3-prong plug and is required to be plugged into an approved AFCI/GFCI dual function outlet for all applications.
- Outlet is ETL approved-compliant for electrical and other safety standards to U.S. and Canadian safety including UL standards.
- Requires field installation including a 4.25" x 2.13" square hole to be cut into the back of the drawer box.
- Outlet face plate measures 5.22" x 2.3" and will extend 3/4" into drawer box.
- A minimum drawer box height of 2 5/8" is required for installation.
- For use in base cabinet widths of 18" to 36".
- For use in cabinet depths of 15", 18", 21", and 24".
- Also available as an installed modification, see DRWPWR on page 52.

**POWER POD**

**JPWRPODBK (Black)**

**JPWRPODSS (Stainless Steel)**

**JPWRPODGM (Gun Metal Black)**

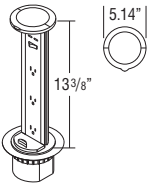

- Includes: independent power switch, three electrical sockets, and two USB ports (located above power switch).
- 18" of clearance required below surface mount location; and 3 9/16" diameter hole is required in countertop to install.
- This item requires field installation. This accessory cannot be installed above drawers.
- Safe for countertop installation: rated IP54-splash proof from splashing water and water jets per IPX waterproof specifications; and is ETL approved-compliant for electrical and other safety standards to North America safety including: UL, ANSI, CSA, ASTM, and NFPA standards.
- When installed, top lip of strip sits on top of countertop with a pivoting handle. Handle is pulled up to bring bottom of power strip to countertop.
- Cord is 8 ft. long and features a standard 3-prong plug for use in any household outlet. 10 amps.

DESCRIPTION

MODEL

**SLIDING TOWEL RACK**



**STR**

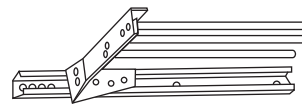

- Metal.
- 5" wide x 17 3/4" long x 1 1/2" high.
- Fits in any sink cabinet.

**EZ-ORG™ MODULAR PULL-OUT RACKS**



**EZORG18  
EZORG24**

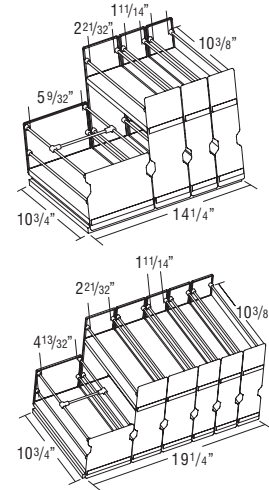

- EZORG18 includes four pull-out racks installed onto a wood base for use in an 18" wide or wider cabinet. Outside rack dimensions: one 5 7/8" wide x 5 3/4" high one 3 1/4" wide x 10 3/4" high two 2 3/8" wide x 10 3/8" high
- EZORG24 includes six pull-out racks installed onto a wood base for use in a 24" wide or wider cabinet. Outside rack dimensions: one 5" wide x 5 3/8" high two 3 1/4" wide x 10 3/4" high three 2 3/8" wide x 10 3/8" high
- Entire pull-out must be installed as one unit, cannot remove racks from wood base for individual installation.
- Racks feature natural finish wood shelves with wire racks and frosted front and back panels. Guides are full extension and do not feature smart close.
- Maximum Weight Capacity: 2 3/8" and 3 1/4" wide racks: 7 lbs. 5" and 5 7/8" wide racks: 20 lbs.
- Must be installed on the floor of the cabinet. Cannot be installed on an adjustable shelf.
- Field installation requires attaching wood base to cabinet bottom with pre-drilled mounting holes, includes 4 screws and instructions.
- Installation height clearance of 12" minimum is recommended.

**SPICE RACKS**



**SRCH12**

**SRCH15**

**SRCH18**

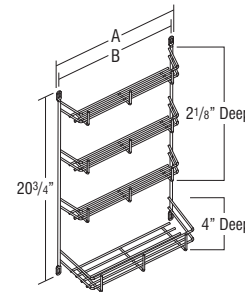

Model	A	B	Fits
SRCH12	7 7/8"	8 13/50"	B15, B30, B33
SRCH15	10 5/8"	11"	B18, B36
SRCH18	13 5/8"	14"	B21, B24 L or R

- A = Hole Centers Width**
- B = Outside Overall Widths**
- Designed for Base cabinets only. Mounts to door top and bottom rails.
- Spice Rack is chrome.

**SPICE RACK PULL-DOWN**



**SPD18**



- Spice Rack Pull-down dimensions: 8 15/16" high x 14 13/16" wide x 10 5/16" deep.
- Extends 3 3/4" below and 9 1/4" in front of the cabinet box when fully extended.
- Maximum Weight Capacity: 15 lbs.
- Must be installed on the floor of the cabinet. Cannot be installed on an adjustable shelf.

**SHELF PULL-DOWN**



**SHLFPD36**

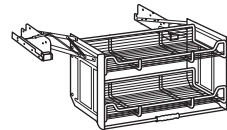

- Shelf Pull-down dimensions: 18 11/64" high x 28 1/4" wide x 8 1/2" deep.
- Clearance dimensions: 19 3/8" high x 15 3/8" wide.
- Maximum Weight Capacity: 26 lbs.
- Must be installed on the floor of the cabinet. Cannot be installed on an adjustable shelf.

**DESCRIPTION**

**MODEL**

**TOEKICK VACUUM**



**TOEKICKVAC**

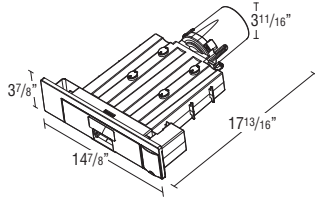

- 120V compact vacuum cleaner for field installation into the toekick area of base cabinets. Toekick area must be routed for vacuum to be inserted and screwed into place.
- Flooring installation must be compatible with the vacuum by ensuring the bottom of the cabinet is flush with the top of the flooring to allow clearance for the tray to open to access the bag and filter. The flooring should either be installed under the cabinets or the cabinets can be raised to the flooring level.
- Vacuum is 120V-60Hz, rated current of 5 amps, and rated input power is 650W.
- Cord is 10 ft. from the right side of the unit and features a standard 3-prong plug for use in any household outlet.
- Built-in switch can be gently tapped to turn the unit on and off.
- Should not be installed in a sink base, bathroom, outdoors, or in other wet environments. Do not expose to moisture, rain, or snow. Do not pick up water or sweep water into the vacuum.
- For installation in the front toekick, cabinet must have a minimum depth of 22" and a minimum width of 18". For installation in an end panel, cabinet must have a minimum depth of 21" and a minimum width of 21".
- TOEKICKVAC includes three reusable 0.5 gallon vacuum bags and one HEPA filter.
- Plastic faceplate features a stainless steel look.
- An air exhaust opening equal to 8" sq (50 cm sq) is required in an area adjacent to the TOEKICKVAC at the rear or side of the cabinet, where cabinets are tight to the floor.

**TILT-OUT TRAYS, PLASTIC**



**TOT15  
TOT18**

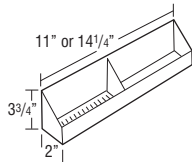

- Kit includes two white plastic trays and one pair of tilt-out hinges that attaches to the inside of the false panel.
- One tilt-out tray per false panel on cabinets less than 30" wide and greater than 36" wide, two tilt-out trays attached to one false panel on 30"-36" wide cabinets.
- Clean using a mild soap and water. Avoid scalding water.

Model	Width	Application
TOT15	11"	SB30, SB33
TOT18	14 1/4"	SB36, SB39, SB42, SB24, SB27, SB48

**DESCRIPTION**

**MODEL**

**TILT-OUT TRAYS, STAINLESS STEEL SLIM**



**TOTSSS10  
TOTSSS13  
TOTSSS16  
TOTSSS19  
TOTSSS25  
TOTSSS31**

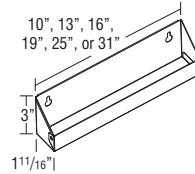

- Contains one tray and one pair of tilt-out hinges that attaches to the inside of the false panel.
- One tilt-out tray per false panel.
- Tray is 1 11/16" deep and protrudes 3/4" into cabinet.

Model	Width	Application
TOTSSS10	10"	ACS36, VSB15
TOTSSS13	13"	SB39, ACS39, VSB18, VSB39, 2VSD36, 2VSD42, 2VSD48, VSD60, 6VSD42FP
TOTSSS16	16"	SB21, SB42, SB45, VSB21, VSB42, VSB45, 2VSD45, VSD54FP, VSD60FP, VSDS54, VSDS57, VSDS60, 6VSD45
TOTSSS19	19"	SB24, SB27, SB48, ACS42, VSB24, VSB27, VSB48, VSB54, 2VSD54, 2VSD60, VSD24FP, VSD27FP, 6VSD48FP, 6VSD54FP, 6VSD57FP, 6VSD60FP, 8VSD48FP, 8VSD60FP
TOTSSS25	25"	SB30, SB33, VSB30, VSB33, VSB60, VSD30FP, VSD33FP, VSD42FP, VSD45FP, VSWD30FP
TOTSSS31	31"	SB36, VSB36, VSD36FP, VSD48FP, VSWD36FP

**TRAY DIVIDER, CHROME**



**CTDK**

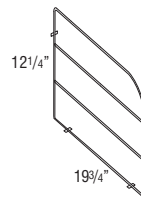

- CTDK: Includes 1 divider, 3 clips, and 3 screws.
- Tray divider is chrome wire.

**TRAY DIVIDER KIT**



**TDKIT15  
TDKIT18  
TDKIT21  
TDKIT24  
TDKIT27**

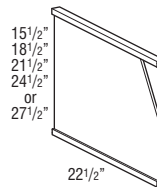

- Cabinets need full top and bottom for field installation of tray divider kits.
- Dividers are sized for a 24" deep cabinet, depth can be modified during field installation. Installation screws included.
- Tray dividers are Natural Maple laminated plywood. When specified with WLI, dividers are white laminated plywood. Rails are always Natural Maple.

Model	Application	Wall Cabinets	Tall Cabinets – Upper Section
TDKIT15	Fits 15" high frame opening	Most 18" high wall cabinets	Upper section of 84" high utility, oven cabinets with 15" high frame opening
TDKIT18	Fits 18" high frame opening	Most 21" high wall cabinets	Upper section of 87" high utility, oven cabinets with 18" high frame opening
TDKIT21	Fits 21" high frame opening	Most 24" high wall cabinets	Upper section of 90" high utility, oven cabinets with 21" high frame opening
TDKIT24	Fits 24" high frame opening	Most 27" high wall cabinets	Upper section of 93" high utility, oven cabinets with 24" high frame opening
TDKIT27	Fits 27" high frame opening	Most 30" high wall cabinets	Upper section of 96" high utility, oven cabinets with 27" high frame opening

**DESCRIPTION**

**MODEL**

**TRAY DIVIDER ROLL-OUT KIT**



**TDRO12**  
**TDRO15**

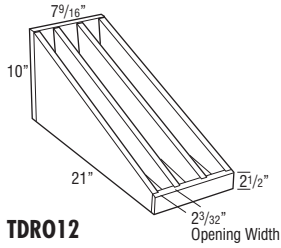

- TDRO12: 2 removable dividers (3 compartments).
- TDRO15: 3 removable dividers (4 compartments).
- Utilizes smart close undermount guides.
- Installation hardware included.

**TDRO12**

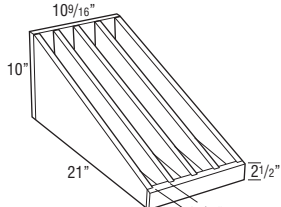

**TDRO15**

**VANITY CHROME ROLL-OUT RACK**



**VCRR1521**  
**VCRR1821**

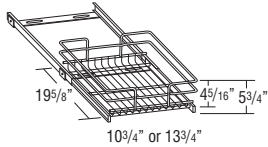

- VCRR1521 requires installation to a fixed shelf or cabinet bottom in a minimum 21" deep cabinet with a minimum frame opening of 12".
- VCRR1521 installed dimensions: 19 3/4" deep x 11" wide x 5 3/4" high.
- VCRR1821 requires installation to a fixed shelf or cabinet bottom in a minimum 21" deep cabinet with a minimum frame opening of 15".
- VCRR1821 installed dimensions: 19 3/4" deep x 14" wide x 5 3/4" high.
- Roll-out rack is full extension.
- See chart for recommended cabinet list, requires sufficient field plumbing clearance.

Model	Applicable Cabinet Width	
	VCRR15	VCRR18
DDO_2921	15"	18"
L188421BH		18" (upper section)
LCT88421		18" (lower section)
LT188421		18"
LTD188421, LTD188421BH		18"
2VSD_21	54" (side doors)	36", 60" (side doors)
6VSD_21, 6VSD_21FP		42"
V_21	15"	18"
VB_21	15", 30"	18", 36"
VSBD_21	15", 30"	18", 36"
VSD_21	27"	30"
VSWD_21FP	30"	36"
VU188421		18"

**DESCRIPTION**

**MODEL**

**VANITY WASTEBASKET KIT**



**VWB**

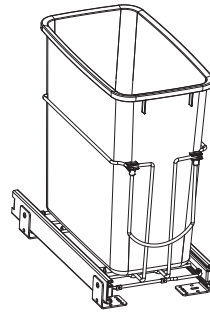

- Bottom mount zinc colored smart close guide with 20 quart gray wastebasket inserted in chrome support.
- Dimension of insert: 8 37/64"W x 16 39/64"H x 17 3/4"D.

**WALL SUSAN KITS**



**WSK30**

**WSK33**

**WSK36**

**WSK39**

**WSK42**

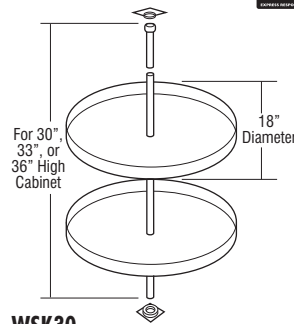

- 30"-36" kits include pole and two 18" diameter plywood shelves. 39" and 42" kits include pole and three 18" diameter plywood shelves.

**WSK30**

**WSK33**

**WSK36**

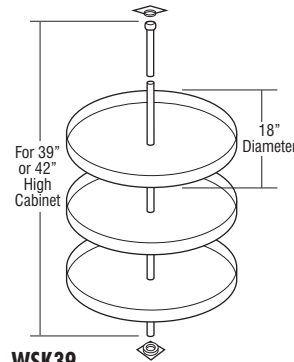

**WSK39**

**WSK42**

**WINE GLASS HOLDERS**

**WGH30** (7 slots)

**WGH33** (7 slots)

**WGH36** (8 slots)

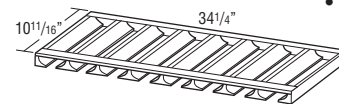
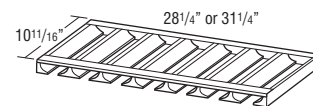

- Maximum wine glass base is 3" diameter.
- Wine Glass Holder is finished.
- May be trimmed to fit smaller cabinets.
- Designed for installation under a wall cabinet (between end panels and behind face frame).

**Species Availability (Wood)**

	Rustic Alder	Cherry	Rustic Hickory	Maple	Oak
•	•	•	•	•	•

**Species Availability (All Laminates)**

	Horiz. Grain on Maple	Vert. Grain on Maple	Vert. Grain on Cherry	Vert. Grain on Oak
High Gloss box color	•	•	•	•

**DESCRIPTION**

**MODEL**

**ROLL TRAY KITS**

**ROLL TRAY KIT**

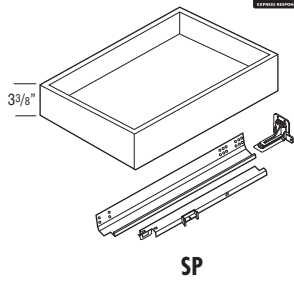

For 18" Deep Cabinets

- RT1218SP
- RT1518SP
- RT1818SP
- RT2118SP
- RT2418SP
- RT2718SP
- RT3018SP
- RT3318SP
- RT3618SP
- RT3918SP
- RT4218SP
- RT4518SP
- RT4818SP

For 21" Deep Cabinets

- RT1221SP
- RT1521SP
- RT1821SP
- RT2121SP
- RT2421SP
- RT2721SP
- RT3021SP
- RT3321SP
- RT3621SP
- RT3921SP
- RT4221SP
- RT4521SP
- RT4821SP

For 24" Deep Cabinets

- RT12SP
- RT15SP
- RT18SP
- RT21SP
- RT24SP
- RT27SP
- RT30SP
- RT33SP
- RT36SP
- RT39SP
- RT42SP
- RT45SP
- RT48SP

- RT\_\_SP's include roll tray, roll tray brackets, hardware, screws, and installation instructions.
- 39"-48" wide Roll Tray Kits will contain 1 roll tray. QTY of 2 must be ordered to achieve a roll tray in both cabinet openings.

**Custom Modifications**

ID	RD
	•

**DESCRIPTION**

**MODEL**

**DEEP ROLL TRAY KIT**

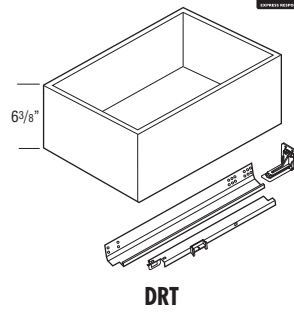

For 18" Deep Cabinets

- DRT1218
- DRT1518
- DRT1818
- DRT2118
- DRT2418
- DRT2718
- DRT3018
- DRT3318
- DRT3618
- DRT3918
- DRT4218
- DRT4518
- DRT4818

For 21" Deep Cabinets

- DRT1221
- DRT1521
- DRT1821
- DRT2121
- DRT2421
- DRT2721
- DRT3021
- DRT3321
- DRT3621
- DRT3921
- DRT4221
- DRT4521
- DRT4821

For 24" Deep Cabinets

- DRT12
- DRT15
- DRT18
- DRT21
- DRT24
- DRT27
- DRT30
- DRT33
- DRT36
- DRT39
- DRT42
- DRT45
- DRT48

- DRT\_\_'s include deep roll tray, deep roll tray brackets, hardware, screws, and installation instructions.
- 39"-48" wide Deep Roll Tray Kits will contain 1 roll tray. QTY of 2 must be ordered to achieve a roll tray in both cabinet openings.

**Custom Modifications**

ID	RD
	•

**DESCRIPTION**

**MODEL**

**ROLL TRAY KIT – EASYTRAX™**

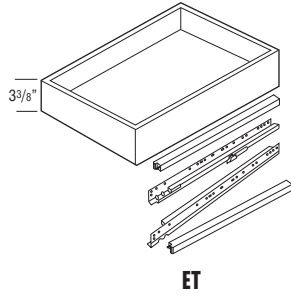

For 18" Deep Cabinets

- RT1518ET
- RT1818ET
- RT2118ET
- RT2418ET
- RT2718ET
- RT3018ET
- RT3318ET
- RT3618ET
- RT3918ET
- RT4218ET
- RT4518ET
- RT4818ET

For 21" Deep Cabinets

- RT1521ET
- RT1821ET
- RT2121ET
- RT2421ET
- RT2721ET
- RT3021ET
- RT3321ET
- RT3621ET
- RT3921ET
- RT4221ET
- RT4521ET
- RT4821ET

For 24" Deep Cabinets

- RT15ET
- RT18ET
- RT21ET
- RT24ET
- RT27ET
- RT30ET
- RT33ET
- RT36ET
- RT39ET
- RT42ET
- RT45ET
- RT48ET

- EasyTrax™ uprights are required, must be purchased separately (see page 379).
- RT-ET's contain roll tray, hardware, wooden hardware mounting bracket, screws and installation instructions.
- 39"-48" wide Roll Tray Kits will contain 1 roll tray. QTY of 2 must be ordered to achieve a roll tray in both cabinet openings.

**Custom Modifications**

ID	RD
	•

**DESCRIPTION**

**MODEL**

**DEEP ROLL TRAY KIT – EASYTRAX™**

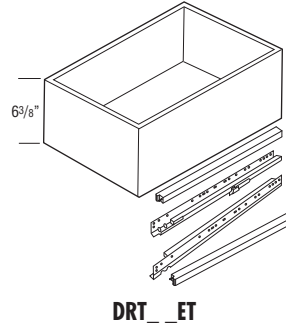

For 18" Deep Cabinets

- DRT1218ET
- DRT1518ET
- DRT1818ET
- DRT2118ET
- DRT2418ET
- DRT2718ET
- DRT3018ET
- DRT3318ET
- DRT3618ET
- DRT3918ET
- DRT4218ET
- DRT4518ET
- DRT4818ET

For 21" Deep Cabinets

- DRT1221ET
- DRT1521ET
- DRT1821ET
- DRT2121ET
- DRT2421ET
- DRT2721ET
- DRT3021ET
- DRT3321ET
- DRT3621ET
- DRT3921ET
- DRT4221ET
- DRT4521ET
- DRT4821ET

For 24" Deep Cabinets

- DRT12ET
- DRT15ET
- DRT18ET
- DRT21ET
- DRT24ET
- DRT27ET
- DRT30ET
- DRT33ET
- DRT36ET
- DRT39ET
- DRT42ET
- DRT45ET
- DRT48ET

- EasyTrax™ uprights are required, must be purchased separately (see page 379).
- DRT-ET's contain roll tray, hardware, wooden hardware mounting bracket, screws and installation instructions.
- 39"-48" wide Deep Roll Tray Kits will contain 1 roll tray. QTY of 2 must be ordered to achieve a roll tray in both cabinet openings.

**Custom Modifications**

ID	RD
	•



**DESCRIPTION**

**MODEL**

**EASYTRAX™ UPRIGHTS**

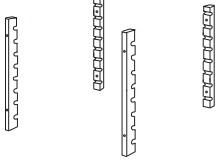

**ETUPRIGHT**

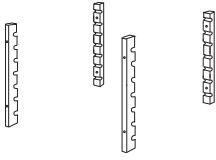

**ETUPRIGHTOV**

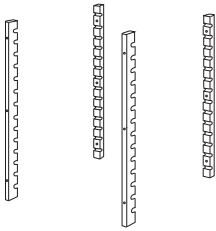

**ETUPRIGHT40.5**

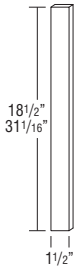

**ETUPRCS  
ETUPR40.5CS**

**ETUPRIGHT**

**ETUPRIGHTOV**

**ETUPRIGHT40.5**

**ETUPRCS**

**ETUPR40.5CS**

- EasyTrax™ system allows quick field installation of adjustable height roll trays with front and rear uprights to support roll tray guides.
- ETUPRIGHT contains 2 front and 2 rear uprights.  
QTY required: Base, Base Full Height, and 34 1/2" high Vanities = 1  
Utility Cabinets = 3  
42" and 48" wide cabinets = 2.
- ETUPRIGHTOV contains 2 front and 2 rear uprights.  
QTY required: Desk and 32" high Vanity = 1.
- ETUPRIGHT40.5 contains 2 front and 2 rear uprights.  
QTY required: 40 1/2" high Base cabinets = 1.
- ETUPRCS and ETUPR40.5CS recommended for DRT39ET-DRT48ET kits to secure drawer guide in ET system on cabinets with center stiles.

**DESCRIPTION**  
**GUIDE KITS AND PARTS**

**MODEL**

**DRAWER GUIDE KITS**

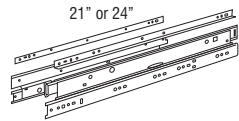

**DGK\_\_DDFX**

**DGK21DDFX**  
**DGK24DDFX**

- Side-mount progressive full extension guide utilized on all drawers of DDFD cabinets.
- Maximum Weight Capacity: 125 lbs. per pair.
- Kit includes guide hardware for one drawer box (cabinets, drawer members wood vertical mounting rails and screws) Dimension refers to cabinet depth.

12", 15", 18", 21", or 24"

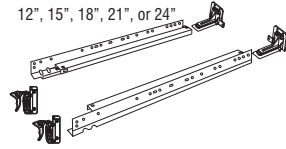

**DGKIT\_\_PG**

**DGKIT12PG**  
**DGKIT15PG**  
**DGKIT18PG**  
**DGKIT21PG**  
**DGKIT24PG**

- Undermount full extension smart close Premium Guide (PG).
- Maximum Weight Capacity: 90 lbs. per pair.
- Kit includes guide hardware for one drawer box (cabinets and drawer members, sockets and screws) Dimension refers to cabinet depth.

12", 15", 18", 21", or 24"

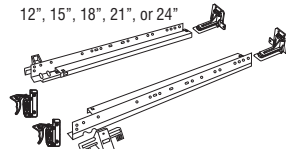

**DGKIT\_\_RTSP**

**DGKIT12RTSP**  
**DGKIT15RTSP**  
**DGKIT18RTSP**  
**DGKIT21RTSP**  
**DGKIT24RTSP**

- Undermount full extension smart close Premium Guide utilized on roll trays.
- Maximum Weight Capacity: 90 lbs. per pair.
- Kit includes guide hardware for one drawer box (cabinets and drawer members, sockets and screws) Dimension refers to cabinet depth.

**DRAWER GUIDE BACK SOCKETS**



**BKSOCKET-PG**  
**BKSOCKET-SP**

- BKSOCKET-PG used with smart close drawer guides (12"-24" deep).
- BKSOCKET-SP used with smart close roll tray guides.
- Sold in pairs.

**NEW** **DRAWER GUIDE BOX LOCKS**



**DGBOXLOCK**  
**DGBOXLOCKB9**

- DGBOXLOCK used with smart close drawer guides.
- DGBOXLOCKB9 used with smart close drawer guides on cabinets with drawers with a face frame opening of 7 1/2" or less.
- Sold in pairs.

**DRAWER GUIDE SPACER BLOCK**



**SPACERBLK**

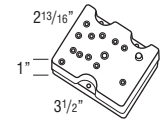

- Sold in pairs.
- For use with DGKIT..PG and DGKIT..SP kits when RD is used for depths other than in 3" increments.
- One SPACERBLK required for each inch of depth.
- Not required for use with 23", 20", 17", 14" depth.

**FALSE PANEL CLIPS**



**FALSEPNLCLIP50**  
**PFALSEPNLCLIP50**

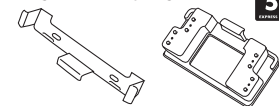

- Use to secure false front on sink base.
- Sold in pairs.

**DESCRIPTION**

**MODEL**

**ROLL TRAY PLUG IN BRACKET**



**RTBKSXSP**

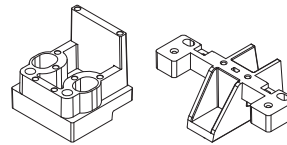

- For use with roll tray hardware to prevent interference with door hinges. Also included in roll tray hardware kit.
- Includes four end panel brackets, two vertical stile brackets, and screws.

**DESCRIPTION****MODEL****STAIN, PAINT, & TOUCH-UP TOOLS****STAIN & PAINT****QUARTCOLOR****SSC****SSCCLEAR****SSCMATTESH**

- Wiping stains can be sprayed at low pressure.
- Specify finish name and wood type when ordering.
- QUARTCOLOR sold in quarts.
- SSC is a 384 mL aerosol can available in Paint colors.
- SSCCLEAR is a 384 mL aerosol can in clear.
- SSCMATTESH is a 384 mL aerosol can in clear with a matte sheen.
- QUARTCOLOR and SSC will match the cabinet box color when ordered in High Gloss Laminate AF, High Gloss Laminate AG, Laminate AH, Laminate AI, Laminate AJ, Laminate AK, Laminate AL, Laminate AM, and Laminate AN.
- For Touch-up Kits and Glaze Pens, see below.

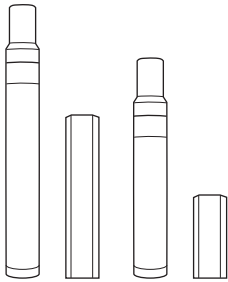
**TOUCH-UP TOOLS****TUK****MTUK****GLAZEPEN****TUK****MTUK**

- Touch-up Kit includes a full size touch-up marker and an 8 cm fill stick. A small glaze pen is also included when ordered with glaze finishes.
- Mini Touch-up Kit includes a small touch-up marker and a 4 cm fill stick. No glaze pen included with glaze finishes.
- GLAZEPEN available in glaze colors only.
- GLAZEPEN works on finished doors and does not require a separate top coat.

**CABINET CARE KIT (PURE&SIMPLE™)****CABCLEANKIT**

- PURE&SIMPLE™ Cabinet Care Kit includes one 16 ounce spray bottle of cleaning solution and a small microfiber cloth.
- Safe for use on wood and laminate cabinet surfaces.



**DESCRIPTION**

**MODEL**

**HINGES**

**HINGES**

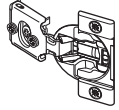

**38NPOHINGE**

- Integrated smart close.
- 6-way adjustable.
- 1/2" partial overlay 107° hinge.
- For use on Base Transition Cabinets (BTC), Diagonal Wall (DW) and Diagonal Base (DAB) Cabinets, 36" Angled Corner Sink Bases (ACS) & Fronts (ACSF), and Wall Top Hinge (WTH) Cabinets with Modified Full Overlay (MFO).
- Sold in pairs.

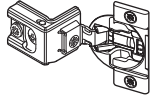

**38CFOHINGE**

- Integrated smart close.
- 6-way adjustable.
- 107° full overlay hinge.
- For use on all full overlay cabinets not specified by other hinges.
- Sold in pairs.

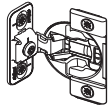

**38BFOVHINGE**

- Integrated smart close.
- 4-way adjustable.
- Face-mount 107° full overlay hinge.
- For use on oven cabinets with 3" wide face frames (OSB, OCD, OMC, OCS, and TBMWB), and 36"-42" high WBMW cabinets.
- Sold in pairs.

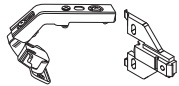

**32049HINGE**

- 90° Corner Self-Closing Center Hinge.
- For use on ER, BLS, SLS, BER, BERAS, and CS cabinets.
- Sold in pairs.



**942HINGE**

- 170° Hinge
- For use on BSC, BLS, SLS, BER, BERAS, CS, and ER cabinets.
- Sold in pairs.



**7299HINGE**

- Mirror Hinge
- For use on TV and MC cabinets.
- Sold in pairs.

**HINGE ANGLE RESTRICTION CLIP**



**HINGERESCLIP**

- For use in applications with cabinets installed at varying depths to prevent the door damage caused by opening into an adjacent cabinet.
- Restricts hinges to 86° opening capability.
- Works only with the 38NPOHINGE and 38CFOHINGE.
- Sold in pairs.

**DESCRIPTION**

**MODEL**

**HINGE SHIM**



**HINGESHIMS**

- Install between the face frame and hinge to allow additional adjustment of doors. Can be used to reduce gap between butt doors.
- Each shim is 1/32" thick and can be stacked to achieve desired overlay reduction.
- Pack of 5 metal shims.
- Compatible with all hinges except face-mount.

**LIDSTAY**

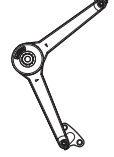

**LIDSTAY**

- Sold in pairs.
- Recommended for field installed wall top hinge applications 12" to 18" high.

**LIDSTAY - HEAVY DUTY**



**LIDSTAYHD**

- One heavy duty lid stay hinge required per cabinet.
- Recommended for field installed wall top hinge applications of 21" high cabinets.

**WALL TOP HINGE ANGLE RESTRICTION CLIPS**



**WTHRESCLIP75**

- For use on 9" high Wall Top Hinge cabinets only.
- Restricts opening angle of the door to 75°.
- Prevents the door from hitting the ceiling or an object above, also keeps the handle within reach on very high cabinets.
- Sold in pairs (two clips required per cabinet).

**DESCRIPTION**

**MODEL**

**DOORS, DRAWER FRONTS, & DRAWERS**

**DOORS & DRAWER FRONTS**



Standard Door Size, 18" High or Less  
 Standard Door Size, 21" to 30" High  
 Standard Door Size, 33" or Higher  
 Standard Door Size, No Hinge Route, 18" High or Less  
 Standard Door Size, No Hinge Route, 21" to 30" High  
 Standard Door Size, No Hinge Route, 33" or Higher

**Any Drawer Front Only**

- Door heights are based on full overlay for equivalent applications.
- All applicable modification and premium finish upcharges will apply.
- Backs of "NO HINGE ROUTE" doors may have identification marks, be unfinished, and have 3/16" diameter holes used during finish processing. For these reasons, these doors are not suitable for use as cabinet doors.

**DRAWERS**



**Complete Drawer  
 Drawer Box Only**

- All applicable modification and premium finish upcharges will apply.
- Complete Drawer and Drawer Box Only do not include drawer guides. They must be ordered separately.

**DESCRIPTION**

**MODEL**

**PARTS**

**MISCELLANEOUS PARTS**

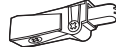

**PDM**

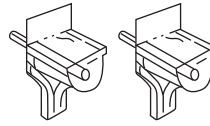

**SHELFPEGS**

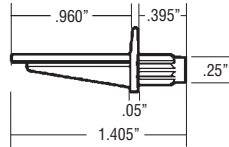

**SHELFPEGSCTR**



**BRKOFFSCREW** (pkg. 25)  
**BUMPERPADS** (pkg. 25)  
**INSTALLSCR4** (pkg. 4)  
**INSTALLSCREWS** (pkg. 100)

**PDM**

**RETCLIP250BAG**

**SHELFPEGS** (pkg. 24)

**SHELFPEGSCTR** (pkg. 6)

- BRKOFFSCREW is a pack of 25 breakaway screws for use with decorative hardware pulls and knobs.
- INSTALLSCR4 and INSTALLSCREWS are screws for cabinet installation through the cabinet back to the wall studs (includes a pack of 4 or 100).
- PDM creates a smooth and silent self-closing motion and includes all installation hardware.
- RETCLIP250BAG: 6 retainer clips for use with glass inserts in mullion and cut-for-glass doors.
- SHELFPEGS are 3mm steel pins with clear plastic shoulders.
- SHELFPEGSCTR is a package of 6 clear plastic shelf clips with 0.96" usable depth with 1/4" diameter pegs used on center mullions of full depth shelves (cabinets 39"-48" wide), BC\_, BEC24, BFH\_\_CIA, BFH\_\_COA, W\_\_CIA, WC\_\_, WEC\_\_D, and cabinets specified with FFD\_\_ with adjustable shelves.

**DESCRIPTION**

**MODEL**

**STACK MOULDING KITS**

- Moulding stacks do not ship assembled; field assembly is required. Assembly instructions can be viewed in 20/20 spec pages and will also ship with moulding kits.
- When ordered as a kit, only one finish can be specified. To order with more than one finish, moulding pieces must be ordered separately.
- Moulding stacks include Assembly Instructions. Cleats and finish nails not included.

- How to place a stack moulding in 20/20:
  - Moulding
  - Top Mouldings or Bottom Mouldings
  - Stacked Mouldings
  - Drag and drop desired moulding stack onto wall cabinets
- Mouldings specified as 8' nominal length have a usable length range of 93" up to 99". Mouldings specified as 10' nominal length have a usable length range of 117" up to 123". Be sure to order the correct amount of moulding length to work around required cuts with minimal butt joints.

384

**MOULDING STACK 1**

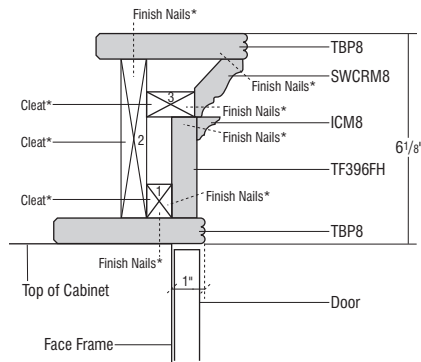
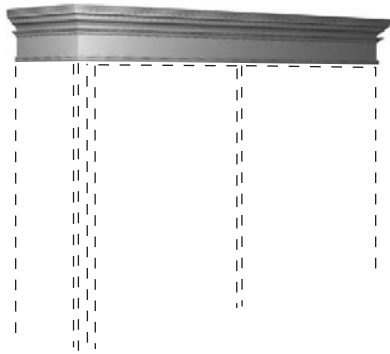

\*Cleats and finish nails not included.



**STKMLD1**

- Not recommended for use when taking application to the ceiling.

**Finish Techniques**

	Distressing	Heirlooming
TBP8		•
SWCRM8	•	•
ICM8		
TF396FH	•	

**Species Availability (Wood)**

	Alder	Rustic Alder	Cherry	Rustic Hickory	Maple	Oak
TBP8	•	Alder	•	Hickory	•	•
SWCRM8	•	Alder	•	Hickory	•	•
ICM8	•	Alder	•	Hickory	•	•
TF396FH	•	Alder	•	Hickory	•	•

**Species Availability (All Laminates)**

	High Gloss	Horiz. Grain on Maple	Vert. Grain on Maple	Vert. Grain on Cherry	Vert. Grain on Oak
TBP8	box color	box color	box color	box color	box color
SWCRM8	box color	box color	box color	box color	box color
ICM8	box color	box color	box color	box color	box color
TF396FH	box color	box color	box color	box color	box color

**MOULDING STACK 2**

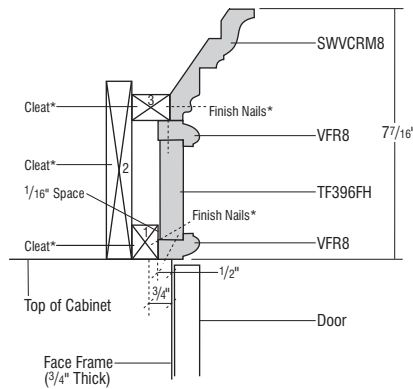
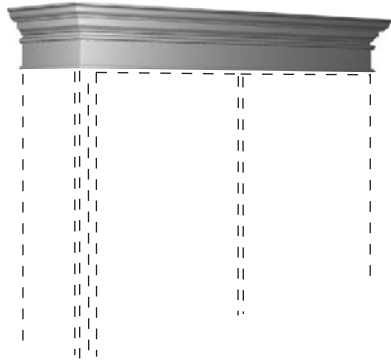

\*Cleats and finish nails not included.



**STKMLD2**

- Not recommended for use when taking application to the ceiling.

**Finish Techniques**

	Distressing	Heirlooming
SWVCRM8	•	•
VFR8		•
TF396FH	•	

**Species Availability (Wood)**

	Alder	Rustic Alder	Cherry	Rustic Hickory	Maple	Oak
SWVCRM8	•	Alder	•	Hickory	•	•
VFR8	•	Alder	•	Hickory	•	•
TF396FH	•	Alder	•	Hickory	•	•

**Species Availability (All Laminates)**

	High Gloss	Horiz. Grain on Maple	Vert. Grain on Maple	Vert. Grain on Cherry	Vert. Grain on Oak
SWVCRM8	box color	box color	box color	box color	box color
VFR8	box color	box color	box color	box color	box color
TF396FH	box color	box color	box color	box color	box color

**DESCRIPTION**

**MOULDING STACK 3**

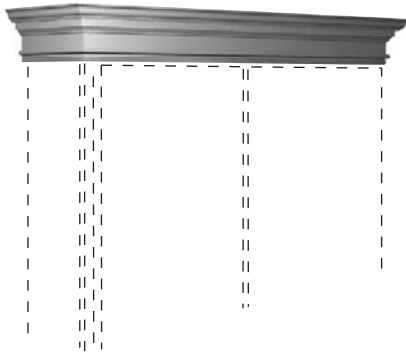

\*Cleats and finish nails not included.

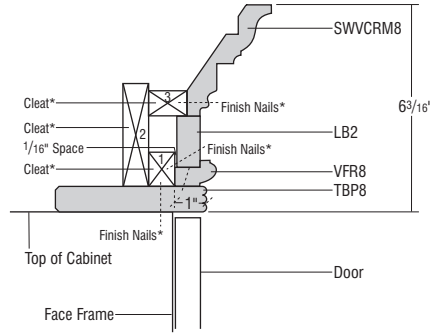

**MODEL**



**STKMLD3**

- Not recommended for use when taking application to the ceiling.

**Finish Techniques**

	Distressing	Heirlooming
SWVCRM8	•	•
LB2		
VFR8		•
TBP8		•

**Species Availability (Wood)**

	Alder	Rustic Alder	Cherry	Rustic Hickory	Maple	Oak
SWVCRM8	•	•	•	•	•	•
LB2	•	Alder	•	Hickory	•	•
VFR8	•	Alder	•	Hickory	•	•
TBP8	•	Alder	•	Hickory	•	•

**Species Availability (All Laminates)**

	High Gloss	Horiz. Grain on Maple	Vert. Grain on Maple	Vert. Grain on Cherry	Vert. Grain on Oak
SWVCRM8	box color	box color	box color	box color	box color
LB2	box color	box color	box color	box color	box color
VFR8	box color	box color	box color	box color	box color
TBP8	box color	box color	box color	box color	box color

**385**

**MOULDING STACK 5**

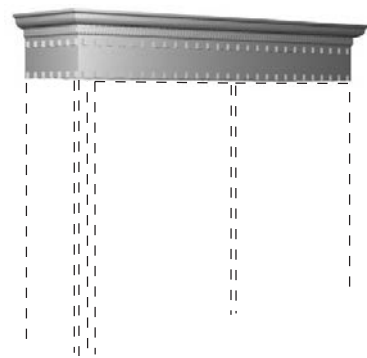

\*Cleats and finish nails not included.

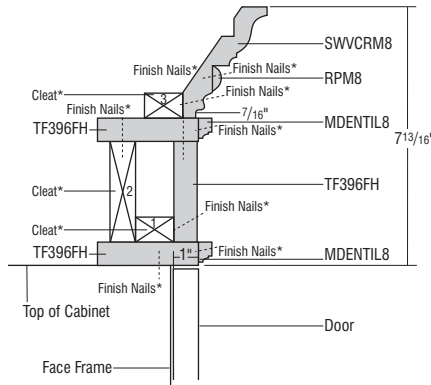

**STKMLD5**

- Not recommended for use when taking application to the ceiling.

**Finish Techniques**

	Distressing	Heirlooming
SWVCRM8	•	•
RPM8		
MDENTIL8		
TF396FH	•	

**Species Availability (Wood)**

	Alder	Rustic Alder	Cherry	Rustic Hickory	Maple	Oak
SWVCRM8	•	Alder	•		•	•
RPM8	•	Alder	•		•	•
MDENTIL8	•	Alder	•		•	•
TF396FH	•	Alder	•		•	•

**Species Availability (All Laminates)**

	High Gloss	Horiz. Grain on Maple	Vert. Grain on Maple	Vert. Grain on Cherry	Vert. Grain on Oak
SWVCRM8	box color	box color	box color	box color	box color
RPM8	box color	box color	box color	box color	box color
MDENTIL8	box color	box color	box color	box color	box color
TF396FH	box color	box color	box color	box color	box color

**MOULDING STACK 6**

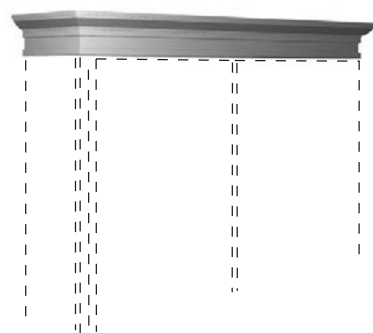

\*Cleats and finish nails not included.

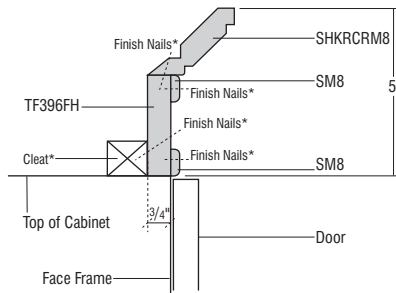

**STKMLD6**

- Not recommended for use when taking application to the ceiling.

**Finish Techniques**

	Distressing	Heirlooming
SHKRCRM8	•	•
SM8		
TF396FH	•	

**Species Availability (Wood)**

	Alder	Rustic Alder	Cherry	Rustic Hickory	Maple	Oak
SHKRCRM8	•	Alder	•	Hickory	•	•
SM8	•	Alder	•	Hickory	•	•
TF396FH	•	Alder	•	Hickory	•	•

**Species Availability (All Laminates)**

	High Gloss	Horiz. Grain on Maple	Vert. Grain on Maple	Vert. Grain on Cherry	Vert. Grain on Oak
SHKRCRM8	box color	box color	box color	box color	box color
SM8	box color	box color	box color	box color	box color
TF396FH	box color	box color	box color	box color	box color

**DESCRIPTION**

**MODEL**

**MOULDING STACK 7**

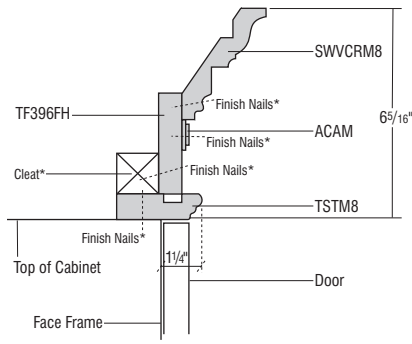
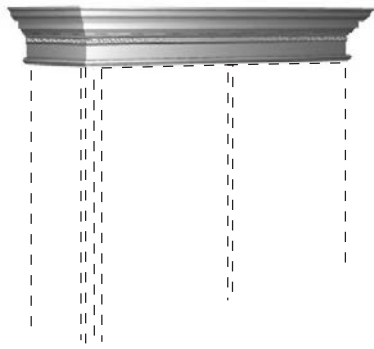

\*Cleats and finish nails not included.



**STKMLD7**

- Not recommended for use when taking application to the ceiling.

**Finish Techniques**

	Distressing	Heirlooming
SWVCRM8	•	•
ACAM		
TF396FH	•	
TSTM8		

**Species Availability (Wood)**

	Alder	Rustic Alder	Cherry	Rustic Hickory	Maple	Oak
SWVCRM8	•	Alder	•	Hickory	•	•
ACAM	•	Alder	•	Beech	•	Beech
TF396FH	•	Alder	•	Hickory	•	•
TSTM8	•	Alder	•	Hickory	•	•

**Species Availability (All Laminates)**

	High Glass	Horiz. Grain on Maple	Vert. Grain on Maple	Vert. Grain on Cherry	Vert. Grain on Oak
SWVCRM8	box color	box color	box color	box color	box color
ACAM	box color	box color	box color	box color	Beech
TF396FH	box color	box color	box color	box color	box color
TSTM8	box color	box color	box color	box color	box color

**MOULDING STACK 8**

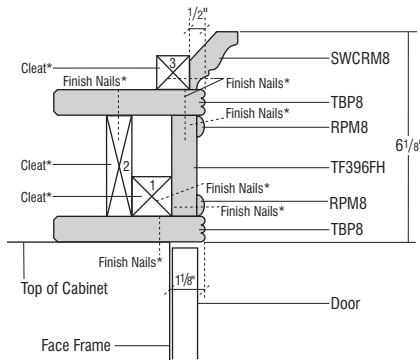
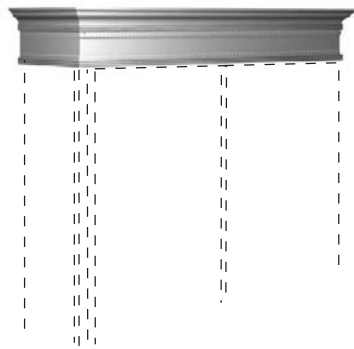

\*Cleats and finish nails not included.



**STKMLD8**

- Not recommended for use when taking application to the ceiling.

**Finish Techniques**

	Distressing	Heirlooming
SWCRM8	•	•
RPM8		
TBP8		•
TF396FH	•	

**Species Availability (Wood)**

	Alder	Rustic Alder	Cherry	Rustic Hickory	Maple	Oak
SWCRM8	•	Alder	•	Hickory	•	•
RPM8	•	Alder	•	Hickory	•	•
TBP8	•	Alder	•	Hickory	•	•
TF396FH	•	Alder	•	Hickory	•	•

**Species Availability (All Laminates)**

	High Glass	Horiz. Grain on Maple	Vert. Grain on Maple	Vert. Grain on Cherry	Vert. Grain on Oak
SWCRM8	box color	box color	box color	box color	box color
RPM8	box color	box color	box color	box color	box color
TBP8	box color	box color	box color	box color	box color
TF396FH	box color	box color	box color	box color	box color

**MOULDING STACK 10**

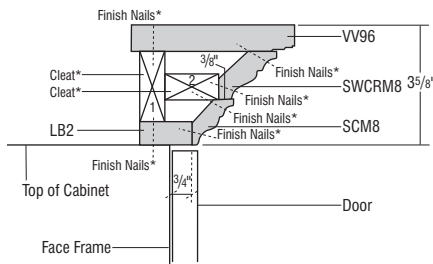
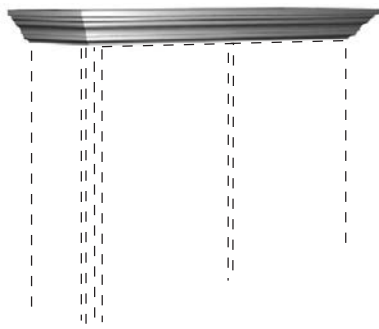

\*Cleats and finish nails not included.



**STKMLD10**

- Not recommended for use when taking application to the ceiling.

**Finish Techniques**

	Distressing	Heirlooming
VV96	•	•
SWCRM8	•	•
SCM8	•	•
LB2		

**Species Availability (Wood)**

	Alder	Rustic Alder	Cherry	Rustic Hickory	Maple	Oak
VV96	•	Alder	•	Hickory	•	•
SWCRM8	•	Alder	•	Hickory	•	•
SCM8	•	Alder	•	Hickory	•	•
LB2	•	Alder	•	Hickory	•	•

**Species Availability (All Laminates)**

	High Glass	Horiz. Grain on Maple	Vert. Grain on Maple	Vert. Grain on Cherry	Vert. Grain on Oak
VV96	box color	box color	box color	box color	box color
SWCRM8	box color	box color	box color	box color	box color
SCM8	box color	box color	box color	box color	box color
LB2	box color	box color	box color	box color	box color



**DESCRIPTION**

**MODEL**

**MOULDING STACK 11**

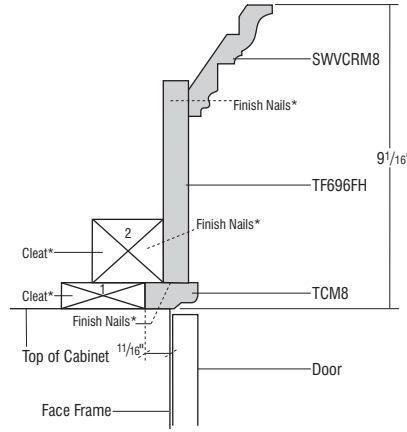
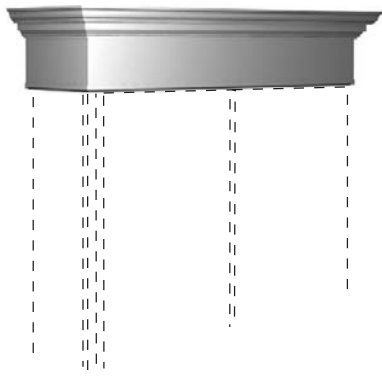

\*Cleats and finish nails not included.



**STKMLD11**

**Finish Techniques**

	Distressing	Heirlooming
SWVCRM8	•	•
TF696FH	•	
TCM8		•

**Species Availability (Wood)**

	Alder	Rustic Alder	Cherry	Rustic Hickory	Maple	Oak
SWVCRM8	•	Alder	•	Hickory	•	•
TF696FH	•	Alder	•	Hickory	•	•
TCM8	•	Alder	•	Hickory	•	•

**Species Availability (All Laminates)**

	High Gloss	Horiz. Grain on Maple	Vert. Grain on Maple	Vert. Grain on Cherry	Vert. Grain on Oak
SWVCRM8	box color	box color	box color	box color	box color
TF696FH	box color	box color	box color	box color	box color
TCM8	box color	box color	box color	box color	box color

**387**

**MOULDING STACK 13**

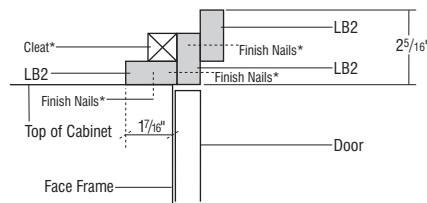
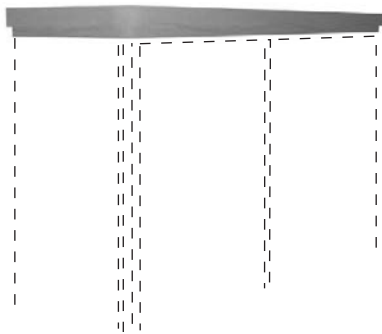

\*Cleats and finish nails not included.



**STKMLD13**

**Finish Techniques**

	Distressing	Heirlooming
LB2		

**Species Availability (Wood)**

	Alder	Rustic Alder	Cherry	Rustic Hickory	Maple	Oak
LB2	•	Alder	•	Hickory	•	•

**Species Availability (All Laminates)**

	High Gloss	Horiz. Grain on Maple	Vert. Grain on Maple	Vert. Grain on Cherry	Vert. Grain on Oak
LB2	box color	box color	box color	box color	box color

**MOULDING STACK 14**

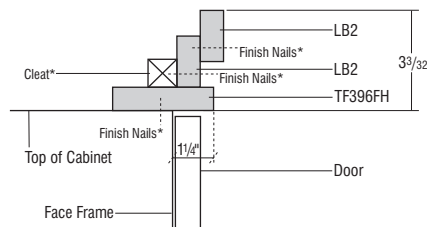
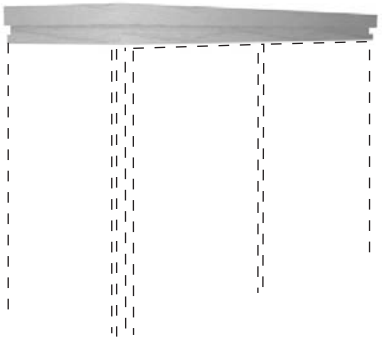

\*Cleats and finish nails not included.



**STKMLD14**

**Finish Techniques**

	Distressing	Heirlooming
LB2		
TF396FH	•	

**Species Availability (Wood)**

	Alder	Rustic Alder	Cherry	Rustic Hickory	Maple	Oak
LB2	•	Alder	•	Hickory	•	•
TF396FH	•	Alder	•	Hickory	•	•

**Species Availability (All Laminates)**

	High Gloss	Horiz. Grain on Maple	Vert. Grain on Maple	Vert. Grain on Cherry	Vert. Grain on Oak
LB2	box color	box color	box color	box color	box color
TF396FH	box color	box color	box color	box color	box color

**DESCRIPTION**

**MODEL**

**MOULDING STACK 16**

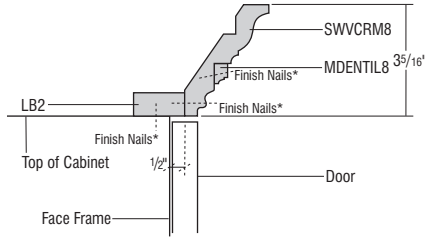
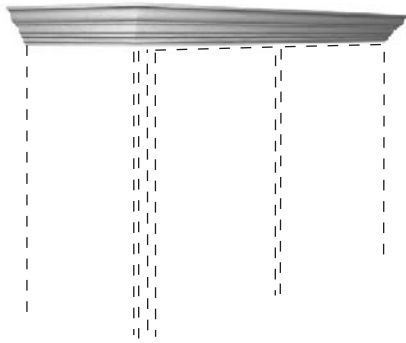

\*Cleats and finish nails not included.



**STKMLD16**

- Not recommended for use when taking application to the ceiling.

**Finish Techniques**

	Distressing	Heirlooming
SWVCRM8	•	•
MDENTIL8		
LB2		

**Species Availability (Wood)**

	Alder	Rustic Alder	Cherry	Rustic Hickory	Maple	Oak
SWVCRM8	•	Alder	•		•	•
MDENTIL8	•	Alder	•		•	•
LB2	•	Alder	•		•	•

**Species Availability (All Laminates)**

	High Glass	Horiz. Grain on Maple	Vert. Grain on Maple	Vert. Grain on Cherry	Vert. Grain on Oak
SWVCRM8	box color	box color	box color	box color	box color
MDENTIL8	box color	box color	box color	box color	box color
LB2	box color	box color	box color	box color	box color

**MOULDING STACK 17**

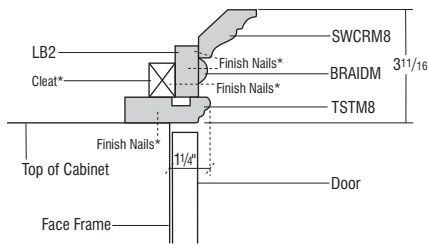
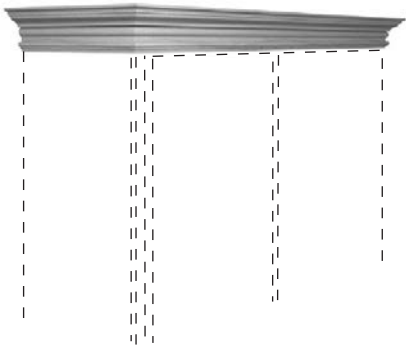

\*Cleats and finish nails not included.



**STKMLD17**

- Not recommended for use when taking application to the ceiling.

**Finish Techniques**

	Distressing	Heirlooming
SWCRM8	•	•
LB2		
BRAIDM		
TSTM8		

**Species Availability (Wood)**

	Alder	Rustic Alder	Cherry	Rustic Hickory	Maple	Oak
SWCRM8	•	Alder	•	Hickory	•	•
LB2	•	Alder	•	Hickory	•	•
BRAIDM	•	Alder	•	Beech	•	Beech
TSTM8	•	Alder	•	Hickory	•	•

**Species Availability (All Laminates)**

	High Glass	Horiz. Grain on Maple	Vert. Grain on Maple	Vert. Grain on Cherry	Vert. Grain on Oak
SWCRM8	box color	box color	box color	box color	box color
LB2	box color	box color	box color	box color	box color
BRAIDM	box color	box color	box color	box color	Beech
TSTM8	box color	box color	box color	box color	box color

**MOULDING STACK 18**

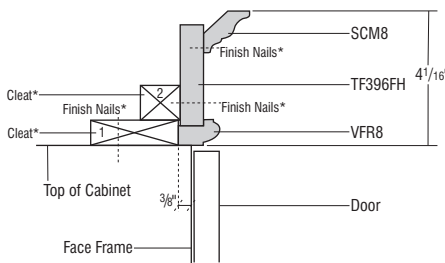
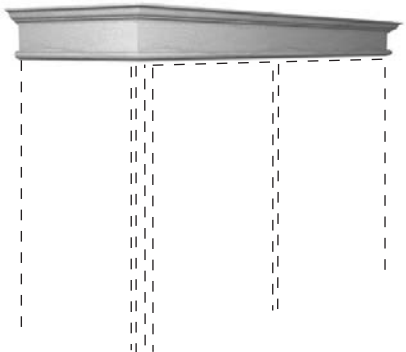

\*Cleats and finish nails not included.



**STKMLD18**

**Finish Techniques**

	Distressing	Heirlooming
SCM8	•	•
TF396FH	•	
VFR8		•

**Species Availability (Wood)**

	Alder	Rustic Alder	Cherry	Rustic Hickory	Maple	Oak
SCM8	•	Alder	•	Hickory	•	•
TF396FH	•	Alder	•	Hickory	•	•
VFR8	•	Alder	•	Hickory	•	•

**Species Availability (All Laminates)**

	High Glass	Horiz. Grain on Maple	Vert. Grain on Maple	Vert. Grain on Cherry	Vert. Grain on Oak
SCM8	box color	box color	box color	box color	box color
TF396FH	box color	box color	box color	box color	box color
VFR8	box color	box color	box color	box color	box color

**DESCRIPTION**

**MODEL**

**MOULDING STACK 19**

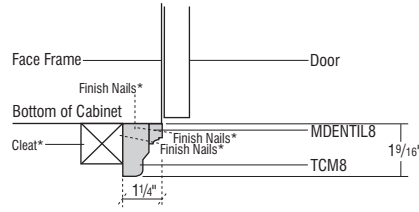
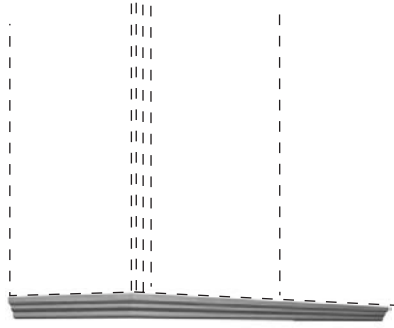

\*Cleats and finish nails not included.



**STKMULD19**

**Finish Techniques**

	Distressing	Heirlooming
MDENTIL8		
TCM8		•

**Species Availability (Wood)**

	Alder	Rustic Alder	Cherry	Rustic Hickory	Maple	Oak
MDENTIL8	•	•	•	•	•	•
TCM8	•	Alder	•	•	•	•

**Species Availability (All Laminates)**

	High Gloss	Horiz. Grain on Maple	Vert. Grain on Maple	Vert. Grain on Cherry	Vert. Grain on Oak
MDENTIL8	box color	box color	box color	box color	box color
TCM8	box color	box color	box color	box color	box color

**389**

**MOULDING STACK 20**

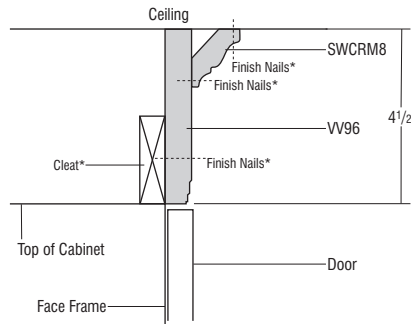
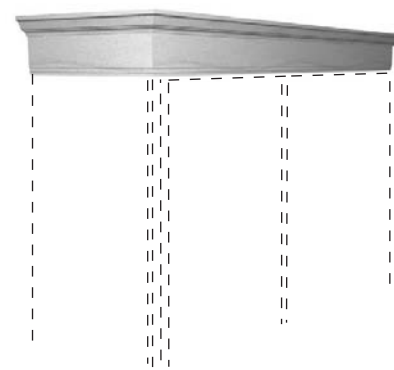

\*Cleats and finish nails not included.



**STKMULD20**

**Finish Techniques**

	Distressing	Heirlooming
SWCRM8	•	•
VV96	•	•

**Species Availability (Wood)**

	Alder	Rustic Alder	Cherry	Rustic Hickory	Maple	Oak
SWCRM8	•	Alder	•	Hickory	•	•
VV96	•	Alder	•	Hickory	•	•

**Species Availability (All Laminates)**

	High Gloss	Horiz. Grain on Maple	Vert. Grain on Maple	Vert. Grain on Cherry	Vert. Grain on Oak
SWCRM8	box color	box color	box color	box color	box color
VV96	box color	box color	box color	box color	box color

**MOULDING STACK 21**

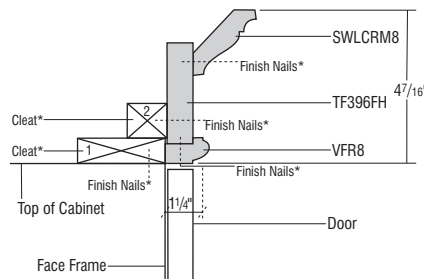
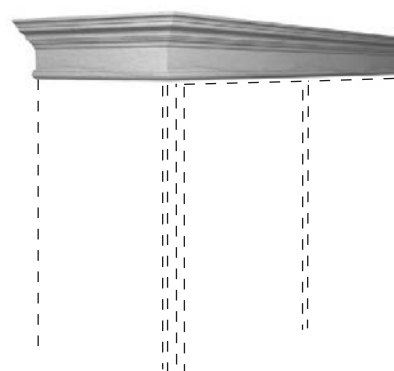

\*Cleats and finish nails not included.



**STKMULD21**

**Finish Techniques**

	Distressing	Heirlooming
SWLCRM8	•	•
TF396FH	•	
VFR8		•

**Species Availability (Wood)**

	Alder	Rustic Alder	Cherry	Rustic Hickory	Maple	Oak
SWLCRM8	•	Alder	•	Hickory	•	•
TF396FH	•	Alder	•	Hickory	•	•
VFR8	•	Alder	•	Hickory	•	•

**Species Availability (All Laminates)**

	High Gloss	Horiz. Grain on Maple	Vert. Grain on Maple	Vert. Grain on Cherry	Vert. Grain on Oak
SWLCRM8	box color	box color	box color	box color	box color
TF396FH	box color	box color	box color	box color	box color
VFR8	box color	box color	box color	box color	box color

**DESCRIPTION**

**MODEL**

**MOULDING STACK 22**

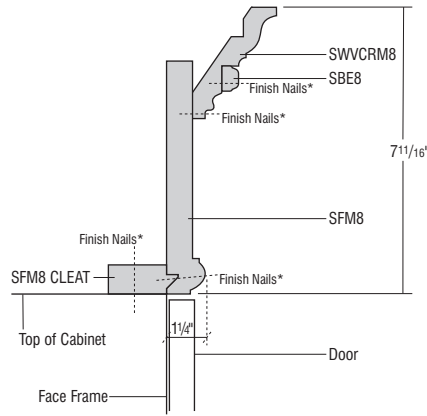
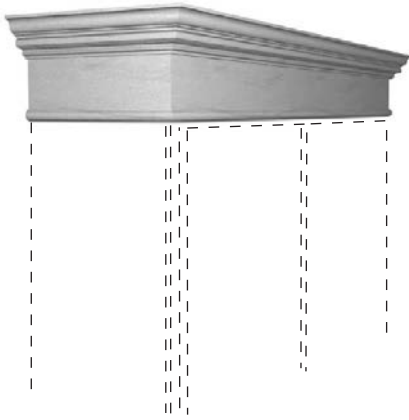

\*Cleats and finish nails not included.



**STKMLD22**

**Finish Techniques**

	Distressing	Heirlooming
SWVCRM8	•	•
SBE8		•
SFM8		•

**Species Availability (Wood)**

	Alder	Rustic Alder	Cherry	Rustic Hickory	Maple	Oak
SWVCRM8	•	Alder	•	Hickory	•	•
SBE8	•	Alder	•	Hickory	•	•
SFM8	•	Alder	•	Hickory	•	•

**Species Availability (All Laminates)**

	High Gloss	Horiz. Grain on Maple	Vert. Grain on Maple	Vert. Grain on Cherry	Vert. Grain on Oak
SWVCRM8	box color	box color	box color	box color	box color
SBE8	box color	box color	box color	box color	box color
SFM8	box color	box color	box color	box color	box color

**MOULDING STACK 23**

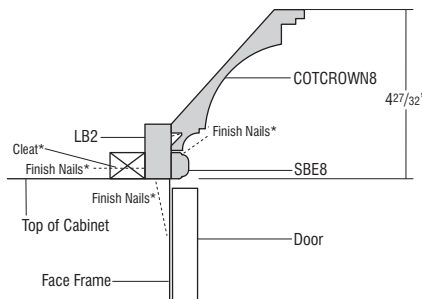

\*Cleats and finish nails not included.



**STKMLD23**

- Not recommended for use when taking application to the ceiling.

**Finish Techniques**

	Distressing	Heirlooming
COTCROWN8	•	•
LB2		
SBE8		•

**Species Availability (Wood)**

	Alder	Rustic Alder	Cherry	Rustic Hickory	Maple	Oak
COTCROWN8	•	Alder	•	Hickory	•	•
LB2	•	Alder	•	Hickory	•	•
SBE8	•	Alder	•	Hickory	•	•

**Species Availability (All Laminates)**

	High Gloss	Horiz. Grain on Maple	Vert. Grain on Maple	Vert. Grain on Cherry	Vert. Grain on Oak
COTCROWN8	box color	box color	box color	box color	box color
LB2	box color	box color	box color	box color	box color
SBE8	box color	box color	box color	box color	box color

**MOULDING STACK 24**

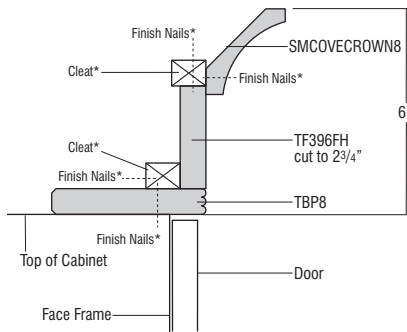

\*Cleats and finish nails not included.



**STKMLD24**

- Not recommended for use when taking application to the ceiling.

**Finish Techniques**

	Distressing	Heirlooming
SMCOVECROWN8	•	•
TF396FH	•	
TBP8		•

**Species Availability (Wood)**

	Alder	Rustic Alder	Cherry	Rustic Hickory	Maple	Oak
SMCOVECROWN8	•	Alder	•	Hickory	•	•
TF396FH	•	Alder	•	Hickory	•	•
TBP8	•	Alder	•	Hickory	•	•

**Species Availability (All Laminates)**

	High Gloss	Horiz. Grain on Maple	Vert. Grain on Maple	Vert. Grain on Cherry	Vert. Grain on Oak
SMCOVECROWN8	box color	box color	box color	box color	box color
TF396FH	box color	box color	box color	box color	box color
TBP8	box color	box color	box color	box color	box color

**DESCRIPTION**

**MODEL**

**MOULDING STACK 25**

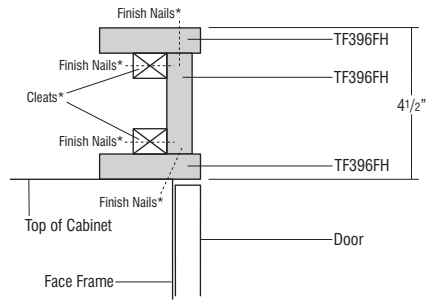
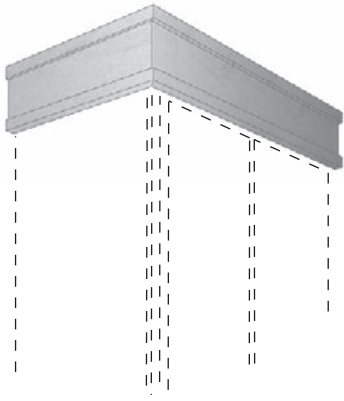

\*Cleats and finish nails not included.



**STKMLD25**

- Not recommended for use when taking application to the ceiling.

**Finish Techniques**

	Distressing	Heirlooming
TF396FH	•	

**Species Availability (Wood)**

	Alder	Rustic Alder	Cherry	Rustic Hickory	Maple	Oak
TF396FH	•	Alder	•	Hickory	•	•

**Species Availability (All Laminates)**

	High Gloss	Horiz. Grain on Maple	Vert. Grain on Maple	Vert. Grain on Cherry	Vert. Grain on Oak
TF396FH	box color	box color	box color	box color	box color

**391**

**MOULDING STACK 26**

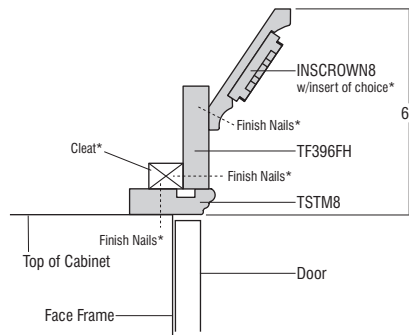

\*Insert must be purchased separately. Cleats and finish nails not included.



**STKMLD26**

**Finish Techniques**

	Distressing	Heirlooming
INSCROWN8		•
TF396FH	•	
TSTM8		

**Species Availability (Wood)**

	Alder	Rustic Alder	Cherry	Rustic Hickory	Maple	Oak
INSCROWN8	•	Alder	•		•	•
TF396FH	•	Alder	•		•	•
TSTM8	•	Alder	•		•	•

**Species Availability (All Laminates)**

	High Gloss	Horiz. Grain on Maple	Vert. Grain on Maple	Vert. Grain on Cherry	Vert. Grain on Oak
INSCROWN8	box color	box color	box color	box color	box color
TF396FH	box color	box color	box color	box color	box color
TSTM8	box color	box color	box color	box color	box color

**MOULDING STACK 27**

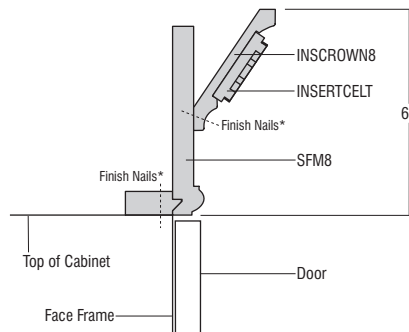
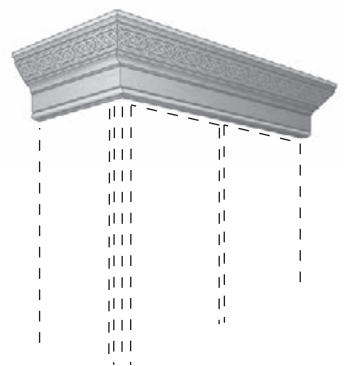

\*Cleats and finish nails not included.



**STKMLD27**

**Finish Techniques**

	Distressing	Heirlooming
INSCROWN8		•
INSERTCELT		•
SFM8		•

**Species Availability (Wood)**

	Alder	Rustic Alder	Cherry	Rustic Hickory	Maple	Oak
INSCROWN8	•	Alder	•		•	•
INSERTCELT			•		•	
SFM8	•	Alder	•		•	•

**Species Availability (All Laminates)**

	High Gloss	Horiz. Grain on Maple	Vert. Grain on Maple	Vert. Grain on Cherry	Vert. Grain on Oak
INSCROWN8	box color	box color	box color	box color	box color
INSERTCELT	box color	box color	box color	box color	box color
SFM8	box color	box color	box color	box color	box color

**DESCRIPTION**

**MODEL**

**MOULDING STACK 28**

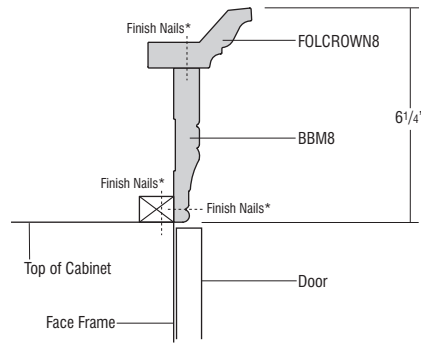
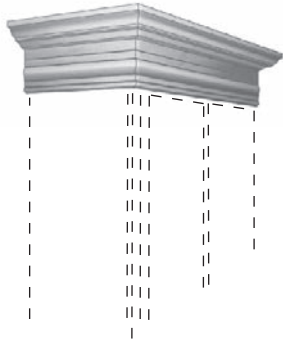

\*Cleats and finish nails not included.



**STKMLD28**

- Not recommended for use when taking application to the ceiling.

**Finish Techniques**

	Distressing	Heirlooming
FOLCROWN8		•
BBM8	•	•

**Species Availability (Wood)**

	Alder	Rustic Alder	Cherry	Rustic Hickory	Maple	Oak
FOLCROWN8	•	Alder	•	Hickory	•	•
BBM8	•	Alder	•	Hickory	•	•

**Species Availability (All Laminates)**

	High Gloss	Horiz. Grain on Maple	Vert. Grain on Maple	Vert. Grain on Cherry	Vert. Grain on Oak
FOLCROWN8	box color	box color	box color	box color	box color
BBM8	box color	box color	box color	box color	box color

Dear MasterBrand Customer,

Congratulations on your selection of MasterBrand cabinetry with an Heirloom finish. Because of its unique characteristics, this finish is quite different from other cabinetry finishes you may be familiar with. Your satisfaction is important to MasterBrand Cabinets, and we want you to fully understand the characteristics that make an Heirloom Finish unique.

The finish will be sanded through the base coat to expose the surface of the wood. This type of sand through on the edges and profiles creates a naturally worn appearance. If a finish is chosen with a glaze, the glaze will be applied after sanding has been done. This will enhance those areas of exposed wood to take on the darker characteristics of the applied glaze.

Normal Characteristics of Painted, Sand-Through Finishes include:

- Hairline Cracking
- Visible textures of natural grain patterns
- Variation in rub through and wear techniques

Accordingly, we ask that the following agreement be signed for Heirloom Finish orders.

---

I have read the foregoing and find the characteristic variations of wood with Heirloom finish are desirable. As such, I agree not to hold MasterBrand Cabinets and/or the MasterBrand dealer listed below responsible in the event that these characteristics are later found by me to be less desirable than I had expected.

---

Customer Signature

---

Dealer Signature

---

Customer Name (please print)

---

Dealer Name (please print)

---

Dealer Purchase Order Number

Dear MasterBrand Customer,

Congratulations on your selection of MasterBrand cabinetry in a Paint or Paint with Glaze finish. Because of its unique characteristics, this finish is quite different from other cabinetry finishes you may be familiar with. Your satisfaction is important to MasterBrand Cabinets, and we want you to fully understand the characteristics that make painted finishes so distinctive.

It is important to realize that the beauty of wood cabinetry comes from the natural qualities of wood itself. MasterBrand Cabinets utilizes only select solid hardwoods and veneers. The beauty of these genuine woods lies in the variation of the grain. The textures of those natural grain patterns often remain visible with paint finish and should be accepted as inherent characteristics when selecting painted cabinetry. When ordering painted Maple 5-piece styles (except Door 46), the door's center panel will be constructed of MDF material.

On both Maple and MDF, seam lines and hairline cracking at stile, rail and panel joints are normal characteristics of painted finishes and should not be considered a reason for product replacement. Over time, there may be a slight color shift in the paint finish due to the continued exposure to natural and artificial light sources. We mention these characteristics because neither MasterBrand Cabinets nor your MasterBrand dealer can be responsible for these conditions and variations.



*Example of front joint separation*



*Example of front joint separation*



*Example of end joint separation*

Accordingly, we ask that the following agreement be signed for Paint Finish orders.

---

I have read the foregoing and find the characteristic variations of wood and MDF with painted finish are desirable. As such, I agree not to hold MasterBrand Cabinets and/or the MasterBrand dealer listed below responsible in the event that these characteristics are later found by me to be less desirable than I had expected.

\_\_\_\_\_  
Customer Signature

\_\_\_\_\_  
Dealer Signature

\_\_\_\_\_  
Customer Name (please print)

\_\_\_\_\_  
Dealer Name (please print)

\_\_\_\_\_  
Dealer Purchase Order Number



Dear MasterBrand Customer,

Congratulations on your selection of MasterBrand cabinetry in Rustic Alder. Because of its unique characteristics Rustic Alder is quite different from other wood types you may be familiar with. Your satisfaction is important to MasterBrand Cabinets, and we want you to fully understand the characteristics that make Rustic Alder so distinctive.

It is important to realize that the beauty of wood cabinetry comes from the natural qualities of wood itself. Rustic Alder is characterized by its light brown and reddish undertones and may contain a variety of pin holes, open and closed knots of various sizes and colors, small cracks, bird pecks, mineral streaks, and grain variation. Some knots may have small holes through the panel. Larger holes will not be filled. In addition, the wood will contain color difference caused by variations in minerals found in the soil, creating visible mineral tracks. However, those characteristics that might compromise the structural integrity of the door will not be included.

Sound Closed Knot (not moveable) – Expected in Rustic Alder up to approximately 3” diameter.

Sound Knot with Cracks – Expect sound knots with open cracks up to approximately 1” in length.

Open Knot (through door) – Expected in Rustic Alder with open area up to approximately 3/4” diameter.

Note: 3/4” diameter is about the size of a penny. Holes created by open knots pass completely through the door and are desirable for this rustic look.

Unsound Knot (moveable core) – Not to be expected.

Knot Cluster (cluster of tight sound knots) – To be expected in Rustic Alder.

Worm Holes/Pin Holes (can go through door) – Can be expected on Rustic Alder up to approximately 1/4” diameter.

Worm Tracks – Can be expected on Rustic Alder in sizes up to approximately 1/8” wide by 8” long.

Rustic Alder as described is featured for doors, drawer fronts, and selected mouldings. Other areas of the product will utilize standard hard Alder. Customers should expect a much lower occurrence of rustic characteristics in these other areas. Also, the natural characteristics mentioned occur randomly in Rustic Alder. All doors, drawer fronts, and selected mouldings will contain some combination of the common Rustic Alder markings; however, it will be uncommon to find all markings on any single piece.

The natural characteristics of wood described above and variations in grain patterns and color are not considered reasons for product replacement. We mention these characteristics because neither MasterBrand Cabinets nor your MasterBrand dealer can be responsible for these conditions and variations.

Accordingly, we ask that the following agreement be signed for Rustic Alder orders.

---

I have read the foregoing and find the characteristic variations of wood with Rustic Alder are desirable.

As such, I agree not to hold MasterBrand Cabinets and/or the MasterBrand dealer listed below responsible in the event that these characteristics are later found by me to be less desirable than I had expected.

---

Customer Signature

---

Dealer Signature

---

Customer Name (please print)

---

Dealer Name (please print)

---

Dealer Purchase Order Number

Dear MasterBrand Customer,

Congratulations on your selection of MasterBrand cabinetry in Rustic Hickory. Because of its unique characteristics Rustic Hickory is quite different from other wood types you may be familiar with. Your satisfaction is important to MasterBrand Cabinets, and we want you to fully understand the characteristics that make Rustic Hickory so distinctive.

Rustic Hickory is a strong, heavy hardwood known for distinctive graining patterns. Color will vary from nearly white to dark brown, with wild, flowing grain patterns and dramatic color variations. Rustic Hickory can have a fine uniform grain to large knots appearing black and brown in color of various shapes and sizes, sapwood, mineral and some checking.

Sound Closed Knot (not moveable) – Expected up to approximately 3” diameter.

Sound Knot with Cracks – Expect sound knots with open cracks up to approximately 1” length.

Open Knot (through door) – Expected with open area up to approximately 3/4” diameter.

Unsound Knot (moveable core) – Not to be expected.

Worm Holes/Pin Holes (can go through the door) – Can be expected up to 1/4” diameter.

Worm Tracks – Can be expected in sizes up to approximately 1/8” wide by 8” long.

Note: 3/4” diameter is about the size of a penny. Holes created by open knots pass completely through the door and are desirable for this rustic look.

Doors, drawer fronts, and selected trim items will feature rustic characteristics. Other areas of the product will utilize standard Hickory.

The natural characteristics of wood described above and variations in grain patterns and color are not considered reasons for product replacement. We mention these characteristics because neither MasterBrand Cabinets nor your MasterBrand dealer can be responsible for these conditions and variations.

Accordingly, we ask that the following agreement be signed for Rustic Hickory orders.

---

I have read the foregoing and find the characteristic variations of wood with Rustic Hickory are desirable.

As such, I agree not to hold MasterBrand Cabinets and/or the MasterBrand dealer listed below responsible in the event that these characteristics are later found by me to be less desirable than I had expected.

---

Customer Signature

---

Dealer Signature

---

Customer Name (please print)

---

Dealer Name (please print)

---

Dealer Purchase Order Number

Code	Page Number
1TWT	270
2DB	199
2DB..DR	200
2DB..FD	199
2DB..PDO	199
2DB..RT	200
2DB..RTPDO	200
3CDB	196
3DB	201, 220,
	267
3DB..WD	203
3DB..WTC	202
3DBB	201
3DBBDD	203
3DBDD	203
3TWT	271
4DB	204
4DB..WTC	204
4TWT	272
4VDB	281
ABFOOT	352
ACAM	337
ACS	48, 179
ACSF	180
ACSF	180
ADDTK	54
ALF	59
ANGLHEATSHIELD	372
ANGLHSHIELDSS	372
APC	38
AUTHB, AUTHL, AUTHR	43
AV	345
B	155-156,
	219
B..CIA	198
B..COA	197
B..CWP	170
B..DR	213
B..FH	158, 159
B..FHMIXSC	172
B..FSCO	169
B..PS	168
B..RT	165
B..RTWTC	167
B..TDRO	171
B..WTC	157
BATTEN	337
BATTLI	363
BBCPO	212
BBM	340
BBMFB	340
BBMSC	340
BBMSH	340
BBMSW	340
BBMWD	215
BBTP	207
BC	185
BC..PO	186
BCF	307-312
BCFW	186
BCFW..CPO	187
BCFW..FH	187
BCFW..PO	187
BCFW..SP	188
BCOPP	211
BCP	217
BCP..FH	217
BEC	198
BED	323
BEP	316
BEP..AEL, AER	321
BEP..VG	322
BEPP	319
BEPS	313
BER	191
BERAS	191
BKSOCKET	380
BLOWER	151
BLS	189

Code	Page Number
BLSBEP	317
BLVDF	307
BMC	213
BMW	216
BMW..DD	216, 220
BMW	215
BO	215
BOC	218
BP	314
BP..CRSGR	315
BP..VG	315
BPM	337
BPP	210
BPPP	168
BPS	370
BPT..WB	205
BPT..WBFH	207
BQRES	218
BRACKETIND	359
BRAIDM	336
BRDB	195
BRKOFFSCREW	383
BRMCLP	371
BSC3OPR, R, RP, RS, SR	161
BSC36PRP, PRS, SRP, SRS	163
BSD	209
BTC	197
BTDP	210
BUMPERPADS	383
BUNLEG	346
BUPP	211
BUPPKB	212
BV2SC3OPR, RP, RS, SR	162
BV2SC36PRP, PRS, SRP, SRS	164
BWB	205
BWB..FH	206
BWBFHLID, BWBLID	370
BWC	209
CABCLEANKIT	381
CABL	364
CABRIG	364
CABMAT	371
CABMATV	371
CAPM	341
CBO	45
CCM	337
CCO	45
CD	136
CF	302
CFNTO	58
CFP	45
CFRMO	58
CG, CG..BTM, CG..TOP	60
CIW	371
CLTCROWN	332
CMAT	50
CND	45
CNTYSB	181
CNTYSB..CM	181
CNTYSB..SA	183
CONNFLX	364
CONVERSION	152
CORBELART9	355
CORBELBAU	357
CORBELCOVE	355
CORBELCR	355
CORBELMIS6	356
CORBELMIS9	356
CORBELOWD5	356
CORBELTRIAD	357
COTCROWN	332
COVECROWN	332
CPE	337
CPES	341
CS	179
CTDK	375
CUDD	371
DA5PCDF	328

Code	Page Number
DAB..FS	189
DAB..SLS	190
DADOOR	327
DAPNL	326
DASLBDF	328
DB	199-204
DCM	343
DDFD	268
DDO	266
DER	269
DFD	267
DF5PC	39
DF5PCNR	39
DF5PCNRST	40
DF5PCSLBT	40
DF5PC	39
DF5PCSLBT	41
DFSLB	39
DFSLBT	41
DGBOXLOCK	380
DGK	380
DIMM	364
DLEMISSION	349
DOOR	330
DOORSLAB	331
DPSRR	42
DRT	51, 377
DRWPWR	52, 374
DRWSEC	50
DRWTK	57
DW	122-123
DW..D	124
DW..DS	125
DW..P	127
DW..S	124
DWB..FH	268
EDGEHAND	372
EGD	336
ENDRIG	364
ENGBARCOLUMN	347
ENGLSCOLUMN	347
ER	128
ES	361
ET	51
EXBKL, EXBKR	47
EXL, EXR	48
EZORG	374
F	302
F..R	302
FALSEPNLCLIPSO	380
FB	43
FBF	307
FBLR	341
FD	50, 269
FDWB	270
FFDL, FFDR	43
FFP	346
FLEX	363
FOLCROWN	332
FOOTMETAL	359
FPEB	43
FS	360
FTK, FTK..FNT.P, FTK.P	54
FTKAV, FTKAV..FNT.P, FTKAV.P	54
FTKFV, FTKFV..FNT.P, FTKFV.P	54
FV	345
GAEICILEG	348
GLAZEPEN	381
HINGE	382
HINGEFH	370
HINGERESCLIP	382
HINGESHIM	382
HL	154
HM	154
HP..21	154
HS	154
ICM	343
ID	46
INSCROWN	333

Code	Page Number
INSERTCELT	336
INSTALLSCR, INSTALLSCREWS	383
INVRM	49
IR	364
ISLETPRD	349
ISLLEG	348
JBRACKETART	356
JBUFFETLEG	346
JCORBELCOS13D	355
JCORBELCRAFTO	356
JCORBELSHKR	357
JCOSFOOT	352
JCOSMOLLEG	347
JCRAFTFOOT	352
JCRBUNFOOT	352
JENGCNTYLEG	347
JESTATELEG	348
JESTATELEGS	347
JESTATELEGSS	347
JFRNCNTYLEG	348
JGSK	362
JINSERTLRC	343
JINSERTLRT	342
JMADEFEET	353
JMETROFOOT	353
JPWRPOD	374
JRCPV	345
JRPV	345
JSOC	358
JSPLEGSS	349
JSQBARLEG	350
JSQFOOT	353
JSQFOOTS	353
JSQSLLEG	350
JSRC	358
JURNLEG	352
JWHCA	148
JWHCS	149
JWHL	145
JWHSHPCH	146
JWHSHPSTR	145
JWHSHPSTRCB	146
JWHSHPST	146
JWHSHPSTCB	146
KCPU	372
KNOB	365
L	296
LB	342
LBRM	338
LC	295
LCHAMPERLNR	373
LCRH	295
LEADFLX	364
LEADRIC	364
LGCORBEL	355
LGSQFOOT	353
LIDSTAY, LIDSTAYHD	382
LIFOOT	353
LO	373
LOSC	343
LRM	342
LSACROWN	333
LSHAKER	334
LSP	196
LT	295
LTD	296
LTI	51
MC	301
MD, MD..BTM, MD..TOP	61
MDCCRNSHLF	360
MDENTIL	336
MDFLCRNHLF	361
METBARCOLUMN	349
METISLCOLUMN	349
MFO	42
MIP	44
MIXKITFHSC	370
MSACROWN	333
MTCROWN	333

Code	Page Number
MTUK	381
MW	134
OCT35	344
OCD, OCD..DD, OCD..WD, OCD..WDE	245-250
OCINSTALLKIT	373
OCM	343
OCS, OCS..DD, OCS..WD	240-244
OGEEEM	338
OL	303
OL..MFO	303
OMC, OMC..DD, OMC..WD	253-257
OSB	238-239
P	58
PDM	383
PDO, PDOPOSTS	373
PE	38
PFALSEPNLCLIP50	380
PFINBTMB	47
PLBLOCK	354
PPP	373
PRMD	63
PTOWB	52
PTU	234
PTUS	233
PUCK	363
PULL	365
PWT	237
PY	236
Q4ZONECON	364
QDIMREC	364
QRM	344
QUARTCOLOR	381
RD	46
RECTKALL	56
RECTKBK	56
RECTKL	56
RECTKR	56
RETCLIP..BAG	383
RIGID	363
ROSETTEMIS	346
RPM	336
RT	51, 377
RTBFH	214
RTBKXSP	380
RVWS	221
S96	303
SACROWN	333
SB	173-175, 219
SB..CM	173
SB..D	178
SB..S	177
SB..SCM	177
SB..ST	175, 220
SB..STCM	176
SB..STS	177
SB..STSCM	178
SBC	184
SBE	338
SBM	338
SBP	338
SBS	356
SCM	334
SCPDRW	42
SCRIBE	338
SFB	179
SFM	335
SHELFBKRTSN	360
SHELFPEGS, SHELFPEGCTR	383
SHKRCRM	333
SHLFPD	374
SHM	344
SHMD	62
SK	362
SLS	192, 220
SLSR	193
SLSW	193
SM	337

Code	Page Number
SMCORBEL	355
SMCOVECROWN	334
SMLR	342
SOFFITA	342
SOFFITE	342
SPACERBLK	380
SPD	374
SPLEG	349
SPRINGEND	354
SPRINGSPOOL	354
SQLEG	351
SQLEGTAP	351
SRCH	374
SSC	381
SSFSH	360
STAND	363
STBRACKETIND	360
STDW	126
STR	374
STR8	335
STRS	336
STRTHEATSHIELD	373
STRTHSHIELDSS	373
STW	114
STWC	120
SWCRM	334
SWLCRM	335
SWTCRM	335
SWVCRM	335
TAPLG	354
TB	341
TBC	262-263
TBCD	264-265
TBEM	339
TBMWB	251
TBP	339
TCM	337
TD	53, 171
TD..FH	172
TDKIT	375
TDRO	376
TED	323
TEP, TEP..AEL, TEP..AER	317, 322
TEP.VG	322
TEPS	313
TF	302
TKC	341
TKP	56
TKTLFOOT	354
TLFOOT	354
TOEKICKVAC	375
TOT	375
TOTSSS	52, 375
TOUHLATCH	359
TPP	235
TRIBRKT	359
TSTM	339
TUK	381
TURNEPOST	351
TV	301
TVRAV, TVRFV, TVRVV	49
TWH	150
U	222-227
U..RT	228-230
UCD	272, 294
UCDT	272, 294
UOC	231
UOCDZ	232
UPM	339
V	273-274
VB	278
VBEP	318
VBH	294
VBWB	281
VCR	376
VDB	280
VDL	322
VDL..WD	221
VER	280

Code	Page Number
VFR	342
VGPO	283
VH..FH	294
VM	301
VMP	300
VP	283
VSB	275-276
VSB.....U	277
VSB.....WB	277
VSD	284-292, 293
VSD..FP	292, 293
VSDS	290
VSSB.....ST	278
VSSB.....STWB	277
VSWD..FP	290
VTK	57
VU	296
VV	345
VWB	282
VWC	299
VWH	297
VWM	299
VWS	221
W	88-110, 141, 299
W..BC	258
W..CIA	129
W..PO	98, 102 104
W..SHLFPD	139
W2D	111, 112
W3D	113
WAGD	135
WAGVLD	136
WAIN	325
WB	160
WBCPO	137
WBCPOKCLIP	373
WBMW	134
WC	117-119
WCT	344
WEAS	110
WEC	130
WED	324
WEP	318
WER.VG	322
WEPS	314
WFBC	260
WGH	376
WHA	143
WHAFP	144
WHC	145
WHCA	148
WHCS	149
WHS	144
WHSBATTEN	149
WHSFP	144
WHSMT	148
WHSMT	147
WHSMTCB	147
WLI	44
WMC	143
WMF	338
WNR	140
WO	142
WQRES	131-133
WSC	141
WSCRIB	339
WSD	142
WSK	376
WSP	139
WSR	140
WTCD	372
WTH	87-101
WTHRESCIP	382
WVL	96-101

# Protection for your investment

## Limited Lifetime Warranty (Residential Purchaser)

MasterBrand Cabinets, Inc. (“We” or “Us”) extends the following limited lifetime warranty (“**Limited Warranty**”) to the first Residential Purchaser (“You” or “Your”) of a cabinet or vanity manufactured by Us (each, a “**Product**”). This Limited Warranty is only applicable to Products sold to the first Residential Purchaser and used in the applications described below within the United States and Canada. Except as allowed below or by applicable law, You may not assign or transfer this Limited Warranty.

**WHO IS A RESIDENTIAL PURCHASER?** Under this Limited Warranty, a “**Residential Purchaser**” means any of the following:

- a person who purchases and installs the Product in a dwelling that is owned and used by that person as a primary or secondary home;
- any person or business such as a builder, contractor or developer that purchases and installs the Product in a newly constructed or remodeled dwelling that will be used by the initial owner/purchaser of that dwelling as a primary or secondary home. In such situation, this Limited Warranty may be assigned to the initial owner/purchaser who uses the dwelling as a primary or secondary home.
- a consumer subject to the Quebec *Consumer Protection Act*.

Under this Limited Warranty, a primary or secondary home does not include rental property. This Limited Warranty does not apply to landlords, leasing companies or other commercial purchasers. (See Commercial Warranty)

**WHAT DOES THIS LIMITED WARRANTY COVER?** Subject to the exclusions and limitations set forth in this Limited Warranty, We warrant to You that each Product will be free from defects in material and workmanship, under normal use and maintenance, for the applicable warranty period stated below. This warranty gives You specific legal rights, and You may have other rights which vary from State to State or Province to Province.

**WHAT IS THE WARRANTY PERIOD APPLICABLE TO RESIDENTIAL PURCHASERS?** The warranty period for Your Product (excluding certain components discussed in the following paragraph) begins on the date the Product was purchased, whether purchased by You or by a third party on Your behalf. Your warranty is only valid if you use the dwelling as your primary or secondary home and does not extend to future owners if the property is sold.

Notwithstanding the preceding paragraph, the warranty periods applicable to the following Product components that were not originally manufactured by Us are as follows:

- Vent Hoods, Blowers, and components: 1 year from the date of original purchase
- Lighting, Electronic, and Powered components: 2 years from the date of original purchase.
- Decorative Hardware: 5 years from the date of original purchase.

**DISCLAIMER OF OTHER WARRANTIES:** IF YOU ARE A CONSUMER SUBJECT TO THE QUEBEC CONSUMER PROTECTION ACT, THE EXCLUSION OF WARRANTIES CONTAINED IN THE IMMEDIATELY FOLLOWING PARAGRAPH DO NOT LIMIT YOUR RIGHTS AND REMEDIES UNDER SUCH ACT, INCLUDING THE RIGHT TO MAKE A CLAIM UNDER ANY OF THE STATUTORY WARRANTIES PROVIDED UNDER SECTIONS 34 TO 54 OF SUCH ACT. CERTAIN OTHER STATES OR PROVINCES DO NOT ALLOW LIMITATIONS ON HOW LONG AN IMPLIED WARRANTY LASTS, SO THE BELOW LIMITATION MAY NOT APPLY TO YOU.

THIS LIMITED WARRANTY IS OUR SOLE AND EXCLUSIVE WARRANTY WITH RESPECT TO THE PRODUCTS. ALL IMPLIED WARRANTIES ARE STRICTLY LIMITED TO THE DURATION OF THE LIMITED WARRANTY APPLICABLE TO THE PRODUCT AS STATED ABOVE, INCLUDING BUT NOT LIMITED TO, ANY WARRANTY OF MERCHANTABILITY OR OF FITNESS FOR A PARTICULAR PURPOSE.

**WHAT THIS LIMITED WARRANTY DOES NOT COVER (EXCLUSIONS):** The Limited Warranty does not apply to any Product:

1. installed or used outdoors;
2. used for purposes for which it is not designed or intended by Us;
3. which has been subjected to misuse, vandalism, abuse, negligence, accident, or unauthorized modifications;
4. which has been improperly stored (if the Product must be stored, it should be covered and stored in a humidity and temperature controlled environment, away from direct sunlight);
5. which has been improperly installed, cleaned, or maintained (for more information regarding the proper use and care of the Product, please consult the applicable Use and Care Instructions that accompanied the Product or that can be found at [www.masterbrand.com/care-and-cleaning](http://www.masterbrand.com/care-and-cleaning));
6. which has been subjected to improper temperature, moisture and/or humidity extremes (temperature outside the range of 50-85°F (10-29°C) and humidity outside the range of 30-55% are considered extreme);
7. damaged by fire, flood, acts of God, or other external causes beyond our control;
8. varying in color and characteristics due to age, sunlight, smoke, or other environmental conditions;
9. exhibiting any effects on the color and/or integrity of the finish/color or appearance due to the use of abrasive cleaners, cleaners that contain chlorine, acidic cleaners, scuffing sponges or steel wool; and/or
10. exhibiting normal wear and tear.

In addition, natural materials may vary in color and characteristics and exhibit subtle changes as they age. For example, painted doors, drawer fronts, and face frames may eventually have visible cracking around the joint area, and cabinet colors may darken or lighten over time. These variations are considered to be the nature of the material in relation to their environmental exposure and are not covered under this Limited Warranty.

**SOLE AND EXCLUSIVE REMEDY:** In the event of a defect in the workmanship or materials of a Product or Product component occurring during the warranty period described above, We will, at our option, repair or replace any defective Product or Product component; provided, if it is not commercially feasible to repair or replace a defective Product or Product component, We may refund the original price paid by You for the defective Product or Product component, or provide a credit towards a similar type of product sold by Us. The foregoing are Your sole and exclusive remedies for any Product defect or non-conformity. By way of example but not limitation, the following costs and expenses are not covered by this Limited Warranty: (1) labor costs for the original installation, removal, or reinstallation of the Product, or defective part thereof; (2) labor costs or material charges for the removal, reinstallation, repainting, refinishing or replacement of any other items or building materials which must be removed, replaced, reinstalled, or refinished in order to repair or replace the defective Product or component. For example, costs associated with the following will not be reimbursed: counters, sinks, tiles, flooring, accessories, appliances or plumbing fixtures. When a claim for warpage, joint separation or material growth is submitted, We may, at our option and after inspection, defer action for up to 12 months to allow the Product to acclimate to the installed environment. Further, We reserve the right to modify or alter any Product design, specifications or materials without obligation to make similar changes to Products previously manufactured or sold by Us.

The repair or replacement remedies offered by Us under this Limited Warranty are contingent on the current Product offerings of styles and construction options within our Product line at the time a warranty claim is made by You. If a valid warranty claim is filed for an obsolete Product, We reserve the right, at our sole option, to honor its repair or replacement obligations under this Limited Warranty by either: (1) replacing the affected Product or component with a new Product or component of the same or approximate style or color from our current Product line or offerings; or (2) replacing the affected Product or component to achieve a uniform appearance with a similar or comparable product style or approximate color of the originally purchased style. If a Product or components are replaced or repaired, We cannot guarantee an exact match with the finish/color or appearance of other products or fixtures installed at Your dwelling. This is due to changes that may occur during the Products' natural aging process, affecting its color and/or grain.

**LIMITATION OF LIABILITY:** If You are a consumer subject to the Quebec *Consumer Protection Act*, the limitations of liability contained in the immediately following paragraph do not release Us from the consequences of our own actions or the actions of our representatives. Certain other States and Provinces do not allow the exclusion or limitation of incidental or consequential damages, so the below limitation or exclusion may not apply to You.

The remedies described above are Your sole and exclusive remedies and our entire liability for any breach of this Limited Warranty. Our total liability shall under no circumstances exceed the actual amount paid by You for the defective product. Further, We shall not under any circumstances be liable for any consequential, indirect, incidental, special or punitive damages or losses (including lost profits), even if this Limited Warranty is deemed to have failed of its essential purpose.

**HOW DO YOU OBTAIN WARRANTY SERVICE?** This Limited Warranty can also be found in the documentation that accompanied Your Product. To obtain more information regarding the Product or to make a claim under this Limited Warranty, contact one of our authorized dealers or distributors, who will arrange for inspection of the Product. A dated sales receipt as proof of purchase is required to obtain benefits from this Limited Warranty. If you have difficulty obtaining assistance, please write to:

MasterBrand Cabinets, Inc  
Attn: Consumer Affairs  
One MasterBrand Cabinet Drive  
P.O. Box 420  
Jasper, IN 47547-0420



## OUR COMMITMENT TO CHANNEL PARTNERS, DESIGNERS AND CUSTOMERS

The Express Response™ program is designed to expedite orders when customers need product faster than normal lead times to correct problems with an existing order. Below is an overview of the program and what you can expect from our commitment to superior service.

### GUIDELINES

- Orders must be submitted using the OneTouch Express Response function to receive rush expediting. All phoned-in, faxed or emailed orders will follow current standard lead times.
- Warranty or replacements for orders no longer available on OneTouch should be placed by fax or email using the updated ER Order form.
- Order must be associated with a previous order number.
- All orders received by 12 NOON E.T. Monday-Friday will be automatically scheduled for Express Response that same day. Orders received after the cutoff time will be processed on the next business day.
- Lead time calculation is based on receipt of a clean order on a credit-worthy account. Clean orders are orders in which all information is provided and accurate.
- There is no additional upcharge for Express Response.
- There are no cancellations or returns once order is received.
- Due to the special nature of Special Orders and Appliance Panels, they are excluded from the Express Response program and will be processed as a standard lead time order.
- Express Response is available within the continental United States. Should Alaska, Hawaii or international shipments be required, customer service representatives are ready to assist by providing shipping information and determining lead times.

### LEAD TIMES

**12 WORKING DAYS OR LESS FROM ORDER TO DELIVERY** (channel partner or home delivery agent):

- Items shipped via LTL (via SuperPAC™) or truckload.
- Includes all catalog items except those that can be expedited through the 5-day program listed below.

**5 WORKING DAYS FROM ORDER TO DELIVERY:**

- Qualified items are designated in the Specification Guide with an icon
- Items will ship via parcel ground.
  - o Lead time calculation allows for 2 days parcel ground shipping time. Some geographic areas may require additional shipping time.
- For orders containing both 12 day and 5 day items, the longer lead time applies.



QUESTIONS? If you have questions that aren't answered here,  
contact your Customer Service team.