



# Schrock™

*trademark™ series*

SPRING 2020 PRODUCT INTRODUCTION

# Schrock™ *trademark™ series*

## **Sophisticated Style. Intelligent Design.™**

Say hello to an easier than ever Schrock™ Trademark™ Series designing and selling experience. We've made great strides in aligning the Schrock enterprise this launch with the introduction of new doors, finishes, hardware and embellishments that span across multiple series. The 2020 launch also brings several new SKUs, ensuring your designs are as functional as they are beautiful, with the robust offering of intelligent storage options nestled behind every perfectly hued door.

Whether you're looking for designer-inspired color, intelligent storage, or just simple style basics, trust Schrock to deliver the design flexibility you want, the price breadth you need and the service you deserve in one complete brand experience.

Wishing you a fulfilling year of creativity and prosperity. From all of us to you, we look forward to remaining your trusted cabinetry partner.



Ingalis Maple Coconut Paint

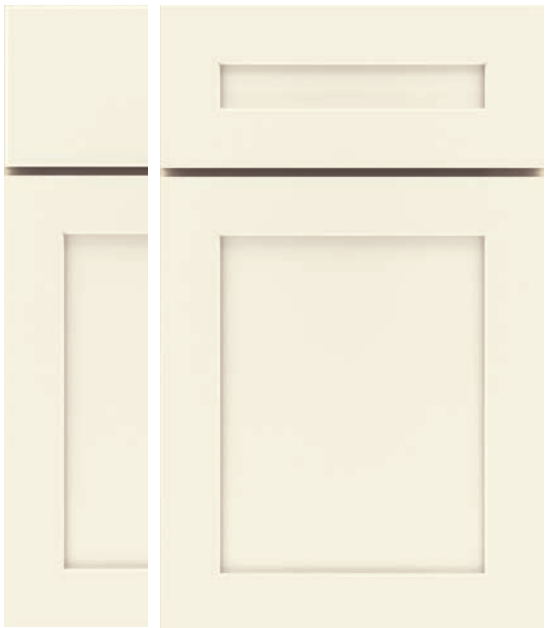

Ingalis Maple Coconut Paint

## *ingalis*

---

Continuing to build our enterprise story, the Trademark Series is pleased to launch the Ingalis door style. Available in Alder, Maple, Oak, Rustic Alder and Rustic Hickory with a standard slab or optional 5-piece drawer front, this quintessential Shaker door style is also available in the Entra Series.



Lormand Rustic Hickory Thatch Stain



Lormand Maple Egret Paint

## *Lormand*

---

New to the Trademark Series, Lormand is also an option in the Entra Series and features a standard slab drawer front. Available in Alder, Maple, Oak, Rustic Alder and Rustic Hickory wood species, Lormand is the partial overlay version of the Ingalls door style.



Willet Cherry Henna Stain



Willet Maple Limestone Paint

## willet

---

Currently a popular door style in the Entra Series, Willet, now available in the Trademark Series, makes it easy for customers to trade-up to a more robust color palette and storage offering. Available in Cherry, Maple, Oak and Rustic Hickory wood species with a standard slab drawer front and an optional 5-piece drawer front.



Galvyn Maple Sahara Stain

## galvyn

---

Galvyn replaces the Brookshire door style, providing a more modern aesthetic. Available in Cherry, Maple and Oak wood species, this partial overlay door features a slab drawer front and is available in both the Trademark and Entra Series.



Rivali Maple Sahara Stain

## rivali

---

Rivali, a modern slab door available in Cherry and Maple, is the perfect solution for consumers with contemporary style preferences. Available in both the Trademark and Entra Series, this veneer slab style features vertical grain on the door and drawer fronts resulting in an alternative look for customers seeking slab designs.



Lainey Maple Limestone Paint

## *lainey*

---

If your customer is in search of a transitional door style with sophisticated appeal, Lainey is the perfect option. Available in Cherry and Maple with a slab drawer front, Lainey is available in both the Trademark and Entra Series.



Natcher Maple Limestone Paint

## *natcher*

---

The Natcher door style, available in Cherry and Maple, features a slab drawer front and is the partial overlay version of the Lainey door style. Available in both the Trademark and Entra Series.



Kayes Maple Sahara Stain

## *kayes*

---

This on-trend door style, available in both the Trademark and Entra Series, is offered with a standard slab or optional 5-piece drawer front in Cherry and Maple wood species.



Harwell Maple Sahara Stain

## *harwell*

---

The Harwell door style, available in Cherry, Maple and Oak, includes square or arch wall doors and square base doors with slab drawer fronts. Featuring an updated door profile, this partial overlay, veneer raised panel door, available in both the Trademark and Entra Series, is the perfect choice for traditional consumers.



# aluminum frame doors

---

Four new on-trend aluminum frame doors make their way to the line-up, including Aluminum Finish with Clear Glass, Brushed Stainless Finish with Clear Glass, Black Powder Coat Finish with Clear Glass, and Black Powder Coat Finish with Frosted Glass. With these additions, four Aluminum Frame styles are no longer available. See page 23 for a complete list.



Aluminum Finish with Clear Glass



Brushed Stainless Finish with Clear Glass



Black Powder Coat Finish with Clear Glass



Black Powder Coat Finish with Frosted Glass



## colt

---

Conjuring up images of a beautiful foal, Colt is a unique, mid-tone stain option with warm appeal available in both the Trademark and Entra Series. This on-trend brown could easily be the one your customer has been envisioning, and pairs easily with many of today's most popular finishes. In the Trademark Series, Colt is available in Maple, Cherry, Alder, Rustic Alder, Rustic Hickory and Oak in Matte or Satin Sheen.



Colt Stain Shown On Cherry



# gunstock

---

Your customers can now achieve the high-end look of Walnut at an attainable price point with the introduction of our new Gunstock Textured Laminate. Available on Herra and Gallio door styles with Thatch and Chocolate stained cabinet box options in Maple, Oak and Cherry.

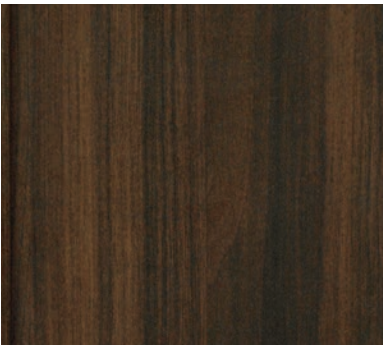

Gunstock Textured Laminate

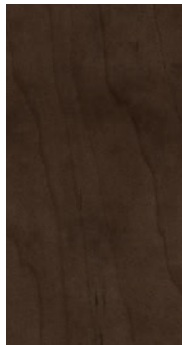

Thatch box color  
shown on Maple



Chocolate box color  
shown on Maple



# *icy avalanche linea nightfall*

---

Mimicking the brushed look of the Icy Avalanche Nightfall finish found in the Boutique Series, Icy Avalanche Linea Nightfall allows your customers to obtain a similar look in a lower cost laminate option. Available on the Herra and Gallio door styles with a coordinating Icy Avalanche cabinet box.

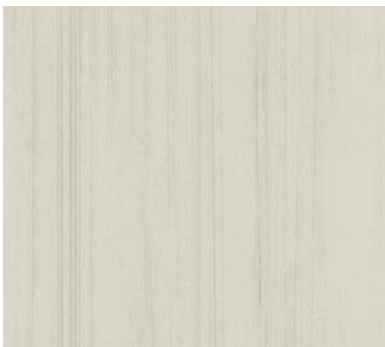

Icy Avalanche Linea Nightfall Laminate



Icy Avalanche  
box color



## *rustic hickory*

---

Rustic Hickory is now available in the Schrock Trademark Series! At once both rustic and modern, the wild grain variation apparent in Rustic Hickory showcases an honest appreciation for natural beauty.

Available in the Brinkman, Campbell, Edmond, Elston, Huxley, Ingalls, Lormand, Morgan, Pleasant Hill and Willet door styles.

# modifications

---

## Slab Top Drawer Front

DFS LBT, DFF5PCSLBT, and DFR5PCSLBT page 43

Use the Slab Top Drawer Front modification to create the space needed to install large profile drawer pulls on smaller drawer fronts, while maintaining the 5-piece look your customer loves on larger drawer fronts.

## Prepare Cabinet for Finished Bottom - Stacked Wall Cabinets

We are removing exceptions by allowing the PFINBTMB (Prepare Cabinet for Finished Bottom) modification on Stacked Wall cabinets. Affected SKUs: STW., STDW..2424 L/R, STWTC12.. L/R.

## Full Depth Shelf - Pantry Unit

All Pantry Top Units are available with the Full Depth Shelf modification to allow your customer to customize the cabinet to their preferred storage configuration. Affected SKUs: PTU\_\_ L or R and PTU\_

# construction

---

## New Universal Access Offering with Standard Toekick Height

We have replaced our Universal Design SKUs with a new Universal Access offering featuring a standard 4 1/2" toekick height. All Universal Access kitchen cabinets are 32 1/2" high, which meet ADA work surface height guidelines of 34" high when installed with a 1 1/2" thick countertop, while offering a more aesthetically pleasing appearance. Refer to the ADA kitchen guidelines for more details on design requirements.

## 3/8" Cabinet Tops, Bottoms and I-beam Braces

Our strength shows in our cabinet construction. Rated by KCMA to withstand the rigors of everyday wear and tear, your customer can rest assured that they will have a kitchen to last a lifetime. And as always, you can rely on Schrock to have your back with a limited lifetime warranty.

## New Office Three Drawer Bases

Previous Desk Drawer Bases (DDR\_\_2921 and DDR\_\_2924) have been replaced with new 3DB\_\_2921 and 3DB\_\_2924 featuring new frame openings and drawer front sizes in both full and partial overlay to align better with other cabinets and improve reveal consistency.

## Drawer Front Height Changes

Several drawer fronts are now taller to provide reveals more consistent with other doors and drawer fronts.

Full overlay 11" high lower drawer fronts: W2D\_\_

Partial overlay 9 1/2" high lower drawer fronts: W2D\_\_

Partial overlay 10 5/8" high lower drawer fronts: 3CDB36, 3DB\_\_, OCD\_\_DD, OCS\_\_DD, OMC\_\_DD, 6VSD\_\_, VDB\_\_, V3SD\_\_, and VSD\_\_

# *expanded sku offering*

---

Eliminating size gaps is a frequent designer request. And now, for a variety of products you are already familiar with, added sizes make incorporating them into designs effortless!

## **Microwave Wall Cabinets**

MW2436, MW2439, MW2442, MW2739, MW2742, MW3039 and MW3042 page 178

## **Under Counter Drawers**

UCD3318 and UCD3321 page 448, 496

## **Vanity Sink Base with False Panels**

VSB543221, VSB543421, VSB543218, VSB603218, VSB603221 and VSB603421 page 456 - 459

## **Vanity Sink Drawer Base with Six Drawers and False Panel**

6VSD573221FP and 6VSD573421FP page 492

## **Tall End Panel Skins**

TEPS1284WD page 519

# *hardware*

---

page 573 - 577

Now, one updated hardware collection spans across the Schrock enterprise, delivering the latest on-trend styles in today's most sought-after colors and finishes, including gold, chrome and black. See the complete hardware collection at [schrock.com/products/hardware](http://schrock.com/products/hardware).







# embellishments

A large variety of on-trend metal and wood embellishments are sure to bring a unique focal point to any design.

## Decorative Feet & Legs

Mid-Century Foot (MCFOOTS)

Square Legs with Metal Sleeve in 3", 4", and 5" widths

(\_SQLEG\_ \_-35, metal sleeves available in Gun Metal Gray, Wrought Iron and Satin Nickel)

Square Legs with Tapered Foot 2", 3" and 4" widths (SQLEGTAP\_)

Bungalow Leg in 3" and 5" widths (BUNLEG\_)

Gaelic Leg in 4.5" wide (GAELICLEG)

Island Leg with Tapered Sides (ISLEGTPRD)

## Corbels

Triad Corbel in 5", 9", and 12" heights (CORBELTRIAD\_)

Bauhaus Corbel in 9" and 12" heights (CORBELBAU\_ \_\_, available with Brushed Aluminum and Wrought Iron accents)

## Metal Shelf Supports

Industrial Bracket, Loop, in 8 7/8" and 12 7/8" depths

(BRACKETIND\_ \_\_, available in Stainless Steel, Gun Metal Gray, and Wrought Iron)

Industrial Bracket, Straight, in 8 1/2" and 12 1/2" depths

(STBRACKETIND\_ \_\_, available in Stainless Steel, Gun Metal Gray, and Wrought Iron)

Mid-Century Triangle Bracket, 12 3/4" deep (TRIBRKT\_ \_\_, available in Gun Metal Gray, Satin Nickel, Wrought Iron, and Stainless Steel)

## Corner Shelves

Modern Corner Shelf, 3/4" (MDCCRNSHLF)

Modern Corner Floating Shelf, 2 1/2" (MDFLCRNSHLF)



Pleasant Hill Maple Egret Paint

## *hoods & chimneys*

---

Wood hoods provide a focal point and an extra level of personalization for your customers. This launch includes wood hoods perfect for transitional or contemporary styles:

Simple Tapered Wood Hood (WHSMT\_ ) page 212

Simple Tapered Wood Hood with Corbels (WHSMTCB\_ ) page 212

Simple Wood Hood Chimney (WHSMC\_ ) page 212

Arch Flat Panel Wood Hood (WHAFP\_ ) page 206

Square Flat Panel Wood Hood (WHSFP\_ ) page 206

Straight Batten Wood Hood, 24" and 36" High (WHSBATTEN\_ \_24 and WHSBATTEN\_ \_30 ) page 216

Classic Square Wood Hood, 30" Wide (WHS30) page 204

Classic Wood Hood Chimney, 30" Wide (WHC30) page 206

# product offering

---

## Stacked Wall Blind Corner Cabinets

STWC\_ \_ page 148 - 151

Stacked Wall Blind Corner cabinets bring added design flexibility by foregoing the need to stack individual cabinets for simplified installation that results in fewer unsightly seams. When designing with stacked cabinets, have you ever had to change the design due to limited options for corner cabinets? The introduction of our new stacked corner cabinets makes it easy to design around a corner while maintaining cabinet alignment.

## Bookcase Width Expansion

W\_ \_30BC and W\_ \_48BC page 422 - 427

TBC\_ \_12 and TBC\_ \_18 page 428 - 435

The current popularity of designing with bookcases has prompted us to add 21", 27" and 33" widths, helping you create a customized look for your customers.

## New Widths for 12" and 15" High Wall Cabinets

W2112 L or R, W2412 L or R, W241224 L or R, W2115 L or R, W2415 L or R, W241524 L or R, W4215CS, W421524CS page 90 - 98

Introducing a single door version of the W2112, W2412, W2115 and W2415 SKUs and a two-door version of the W4215 to simplify cabinet stacking with more visually appealing results.

## Expansion of Wall Top Hinge Cabinet Sizes

WTH309, WTH369, WTH21924, WTH30924, WTH33924, WTH36924, WTH37924 page 88

WTH1812, WTH2112, WTH331224, WTH371224 page 90 - 94

WTH1815, WTH2115, WTH331524, WTH371524 page 96 - 99

WTH1818, WTH2118, WTH331824, WTH371824 page 100 - 103

WTH1821, WTH2121, WTH332124, WTH372124 page 106 - 109

Wall Top Hinge SKUs are now available in more sizes to make designing with this popular feature even easier! New 9" High Wall Top Hinge are perfect for use over a refrigerator, available in both standard depths and four widths from 30" to 37". Two WTH21924 cabinets can be used side-by-side to create a 48" wide design solution for use over large built-in refrigerators. New 18" and 21" wide WTH cabinets are ideal for stacking applications with four heights from 12" to 21". And new 33" and 37" widths in all current 24" deep WTH sizes help your design look sleeker and avoid the use of fillers.

## 27" High Wall Corner Cabinets

WC2427 L or R, WC2727 L or R, WC3027 L or R page 142

The introduction of 27" high Wall Corner Cabinets in 24", 27" and 30" widths provides your customers with a less expensive, more on-trend square blind corner solution.

## Base Corner Full Width Cabinets with Full Height Door

BCFW\_ \_FH L or R page 294

In order to achieve greater visual alignment in a blind corner design, Base Corner Full Width cabinets are now available with a full height door. This configuration provides a taller opening in the lower section for greater access to the cabinet interior. For increased visibility on 42" – 48" wide cabinets, add an installed motion-activated LED light with the LT1.BS modification.

## 39" Wide Vanity Sink Drawer Bases

2VSD3932\_ \_ and 2VSD3934\_ \_ page 476 - 479

VSD3932\_ \_DL or DR and VSD3934\_ \_DL or DR page 480 - 483

VSD3932\_ \_FP DL or DR and VSD3934\_ \_FP DL or DR page 484 - 489

No more sizing down to fit the available space with the new 39" wide Vanity Sink Drawer Bases. This popular cabinet can now be used in even more designs without compromising precious bathroom storage space!

## More Vanity Wall Hung Widths

VWH1523.521, VWH1823.521, VWH2123.521, VWH2423.521, VWH2723.521, VWH3323.521

VWH2D2423.521, VWH2D2723.521, VWH2D3323.521

VWH2D2423.521FP, VWH2D2723.521FP, VWH2D3323.521FP

page 500 - 503

The Vanity Wall Hung cabinet offering has more than doubled with new widths in most configurations for more design possibilities in this popular look. Our enhanced box construction features a full cabinet top and standard APC and FPEB for maximum structural integrity. See specification section for installation requirements and loading limits.

## 66" High Standard Utilities

U\_\_6612 L or R page 344

U\_\_6624 L or R page 344

U\_\_6624RT L or R page 358

Pair a new 66" high utility cabinet with a wall cabinet to accommodate designs taller than 96". When working in Cherry or Maple, hide the seam with a TEPS up to 120" high. Designing with a different species? Get creative with some interesting moulding options!

## Cabinet Cleaning Kit

CABCLEANKIT page 589

Take the guesswork out of cabinet cleaning with our new, all-natural citrus based cleaner. Tested on all of our cabinet finishes, we can confidently say it is safe for use on our top coats. Each kit includes a 16 ounce bottle of cleaner and a microfiber cloth for gentle cleaning of all wood and laminate cabinet surfaces.

## Base Pantry Pull-out with Tray Divider

BDP12 page 324

Introducing a new pantry pull-out option for easier access to traditionally hard-to-store items such as cookie trays, cutting boards, pizza pans, and sheet pans. This new 12" wide cabinet features a Smart Stop™ door-mounted tray divider pull-out. Also available in the Boutique Series.

## Wood Tiered Cutlery Expansion to 30" and 36" Widths

3DB30WTCD and 3DB36WTCD page 312

4DB30WTCD and 4DB36WTCD page 316

B30WTCD and B36WTCD page 238

B30RTWTCD and B36RTWTCD page 262

WTCD30 and WTCD36 page 580

In support of the wide drawer trend in the kitchen, new 30" and 36" wide versions of the Wood Tiered Cutlery Dividers provide tidy organization to any kitchen with an ideal spot for not just forks and spoons, but also larger utensils, knives, foil, plastic wrap, and more. Available both as an accessory and an installed option in all current versions of WTCD cabinets (3DB\_\_, 4DB\_\_, B\_\_, and B\_\_ RT).

## Single Oven Cabinets with Base Cabinet Lower Section

OSB\_24 and OSB\_24N page 384 - 387

Say goodbye to the undesirable reveal area around the oven. The new, smaller cut-out on our single oven cabinet offers a better fit for most standard single ovens. A base cabinet below the oven provides extra storage that aligns with flanking cabinets making this cabinet a win-win! All current OCS\_ versions remain available for when additional space is required for appliance cut-outs and trim kits.

## 1.5" Wide Box Column Filler

W1.5\_BCFP, B1.5\_BCFP, and T1.5\_BCFP page 513 - 515

To achieve a cleaner finished look, especially in smaller kitchens, new 1.5" wide Plain Box Column Fillers create enough space needed for design perfection without leaving any space unused.

## Parker Drawer Front Change

Parker is now standard with a 3/4" profiled slab drawer front and continues to offer the 5-piece drawer front with the DFR5PC option. The 1" raised profile drawer front has been discontinued.

## New Width for Three Drawer Base with Deep Drawer

3DBDD27 page 314

With the addition of a 27" wide Three Drawer Base with Deep Drawer, your drawer base options just got a little easier! The deep bottom drawer box is perfect for storing frequently used taller items, easily accessible with our Smart Stop™ drawer guides.

## Discontinuations

- Hickory species (Replaced by Rustic Hickory)
- Brookshire door style (Replaced by Galvyn)
- Reflection door style
- Hutton door style (Replaced by Kayes)
- Princeton door style (Replaced by Harwell)
- Lambswool, Lambswool with Amaretto Creme, Lambswool with Grey Stone, and Lambswool with Toasted Almond (last order date: May 29, 2020)
- Aluminum Frame Door Options:
  - White Powder Coat Finish with Frost Glass (ALFW)
  - Aluminum finish with Matching Center Panel (ALFM)
  - Brushed Stainless Steel Look with Matching Center Panel (ALFBSM)
  - Oil Rubbed Bronze Powder Coat Finish with Frost Glass (ALFOR)
- Cocoa Rice Paper, Cross Reeded, Ellington, Morisco and Strelli glass styles
- Tilt-Out Tray, Stainless Steel Modification (TOTSS) and Accessory (TOTSS10 - TOTSS31), slim versions remains available
- Utility Easy Access (UEAS\_ \_)
- Stacked Wall End Cabinets (STWEC\_ \_ , STWEC\_ \_ D)
- Embellishments:
  - 2SBARLEG, 4SBARLEG, CORBELCELT, CORBELCRBN, CORBELSCR6, CORBELSCR9, FFRC6X6, FRNLG, J3SPTRINGFIN, 3SPTRINGWV, JACANFOOT, JACANINSERTM, JACANTHUSLEG, JCELOVLY, JCORBELACAN10, JCORBELARTO, JCORBELCOS7, JCORBELOWD4, JCORBELSHKR3, JCORBELSHKR16, JCORBELTRADO, JFLUTELEG, JFLUTELEGL, JFLUTELEGT, JFRNCNTYFOOT, JFRNCNTYLEGT, JMADFOOT, JMISSINSERTM, JQUNANNELEG, JRDLEGL, JRDLEGT, JROPELEGS, JROPELEGSS, JROPELEGT, JSPLEGS, JSPLEGT, JSPTRINGCTR, JSQBARLEG3, JSQBARLEG3S, JSQISLLEG3S, JTILEACAN, JTILEMISSION, JTULIPLEG, JTULIPLEGT, JURNLEGT, JWEAVEFOOT, JWEAVEINSERTM, JWEAVELEG, JWEAVELEGL, JWEAVELEGT, RDLEG, ROSETTESCR
- Wall Decorative Shelves:
  - WCS2424, WS12, WS15, WS18, WS21, WS24, WS30, WS36
- Select pieces of hardware:
  - KNOBH06, KNOBH07, KNOBH10, KNOBH20, KNOBH23, KNOBH31, KNOBH32, KNOBH35, KNOBH37, KNOBH40, KNOBH43, KNOBH46, KNOBH54, KNOBH57, KNOBH58, KNOBH62, KNOBH65, PULLH08, PULLH11, PULLH30, PULLH34, PULLH36, PULLH38, PULLH39, PULLH41, PULLH42, PULLH44, PULLH45, PULLH47, PULLH51, PULLH52, PULLH53, PULLH55, PULLH56, PULLH59, PULLH60, PULLH61, PULLH64, PULLH66, PULLH70, PULLH71
- Wood Hoods:
  - Contemporary Straight (JWHCONSTR\_ \_ ), Island Arch (JWHIA\_ \_ ) and Island Square (JWHIS\_ \_ )
- Vanity Cabinets:
  - 2VSD57/603218, 2VSD57/603218FP, 2VSD57/603221, 2VSD57/603221FP, 2VSD57/603418, 2VSD57/603418FP, 2VSD57/603421, 2VSD57/603421FP
- LED Lighting SKUs:
  - PUCK24CW, FLEX36CW and RIGID24CW





## TABLE OF CONTENTS

Index by Description	A-E
Characteristics	1-3
12-Step Finishing Process	4
Policies	5
Door Styles	7-29
Premium Color Palette	30
Unfinished	31
Finish Techniques	31
Finish Availability	32-38
Construction Features	39
Modification/Upgrade Compatibility Chart	40
Construction Upgrades	41
Drawer Front Upgrades	42
Drawer Front Options	43
Drawer and Door Options	44
Custom Modifications	45-60
Door Modification/Specialty Doors	61-65
Glass Inserts	66-72
Cabinet Dimensions	73-82
Design Checklist	83
NKBA Guidelines	84-85
Smart Solutions™ Reference Chart	86-87
Wall Cabinets	88-221
Hearths	222-233
Base Cabinets	234-337
Universal Access Cabinets	338-343
Tall Cabinets	344-421
Office & Furniture Cabinets	422-449
Vanity Cabinets	450-507
Fillers	508-518
Panels & Skins	519-530
Wainscoting	532-533
Custom Panels & Applied Doors	534-536
Custom Hinged Doors	537-538
Moulding	539-550
Valances	551
Embellishments	552-566
Contemporary Embellishments	567-568
Shelves	569-570
Lighting & Lighting Accessories	571-572
Hardware - Decorative Knobs, Pulls, Faux Hinges	573-578
Accessories	579-585
Roll Tray Kits	586-588
Guide Kits and Parts	588
Stain, Paint, & Touch-up Tools	589
Hinges	590
Doors, Drawer Fronts, & Drawers	591
Parts	591
Stacked Moulding Kits	592-600
Agreements	601-604
Index by Code	605-606

Description	Code	Page Number
Abbe Foot	ABFOOT	560
Acanthus Light Rail Insert	JLRINSACAN	549
Acanthus Moulding	ACAM	543
Acanthus Ornament	ACO	552
Acanthus Overlay	ACOVLY	552
Add Toekick	ADDTK	56
All-plywood Construction	APC	41
Aluminum Frame Doors w/Frost Glass	ALF	61
Angled Corner Sink Front Bottoms	ACSFB	286
Angled Corner Sink Fronts	ACSF	284
Angled Corner Sinks	ACS	284
Angled Fluted/Plain Fillers	BLVDFF	513
Appliance Cut-out, Single	ACS	50
Arch Flat Panel Wood Hood	WHAFP	206
Arched Valance	AV	551
Art Corbel 9"	CORBELART9	563
Arts & Crafts Bracket	JBRACKETART	564
Asymmetrical Base Easy Reach	BER	298
Asymmetrical Base Easy Reach w/Adjustable Shelves	BERAS	298
Asymmetrical Easy Reach Wall Corners	ER	164
Asymmetrical Solid-wood Super Lazy Susan	SLSW	302
Asymmetrical Super Lazy Susan w/Chrome Rail	SLSR	302
Asymmetrical Super Susans	SLS	300
Authentic Ends	AUTHL, AUTHR	45
Back Panel Moulding	BPM	543
Back Skin, Interior	BP	520
Back Sockets	BKSOCKET	588
Baroque Leg	JBAROQUELEG	553
Base Bin Tray Pull-out Cabinets	BBTP	320
Base Box Column Pull-outs (Plain, Overlay)	BBCPO	326
Base Buffet Three Drawer	3DBB	310
Base Buffet Three Drawer w/Deep Drawer	3DBBDD	314
Base Built-in Microwave Cabinet w/Drawer	BBMWD	330
Base Cabinets	B	234-236
Base Cabinets Four Drawer	4DB	314
Base Cabinets Four Drawer w/Cutlery Insert Wood Organizer	4DB..CIW	316
Base Cabinets Four Drawer w/Wood Tiered Cutlery Divider Drawer	4DB..WTCD	316
Base Cabinets Four Drawer w/Wood Tiered K-Cup Drawer	4DB..KCUP	316
Base Cabinets Full Width w/Roll Trays & Swing-outs	BCFW..SP	294
Base Cabinets Three Drawer	3DB	310
Base Cabinets Three Drawer Corner	3CDB	304
Base Cabinets Three Drawer w/Deep Drawer	3DBDD	314
Base Cabinets Three Drawer w/Warming Drawer	3DB..WD	312
Base Cabinets Three Drawer w/Wood Tiered Cutlery Divider Drawer	3DB..WTCD	312
Base Cabinets Three Drawer w/Wood Tiered K-Cup Drawer	3DB..KCUP	312
Base Cabinets Two Drawer	2DB	306
Base Cabinets Two Drawer w/Drop-in Range	2DB..DR	310
Base Cabinets Two Drawer w/Drop-in Range & Warming Drawer	2DB..WD	310
Base Cabinets Two Drawer w/File Drawer	2DB..FD	306
Base Cabinets Two Drawer w/Pegged Dish Organizer	2DB..PDO	308
Base Cabinets Two Drawer w/Roll Tray	2DB..RT	308
Base Cabinets Two Drawer w/Roll Tray & Pegged Dish Organizer	2DB..RTPDO	308
Base Cabinets w/Full Height Doors	B..FH	240, 244
Base Cabinets w/Mixer Shelf	B..FHMIXSC	270
Base Container Organizer Pantry Pull-out	BCOPP	324
Base Corner Cabinets	BC	292
Base Corner Cabinets w/Pull-out	BC..PO	292
Base Corner Full Width Cabinets	BCFW	292
Base Corner Full Width Cabinets w/Curved Pull-out	BCFW..CPO	294
Base Corner Full Width Cabinets w/Pull-out	BCFW..PO	294

Description	Code	Page Number
Base Corner Full Width, Full Height	BCFW..FH	294
Base Corner Inside	B..CIA	306
Base Corner Outside	B..COA	304
Base Corner Peninsula	BCP	334
Base Corner Peninsula, Full Height Door	BCP..FH	334
Base Drawer Cabinets	DB	306-316
Base Drop-in Range Cabinet	B..DR	328
Base Easy Access Cabinets	BEAS	246
Base Easy Reach	BER	296
Base Easy Reach w/Adjustable Shelves	BERAS	298
Base End Cabinet	BEC	306
Base End Shelves	BQRES	334
Base Full Height w/Tray Divider	TD..FH	270
Base Lazy Susan Corner w/Center Hinge Door	BLS	296
Base Lazy Susan Corner w/Revolving Door	BLS..DR	296
Base Message Center	BMC	326
Base Microwave Cabinets	BMW	332
Base Microwave Cabinets w/Deep Drawer	BMWDD	330
Base Microwave Cabinets w/Drawer	BMWD	330
Base Microwave Cabinets w/Roll Tray	BMW..RT	332
Base Mixer Kit	MIXKITFHSC	579
Base Open Cabinets	BOC	336
Base Open Cabinets w/Drawer	BOD	336
Base Ovens	BO	328
Base Pan Storage	BPS	579
Base Panel w/Filler Attached & Authentic End	BEP..AEL, AER	527
Base Pantry Pull-outs	BPP	324
Base Paper Towel Cabinet	BPT	234
Base Paper Towel Cabinet Full Height	BPT..FH	240
Base Paper Towel Cabinet w/Wastebasket	BPT..WB	318
Base Paper Towel Cabinet w/Wastebasket Full Height	BPT..WBFH	318
Base Pots & Pans Pull-out	BPPP	266
Base Rotating Deep Bin	BRDB	302
Base Spice Drawer	BSD	322
Base Transition Cabinets	BTC	304
Base Tray Divider Pantry Pull-out	BTDP	324
Base Utensil Pantry Pull-out	BUPP	324
Base Utensil Pantry Pull-out w/Knife Block	BUPPKB	326
Base Wastebasket	BWB	316
Base Wastebasket Full Height	BWB..FH	318
Base Wastebasket Lids	BWBFHLID, BWBLID	579
Base Wine Cubby	BWC	322
Base w/Can and Wine Bottle Pull-outs	B..CWP	268
Base w/Food Storage Container Organizer	B..FSCO	266
Baseboard Moulding	BBM	546
Baseboard - Sculpted	BBMSC	546
Baseboard - Shaker	BBMSH	546
Baseboard - Swooped	BBMSW	547
Bases w/Cutlery Insert	B..CIW	236
Bases w/Drawer & Lid Organizer & Roll Trays	B..RTLO	264
Bases w/Full Height Doors & Roll Trays	B..FHRT	258
Bases w/Lid Organizer & Roll Trays	B..FHRTLO	264
Bases w/Roll Trays	B..RT	256
Bases w/Roll-out Tray Divider	B..TDRO	270
Bases w/Tray Dividers	TD	270
Bases w/Wood Cutlery Insert & Roll Trays	B..RTCIW	260
Bases w/Wood Tiered Cutlery Divider Drawer	B..WTCD	238
Bases w/Wood Tiered Cutlery Divider Drawer & Roll Trays	B..RTWTCD	262
Bases w/Wood Tiered K-Cup Drawer	B..KCUP	240
Bases w/Wood Tiered K-Cup Drawer & Roll Trays	B..KCUPRT	264
Bauhaus Corbel	CORBELBAU	566
Biometric Secured Drawer	DRWSEC	52
Bookcases Tall	TBC	428-430
Bookcases Tall w/Doors	TBCD	432-434
Bookcases Wall Furniture	WFBC	424
Box Column Fillers (Wall, Base, Tall)	BCF	513-518

Description	Code	Page Number
Braided Moulding	BRAIDM	543
Broom Clip	BRMCLP	579
Buffet Leg	JBUFFTELEG	553
Bumper Pads	BUMPERPADS	591
Bungalow Leg	BUNLEG	553
Cabinet Box Only	CBO	47
Cabinet Care Kit (PURE&SIMPLE™)	CABCLEANKIT	589
Cabinet Case Only	CCO	47
Cabinet False Panel	CFP	47
Cabinet Frame Only	CFRMO	60
Cabinet Front Only	CFNTO	60
Cabinet Panel Edge Moulding	CPE	544
Cabinet w/No Door, w/Drawer	CND	47
CabMat™	CABMAT	579
CabMat™	CMAT	52
CabMat™ Vanity	CABMATV	579
Canopy Arch Wood Hood	JWHCA, WHCA	208
Canopy Square Wood Hood	JWHCS, WHCS	214
Cap Moulding	CAPM	548
Celtic Insert	INSERTCELT	543
Celtic Light Rail Insert	JLRINSCFLT	549
Celtic Rosette	ROSETTCELT	553
Classic Arch Wood Hood	WHA	204
Classic Square Wood Hood	WHS	204
Classic Tall Crown Moulding	CLTCROWN	539
Classic Wood Hood Chimney	WHC	206
Contemporary Light Rail	JINSERTLRC	548
Cooking Utensil Divider	CUDD	580
Corner Door Cabinets	CD	184
Corner Fillers	CF	508
Cornice Tall Crown Moulding	COTCROWN	539
Cosmo Corbel, 13" Large	JCORBELCOS13	563
Cosmo Corbel, 13" Large Deep	JCORBELCOS13D	563
Cosmo Foot	JCOSFOOT	560
Cosmo Leg	JCOSMOLEG	554
Countertop Edge Moulding (Contemporary & Traditional)	CCM, TCM	544
Country Sink Base w/CabMat™	CNTYSB..CM	288
Country Sink Base w/Short Apron	CNTYSB..SA	288
Country Sink Bases	CNTYSB	286
Cove Corbel	CORBELCOVE	563
Cove Crown Moulding	COVECROWN	539
Craftsman Foot	JCRAFTFOOT	560
Craftsman Open Bracket	JCORBELCRAFTO	565
Cross Grain Veneer Back Skin 1/4" Panels	BP..CRSGR	521
Custom Doors, No Hinge Routing	DADOOR	535
Custom Doors w/Hinge Routing	DOOR	537
Custom Doors w/Hinge Routing, Slab Styles	DOORSLAB	538
Cut-for-glass Doors	CG, CG.BTM, CG.TOP	62
Cutlery Dividers	CIW, WTCD	580
Decorative Appliance Panels	DAPNL	534
Decorative Door Panel Kits, Base End	BED	529
Decorative Door Panel Kits, Tall End	TED	529
Decorative Door Panel Kits, Wall End	WED	530
Decorative Split Turnings 3"	J3SPTRING	562
Decorative Split Turning End	SPTRINGEND	562
Decorative Split Turning Reed	SPTRINGREED	562
Decorative Split Turning Rope	SPTRINGROPE	562
Decorative Split Turning Spool	SPTRINGSPPOOL	562
Deep Roll Tray	DRT	53
Dentil Moulding	MDENTIL	543
Desk Door Drawer Bases	DDO	436
Desk Double File Drawer Bases	DDFD	440
Desk Easy Reach	DER	442
Desk File Drawer Bases	DFD	440
Desk Three Drawer Bases	3DB	438
Desk Wastebasket Full Height Bases	DWB..FH	440
Diagonal Base Cabinet w/Full Height Door	DAB..FS	296

Description	Code	Page Number
Diagonal Base Cabinet w/Full Height Door & Super Lazy Susan	DAB..SLS	296
Diagonal Corner Moulding	DCM	549
Diagonal Wall Cabinets	DW	152-154
Diagonal Wall Cabinets w/Lazy Susan	DW..S	154
Diagonal Wall Cabinets w/Lower Door	DW..D	156
Diagonal Wall Cabinets w/Lower Door & Lazy Susan	DW..DS	156
Diagonal Wall Peninsula Cabinets	DW..P	160
Door Panel - Solid Reverse Raised	DPSRR	44
Drawer Front Flat 5-piece	DF5PC	42
Drawer Front Flat 5-piece w/Slab Top	DF5PCSLBT	43
Drawer Front Raised 5-piece	DFR5PC	42
Drawer Front Raised 5-piece w/Slab Top	DFR5PCSLBT	43
Drawer Front Slab	DFSLB	42
Drawer Front Slab Top	DFSLBT	43
Drawer Guide Kits	DGK	588
Drawer Guide Spacer Block	SPACERBLK	588
Ductless Conversion Kit	CONVERSION	220
Easy Reach Wall Corner Cabinets	ER	162
EasyTrax™	ET	53
Edgebanding	EDGEBAND	581
Egg & Dart Moulding	EGD	543
End Extended Back	EXBKL, EXBKR	49
End Panel/Base	BEP	522
End Panel/Base Lazy Susan	BLSBEP	523
End Panel/Tall	TEP	523
End Panel/Vanity Base	VBEP	524
End Panel Skins/Base	BEPS	519
End Panel Skins/Tall	TEPS	519
End Panel Skins/Wall	WEPS	520
English Bar Column	ENGBARCOLUMN	554
English Country Leg	JENGCNTYLEG	554
English Island Column	JENGLSICOLUMN	554
Estate Leg	JESTATELEG	555
Estate Leg, Small	JESTATELEGS	554
Estate Leg Split, Small	JESTATELEGSS	555
Extended Stile	EXL, EXR	50
Exterior Shelves	ES	569
EZ-Org™ Modular Pull-out Racks	EZORG	583
Face Frame and Door on End	FFDL, FFDR	45
False Panel Clips	FALSEPNLCLIP50, PFALSEPNLCLIP50	588
Filler Return	F..R	508
Fillers	F, TF	508
Finished Back Skins	BP	520
Finished Ends	FB	45
Flat Scribe Moulding	SM	544
Floating Island Bases	FIC	322
Floating Island Bases without Top	FICNT	322
Floating Shelves	FS	569
Flush Toekick	FTK, FTK.FNT.P, FTK.P	56
Flush Toekick Arch	FTKAV, FTKAV.FNT.P, FTKAV.P	56
Flush Toekick Furniture	FTKFV, FTKFV.FNT.P, FTKFV.P	56
Fluted/Beaded Fillers	FBF	513
Fluted Leg, Small	JFLUTELEGS	555
Fluted Leg Split, Small	JFLUTELEGSS	555
French Country Leg	JFRNCNTYLEG	555
Full Depth Interior Shelves	SK	570
Full Depth Shelf	FD	52
Full Overlay Crown	FOLCROWN	539
Furniture Drawer Window Bench	FDWB	444
Furniture Drawers	FD	442
Furniture Finished Plywood Ends	FPFB	45
Furniture Valance	FV	551
Gaelic Leg	GAELICLEG	556

Description	Code	Page Number
Glass Shelf Kits	JGSK	570
Hardware - Decorative Knobs, Pulls, Faux Hinges	HINGEFH, KNOB, PULL	573-578
Hearth Liner	HL	232
Hearth Mantels	HM	230-232
Hearth Piers	HP.21	226
Hearth Piers w/Pull-out	HPP.21	228
Hearth Shelf	HS	232
Heat Shields	ANGLHEATSHIELD, ANGLHSHIELDSS, STRTHEATSHIELD, STRTHSHIELDSS	581
Hinge Angle Restriction Clip	HINGERESCLIP, RESCLIPQR	590
Hinge Shim	HINGESHIM	590
Hinges	HINGE	590
Increased Depth	ID	48
Industrial Bracket, Loop	BRACKETIND	567
Industrial Bracket, Straight	STBRACKETIND	568
Insert Crown	INSCROWN	539
Inside Corner Moulding	ICM	549
Installed Roll Tray	RT	53
Inverted Frame	INVFRM	51
Island Leg	ISLLEG	556
Island Leg Tapered	ISLEGTPRD	556
K-Cup Insert	WBCPOKCUP	581
Large Corbel	LGCORBEL	563
Large Outside Corner Moulding	LOSC	550
Large Shaker Crown	LSHAKER	540
Large Square Foot	LGSQFOOT	560
Large Straight Angle Crown Moulding	LSACROWN	540
Lazy Susan Pull-out	LSP	302
Library Moulding	LBRM	544
Lid Organizers	LO, LO24DP	581
Lidstay	LIDSTAY, LIDSTAYHD	590
Light Baffle Moulding	LB	548
Light Installed Battery Strip	LTI	53
Light Rail Moulding	LRM	548
Lighting & Lighting Accessories	—	571-572
Lille Foot	LIFOOT	561
Linear Tapered Wood Hood	JWHL	206
Linen Closet	LC	498
Linen Closet Hamper Liner	LCHAMPERLNR	581
Linen Closet w/Removable Hamper	LCRH	498
Linen Storage Cabinets	LT	498
Loose Toekick	TKP	58
Madeline Foot	JMADEFOOT	560
Matching Interior Plywood	MIP	46
Medicine Cabinets (Single & Tri-View)	MC, TV	506
Medium Straight Angle Crown Moulding	MSACROWN	540
Metal Feet	FOOTMETAL	567
Metro Bar Column	METBARCOLUMN	556
Metro Island Column	METISLCOLUMN	556
Metropolitan Foot	JMETROFOOT	560
Mid-century Foot, Short	MCFOOTS	561
Mid-century Triangle Bracket	TRIBRKT	567
Mirror Frame Moulding	WMF	544
Miscellaneous Parts	BRKOFFSCREW, BUMPERPADS, INSTALLSCR, INSTALLSCREWS, MC16HDW/WCATCH, PDM, RETCLIP.BAG, SHELFPEGS, SHELFPEGSCTR, TVHDW/WCATCH	591
Mission Corbel 6"	CORBELMIS6	564
Mission Corbel 9"	CORBELMIS9	564

Description	Code	Page Number
Mission Leg	DLEMISSION	557
Mission Light Rail Insert	JLRINSMIS	549
Mission Rosette	ROSETTEMIS	552
Modern Corner Floating Shelf	MDFLCRNSHLF	569
Modern Corner Shelf	MDCCRNSHLF	569
Modified Full Overlay	MFO	44
Mullion Doors	MD, MD.BTM, MD.TOP	63
Mullion Doors, Prairie	PRMD	65
Mullion Doors, Shaker	SHMD	64
Ogee Edge Moulding	OGEEM	544
Old World Corbel 5"	CORBELWD5	564
Old World Corbel 7 1/2"	JCORBELWD7	564
Outside Corner 135° Moulding	OC135	550
Outside Corner Moulding	OCM	550
Oven Cabinets Double	OCD	398-400
Oven Cabinets Double w/Drawer	OCD..DD, WD	402-406
Oven Cabinets Double w/Drawer & Extended Opening	OCD..WDE	408
Oven Cabinets Single	OSB	384-386
Oven Installation Kit	OCINSTALLKIT	582
Oven Microwave Cabinets	OMC	412-414
Oven Microwave Cabinets w/Drawer	OMC..DD, WD	416-420
Oven Microwave Combo Cabinets	OCS	388-390
Oven Microwave Combo Cabinets w/Drawer	OCS..DD, WD	392-396
Overlay Fillers	OL	509
Overlay Fillers for Modified Full Overlay	OL..MFO	509
Panels w/Filler Attached	BEPE, TEP, WEP	525-528
Pantry Top Units	PTU	372
Pantry Top Units w/Pull-out	PTUP	374
Pantry Top Units w/Shelves	PTUS	370
Pantry Units	PY	378
Pantry Walk-Through	PWT	382
Pegged Dish Organizer	PDO, PDOPOSTS	582
Peninsula	P	60
Plinth Block	PLBLOCK	561
Plinth Block Filler 3"	FFP, BFPC	553
Plinth Block Filler 6"	FFP	553
Plywood Ends	PE	41
Pots & Pans Organizer Bases w/Drawer	B..PS	264
Pots & Pans Pull-out	PPP	582
Power Pods	JPWRPOD	582
PowerGlide™ Compact Drawer Outlet	DRWPWR	54, 582
Prepare Cabinet for Finished Bottom	PFINBTMB	49
Push to Open Wastebasket	PTOWB	54
Quarter Round Moulding	QRM	550
Quattro Dimming Receiver	QDIMREC	572
Quattro Wall Controller	Q4ZONECON	572
Raised Panel Arch Valance	JRPV	551
Recessed Island Toekick	RECTKALL	58
Recessed Panel Arch Valance	JRCPV	551
Recessed Toekick on Back or Side	RECTKBK, RECTKL, RECTKR	58
Reduced Depth	RD	48
Removable Vanity Sink Base	RVWS	342
Roll Tray Kits	RT	586
Roll Tray Kits Deep	DRT	586
Roll Tray Plug In Bracket	RTBKXSP	588
Rope Leg	JROPELEG	557
Rope Moulding	RPM	543
Rosette (Traditional)	TROSETTE	552
Rosette 3"	FFRC, BFRC	552
Scalloped Valance	SV	551
Scooped Drawer	SCPDRW	44
Segmented Super Susan	SSS	298
Shaker Corbels	JCORBELSHKR	565
Shaker Crown Moulding	SHKRCRM	540
Shelf Pull-down	SHLFPD	583
Shelf Support Bracket	SHELFBRKTSN	568
Shiplap Straight Wood Hood	JWHSHIPSTR	208

Description	Code	Page Number
Shiplap Straight Wood Hood w/Corbels	JWHSHPSTRCB	208
Shiplap Tapered Wood Hood	JWHSHIPT	210
Shiplap Tapered Wood Hood w/Corbels	JWHSHIPTCB	210
Shiplap Wood Hood Chimney	JWHSHPCH	210
Shoe Moulding — Convex Inside Corner	SHM	550
Simple Tapered Wood Hood	WHSMT	212
Simple Tapered Wood Hood w/Corbels	WHSMTCB	212
Simple Wood Hood Chimney	WHSMC	212
Single Bead Edge Moulding	SBF	545
Single Bead Moulding	SBM	545
Single Bead Pilaster	SBP	545
Single Door Medicine Cabinet	MC	506
Single Outlet Cover	JSOC	566
Single Rocker Plate	JSRC	566
Sink Base Caddy	SBCADDY	582
Sink Base Corner	SBC	290
Sink Base SuperCabinet™	SB..S	280
Sink Base SuperCabinet™ w/CabMat™	SB..SCM	280
Sink Base SuperCabinet™ w/Caddy	SB..SCDY	280
Sink Base SuperCabinet™ w/Tilt-out Trays	SB..STS	280
Sink Base SuperCabinet™ w/Tilt-out Trays & CabMat™	SB..STSCM	282
Sink Base SuperCabinet™ w/Tilt-out Trays & Caddy	SB..STSCDY	282
Sink Base w/CabMat™	SB..CM	272
Sink Base w/Caddy	SB..CDY	272
Sink Base w/Tilt-out Trays & CabMat™	SB..STCM	276
Sink Base w/Tilt-out Trays & Caddy	SB..STCDY	278
Sink Bases	SB	272-276
Sink Bases w/Drawers Below	SB..D	282
Sink Bases w/Tilt-out Trays	SB..ST, SB..CSST	276, 278
Sink Front Bottoms	SFB	284
Sliding Towel Rack	STR	583
Small Corbel	SMCORBEL	563
Small Cove Crown Moulding	SMCOVECROWN	541
Small Crown Moulding	SCM	541
Small Light Rail Moulding	SMLR	548
Small Scribe Moulding	SSM	545
Snack Bar Support 11 1/4"	SBS	564
Soffit Filler Moulding	SFM	542
Soffit Trim Moulding	TSTM	545
Solid-wood Crown Moulding	SWCRM	541
Solid-wood Large Crown Moulding	SWLCRM	541
Solid-wood Super Lazy Susan	SLSW	300
Solid-wood Tall Crown Moulding	SWTCRM	542
Solid-wood Victorian Crown Moulding	SWVCRM	542
Space Fillers	S96	509
Special Size Vanity	MV	496
Spice Rack Pull-down	SPD	583
Spice Racks	SRCH	583
Spool Leg	SPLEG	557
Spool Leg Split, Small	JSPLEGSS	557
Square Bar Leg	JSQBARLEG	558
Square Corner Sinks	CS	284
Square Flat Panel Wood Hood	WHSFP	206
Square Foot	JSQFOOT	560
Square Foot, Split	JSQFOOTS	561
Square Island Leg	JSQISLLEG	557
Square Island Leg, Metal Sleeve	SQLLEG	558
Square Leg w/Tapered Foot	SQLEGTAP	559
Stacked Diagonal Wall Cabinets	STDW	158
Stacked Wall Cabinets	STW	136-140
Stacked Wall Corner Cabinets	STWC	148
Stacked Wall Transition Cabinets	STWTC	176
Stain & Paint	QUARTCOLOR, SSC	589
Starter Moulding	STR8	542
Starter Moulding, Shaker	STRS	542
Straight Angle Crown Moulding	SACROWN	540

Description	Code	Page Number
Straight Batten Wood Hood	WHSBATTEN	216
Straight Valance	VV	551
Super Susans	SLS	300
Super Susans w/Chrome Rail	SLSCR	300
SuperCabinet™, 30"	BSC30PR, R, RP, RS, SR	248
SuperCabinet™, 36"	BSC36PRP, PRS, SRP, SRS	252
SuperCabinet™ Gourmet	BSCG	250, 254
SuperCabinet™ Version 2, 30"	BV2SC30PR, RP, RS, SR	250
SuperCabinet™ Version 2, 36"	BV2SC36PRP, PRS, SRP, SRS	254
Super Lazy Susans w/Chrome Rail	SLSCR	300
Tablet Holder	TABLEHLDR	583
Tall Built-in Microwave Cabinet	TBMWB	410
Tall Crown Moulding	ATCROWN	540
Tall Panel w/Filler Attached & Authentic End	TEP..AEL, AER	528
Tall Pantry Pull-outs	TPP	374
Tapered Leg	TAPLG	561
Tapered Wood Hoods	TWH	218
Tilt-out Trays, Plastic	TOT	584
Tilt-out Trays, Stainless Steel Slim	TOTSSS	54, 584
Toeboards	TB	547
Toekick Cap	TKC	547
Toekick Drawer	DRWTK	59
Toekick Vacuum	TOEKICKVAC	583
Toekick Tulip Foot	TKTLFOOT	561
Touch Latch	TOUHLATCH	567
Touch-up Tools	GLAZEPEN, MTUK, TUK	589
Traditional Light Rail	JINSERTLRT	548
Tray Divider, Chrome	CTDK	584
Tray Divider Kit	TDKIT	584
Tray Divider Roll-out Kit	TDRO	584
Tray Dividers	TD	55
Triad Corbel	CORBELTRIAD	565
Triple Bead Edge Moulding	TBEM	545
Triple Bead Pilaster Moulding	TBP	546
Tri-View Medicine Cabinets	TV	506
Truss Metal Corbel	CORBELTRSS	567
Tulip Foot	TLFOOT	561
Under Counter Drawers	UCD	448, 496
Under Panel Moulding	UPM	546
Universal Access Base Cabinets	B	338
Universal Access Base Microwave w/Deep Drawer	BMWD..DD	340
Universal Access Desk Leg	VDL..WD	340
Universal Access Sink Base Cabinets	SB	338
Universal Access Sink Base Cabinets w/Tilt-out Trays	SB..ST	338
Universal Access Super Lazy Susan	SLS	340
Universal Access Three Drawer Base Cabinets	3DB	340
Urn Leg	JURNLEG	559
Utility Cabinets	U	344-356
Utility Cabinets w/Roll Trays	U..RT	358-364
Utility Organizer Cabinets	UOC	366
Utility Organizer Drop Zone Cabinet	UOCDZ	368
Utility Storage w/Pantry Pull-out	US	376
Utility Storage w/Pantry Pull-out and Pot and Pan Rack	US..PP	376
Valance Top Rail	TVRAV, TVRFV, TVRVW	51
Valley Forge Moulding	VFR	548
Vanity Angle Corner Sink Front	VACSF	494
Vanity Angle Corner Sink Front Bottoms	VACSFBB	494
Vanity Base Easy Reach	VER	466
Vanity Base Wastebasket	VBWB	472
Vanity Bases	V	450-454
Vanity Chrome Roll-out Rack	VCRR	584
Vanity Desk Legs	VDL	528
Vanity Door Drawer Bases	VB	464
Vanity Drawer Bases	VDB	468
Vanity Four Drawer Bases	4VDB	472

Description	Code	Page Number
Vanity Grooming Pull-out	VGPO	474
Vanity Hamper	VH..FH	496
Vanity Hamper w/Drawer	VBH	498
Vanity Mirror	VM	506
Vanity Mirror w/Side Pull-outs	VMP	506
Vanity Pull-out	VP	474
Vanity Sink Bases w/False Drawer Fronts	VSB	456-458
Vanity Sink Bases w/U-Shaped Roll-out Tray	VSB.....U	460
Vanity Sink Bases w/Wastebasket	VSB.....WB	460
Vanity Sink Bases SuperCabinet™ w/Tilt-out Trays	VSSB.....ST	460
Vanity Sink Bases SuperCabinet™ w/Tilt-out Trays & Wastebasket	VSSB.....STWB	460
Vanity Sink Drawer Bases	VSD	476-486
Vanity Sink Drawer Bases w/Eight Drawers	VSD	494
Vanity Sink Drawer Bases w/Eight Drawers & False Panel	VSD..FP	494
Vanity Sink Drawer Bases w/Six Drawers	VSD	490
Vanity Sink Drawer Bases w/Six Drawers & False Panel	VSD..FP	492
Vanity Sink Three Drawer Bases	VS3D	488
Vanity Utility Cabinets	VU	500
Vanity Wall Cabinets	W	504
Vanity Wall Hung Cabinets	VWH	500
Vanity Wall Mirror Cabinets	VWM	504
Vanity Wall Sink	VWS	342
Vanity Wall Towel Bar	VWTB	504
Vanity Wastebasket	VWB	472
Void Toekick	VTK	59
Wainscoting	WAIN	532
Wall Appliance Garage Door	WAGD	184
Wall Appliance Garage Vertical-Lift Door	WAGVLD	184
Wall Base Double Door Cabinets	WB	246
Wall Base Single Door Cabinets	WB	244
Wall Box Column Pull-outs (Plain, Overlay)	WBCPO	186
Wall Box Column Pull-outs w/K-Cup (Plain, Overlay)	WBCPOKCUP	188
Wall Built-in Microwave Cabinets	WBMW	180
Wall China Display Cabinets	WCD	198
Wall China Display Cabinets w/Doors	WCD	198
Wall Corner Cabinets	WC	142-146
Wall Corner Inside	W..CIA	166
Wall Corner Outside	W..COA	166
Wall Double Door Cabinets	W	90-126
Wall Easy Access Storage Cabinets	WEAS	128
Wall End Cabinets	WEC	168
Wall Message Center	WMC	204
Wall Microwave Cabinets	MW	178
Wall Open Cabinets	WOC	194-196
Wall Organizers	WO	202
Wall Quarter Round End Shelves	WQRES	170-172
Wall Refrigerator Cabinets	W	92
Wall Refrigerator Pull-out	W..PO	104, 110, 114
Wall Refrigerator Vertical-Lift	WVL	104, 110
Wall Shelf Pull-down	W..SHLFPD	192
Wall Single Door Cabinets	W	90-126
Wall Spice Drawers	WSD	202
Wall Spice Pull-down	W..SPD	190
Wall Spice Pull-out	WSP	190
Wall Spice Rack Cabinets	WSR	192
Wall Susan Kits	WSK	585
Wall Three Drawer Cabinets	W3D	134
Wall Top Hinge Angle Restriction Clips	WTHRESCLIP	590
Wall Top Hinge Cabinets	WTH	88-108
Wall Transition Cabinets	WTC	174
Wall Two Drawer Cabinet	W2D	128, 132
Wall Vertical-lift	WVL	102-110
Wall Wine Cubbies	W	202
Wall Wine Racks	WNR	200

Description	Code	Page Number
Weave Light Rail Insert	JLRINSWEAVE	549
White Laminate Interior	WLI	46
Wide Scribe	WSCRIBE	546
Window Casing—Traditional	WCT	547
Wine Glass Holders	WGH	585
Wine Storage Cabinet	WSC	200
Wood Hood Blowers	BLOWER, TWHBLOWER	218
Wood Tiered K-Cup Drawer	KCUP	581
Wood Tops, Four Sided	4TWT	448
Wood Tops, One Sided	1TWT	444
Wood Tops, Three Sided	3TWT	446
Wood V-grooved Beaded Skin 1/4" Panels	BP..VG	521
Wood V-grooved w/Triple Beaded Front 3/4" Panels (Base, Tall, Wall)	BEP, TEP, WEP..VG	528

## CHARACTERISTICS OF WOOD TYPES

No matter which species you choose for your new kitchen or bath cabinetry, please keep in mind that no two pieces of wood are exactly the same. Stains are likely to exaggerate the difference between open and closed grains and other markings in wood. Grain variation and color change should be expected. As hardwood ages, it will darken when exposed to different types of light. Color differences or changes in wood can also be caused by exposure to harsh chemicals, extreme heat or moisture. Additionally, wood species exhibit other defining characteristics, such as mineral deposits/streaks, knots, sap runs, pin holes and wormholes. These markings make the wood unique and contribute to its enduring beauty.



**Alder** has a straight fine textured grain similar to Cherry and Maple. Although classified as a hardwood, it is moderately light in weight and considerably softer than other species. Therefore, care must be taken as it will dent and mar easily. Alder may exhibit grain and color variations, sapwood can be distinguishable from the heartwood, tight pin knots are sometimes present.



**Cherry** is characterized by its red undertones, but may vary in color from white to a deep, rich brown. Cherry is a close-grained wood with fairly uniform texture, revealing pin knots and curly graining. All wood will age with time and the finish will darken. This is especially true for Cherry. This is a sought-after quality in Cherry cabinetry, and those who select it expect this evolution.



**Maple** is a close-grained hardwood that is predominately white to creamy-white in color, with occasional reddish-brown tones. While Maple typically features uniform graining as compared to other wood species, characteristic markings may include fine brown lines, wavy or curly graining, bird pecks and mineral streaks. These traits are natural and serve to enhance Maple's natural beauty.

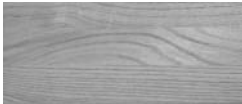

**Oak** is a strong, open-grained hardwood that ranges in color from white to pink and reddish tones. Streaks of green, yellow and even black may appear due to mineral deposits. Oak may also contain wormholes and wild, varying grain patterns. This distinct graining is considered a desirable quality.

## CHARACTERISTICS OF WOOD TYPES (cont'd)



**Rustic Alder** is characterized by its light brown and reddish undertones and may contain a variety of pin holes, open and closed knots of various sizes and colors, small cracks, bird pecks, mineral streaks, and grain variation. Some knots may have small holes through the panel. Larger holes will not be filled. In addition, the wood will contain color difference caused by variations in minerals found in the soil, creating visible mineral tracks.

**Sound Closed Knot** (not moveable) – Expected up to approximately 3” in diameter

**Sound Knot with Cracks** – Expect sound knots with open cracks up to approximately 1” in length

**Open Knot** (through door) – Expected with open area up to approximately 3/4” in diameter

Note: 3/4” diameter is about the size of a penny. Holes created by open knots pass completely through the door and are desirable for this rustic look.

**Unsound Knot** (moveable core) – Not to be expected

**Knot Cluster** (cluster of tight sound knots) – To be expected

**Worm Holes/Pin Holes** (can go through the door) – Can be expected up to approximately 1/4” in diameter

**Worm Tracks** – Can be expected in sizes up to approximately 1/8” wide by 8” long

**Rustic Hickory** is a strong, heavy hardwood known for distinctive graining patterns. Color will vary from nearly white to dark brown, with wild flowing grain patterns and dramatic color variations. Rustic Hickory can have a fine uniform grain to large knots appearing black and brown in color of various shapes and sizes, sapwood, mineral and some checking. Doors, drawer fronts, and selected trim items will feature rustic characteristics. Other areas of the product will utilize standard Hickory.



**Sound Closed Knot** (not moveable) – Expected up to approximately 3” in diameter

**Sound Knot with Cracks** – Expect sound knots with open cracks up to approximately 1” in length

**Open Knot** (through door) – Expected with open area up to approximately 3/4” in diameter

Note: 3/4” diameter is about the size of a penny. Holes created by open knots pass completely through the door and are desirable for this rustic look.

**Unsound Knot** (moveable core) – Not to be expected

**Worm Holes/Pin Holes** (can go through the door) – Can be expected up to approximately 1/4” in diameter

**Worm Tracks** – Can be expected in sizes up to approximately 1/8” wide by 8” long

## CHARACTERISTICS OF MDF

MDF (Medium Density Fiberboard) is an engineered wood product that is composed of wood fibers and resin that are then compressed to create a smooth uniform surface with a consistent core. Painted MDF eliminates the appearance of naturally occurring wood characteristics such as grain patterns, knots or mineral streaks, and is more resistant to warping, expanding and contracting due to environmental changes than solid hardwoods. Doors, drawer fronts, and additional facings may consist of other hardwood components.



## CHARACTERISTICS OF GLAZING/PAINT

### Flooded Glazes

A professional layer of glaze can add another layer of beauty to your cabinets. First, our craftsmen apply a wood toner, which accentuates the grain's natural attributes. We then add the glaze, by hand, adding depth, dimension and an understated sheen that's guaranteed to endure.

- Glazing will range from a consistent, even appearance to varied coverage.
- You should expect the result to yield a subtle to dramatic look based on the complexity of a cabinet door's design, as glaze may collect in the corners and grooves.
- Printed materials and online, electronic presentations can only do so much. It's important to both see and touch actual finished samples to ensure your satisfaction.

### Paint Finish

Paint may develop hairline cracks in the finish, most notable around the joints. This is a result of natural expansion and contraction of the genuine hardwoods used in the manufacturing of this product. Hairline cracks are not considered a defect in the cabinetry or finish.

## CHARACTERISTICS OF SPECIALTY LAMINATES

**Specialty Laminates** feature design leading, high definition wood grain or high gloss laminates on doors, drawer fronts, overlay fillers, and Premium trim items. The surfaces are laminate based materials with an integrated top coat that provides superior beauty, durability, and performance while meeting or exceeding all of the KCMA performance standards. The core panel material is made of MDF to ensure a consistent and stable product.

Additional coordinating trim items in the cabinet box color are also available. Grain characteristics will vary across laminated parts to mimic natural wood grain patterns. A heat shield is required to separate all laminate products from heat producing units to be in compliance with cabinet warranty.

## CHARACTERISTICS OF PURESTYLE™

**PureStyle™** is the process of wrapping durable laminate materials around door frames and select trim and premium mouldings resulting in products with crisp styling features and a surface that provides abrasion resistance and meets/exceeds all of the KCMA performance standards. PureStyle™ products are wrapped (versus form pressed onto a Medium Density Fiberboard (MDF) slab like thermofoil) and has a clear, integrated top coat for superior durability. The lineals and core panel material are made of MDF to ensure a consistent and stable product.

These doors offer the durability of a laminate and the beauty of paint and finished wood while bringing peace of mind to those who care about creating a better environment — both inside and outside of their homes.

Textured wood grain PureStyle™ doors feature design leading, high definition wood grain laminates on doors, drawer fronts, overlay fillers, and Premium trim items. The surfaces are laminate based materials with an integrated top coat that provides superior beauty, durability, and performance while meeting or exceeding all of the KCMA performance standards. The core panel material is made of MDF to ensure a consistent and stable product. Additional coordinating trim items in the cabinet box color are also available.

A heat shield is required to separate all PureStyle™ products from heat producing units to be in compliance with cabinet warranty.

## SCHROCK CABINETRY'S 12-STEP FINISHING PROCESS

- 1. Wood Selection** – The selection of the finest woods including Alder, Cherry, Maple, Oak, Rustic Alder, and Rustic Hickory is the essential first step of Schrock's 12-step finishing process.
- 2. Sanded to Perfection** – Our sanding utilizes a fine grit paper, both with and against the wood grain. This process is completed on a vacuum table, allowing for a wood surface that is free of dust particles.
- 3. Achieving Natural Wood Tone** – Toner is applied to selected finishes, enhancing the naturalistic wood appearance.
- 4. Stain Application** – A hand-sprayed deep penetrating stain is evenly applied to all surfaces for even coverage on all profiles. On multi-step stains and glaze finishes, some non-facing surfaces (such as backs of doors, backs of panels, and matching veneer interiors) may not receive all steps noted. The resulting finish will be complementary and similar in color and have the same catalyzed top coat and cure, but may not result in the same color depth as facing surfaces.
- 5. Removal of Excess Stain** – The wood is hand-wiped to remove excess stain, emphasizing the cabinet's natural wood grain.
- 6. Catalyzed Sealer** – A tough, clear, catalyzed sealer is hand-sprayed on to protect the grain from moisture.
- 7. Drying Process** – For added durability, the sealed wood is oven cured to lock in the beauty of wood.
- 8. Hand-Sanded** – To achieve an ultra-smooth finish, we hand-sand the material one last time.
- 9. Dust Removal** – The resulting loose dust particles are removed from the surface of the wood.
- 10. Catalyzed Top Coat** – A premium quality catalyzed clear top coat is applied to protect the wood from environmental elements.
- 11. Final Top Coat Cure** – The top coat is cured to guarantee the strongest, most beautiful finish.
- 12. Final Inspection** – This last inspection is very thorough, ensuring quality and beauty. Our gift to you is that every cabinet is crafted with care.

## **Humidification**

<https://www.masterbrand.com/humidification>

## **Installation Instructions**

<https://www.masterbrand.com/installation>

## **Care and Cleaning**









<https://www.masterbrand.com/care-and-cleaning>

## NOTES

# Schrock™

## Door Style Reference Number Chart

Your Schrock price guide contains charts with prices for each cabinetry product, arranged according to a numerical code. Use the chart below to determine the price code for your preferred cabinetry style.

	Alder	Cherry	Maple	MDF	Oak	PureStyle™	Rustic Alder	Rustic Hickory	Specialty Laminates
Ainsley			13						
Asbury		18	17						
Aspen									16
Banbury		16	15						
Brantley		18	17						
Brinkman	8	11	8		6		8	8	
Campbell		18	16					16	
Carmin		11	8						
Chanley	10						10		
Denton		15	12	12					
Derazi									16
Edmond		13	10		9			10	
Elston	10	14	10	10	8		10	10	
Fletcher		8	5						
Galena	15	17	15						
Gallio									16
Galvyn 		6	2		1				
Harwell 		7	4		3				
Herra						16			
Huxley	15	17	15		12		15	15	
Ingalls 	6		6		5		6	6	
Jarret		15	12						
Kayes 		7	4						
Kennedy		16	12						
Lainey 		16	14						
Lormand 	3		3		2		3	3	
Morgan	4	7	4				4	4	
Natcher 		9	6						
Parker		13	10						
Patmore		8	5		4				
Pleasant Hill	9	12	9	9			9	9	
Prestley		16	14	14					
Rivali 		10	7						
Seaton		14	10						
Whittaker		13	10						
Willet 		11	8		7			8	

# FULL OVERLAY DOOR STYLES

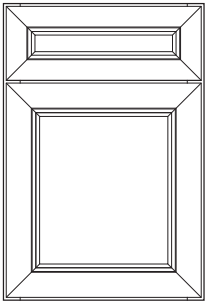

Ainsley Square  
(page 12)

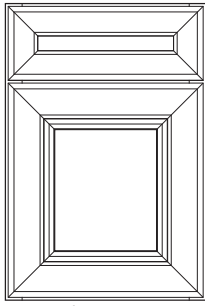

Asbury Square  
(page 12)

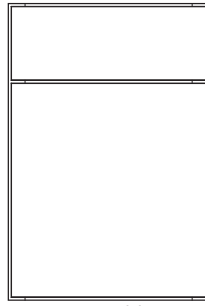

Aspen Slab  
(page 13)

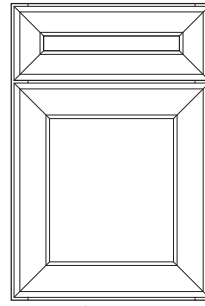

Banbury Square  
(page 13)

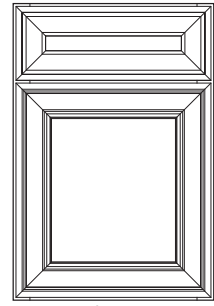

Brantley Square  
(page 14)

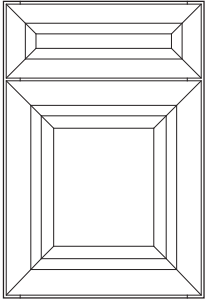

Campbell Square  
(page 15)

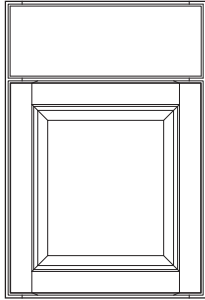

Carmin Square and Arch  
(page 15)

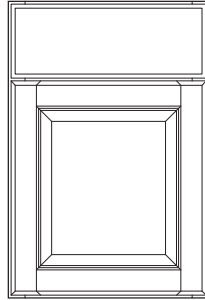

Chanley Square  
(page 16)

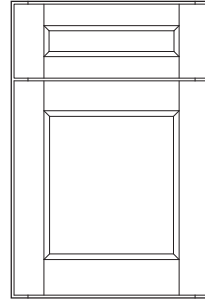

Denton Square  
(page 16)

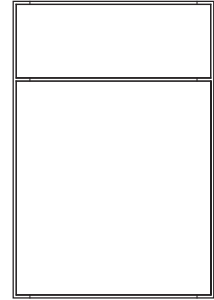

Derazi Slab  
(page 17)

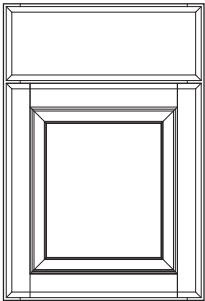

Edmond Square  
(page 17)

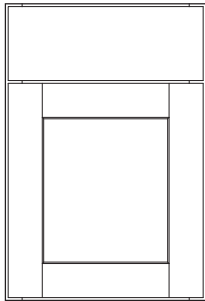

Elston Square  
(page 18)

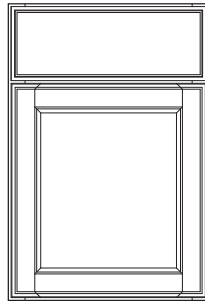

Fletcher Square  
(page 18)

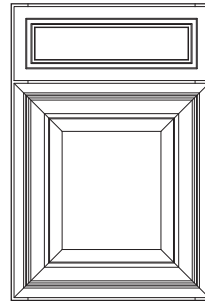

Galena Square  
(page 19)

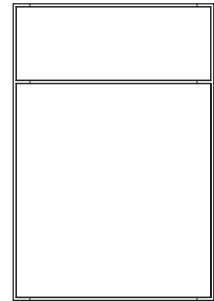

Gallio Slab  
(page 19)

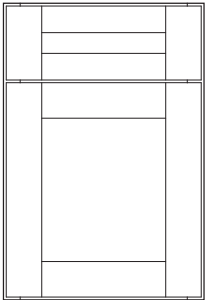

Herra Square  
(page 21)

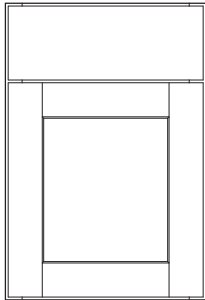

Huxley Square  
(page 21)

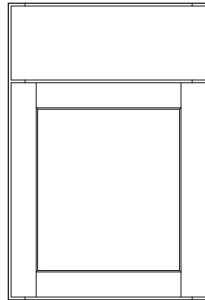

Ingalls Square **NEW**  
(page 22)

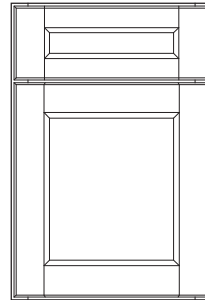

Jarret Square  
(page 22)

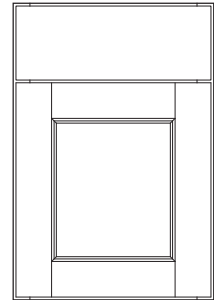

Kayes Square **NEW**  
(page 23)

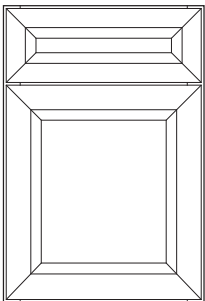

Kennedy Square  
(page 23)

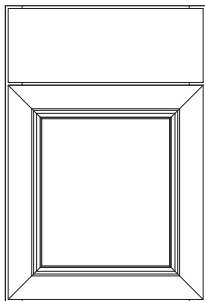

Lainey Square **NEW**  
(page 24)

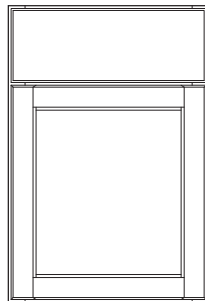

Morgan Square  
(page 25)

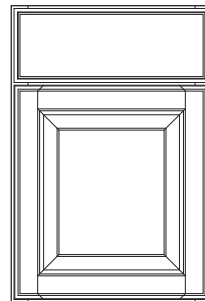

Parker Square and Arch  
(page 26)

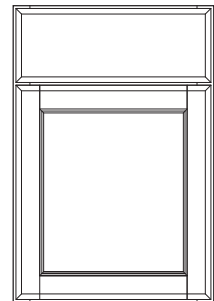

Patmore Square  
(page 26)

## FULL OVERLAY DOOR STYLES (cont'd)

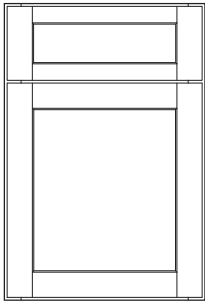

Pleasant Hill Square  
(page 27)

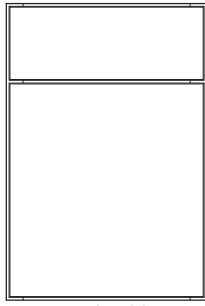

Prestley Slab  
(page 27)

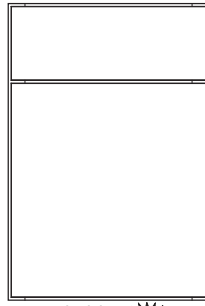

Rivali Slab **NEW**  
(page 28)

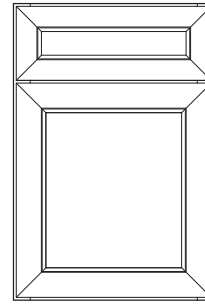

Seaton Square  
(page 28)

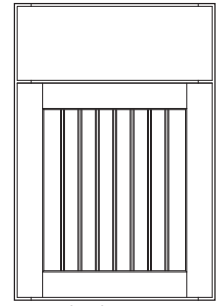

Whittaker Square  
(page 29)

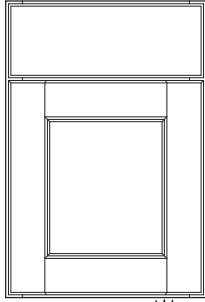

Willet Square **NEW**  
(page 29)

## PARTIAL OVERLAY DOOR STYLES

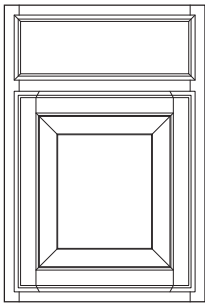

Brinkman Square and Arch  
(page 14)

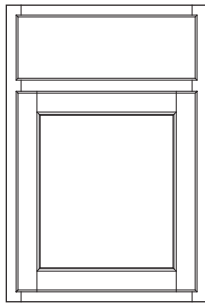

Galvyn Square **NEW**  
(page 20)

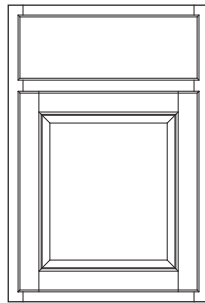

Harwell Square and Arch **NEW**  
(page 20)

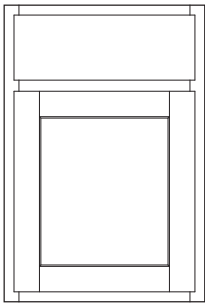

Lormand Square **NEW**  
(page 24)

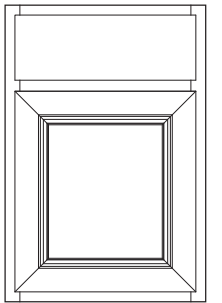

Natcher Square **NEW**  
(page 25)

# FULL AND PARTIAL OVERLAY SPECIFICATIONS

## Full Overlay

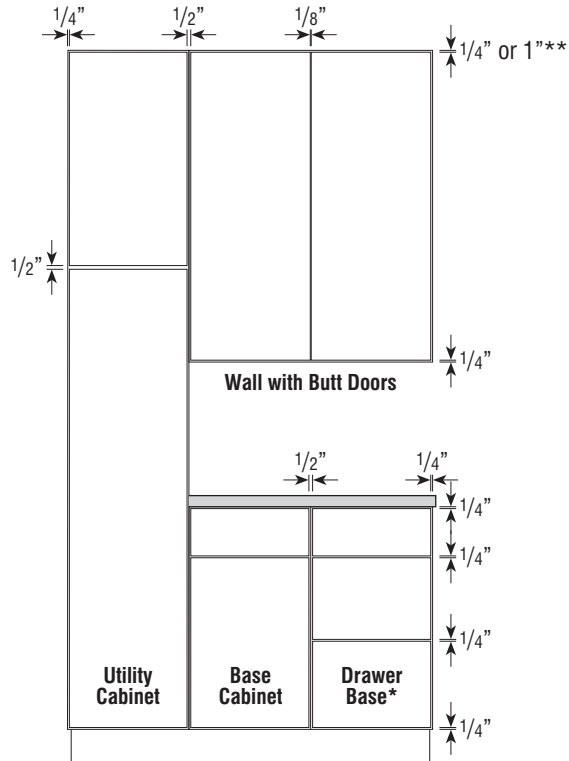

## Partial Overlay

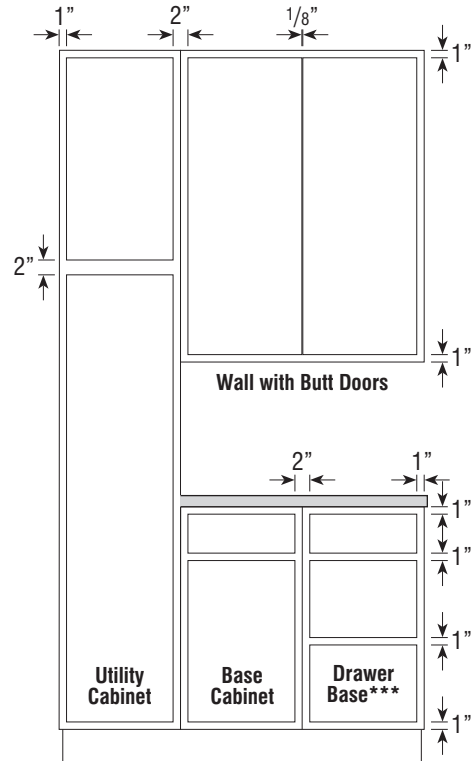

\*34 1/2" high application shown. On 32" high Full Overlay three drawer applications (drawer bases and sink bases with drawers), the reveal above the bottom drawer front is 1/2".

\*\*1" reveal when MFO is chosen

\*\*\*On Partial Overlay 2DB.. (Two Drawer Bases), reveal above the bottom drawer front is 2".

One double door center stile cabinet has the same reveal as two single door cabinets.



# DOOR STYLE SPECIFICATIONS

## Arch

- 9" wide wall cabinets will come in Arch if an Arch door style is selected.
- Base cabinets ordered in Arch will have Square doors.

## Cherry

- When Cherry door styles are ordered, it is recommended to apply a finished end option or a veneer end panel for exposed ends due to the natural aging of Cherry.

## Maple

- When a Paint or Paint with Glaze finish is specified, the door and/or drawer front center panel may be constructed of Medium Density Fiberboard (MDF), except when Whittaker door style or when Distressing or Heirlooming are specified. MDF provides a smoother finish when painted, and is more resistant to warping, expansion, and contraction. Doors, drawer fronts, and additional facings may consist of other hardwood components.

## MDF

- MDF door styles will use Maple for trim and panels, refer to Maple in the Species Availability charts.

## Rustic Alder & Rustic Hickory

- See trim section for availability of Rustic characteristics on trim items.

## All Door Styles

- All doors and drawer fronts are 3/4" thick unless otherwise noted.

## Door and Drawer Front Side Profiles

- Veneer and MDF components are shown with gray shading on side profiles. Solid-wood components do not have shading.
- On MDF door styles, all door and drawer front components will be in MDF.

## Wood Grain

- Pleasant Hill and Whittaker have a vertical grain direction on the drawer front center panel.
- Gallio drawer fronts have vertical grain.
- See reference images for wood grain direction on all other door styles.

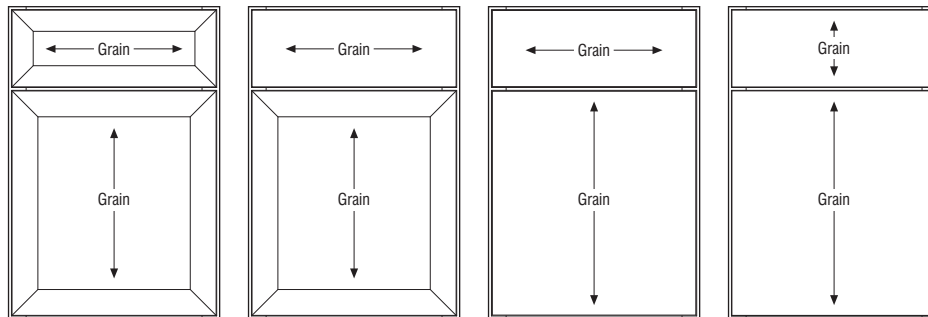

Prestley

Rivali

# DOOR STYLES

## Ainsley

	Alder	Cherry	Maple*	MDF	Oak	PureStyle™	Rustic Alder	Rustic Hickory	Specialty Laminates
Price Point	—	—	13	—	—	—	—	—	—

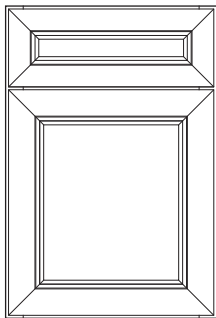

Square Base

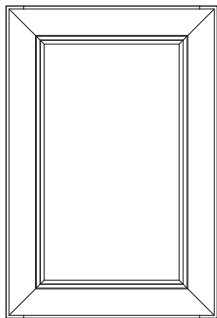

Square Wall



Optional Drawer Front: Slab (DFS LB)

### Door Options

ALF	CG	DPSRR	MD	SHMD	PRMD
•	•		•		

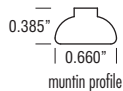

muntin profile

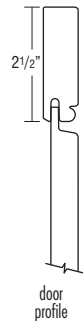

door profile

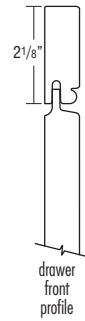

drawer front profile

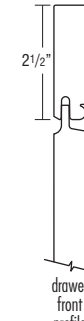

drawer front profile



optional drawer front profile

- Square Base and Square Wall Miter Doors
- Solid Raised Panel
- Full Overlay
- 5-piece Drawer Front Mitered to Match Door
- Drawer Front Options: DFS LB and DFS LBT
- Distressing Available

- See page 82 for 5-piece drawer front dimensions when specifying decorative hardware.

\*When a Paint or Paint with Glaze finish is specified, the door and/or drawer front center panel may be constructed of Medium Density Fiberboard (MDF), except when Distressing or Heirlooming are specified. MDF provides a smoother finish when painted, and is more resistant to warping, expansion, and contraction. Doors, drawer fronts, and additional facings may consist of other hardwood components.

## Asbury

	Alder	Cherry	Maple*	MDF	Oak	PureStyle™	Rustic Alder	Rustic Hickory	Specialty Laminates
Price Point	—	18	17	—	—	—	—	—	—

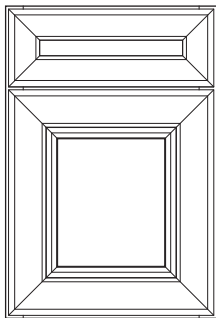

Square Base

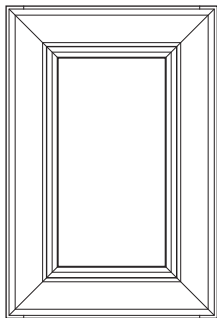

Square Wall

### Door Options

ALF	CG	DPSRR	MD	SHMD	PRMD
•	•		•		

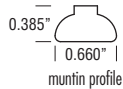

muntin profile



door profile

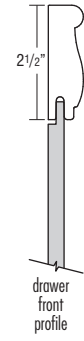

drawer front profile

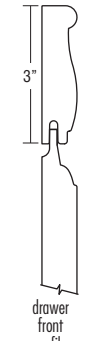

drawer front profile

- Square Base and Square Wall Miter Doors
- Solid Raised Panel on Door and Large Drawer Fronts
- Full Overlay
- 5-piece Drawer Front Mitered to Match Door
- Distressing Available

- See page 82 for 5-piece drawer front dimensions when specifying decorative hardware.

\*When a Paint or Paint with Glaze finish is specified, the door and/or drawer front center panel may be constructed of Medium Density Fiberboard (MDF), except when Distressing or Heirlooming are specified. MDF provides a smoother finish when painted, and is more resistant to warping, expansion, and contraction. Doors, drawer fronts, and additional facings may consist of other hardwood components.

# DOOR STYLES

<b>Aspen</b>	Alder	Cherry	Maple	MDF	Oak	PureStyle™	Rustic Alder	Rustic Hickory	Specialty Laminates
	Price Point	—	—	—	—	—	—	—	<b>16</b>

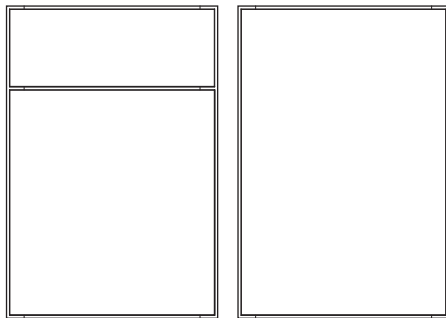

Slab Base

Slab Wall

**Door Options**

ALF	CG	DPSRR	MD	SHMD	PRMD
•					

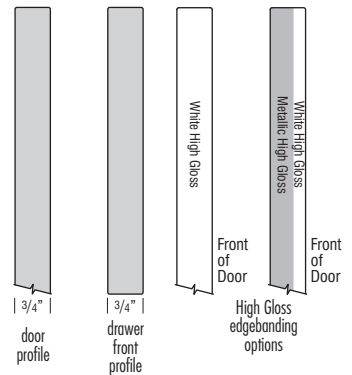

- Slab Doors and Drawer Fronts
- Full Overlay
- Two Edgebanding Options

- Doors, drawer fronts, overlay fillers, and selected premium trim items will be in White High Gloss (see Trim section for availability of premium trim items). Backs of doors, drawer fronts, and Premium panels will be white melamine.

**All other cabinet components and embellishments will be Painted White.**

- A heat shield is required to separate Aspen doors, drawer fronts, overlay fillers, and all laminate products from heat producing units to be in compliance with cabinet warranty.
- For complementing Contemporary Embellishments, see page 567.

<b>Banbury</b>	Alder	Cherry	Maple*	MDF	Oak	PureStyle™	Rustic Alder	Rustic Hickory	Specialty Laminates
	Price Point	—	<b>16</b>	<b>15</b>	—	—	—	—	—

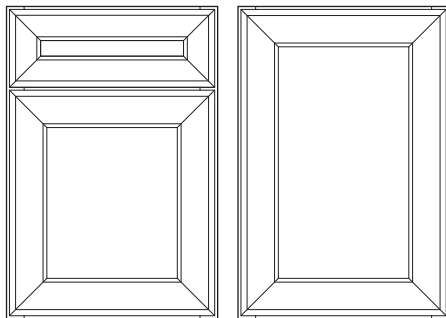

Square Base

Square Wall

**Door Options**

ALF	CG	DPSRR	MD	SHMD	PRMD
•	•		•		

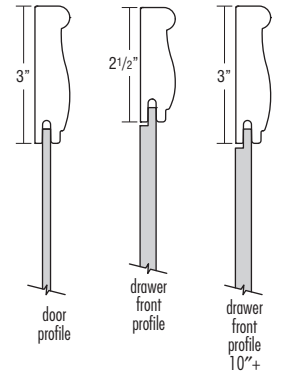
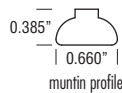

- Square Base and Square Wall Miter Doors
- Veneer Flat Panel
- Full Overlay
- 5-piece Drawer Front Mitered to Match Door

- See page 82 for 5-piece drawer front dimensions when specifying decorative hardware.

\*When a Paint or Paint with Glaze finish is specified, the door and/or drawer front center panel may be constructed of Medium Density Fiberboard (MDF), except when Heirlooming is specified. MDF provides a smoother finish when painted, and is more resistant to warping, expansion, and contraction. Doors, drawer fronts, and additional facings may consist of other hardwood components.

# DOOR STYLES

## Brantley

	Alder	Cherry	Maple*	MDF	Oak	PureStyle™	Rustic Alder	Rustic Hickory	Specialty Laminates
Price Point	—	18	17	—	—	—	—	—	—

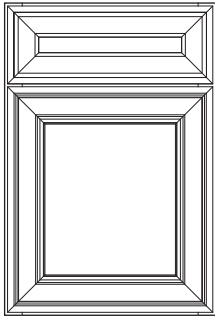

Square Base

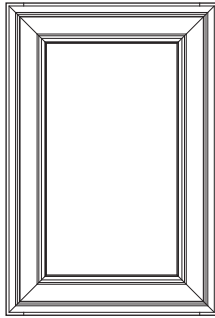

Square Wall

### Door Options

ALF	CG	DPSRR	MD	SHMD	PRMD
•	•		•		

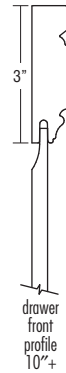
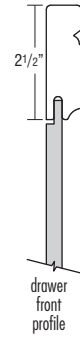
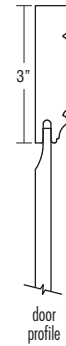
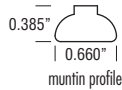

- Square Base and Square Wall Miter Doors
- Solid Reverse Raised Panel Door
- Full Overlay
- 5-piece Drawer Front Mitered to Match Door
- Faux Inset Design. Recommended for use with Faux Hinges (see page 578).

- 1/4" space filler or extended stile modification is necessary when applying faux hinge (strap or barrel) on varying depth cabinet or next to an appliance to allow for full door swing clearance.
- See page 82 for 5-piece drawer front dimensions when specifying decorative hardware.

\*When a Paint or Paint with Glaze finish is specified, the door and/or drawer front center panel may be constructed of Medium Density Fiberboard (MDF), except when Heirlooming is specified. MDF provides a smoother finish when painted, and is more resistant to warping, expansion, and contraction. Doors, drawer fronts, and additional facings may consist of other hardwood components.

## Brinkman

	Alder	Cherry	Maple*	MDF	Oak	PureStyle™	Rustic Alder	Rustic Hickory	Specialty Laminates
Price Point	8	11	8	—	6	—	8	8	—

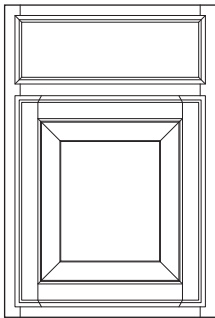

Square Base

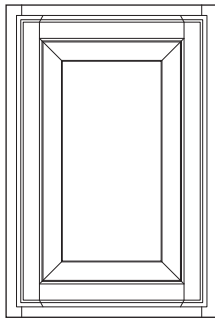

Square Wall

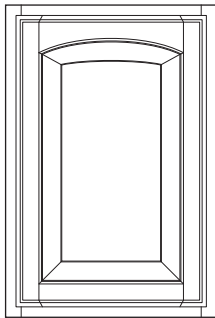

Arch Wall

### Door Options

ALF	CG	DPSRR	MD	SHMD	PRMD
•	•		•		

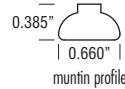

- Square Base and Square or Arch Wall Doors
- Solid Raised Panel
- Partial Overlay
- Profiled Slab Drawer Front
- Distressing Available

- Reverse Bevel Profile, Decorative Hardware Not Required

\*When a Paint or Paint with Glaze finish is specified, the door and/or drawer front center panel may be constructed of Medium Density Fiberboard (MDF), except when Distressing or Heirlooming are specified. MDF provides a smoother finish when painted, and is more resistant to warping, expansion, and contraction. Doors, drawer fronts, and additional facings may consist of other hardwood components.

# DOOR STYLES

<b>Campbell</b>	Alder	Cherry	Maple*	MDF	Oak	PureStyle™	Rustic Alder	<b>NEW</b> Rustic Hickory	Specialty Laminates
	<b>Price Point</b>	—	<b>18</b>	<b>16</b>	—	—	—	<b>16</b>	—

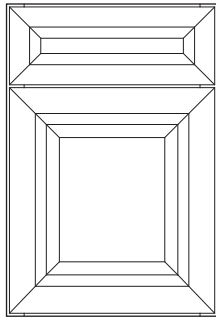

Square Base

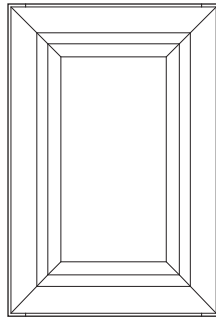

Square Wall

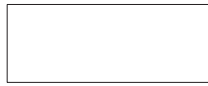

Optional Drawer Front:  
Slab (DFSFLB)

**Door Options**

ALF	CG	DPSRR	MD	SHMD	PRMD
•	•				

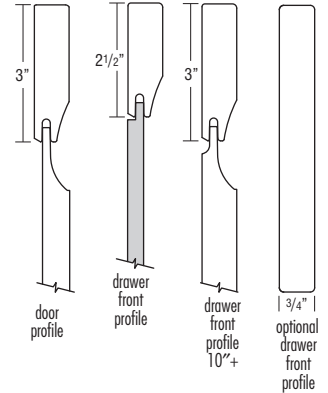

- Square Base and Square Wall Doors
- Solid Raised Panel Mitered Door
- Full Overlay
- 5-piece Drawer Front Mitered to Match Door
- Drawer Front Options: DFSFLB and DFSLBT
- Distressing Available

- See page 82 for 5-piece drawer front dimensions when specifying decorative hardware.

\*When a Paint or Paint with Glaze finish is specified, the door and/or drawer front center panel may be constructed of Medium Density Fiberboard (MDF), except when Distressing or Heirlooming are specified. MDF provides a smoother finish when painted, and is more resistant to warping, expansion, and contraction. Doors, drawer fronts, and additional facings may consist of other hardwood components.

<b>Carmin</b>	Alder	Cherry	Maple*	MDF	Oak	PureStyle™	Rustic Alder	Rustic Hickory	Specialty Laminates
	<b>Price Point</b>	—	<b>11</b>	<b>8</b>	—	—	—	—	—

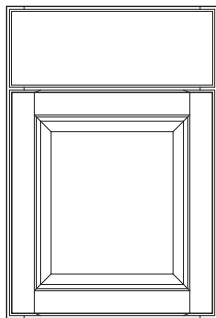

Square Base

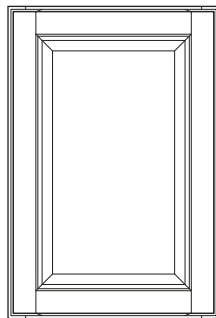

Square Wall

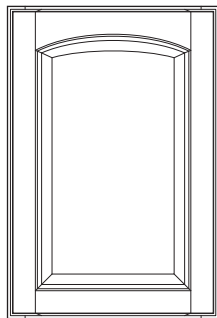

Arch Wall



Optional Drawer Front:  
Flat 5-piece (DFF5PC)

**Door Options**

ALF	CG	DPSRR	MD	SHMD	PRMD
•	•		•		

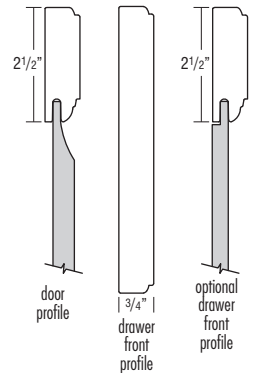
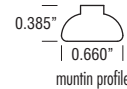

- Square Base and Square or Arch Wall Doors
- Veneer Raised Panel
- Full Overlay
- Profiled Slab Drawer Front
- Drawer Front Options: DFF5PC and DFF5PCSLBT

- See page 82 for 5-piece drawer front dimensions when specifying decorative hardware.

\*When a Paint or Paint with Glaze finish is specified, the door and/or drawer front center panel may be constructed of Medium Density Fiberboard (MDF). MDF provides a smoother finish when painted, and is more resistant to warping, expansion, and contraction. Doors, drawer fronts, and additional facings may consist of other hardwood components.

# DOOR STYLES

## Chanley

	Alder	Cherry	Maple	MDF	Oak	PureStyle™	Rustic Alder	Rustic Hickory	Specialty Laminates
Price Point	10	—	—	—	—	—	10	—	—

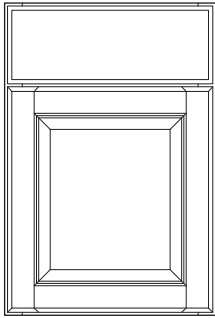

Square Base

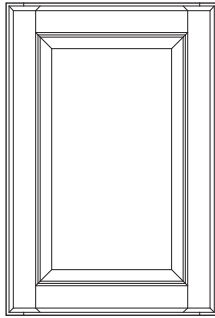

Square Wall

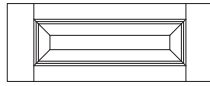

Optional Drawer Front:  
Raised 5-piece (DFR5PC)

### Door Options

ALF	CG	DPSRR	MD	SHMD	PRMD
•	•		•		

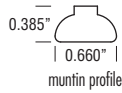

muntin profile



door profile



drawer front profile



optional drawer front profile (top and bottom)



optional drawer front profile (sides and 10"+)

- Square Base and Square Wall Doors
- Solid Raised Panel
- Full Overlay

- Profiled Slab Drawer Front
- Drawer Front Options: DFR5PC and DFR5PCSLBT
- Distressing Available
- See page 82 for 5-piece drawer front dimensions when specifying decorative hardware.

## Denton

	Alder	Cherry	Maple*	MDF	Oak	PureStyle™	Rustic Alder	Rustic Hickory	Specialty Laminates
Price Point	—	15	12	12	—	—	—	—	—

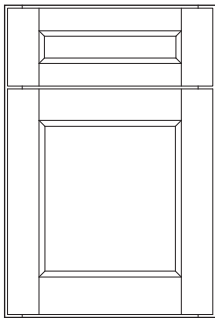

Square Base

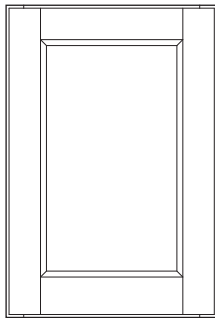

Square Wall



Optional Drawer Front:  
Slab (DFSLB)

### Door Options

ALF	CG	DPSRR	MD	SHMD	PRMD
•	•		•		

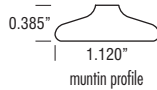

muntin profile

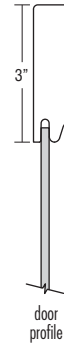

door profile

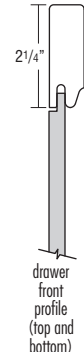

drawer front profile (top and bottom)

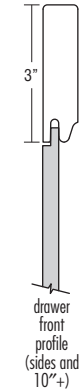

drawer front profile (sides and 10"+)

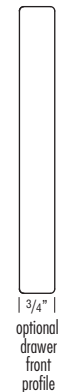

optional drawer front profile

- Square Base and Square Wall Doors
- Veneer\*\* Flat Panel
- Full Overlay
- 5-piece Drawer Front
- Drawer Front Options: DFSLB and DFSLBT

- See page 82 for 5-piece drawer front dimensions when specifying decorative hardware.
- \*When a Paint or Paint with Glaze finish is specified, the door and/or drawer front center panel may be constructed of Medium Density Fiberboard (MDF), except when Heirlooming is specified. MDF provides a smoother finish when painted, and is more resistant to warping, expansion, and contraction. Doors, drawer fronts, and additional facings may consist of other hardwood components.
- \*\*When ordered in MDF, all door and drawer front components will be in MDF.

# DOOR STYLES

## Derazi

	Alder	Cherry	Maple	MDF	Oak	PureStyle™	Rustic Alder	Rustic Hickory	Specialty Laminates
Price Point	—	—	—	—	—	—	—	—	16

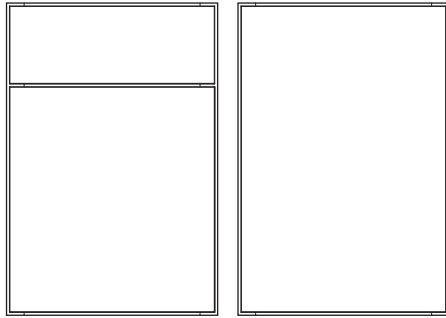

Slab Base

Slab Wall

**Door Options**

ALF	CG	DPSRR	MD	SHMD	PRMD
•					

**Finishes Cabinet Box Color Options**

	Black†	Cloud	Dover	Icy Avalanche	Storm	White
Arctic		•	•	•		•
Obsidian	•				•	

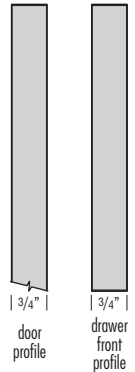

- Laminate Slab Door and Drawer Front with Matching Edgebanding
- Arctic and Obsidian feature a textured surface.
- Horizontal Grain Pattern for Contemporary Styling
- Full Overlay
- Doors, drawer fronts, overlay fillers, and selected premium trim items will be in the selected laminate. **All other cabinet components and trim items will be in the selected cabinet box color.**

- Doors and overlay fillers greater than 48" high will be two pieces. Doors will be doweled together with zinc connector pins and black plastic spacers. Replacement doors will be drilled and doweled but require field assembly.
  - A heat shield is required to separate Derazi doors, drawer fronts, overlay fillers, and all textured laminate products from heat producing units to be in compliance with cabinet warranty.
  - For complementing Contemporary Embellishments, see page 567.
  - Storm box color will have visible vertical grain matching end panels.
- †Trademark construction features non-matching laminate ends. Requires a veneer end upgrade (PE or APC) with FB, FPEB, Authentic End upgrade, or a field applied skin or door kit to achieve a matching cabinet end panel.

## Edmond

	Alder	Cherry	Maple*	MDF	Oak	PureStyle™	Rustic Alder	<b>NEW</b> Rustic Hickory	Specialty Laminates
Price Point	—	13	10	—	9	—	—	10	—

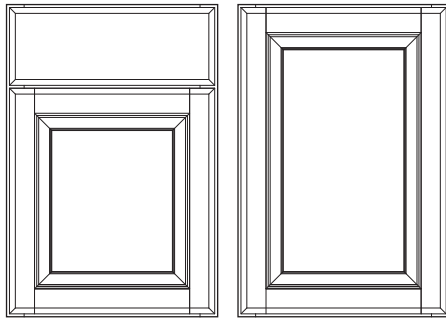

Square Base

Square Wall

**Door Options**

ALF	CG	DPSRR	MD	SHMD	PRMD
•	•		•		

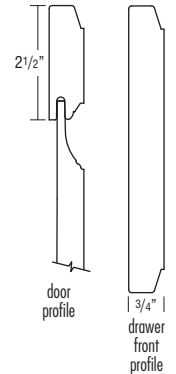
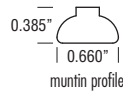

- Square Base and Square Wall Doors
- Solid Raised Panel
- Full Overlay
- Profiled Slab Drawer Front

- Distressing Available
- \*When a Paint or Paint with Glaze finish is specified, the door may be constructed of Medium Density Fiberboard (MDF), except when Distressing or Heirlooming are specified. MDF provides a smoother finish when painted, and is more resistant to warping, expansion, and contraction. Doors, drawer fronts, and additional facings may consist of other hardwood components.

# DOOR STYLES

## Elston

	Alder	Cherry	Maple*	MDF	Oak	PureStyle™	Rustic Alder	Rustic Hickory	Specialty Laminates
Price Point	10	14	10	10	8	—	10	10	—

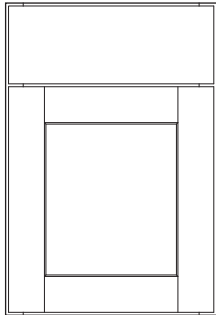

Square Base

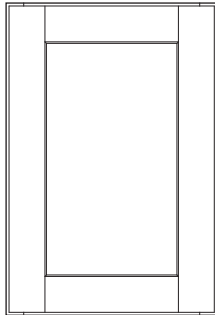

Square Wall

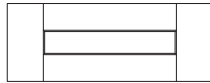

Optional Drawer Front:  
Flat 5-piece (DFF5PC)

### Door Options

ALF	CG	DPSRR	MD	SHMD	PRMD
•	•		•	•	•

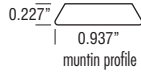

door profile



drawer front profile



optional drawer front profile (top and bottom)

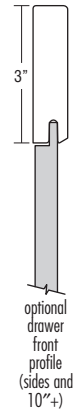

optional drawer front profile (sides and 10"+)

- Square Base and Square Wall Doors
- Veneer\*\* Flat Panel
- Full Overlay
- Slab Drawer Front
- Drawer Front Options: DFF5PC and DFF5PCSLBT

- See page 82 for 5-piece drawer front dimensions when specifying decorative hardware.

\*When a Paint or Paint with Glaze finish is specified, the door and/or drawer front center panel may be constructed of Medium Density Fiberboard (MDF), except when Heirlooming is specified. MDF provides a smoother finish when painted, and is more resistant to warping, expansion, and contraction. Doors, drawer fronts, and additional facings may consist of other hardwood components.

\*\*When ordered in MDF, all door and drawer front components will be in MDF.

## Fletcher

	Alder	Cherry	Maple*	MDF	Oak	PureStyle™	Rustic Alder	Rustic Hickory	Specialty Laminates
Price Point	—	8	5	—	—	—	—	—	—

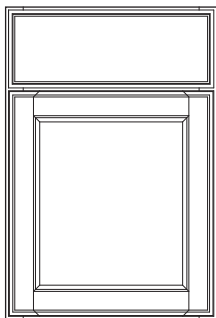

Square Base

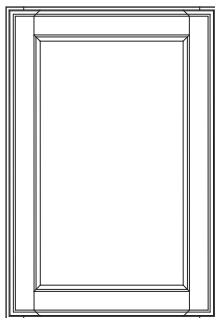

Square Wall

### Door Options

ALF	CG	DPSRR	MD	SHMD	PRMD
•	•		•		

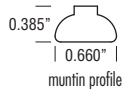

door profile



drawer front profile

- Square Base and Square Wall Doors
- Veneer Flat Panel
- Full Overlay
- Profiled Slab Drawer Front

\*When a Paint or Paint with Glaze finish is specified, the door and/or drawer front center panel may be constructed of Medium Density Fiberboard (MDF), except when Heirlooming is specified. MDF provides a smoother finish when painted, and is more resistant to warping, expansion, and contraction. Doors, drawer fronts, and additional facings may consist of other hardwood components.



# DOOR STYLES

Galena	Alder	Cherry	Maple*	MDF	Oak	PureStyle™	Rustic Alder	Rustic Hickory	Specialty Laminates
	Price Point	15	17	15	—	—	—	—	—

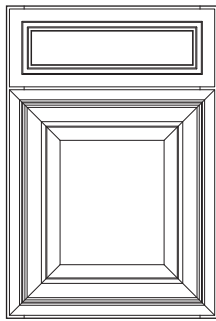

Square Base

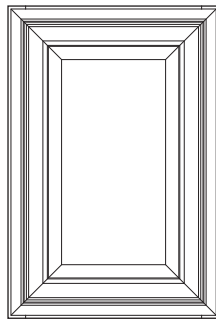

Square Wall

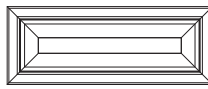

Optional Drawer Front:  
Flat 5-piece (DFF5PC)

**Door Options**

ALF	CG	DPSRR	MD	SHMD	PRMD
•			•		

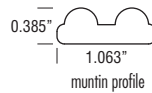

muntin profile



door profile



3/4" |  
drawer front profile



optional drawer front profile

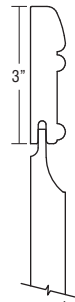

optional drawer front profile 10"+

- Square Base and Square Wall Miter Doors
- Solid Raised Panel on Door and Large 5-piece Drawer Fronts
- Full Overlay
- Solid Routed Drawer Front
- Drawer Front Options: DFF5PC and DFF5PCSLBT
- 5-piece 6 1/4" and 6 3/4" high drawer fronts have a flat center panel, 10" and taller drawer fronts have a raised center panel.

- Distressing Available
- See page 82 for 5-piece drawer front dimensions when specifying decorative hardware.

\*When a Paint or Paint with Glaze finish is specified, the door and/or drawer front center panel may be constructed of Medium Density Fiberboard (MDF), except when Distressing or Heirlooming are specified. MDF provides a smoother finish when painted, and is more resistant to warping, expansion, and contraction. Doors, drawer fronts, and additional facings may consist of other hardwood components.

Gallio	Alder	Cherry	Maple	MDF	Oak	PureStyle™	Rustic Alder	Rustic Hickory	Specialty Laminates
	Price Point	—	—	—	—	—	—	—	16

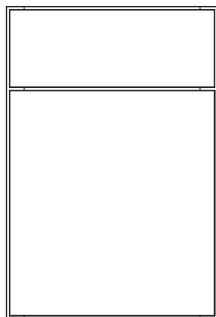

Slab Base

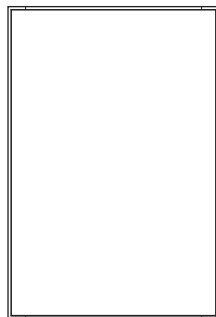

Slab Wall

**Door Options**

ALF	CG	DPSRR	MD	SHMD	PRMD
•					

**Finishes**

**Cabinet Box Color Options**

	Chocolate	Cloud	Dover	Icy Avalanche	Limestone	Morel	Seal	Thatch	White
Antler		•	•		•	•			•
Elk							•	•	
Gunstock	•							•	
Icy Avalanche Linea Nightfall				•					
Wharf			•		•				•



3/4" |  
door profile



3/4" |  
drawer front profile

- Slab Door and Drawer Front with Matching Edgebanding
- Elk, Gunstock, and Wharf feature a textured surface. Antler and Icy Avalanche Linea Nightfall are non-textured.
- Vertical Grain Pattern
- Full Overlay

- Doors, drawer fronts, overlay fillers, and selected premium trim items will be in the selected laminate. **All other cabinet components and trim items will be in the selected cabinet box color.**
- A heat shield is required to separate Gallio doors, drawer fronts, overlay fillers, and all laminate products from heat producing units to be in compliance with cabinet warranty.
- For complementing Contemporary Embellishments, see page 567.
- Wood Tone Stain box colors will have visible vertical grain matching end panels.

# DOOR STYLES

**Galvyn** NEW

	Alder	Cherry	Maple*	MDF	Oak	PureStyle™	Rustic Alder	Rustic Hickory	Specialty Laminates
Price Point	—	6	2	—	1	—	—	—	—

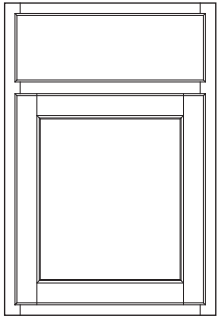

Square Base

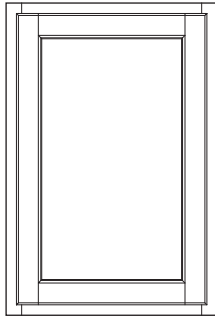

Square Wall

**Door Options**

ALF	CG	DPSRR	MD	SHMD	PRMD
•	•		•		

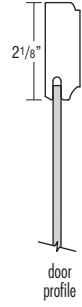
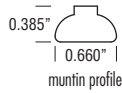

door profile



drawer front profile

- Square Base and Square Wall Doors
- Veneer Flat Panel
- Partial Overlay
- Profiled Slab Drawer Front

\*When a Paint or Paint with Glaze finish is specified, the door and/or drawer front center panel may be constructed of Medium Density Fiberboard (MDF), except when Heirlooming is specified. MDF provides a smoother finish when painted, and is more resistant to warping, expansion, and contraction. Doors, drawer fronts, and additional facings may consist of other hardwood components.

**Harwell** NEW

	Alder	Cherry	Maple*	MDF	Oak	PureStyle™	Rustic Alder	Rustic Hickory	Specialty Laminates
Price Point	—	7	4	—	3	—	—	—	—

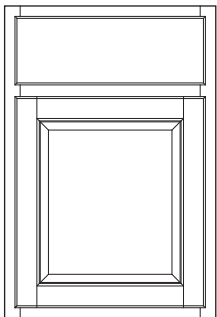

Square Base

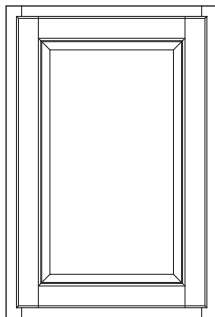

Square Wall

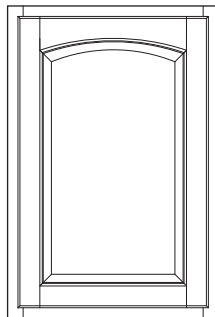

Arch Wall

**Door Options**

ALF	CG	DPSRR	MD	SHMD	PRMD
•	•		•		

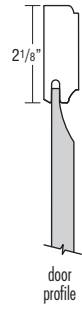
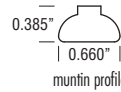

door profile



drawer front profile

- Square Base and Square or Arch Wall Doors
- Veneer Raised Panel
- Partial Overlay
- Profiled Slab Drawer Front

\*When a Paint or Paint with Glaze finish is specified, the door and/or drawer front center panel may be constructed of Medium Density Fiberboard (MDF). MDF provides a smoother finish when painted, and is more resistant to warping, expansion, and contraction. Doors, drawer fronts, and additional facings may consist of other hardwood components.

# DOOR STYLES

Herra	Alder	Cherry	Maple	MDF	Oak	PureStyle™	Rustic Alder	Rustic Hickory	Specialty Laminates
	Price Point	—	—	—	—	—	16	—	—

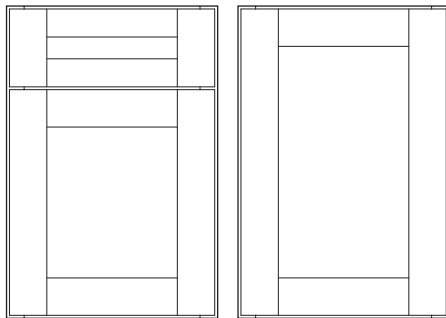

Square Base

Square Wall

**Door Options**

ALF	CG	DPSRR	MD	SHMD	PRMD
•					

**Finishes**

	Cabinet Box Color Options			
	Chocolate	Icy Avalanche	Seal	Thatch
Elk			•	•
Gunstock	•			•
Icy Avalanche Linea Nighfall		•		

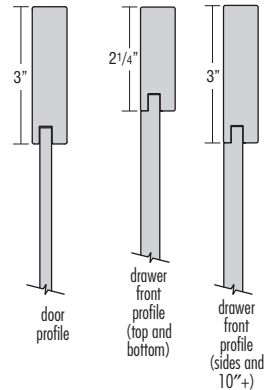

- Square Base and Square Wall Doors
- Textured Wood Grain Laminate Wrapped MDF Door and Drawer Rails
- Full Overlay
- 5-piece Drawer Front

- Doors, drawer fronts, overlay fillers, and selected premium trim items will be Elk. All other cabinet components and embellishments will be in selected cabinet box color and species.
- A heat shield is required to separate Herra doors, drawer fronts, overlay fillers, and all laminate products from heat producing units to be in compliance with cabinet warranty.
- See page 82 for 5-piece drawer front dimensions when specifying decorative hardware.
- Wood Tone Stain box colors will have visible vertical grain matching end panels.

Huxley	Alder	Cherry	Maple*	MDF	Oak	PureStyle™	Rustic Alder	Rustic Hickory	Specialty Laminates
	Price Point	15	17	15	—	—	15	15	—

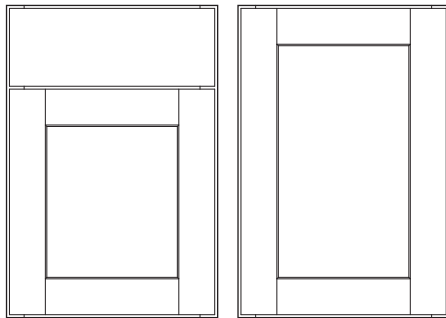

Square Base

Square Wall

Optional Drawer Front:  
Flat 5-piece (DFF5PC)

**Door Options**

ALF	CG	DPSRR	MD	SHMD	PRMD
•	•		•	•	•

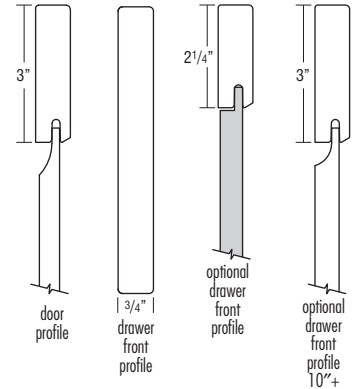
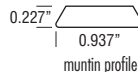

- Square Base and Square Wall Doors
- Solid Reverse Raised Panel Door
- Full Overlay
- Slab Drawer Front
- Drawer Front Options: DFF5PC and DFF5PCSLBT

- See page 82 for 5-piece drawer front dimensions when specifying decorative hardware.
- \*When a Paint or Paint with Glaze finish is specified, the door and/or drawer front center panel may be constructed of Medium Density Fiberboard (MDF), except when Heirlooming is specified. MDF provides a smoother finish when painted, and is more resistant to warping, expansion, and contraction. Doors, drawer fronts, and additional facings may consist of other hardwood components.

# DOOR STYLES

**Ingalis** 

	Alder	Cherry	Maple*	MDF	Oak	PureStyle™	Rustic Alder	Rustic Hickory	Specialty Laminates
Price Point	6	—	6	—	5	—	6	6	—

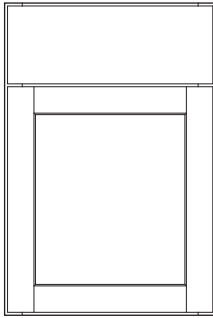

Square Base

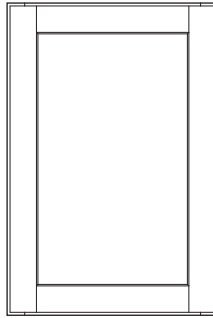

Square Wall

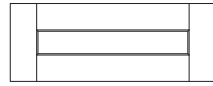

Optional Drawer Front:  
Flat 5-piece (DFF5PC)

**Door Options**

ALF	CG	DPSRR	MD	SHMD	PRMD
•	•		•		

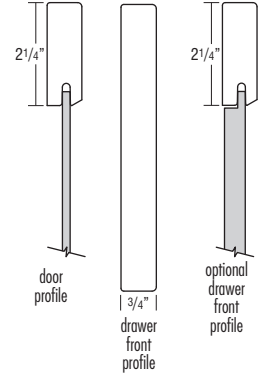
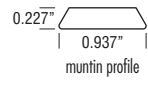

- Square Base and Square Shaker Style Doors
- Recessed Panel
- Full Overlay
- Slab Drawer Front
- Drawer Front Options: DFF5PC and DFF5PCSLBT

- See page 82 for 5-piece drawer front dimensions when specifying decorative hardware.
- \*When a Paint or Paint with Glaze finish is specified, the door and/or drawer front center panel may be constructed of Medium Density Fiberboard (MDF), except when Heirlooming is specified. MDF provides a smoother finish when painted, and is more resistant to warping, expansion, and contraction. Doors, drawer fronts, and additional facings may consist of other hardwood components.

**Jarret**

	Alder	Cherry	Maple*	MDF	Oak	PureStyle™	Rustic Alder	Rustic Hickory	Specialty Laminates
Price Point	—	15	12	—	—	—	—	—	—

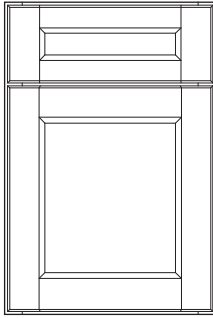

Square Base

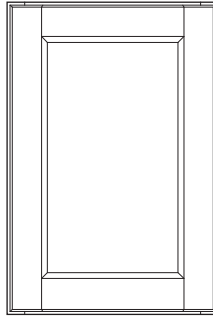

Square Wall



Optional Drawer Front:  
Slab (DFS LB)

**Door Options**

ALF	CG	DPSRR	MD	SHMD	PRMD
•	•		•		

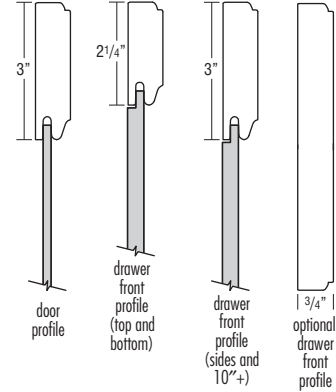
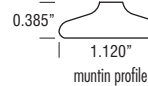

- Square Base and Square Wall Doors
- Veneer Flat Panel
- Full Overlay
- 5-piece Drawer Front
- Drawer Front Options: DFS LB and DFS LB T

- See page 82 for 5-piece drawer front dimensions when specifying decorative hardware.
- \*When a Paint or Paint with Glaze finish is specified, the door and/or drawer front center panel may be constructed of Medium Density Fiberboard (MDF), except when Heirlooming is specified. MDF provides a smoother finish when painted, and is more resistant to warping, expansion, and contraction. Doors, drawer fronts, and additional facings may consist of other hardwood components.

# DOOR STYLES

**Kayes** 

	Alder	Cherry	Maple*	MDF	Oak	PureStyle™	Rustic Alder	Rustic Hickory	Specialty Laminates
Price Point	—	7	4	—	—	—	—	—	—

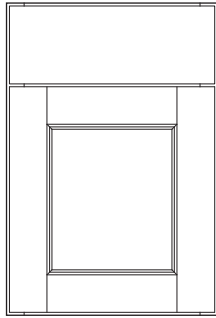

Square Base

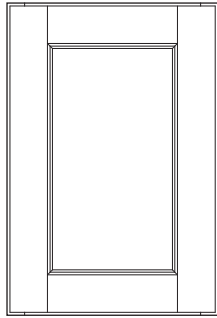

Square Wall

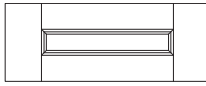

Optional Drawer Front:  
Flat 5-piece (DFF5PC)

**Door Options**

ALF	CG	DPSRR	MD	SHMD	PRMD
•			•		

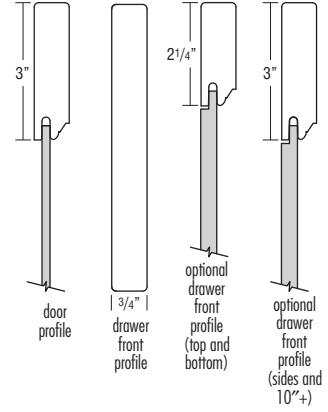
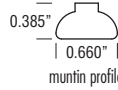

- Square Base and Square Wall Doors
- Veneer Flat Panel
- Full Overlay
- Slab Drawer Front
- Drawer Front Options: DFF5PC and DFF5PCSLBT

- See page 82 for 5-piece drawer front dimensions when specifying decorative hardware.
- \*When a Paint or Paint with Glaze finish is specified, the door and/or drawer front center panel may be constructed of Medium Density Fiberboard (MDF), except when Heirlooming is specified. MDF provides a smoother finish when painted, and is more resistant to warping, expansion, and contraction. Doors, drawer fronts, and additional facings may consist of other hardwood components.

**Kennedy**

	Alder	Cherry	Maple*	MDF	Oak	PureStyle™	Rustic Alder	Rustic Hickory	Specialty Laminates
Price Point	—	16	12	—	—	—	—	—	—

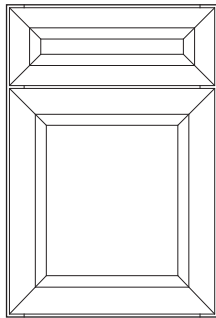

Square Base

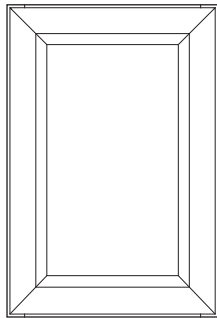

Square Wall



Optional Drawer Front:  
Slab (DFSLB)

**Door Options**

ALF	CG	DPSRR	MD	SHMD	PRMD
•					

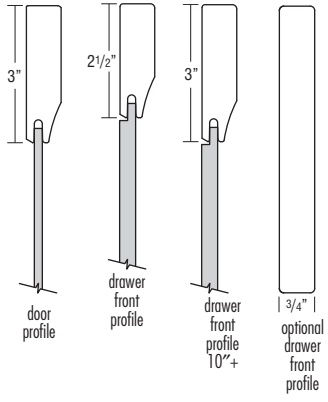

- Square Base and Square Wall Doors
- Veneer Flat Panel Mitered Door
- Full Overlay
- 5-piece Drawer Front Mitered to Match Door
- Drawer Front Options: DFSLB and DFSLBT

- See page 82 for 5-piece drawer front dimensions when specifying decorative hardware.
- \*When a Paint or Paint with Glaze finish is specified, the door and/or drawer front center panel may be constructed of Medium Density Fiberboard (MDF), except when Heirlooming is specified. MDF provides a smoother finish when painted, and is more resistant to warping, expansion, and contraction. Doors, drawer fronts, and additional facings may consist of other hardwood components.

# DOOR STYLES

Lainey 

	Alder	Cherry	Maple*	MDF	Oak	PureStyle™	Rustic Alder	Rustic Hickory	Specialty Laminates
Price Point	—	16	14	—	—	—	—	—	—

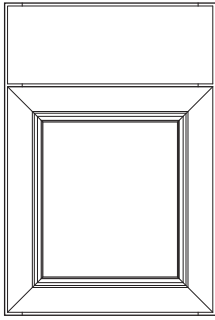

Square Base

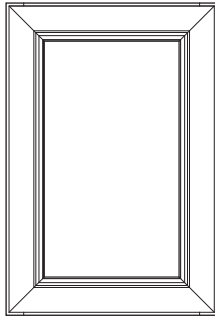

Square Wall

**Door Options**

ALF	CG	DPSRR	MD	SHMD	PRMD
•	•		•		

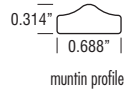

muntin profile

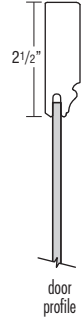

door profile



drawer front profile

- Square Base and Square Wall Doors
- Veneer Flat Panel Mitered Door
- Full Overlay
- Slab Drawer Front

\*When a Paint or Paint with Glaze finish is specified, the door and/or drawer front center panel may be constructed of Medium Density Fiberboard (MDF), except when Heirlooming is specified. MDF provides a smoother finish when painted, and is more resistant to warping, expansion, and contraction. Doors, drawer fronts, and additional facings may consist of other hardwood components.

Lormand 

	Alder	Cherry	Maple*	MDF	Oak	PureStyle™	Rustic Alder	Rustic Hickory	Specialty Laminates
Price Point	3	—	3	—	2	—	3	3	—

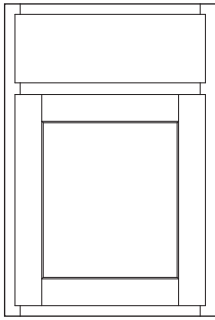

Square Base

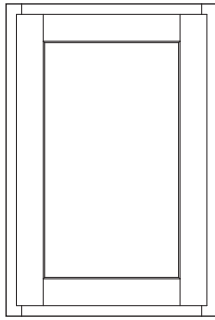

Square Wall

**Door Options**

ALF	CG	DPSRR	MD	SHMD	PRMD
•	•		•		

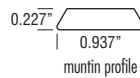

muntin profile

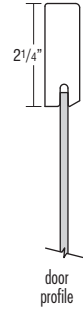

door profile



drawer front profile

- Square Base and Square Wall Shaker Style Doors
- Recessed Panel
- Partial Overlay
- Slab Drawer Front

\*When a Paint or Paint with Glaze finish is specified, the door and/or drawer front center panel may be constructed of Medium Density Fiberboard (MDF), except when Heirlooming is specified. MDF provides a smoother finish when painted, and is more resistant to warping, expansion, and contraction. Doors, drawer fronts, and additional facings may consist of other hardwood components.

# DOOR STYLES

Morgan	Alder	Cherry	Maple*	MDF	Oak	PureStyle™	Rustic Alder	Rustic Hickory	Specialty Laminates
	Price Point	4	7	4	—	—	—	4	4

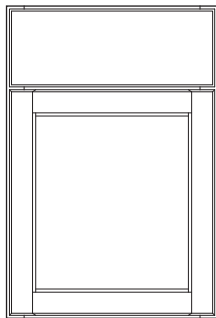

Square Base

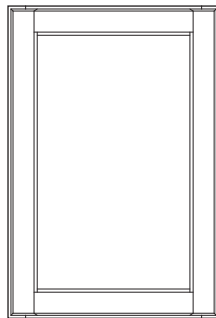

Square Wall

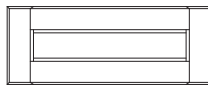

Optional Drawer Front:  
Flat 5-piece (DFF5PC)

**Door Options**

ALF	CG	DPSRR	MD	SHMD	PRMD
•	•		•	•	•

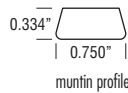

muntin profile

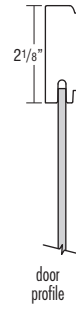

door profile

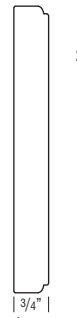

optional drawer front profile

3/4\"/>

- Square Base and Square Wall Doors
- Veneer Flat Panel
- Full Overlay
- Profiled Slab Drawer Front
- Drawer Front Options: DFF5PC and DFF5PCSLBT

- See page 82 for 5-piece drawer front dimensions when specifying decorative hardware.
- \*When a Paint or Paint with Glaze finish is specified, the door and/or drawer front center panel may be constructed of Medium Density Fiberboard (MDF), except when Heirlooming is specified. MDF provides a smoother finish when painted, and is more resistant to warping, expansion, and contraction. Doors, drawer fronts, and additional facings may consist of other hardwood components.

Natcher 	Alder	Cherry	Maple*	MDF	Oak	PureStyle™	Rustic Alder	Rustic Hickory	Specialty Laminates
	Price Point	—	9	6	—	—	—	—	—

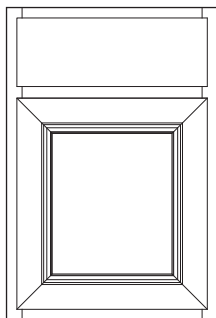

Square Base

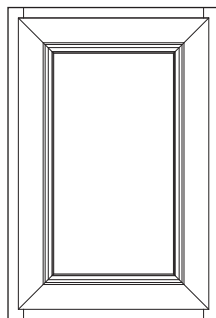

Square Wall

**Door Options**

ALF	CG	DPSRR	MD	SHMD	PRMD
•	•		•		

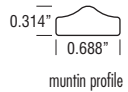

muntin profile

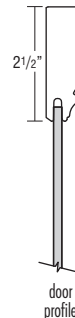

door profile



3/4\"/>

- Square Base and Square Wall Doors
- Veneer Flat Panel Mitered Door
- Partial Overlay
- Slab Drawer Front

- \*When a Paint or Paint with Glaze finish is specified, the door and/or drawer front center panel may be constructed of Medium Density Fiberboard (MDF), except when Heirlooming is specified. MDF provides a smoother finish when painted, and is more resistant to warping, expansion, and contraction. Doors, drawer fronts, and additional facings may consist of other hardwood components.

# DOOR STYLES

## Parker

	Alder	Cherry	Maple*	MDF	Oak	PureStyle™	Rustic Alder	Rustic Hickory	Specialty Laminates
Price Point	—	13	10	—	—	—	—	—	—

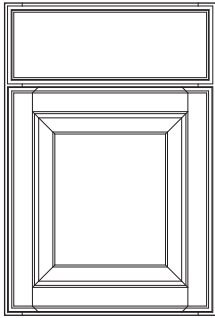

Square Base

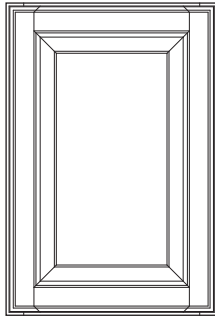

Square Wall

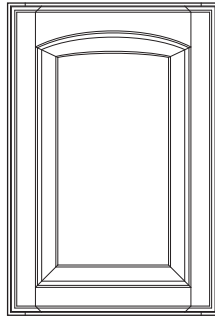

Arch Wall



Optional Drawer Front:  
Raised 5-piece (DFR5PC)

**Door Options**

ALF	CG	DPSRR	MD	SHMD	PRMD
•	•		•		

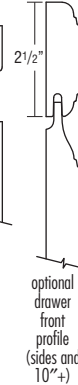
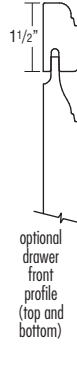
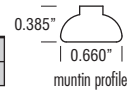

- Square Base and Square or Arch Wall Doors
- Solid Raised Panel
- Full Overlay
- Slab Drawer Front
- Drawer Front Options: DFR5PC and DFR5PCSLBT
- Distressing Available

- See page 82 for 5-piece drawer front dimensions when specifying decorative hardware.

\*When a Paint or Paint with Glaze finish is specified, the door and/or drawer front center panel may be constructed of Medium Density Fiberboard (MDF), except when Distressing or Heirlooming are specified. MDF provides a smoother finish when painted, and is more resistant to warping, expansion, and contraction. Doors, drawer fronts, and additional facings may consist of other hardwood components.

## Patmore

	Alder	Cherry	Maple*	MDF	Oak	PureStyle™	Rustic Alder	Rustic Hickory	Specialty Laminates
Price Point	—	8	5	—	4	—	—	—	—

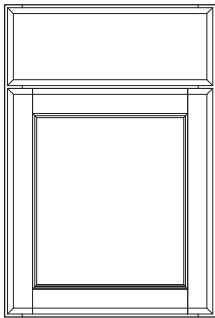

Square Base

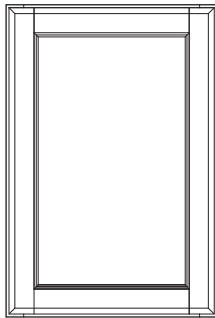

Square Wall

**Door Options**

ALF	CG	DPSRR	MD	SHMD	PRMD
•	•		•		

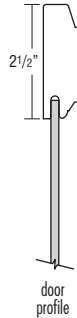
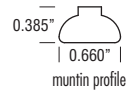

- Square Base and Square Wall Doors
- Veneer Flat Panel
- Full Overlay
- Profiled Slab Drawer Front

\*When a Paint or Paint with Glaze finish is specified, the door and/or drawer front center panel may be constructed of Medium Density Fiberboard (MDF), except when Heirlooming is specified. MDF provides a smoother finish when painted, and is more resistant to warping, expansion, and contraction. Doors, drawer fronts, and additional facings may consist of other hardwood components.



# DOOR STYLES

Pleasant Hill	Alder	Cherry	Maple*	MDF	Oak	PureStyle™	Rustic Alder	Rustic Hickory	Specialty Laminates
	Price Point	9	12	9	9	—	—	9	9

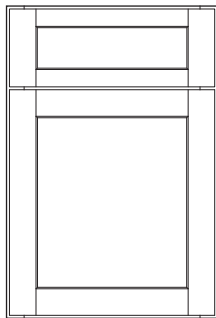

Square Base

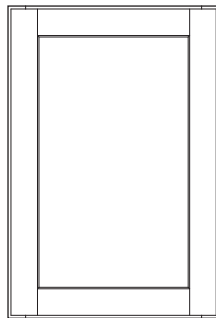

Square Wall



Optional Drawer Front:  
Slab (DFSFLB)

**Door Options**

ALF	CG	DPSRR	MD	SHMD	PRMD
•	•	•	•	•	•

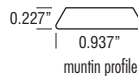

muntin profile

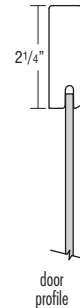

door profile

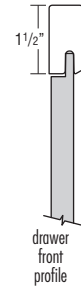

drawer front profile



optional drawer front profile

- Square Base and Square Wall Shaker Style Doors
- Veneer\*\* Flat Panel (Solid reverse raised door center panel is available as a modification, see DPSRR on page 44.)
- Full Overlay
- 5-piece Drawer Front
- Drawer Front Options: DFSFLB and DFSLBT

- See page 82 for 5-piece drawer front dimensions when specifying decorative hardware.

\*When a Paint or Paint with Glaze finish is specified, the door and/or drawer front center panel may be constructed of Medium Density Fiberboard (MDF), except when Heirlooming is specified. MDF provides a smoother finish when painted, and is more resistant to warping, expansion, and contraction. Doors, drawer fronts, and additional facings may consist of other hardwood components.

\*\*When ordered in MDF, all door and drawer front components will be in MDF. DPSRR not available on Pleasant Hill MDF.

Prestley	Alder	Cherry	Maple	MDF	Oak	PureStyle™	Rustic Alder	Rustic Hickory	Specialty Laminates
	Price Point	—	16	14	14	—	—	—	—

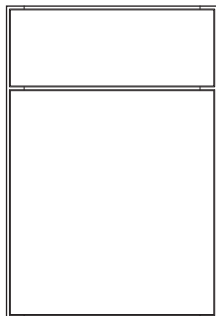

Slab Base

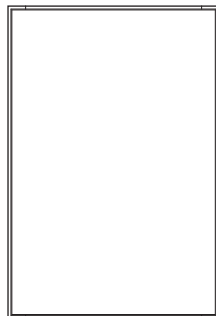

Slab Wall

**Door Options**

ALF	CG	DPSRR	MD	SHMD	PRMD
•					

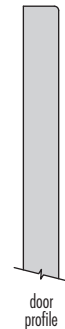

door profile



drawer front profile

- Slab Doors and Drawer Fronts
- Veneer Face and Back
- Wood Edging on All Edges
- Furniture Board Core

- Full Overlay
- Grain direction is vertical on doors and horizontal on drawer fronts.
- When ordered in MDF, all door and drawer front components will be in MDF.

# DOOR STYLES

**Rivali** NEW

	Alder	Cherry	Maple	MDF	Oak	PureStyle™	Rustic Alder	Rustic Hickory	Specialty Laminates
Price Point	—	10	7	—	—	—	—	—	—

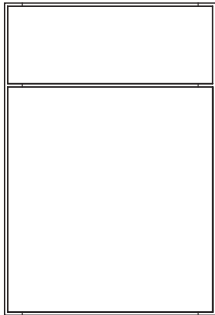

Slab Base

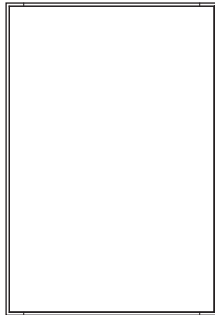

Slab Wall

**Door Options**

ALF	CG	DPSRR	MD	SHMD	PRMD
•					



3/4" |  
door profile



3/4" |  
drawer front profile

- Slab Doors and Drawer Fronts
- Veneer Face and Back
- Veneer Edging on all Edges

- Furniture Board Core
- Full Overlay

**Seaton**

	Alder	Cherry	Maple*	MDF	Oak	PureStyle™	Rustic Alder	Rustic Hickory	Specialty Laminates
Price Point	—	14	10	—	—	—	—	—	—

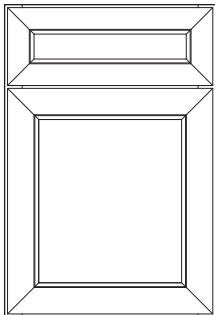

Square Base

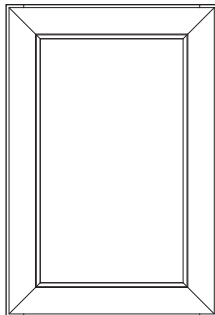

Square Wall



Optional Drawer Front:  
Slab (DFSLB)

**Door Options**

ALF	CG	DPSRR	MD	SHMD	PRMD
•	•		•		

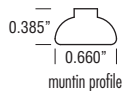

0.385" | 0.660" |  
muntin profile



2 1/2" |  
door profile

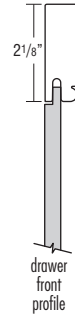

2 1/8" |  
drawer front profile



2 1/2" |  
drawer front profile 10"+



3/4" |  
optional drawer front profile

- Square Base and Square Wall Miter Doors
- Veneer Flat Panel
- Full Overlay
- 5-piece Drawer Front Mitered to Match Door
- Drawer Front Options: DFSLB and DFSLBT

- See page 82 for 5-piece drawer front dimensions when specifying decorative hardware.

\*When a Paint or Paint with Glaze finish is specified, the door and/or drawer front center panel may be constructed of Medium Density Fiberboard (MDF), except when Heirlooming is specified. MDF provides a smoother finish when painted, and is more resistant to warping, expansion, and contraction. Doors, drawer fronts, and additional facings may consist of other hardwood components.

# DOOR STYLES

Whittaker	Alder	Cherry	Maple	MDF	Oak	PureStyle™	Rustic Alder	Rustic Hickory	Specialty Laminates
	Price Point	—	13	10	—	—	—	—	—

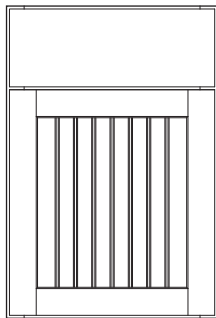

Square Base

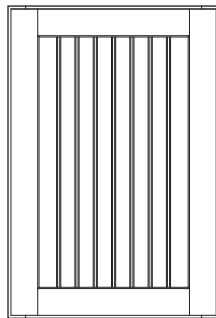

Square Wall

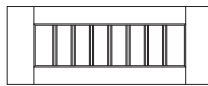

Optional Drawer Front:  
Flat 5-piece (DFF5PC)

**Door Options**

ALF	CG	DPSRR	MD	SHMD	PRMD
•			•	•	•

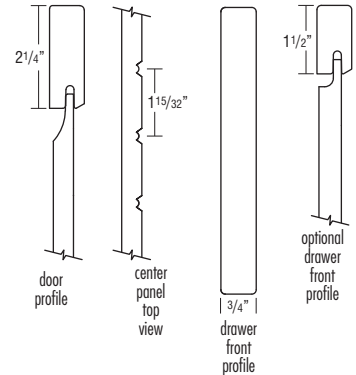
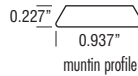

- Square Base and Square Wall Shaker Style Doors
- Solid Reverse Raised Beaded Panel
- Full Overlay
- Slab Drawer Front
- Drawer Front Options: DFF5PC and DFF5PCSLBT

- When DFF5PC is selected on a 2DB48, drawer front will have a vertical cross rail with two center panels.
- Will not use MDF center panel on Paint or Paint with Glaze finishes. See page 11 for more details.
- Beaded center panel on 5-piece drawer fronts will not align with doors when used on cabinets with double doors and a full width drawer.
- See page 82 for 5-piece drawer front dimensions when specifying decorative hardware.

Willet <small>NEW</small>	Alder	Cherry	Maple*	MDF	Oak	PureStyle™	Rustic Alder	Rustic Hickory	Specialty Laminates
	Price Point	—	11	8	—	7	—	—	8

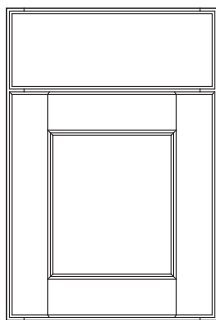

Square Base

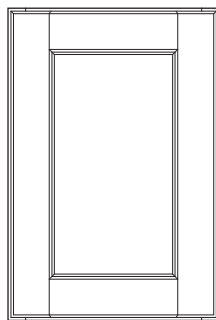

Square Wall



Optional Drawer Front:  
Flat 5-piece (DFF5PC)

**Door Options**

ALF	CG	DPSRR	MD	SHMD	PRMD
•			•		

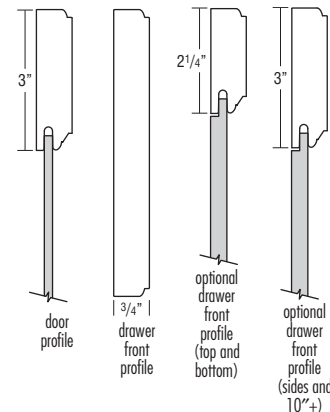
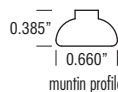

- Square Base and Square Wall Doors
- Veneer Flat Panel
- Full Overlay
- Profiled Slab Drawer Front
- Drawer Front Options: DFF5PC and DFF5PCSLBT

- See page 82 for 5-piece drawer front dimensions when specifying decorative hardware.
- \*When a Paint or Paint with Glaze finish is specified, the door and/or drawer front center panel may be constructed of Medium Density Fiberboard (MDF), except when Heirlooming is specified. MDF provides a smoother finish when painted, and is more resistant to warping, expansion, and contraction. Doors, drawer fronts, and additional facings may consist of other hardwood components.

## PREMIUM COLOR PALETTE

	OPTION NAME	DESCRIPTION/LIMITATIONS	MATCHING LAMINATE ENDS <sup>▲</sup>	UPCHARGE**	DISTRESSING AVAILABILITY	HEIRLOOMING AVAILABILITY	MATTE SHEEN AVAILABILITY
Stains	<b>Grizzly</b>	A deep brown finish with gray undertones and beautiful depth.	✓	12%	✓	N/A	✓
	<b>Kodiak</b>	A dark brown finish with gray and yellow undertones and a deep, rich hue.	✓	12%	✓	N/A	✓
	<b>Storm</b>	A semi translucent stone gray finish that allows the natural tones and characteristics of the wood to show through.	Maple ✓ Cherry N/A	15%	✓	✓	✓
Stains with Flooded Glazes	<b>Black Forest</b>	A two tone finish. A medium toned finish that is highlighted with a dark glaze.	✓	12%	✓	N/A	✓
	<b>Coffee</b>	A two tone finish. Dark glaze over a warmer toner that emulates a soft, Old World look and enhances the door profiles.	✓	12%	✓	N/A	✓
	<b>Palomino</b>	A two tone finish. A light toned finish that is highlighted with a dark espresso glaze. The glaze is meant to be seen primarily in the profiled areas and has minimal affect to the overall color.	✓	12%	✓	N/A	✓
	<b>Whiskey Black</b>	A warm finish with a rich dark patina to create a true reproduction of a period style antique.	✓	12%	✓	N/A	✓
Paints*	<b>Black</b>	True black	N/A	7% or 15%	✓	✓	N/A
	<b>Cloud</b>	Medium gray	✓	5% or 12%	✓	N/A	N/A
	<b>Coconut</b>	Creamy off white	✓	5% or 12%	N/A	N/A	N/A
	<b>Dover</b>	White with a taupe undertone	✓	5% or 12%	N/A	N/A	N/A
	<b>Egret</b>	Light taupe with gray/green undertones	✓	5% or 12%	✓	N/A	N/A
	<b>Icy Avalanche</b>	Cool white with gray undertones	✓	7% or 15%	N/A	N/A	N/A
	<b>Limestone</b>	Light gray	✓	7% or 15%	✓	N/A	N/A
	<b>Maritime</b>	Dark navy with gray/green undertones	✓	7% or 15%	✓	✓	N/A
	<b>Moonstone</b>	Cool dark gray	✓	7% or 15%	✓	✓	N/A
	<b>White</b>	Bright, pure white	✓	7% or 15%	N/A	N/A	N/A
Flooded Glazes for Paints*	<b>Amaretto Crème</b>	Dark brown glaze available on Cloud, Coconut, Dover, Egret, Icy Avalanche, Limestone, Maritime, and Moonstone.	✓	15%	✓	✓***	N/A
	<b>Grey Stone</b>	Gray glaze available on Cloud, Coconut, Dover, Egret, Icy Avalanche, Limestone, and Maritime.	✓	15%	✓	✓***	N/A
	<b>Toasted Almond</b>	Medium brown glaze available on Cloud, Coconut, Dover, Egret, Icy Avalanche, Limestone, Maritime, and Moonstone.	✓	15%	✓	✓***	N/A

<sup>▲</sup>In Trademark construction, cabinets will have matching laminate ends. Where not available, ends will be Natural Maple laminate and a finished end treatment would be needed for an exposed end.

\*On wood products, normal movement is typical due to change in climatic conditions. This will cause hairline cracks at stile, rail and panel joints. This hairline cracking is a normal characteristic of painted finishes and will not be considered a reason for product replacement. Finish agreement required, see page 602.

\*\*Cabinet list includes cabinet price plus any modifications except APC, ET, and PE.

\*\*\*Available on Maritime and Moonstone only.

## UNFINISHED

OPTION NAME	DESCRIPTION/LIMITATIONS	UPCHARGE	DISTRESSING AVAILABILITY	HEIRLOOMING AVAILABILITY
<b>Unfinished</b>	Must upgrade to PE or APC. When cabinets are finished by an outside source, finish is not covered under warranty. Interiors of cabinets will be Natural Maple laminate for PE and clear coated veneer for APC. For finishable interiors, MIP must be specified.	Standard	✓	N/A

## FINISH TECHNIQUES















OPTION NAME	DESCRIPTION	UPCHARGE
<b>Distressing</b>	Provides a rustic look through the carefully crafted application of distressing characteristics such as dents, wormholes, chisel marks, and other signs of wear on solid-wood doors, drawer fronts, face frames, and <b>selected</b> trim items (veneer parts will not be distressed). The distressing technique creates a finish with unique and appealing imperfections, similar to those of time-worn antiques. Distressing characteristics are more visible with glaze finishes (face frames and trim items without detailed profiles will not feature glaze hang-up on distressed areas). When applied to a design in 20/20, all items in the order will receive the distressing upcharge. Not available to order with Coconut, Dover, Icy Avalanche, and White. Not available on MDF.	5% + any applicable premium finish upcharge
<b>Heirlooming</b>	Available on select finishes. The finish will be sanded through the base coat to expose the surface of the wood. This type of sand through on the edges and profiles creates a naturally worn appearance. If a finish is chosen with a glaze, the glaze will be applied after the sanding has been done. This will enhance those areas of exposed wood to take on the darker characteristic of the applied glaze. Not available on Carmin, Harwell, Prestley, and Rivali.  Select trim pieces will feature Heirlooming characteristics. See Trim section for availability.	5% + any applicable premium finish upcharge

## SHEEN OPTION

OPTION NAME	DESCRIPTION	UPCHARGE
<b>Matte Sheen</b>	Available on Stains and Stains with Flooded Glazes.  Replaces standard top coat with a low sheen, non-pigmented top coat on doors, drawer fronts, face frames, trim items, and veneer finished cabinet components in selected finish. Does not affect laminate or clear finished components.	No Upcharge



# FINISH AVAILABILITY

		MAPLE																																			
		Matching Laminate Ends <sup>▲</sup>	Upcharge	Heirloom <sup>*</sup> 	Ainsley	Asbury	Banbury	Brantley	Brinkman	Campbell	Carmin	Denton	Edmond	Elston	Fletcher	Galena	Galvyn 	Harwell 	Huxley 	Ingalls	Jarret	Kayes 	Kennedy	Lainey 	Lorrand 	Morgan 	Natcher 	Parker	Patmore	Pleasant Hill	Prestley 	Rivali 	Seaton	Whittaker 	Willet 		
Paints with Flooded Glazes 	Cloud w/Amaretto Crème	✓	15%		✓	✓	✓	✓	✓	✓	✓	✓	✓	✓	✓	✓	✓	✓	✓	✓	✓	✓	✓	✓	✓	✓	✓	✓	✓	✓	✓	✓	✓	✓	✓	✓	
	Cloud w/Grey Stone	✓	15%		✓	✓	✓	✓	✓	✓	✓	✓	✓	✓	✓	✓	✓	✓	✓	✓	✓	✓	✓	✓	✓	✓	✓	✓	✓	✓	✓	✓	✓	✓	✓	✓	
	Cloud w/Toasted Almond	✓	15%		✓	✓	✓	✓	✓	✓	✓	✓	✓	✓	✓	✓	✓	✓	✓	✓	✓	✓	✓	✓	✓	✓	✓	✓	✓	✓	✓	✓	✓	✓	✓	✓	
	Coconut w/Amaretto Crème	✓	15%		✓	✓	✓	✓	✓	✓	✓	✓	✓	✓	✓	✓	✓	✓	✓	✓	✓	✓	✓	✓	✓	✓	✓	✓	✓	✓	✓	✓	✓	✓	✓	✓	
	Coconut w/Grey Stone	✓	15%		✓	✓	✓	✓	✓	✓	✓	✓	✓	✓	✓	✓	✓	✓	✓	✓	✓	✓	✓	✓	✓	✓	✓	✓	✓	✓	✓	✓	✓	✓	✓	✓	
	Coconut w/Toasted Almond	✓	15%		✓	✓	✓	✓	✓	✓	✓	✓	✓	✓	✓	✓	✓	✓	✓	✓	✓	✓	✓	✓	✓	✓	✓	✓	✓	✓	✓	✓	✓	✓	✓	✓	
	Dover w/Amaretto Crème	✓	15%		✓	✓	✓	✓	✓	✓	✓	✓	✓	✓	✓	✓	✓	✓	✓	✓	✓	✓	✓	✓	✓	✓	✓	✓	✓	✓	✓	✓	✓	✓	✓	✓	
	Dover w/Grey Stone	✓	15%		✓	✓	✓	✓	✓	✓	✓	✓	✓	✓	✓	✓	✓	✓	✓	✓	✓	✓	✓	✓	✓	✓	✓	✓	✓	✓	✓	✓	✓	✓	✓	✓	
	Dover w/Toasted Almond	✓	15%		✓	✓	✓	✓	✓	✓	✓	✓	✓	✓	✓	✓	✓	✓	✓	✓	✓	✓	✓	✓	✓	✓	✓	✓	✓	✓	✓	✓	✓	✓	✓	✓	
	Egret w/Amaretto Crème	✓	15%		✓	✓	✓	✓	✓	✓	✓	✓	✓	✓	✓	✓	✓	✓	✓	✓	✓	✓	✓	✓	✓	✓	✓	✓	✓	✓	✓	✓	✓	✓	✓	✓	✓
	Egret w/Grey Stone	✓	15%		✓	✓	✓	✓	✓	✓	✓	✓	✓	✓	✓	✓	✓	✓	✓	✓	✓	✓	✓	✓	✓	✓	✓	✓	✓	✓	✓	✓	✓	✓	✓	✓	✓
	Egret w/Toasted Almond	✓	15%		✓	✓	✓	✓	✓	✓	✓	✓	✓	✓	✓	✓	✓	✓	✓	✓	✓	✓	✓	✓	✓	✓	✓	✓	✓	✓	✓	✓	✓	✓	✓	✓	✓
	Icy Avalanche w/Amaretto Crème	✓	15%		✓	✓	✓	✓	✓	✓	✓	✓	✓	✓	✓	✓	✓	✓	✓	✓	✓	✓	✓	✓	✓	✓	✓	✓	✓	✓	✓	✓	✓	✓	✓	✓	✓
	Icy Avalanche w/Grey Stone	✓	15%		✓	✓	✓	✓	✓	✓	✓	✓	✓	✓	✓	✓	✓	✓	✓	✓	✓	✓	✓	✓	✓	✓	✓	✓	✓	✓	✓	✓	✓	✓	✓	✓	✓
	Icy Avalanche w/Toasted Almond	✓	15%		✓	✓	✓	✓	✓	✓	✓	✓	✓	✓	✓	✓	✓	✓	✓	✓	✓	✓	✓	✓	✓	✓	✓	✓	✓	✓	✓	✓	✓	✓	✓	✓	✓
	Limestone w/Amaretto Crème	✓	15%		✓	✓	✓	✓	✓	✓	✓	✓	✓	✓	✓	✓	✓	✓	✓	✓	✓	✓	✓	✓	✓	✓	✓	✓	✓	✓	✓	✓	✓	✓	✓	✓	✓
	Limestone w/Grey Stone	✓	15%		✓	✓	✓	✓	✓	✓	✓	✓	✓	✓	✓	✓	✓	✓	✓	✓	✓	✓	✓	✓	✓	✓	✓	✓	✓	✓	✓	✓	✓	✓	✓	✓	✓
	Limestone w/Toasted Almond	✓	15%		✓	✓	✓	✓	✓	✓	✓	✓	✓	✓	✓	✓	✓	✓	✓	✓	✓	✓	✓	✓	✓	✓	✓	✓	✓	✓	✓	✓	✓	✓	✓	✓	✓
Maritime w/Amaretto Crème	✓	15%	5%	✓	✓	✓	✓	✓	✓	✓	✓	✓	✓	✓	✓	✓	✓	✓	✓	✓	✓	✓	✓	✓	✓	✓	✓	✓	✓	✓	✓	✓	✓	✓	✓	✓	
Maritime w/Grey Stone	✓	15%	5%	✓	✓	✓	✓	✓	✓	✓	✓	✓	✓	✓	✓	✓	✓	✓	✓	✓	✓	✓	✓	✓	✓	✓	✓	✓	✓	✓	✓	✓	✓	✓	✓	✓	
Maritime w/Toasted Almond	✓	15%	5%	✓	✓	✓	✓	✓	✓	✓	✓	✓	✓	✓	✓	✓	✓	✓	✓	✓	✓	✓	✓	✓	✓	✓	✓	✓	✓	✓	✓	✓	✓	✓	✓	✓	
Moonstone w/Amaretto Crème	✓	15%	5%	✓	✓	✓	✓	✓	✓	✓	✓	✓	✓	✓	✓	✓	✓	✓	✓	✓	✓	✓	✓	✓	✓	✓	✓	✓	✓	✓	✓	✓	✓	✓	✓	✓	
Moonstone w/Toasted Almond	✓	15%	5%	✓	✓	✓	✓	✓	✓	✓	✓	✓	✓	✓	✓	✓	✓	✓	✓	✓	✓	✓	✓	✓	✓	✓	✓	✓	✓	✓	✓	✓	✓	✓	✓	✓	
Distressing Technique	Distressing		5% <sup>†</sup>		✓ <sup>1</sup>	✓ <sup>1</sup>			✓ <sup>1</sup>	✓ <sup>1</sup>			✓ <sup>1</sup>			✓ <sup>1</sup>																					

\*Heirloom upcharge is in addition to other finish upcharges. Heirloom not available on Carmin, Harwell, Prestley, and Rivali.  
 ▲In Trademark construction, cabinets will have matching laminate ends. Where not available, ends will be Natural Maple laminate and a finished end treatment would be needed for an exposed end.  
 †Distressing upcharge is in addition to other finish upcharges. Distressing not available on Coconut, Dover, Icy Avalanche, or White.  
 Signed finish agreement required, see pages 601-604.













# FINISH AVAILABILITY

			MDF				
		Matching Laminate Ends <sup>▲</sup>	Upcharge	Denton	Elston	Pleasant Hill	Prestley
Paints 	Black		7%	✓	✓	✓	✓
	Cloud	✓	5%	✓	✓	✓	✓
	Coconut	✓	5%	✓	✓	✓	✓
	Dover	✓	5%	✓	✓	✓	✓
	Egret	✓	5%	✓	✓	✓	✓
	Icy Avalanche	✓	7%	✓	✓	✓	✓
	Limestone	✓	7%	✓	✓	✓	✓
	Maritime	✓	7%	✓	✓	✓	✓
	Moonstone	✓	7%	✓	✓	✓	✓
	White	✓	7%	✓	✓	✓	✓

▲ In Trademark construction, cabinets will have matching laminate ends. Where not available, ends will be Natural Maple laminate and a finished end treatment would be needed for an exposed end.  
 Signed finish agreement required, see pages 601-604.









# FINISH AVAILABILITY

		CHERRY																																							
		Matching Laminate Ends <sup>▲</sup>	Upcharge	Heirloom <sup>*</sup> 	Matte Sheen	Asbury	Banbury	Brantley	Brinkman	Campbell	Carmin	Denton	Edmond	Elston	Fletcher	Galena	Galvyn 	Harwell 	Huxley	Jarret	Kayes 	Kennedy 	Lainey 	Morgan 	Natcher 	Parker	Patmore	Pleasant Hill	Prestley 	Rivali 	Seaton	Whittaker 	Willet								
Stains	Buckskin	✓			✓	✓	✓	✓	✓	✓	✓	✓	✓	✓	✓	✓	✓	✓	✓	✓	✓	✓	✓	✓	✓	✓	✓	✓	✓	✓	✓	✓	✓	✓	✓	✓					
	Cattail	✓			✓	✓	✓	✓	✓	✓	✓	✓	✓	✓	✓	✓	✓	✓	✓	✓	✓	✓	✓	✓	✓	✓	✓	✓	✓	✓	✓	✓	✓	✓	✓	✓	✓				
	Chocolate	✓			✓	✓	✓	✓	✓	✓	✓	✓	✓	✓	✓	✓	✓	✓	✓	✓	✓	✓	✓	✓	✓	✓	✓	✓	✓	✓	✓	✓	✓	✓	✓	✓	✓	✓			
	Colt 	✓			✓	✓	✓	✓	✓	✓	✓	✓	✓	✓	✓	✓	✓	✓	✓	✓	✓	✓	✓	✓	✓	✓	✓	✓	✓	✓	✓	✓	✓	✓	✓	✓	✓	✓			
	Grizzly	✓	12%		✓	✓	✓	✓	✓	✓	✓	✓	✓	✓	✓	✓	✓	✓	✓	✓	✓	✓	✓	✓	✓	✓	✓	✓	✓	✓	✓	✓	✓	✓	✓	✓	✓	✓			
	Havana	✓			✓	✓	✓	✓	✓	✓	✓	✓	✓	✓	✓	✓	✓	✓	✓	✓	✓	✓	✓	✓	✓	✓	✓	✓	✓	✓	✓	✓	✓	✓	✓	✓	✓	✓	✓		
	Henna	✓			✓	✓	✓	✓	✓	✓	✓	✓	✓	✓	✓	✓	✓	✓	✓	✓	✓	✓	✓	✓	✓	✓	✓	✓	✓	✓	✓	✓	✓	✓	✓	✓	✓	✓	✓		
	Kodiak	✓	12%		✓	✓	✓	✓	✓	✓	✓	✓	✓	✓	✓	✓	✓	✓	✓	✓	✓	✓	✓	✓	✓	✓	✓	✓	✓	✓	✓	✓	✓	✓	✓	✓	✓	✓	✓		
	Light	✓			✓	✓	✓	✓	✓	✓	✓	✓	✓	✓	✓	✓	✓	✓	✓	✓	✓	✓	✓	✓	✓	✓	✓	✓	✓	✓	✓	✓	✓	✓	✓	✓	✓	✓	✓	✓	
	Morel	✓			✓	✓	✓	✓	✓	✓	✓	✓	✓	✓	✓	✓	✓	✓	✓	✓	✓	✓	✓	✓	✓	✓	✓	✓	✓	✓	✓	✓	✓	✓	✓	✓	✓	✓	✓	✓	
	Natural	✓			✓	✓	✓	✓	✓	✓	✓	✓	✓	✓	✓	✓	✓	✓	✓	✓	✓	✓	✓	✓	✓	✓	✓	✓	✓	✓	✓	✓	✓	✓	✓	✓	✓	✓	✓	✓	✓
	Sahara	✓			✓	✓	✓	✓	✓	✓	✓	✓	✓	✓	✓	✓	✓	✓	✓	✓	✓	✓	✓	✓	✓	✓	✓	✓	✓	✓	✓	✓	✓	✓	✓	✓	✓	✓	✓	✓	✓
	Seal	✓			✓	✓	✓	✓	✓	✓	✓	✓	✓	✓	✓	✓	✓	✓	✓	✓	✓	✓	✓	✓	✓	✓	✓	✓	✓	✓	✓	✓	✓	✓	✓	✓	✓	✓	✓	✓	✓
	Storm		15%	5%	✓	✓	✓	✓	✓	✓	✓	✓	✓	✓	✓	✓	✓	✓	✓	✓	✓	✓	✓	✓	✓	✓	✓	✓	✓	✓	✓	✓	✓	✓	✓	✓	✓	✓	✓	✓	
	Thatch	✓			✓	✓	✓	✓	✓	✓	✓	✓	✓	✓	✓	✓	✓	✓	✓	✓	✓	✓	✓	✓	✓	✓	✓	✓	✓	✓	✓	✓	✓	✓	✓	✓	✓	✓	✓	✓	✓
Tundra	✓			✓	✓	✓	✓	✓	✓	✓	✓	✓	✓	✓	✓	✓	✓	✓	✓	✓	✓	✓	✓	✓	✓	✓	✓	✓	✓	✓	✓	✓	✓	✓	✓	✓	✓	✓	✓	✓	
Unfinished	✓				✓	✓	✓	✓	✓	✓	✓	✓	✓	✓	✓	✓	✓	✓	✓	✓	✓	✓	✓	✓	✓	✓	✓	✓	✓	✓	✓	✓	✓	✓	✓	✓	✓	✓	✓	✓	
Stains with Flooded Glazes	Black Forest	✓	12%		✓	✓	✓	✓	✓	✓	✓	✓	✓	✓	✓	✓	✓	✓	✓	✓	✓	✓	✓	✓	✓	✓	✓	✓	✓	✓	✓	✓	✓	✓	✓	✓	✓	✓	✓		
	Coffee	✓	12%		✓	✓	✓	✓	✓	✓	✓	✓	✓	✓	✓	✓	✓	✓	✓	✓	✓	✓	✓	✓	✓	✓	✓	✓	✓	✓	✓	✓	✓	✓	✓	✓	✓	✓	✓	✓	
	Palomino	✓	12%		✓	✓	✓	✓	✓	✓	✓	✓	✓	✓	✓	✓	✓	✓	✓	✓	✓	✓	✓	✓	✓	✓	✓	✓	✓	✓	✓	✓	✓	✓	✓	✓	✓	✓	✓	✓	
	Whiskey Black	✓	12%		✓	✓	✓	✓	✓	✓	✓	✓	✓	✓	✓	✓	✓	✓	✓	✓	✓	✓	✓	✓	✓	✓	✓	✓	✓	✓	✓	✓	✓	✓	✓	✓	✓	✓	✓	✓	
Distressing Technique	Distressing		5% <sup>†</sup>		✓ <sup>1</sup>			✓ <sup>1</sup>	✓ <sup>1</sup>			✓ <sup>1</sup>			✓ <sup>1</sup>											✓ <sup>1</sup>															

\*Heirloom upcharge is in addition to other finish upcharges. Heirloom not available on Carmin, Harwell, Prestley, and Rivali.  
<sup>▲</sup>In Trademark construction, cabinets will have matching laminate ends. Where not available, ends will be Natural Maple laminate and a finished end treatment would be needed for an exposed end.  
<sup>†</sup>Distressing upcharge is in addition to other finish upcharges.  
 Signed finish agreement required, see pages 601-604.

Cherry laminate components are intentionally slightly darker than cabinet facings at the time of manufacturing to compensate for the expected darkening of doors, drawer fronts, etc., as they are exposed to natural sunlight.

# FINISH AVAILABILITY

		ALDER												RUSTIC ALDER 										
		Matching Laminate Ends <sup>▲</sup>	Upcharge	Heirloom <sup>*</sup> 	Matte Sheen	Brinkman	Chanley	Elston	Galena	Huxley	Ingalis 	Lormand 	Morgan	Pleasant Hill	Brinkman	Chanley	Elston	Huxley	Ingalis 	Lormand 	Morgan	Pleasant Hill		
Stains	Buckskin	✓			✓	✓	✓	✓	✓	✓	✓	✓	✓	✓	✓	✓	✓	✓	✓	✓	✓	✓	✓	
	Cattail	✓			✓	✓	✓	✓	✓	✓	✓	✓	✓	✓	✓	✓	✓	✓	✓	✓	✓	✓	✓	
	Chocolate	✓			✓	✓	✓	✓	✓	✓	✓	✓	✓	✓	✓	✓	✓	✓	✓	✓	✓	✓	✓	
	Colt 	✓			✓	✓	✓	✓	✓	✓	✓	✓	✓	✓	✓	✓	✓	✓	✓	✓	✓	✓	✓	
	Grizzly	✓	12%		✓	✓	✓	✓	✓	✓	✓	✓	✓	✓	✓	✓	✓	✓	✓	✓	✓	✓	✓	
	Havana	✓			✓	✓	✓	✓	✓	✓	✓	✓	✓	✓	✓	✓	✓	✓	✓	✓	✓	✓	✓	✓
	Kodiak	✓	12%		✓	✓	✓	✓	✓	✓	✓	✓	✓	✓	✓	✓	✓	✓	✓	✓	✓	✓	✓	✓
	Morel	✓			✓	✓	✓	✓	✓	✓	✓	✓	✓	✓	✓	✓	✓	✓	✓	✓	✓	✓	✓	✓
	Natural	✓			✓	✓	✓	✓	✓	✓	✓	✓	✓	✓	✓	✓	✓	✓	✓	✓	✓	✓	✓	✓
	Sahara	✓			✓	✓	✓	✓	✓	✓	✓	✓	✓	✓	✓	✓	✓	✓	✓	✓	✓	✓	✓	✓
	Seal	✓			✓	✓	✓	✓	✓	✓	✓	✓	✓	✓	✓	✓	✓	✓	✓	✓	✓	✓	✓	✓
	Thatch	✓			✓	✓	✓	✓	✓	✓	✓	✓	✓	✓	✓	✓	✓	✓	✓	✓	✓	✓	✓	✓
	Tundra	✓			✓	✓	✓	✓	✓	✓	✓	✓	✓	✓	✓	✓	✓	✓	✓	✓	✓	✓	✓	✓
	Unfinished	✓				✓	✓	✓	✓	✓	✓	✓	✓	✓	✓	✓	✓	✓	✓	✓	✓	✓	✓	✓
Stains with Flooded Glazes	Black Forest	✓	12%		✓	✓	✓	✓	✓	✓	✓	✓	✓	✓	✓	✓	✓	✓	✓	✓	✓	✓	✓	
	Coffee	✓	12%		✓	✓	✓	✓	✓	✓	✓	✓	✓	✓	✓	✓	✓	✓	✓	✓	✓	✓	✓	
	Palomino	✓	12%		✓	✓	✓	✓	✓	✓	✓	✓	✓	✓	✓	✓	✓	✓	✓	✓	✓	✓	✓	
	Whiskey Black	✓	12%		✓	✓	✓	✓	✓	✓	✓	✓	✓	✓	✓	✓	✓	✓	✓	✓	✓	✓	✓	
Distressing Technique	Distressing		5% <sup>†</sup>		✓ <sup>†</sup>	✓ <sup>†</sup>		✓ <sup>†</sup>						✓ <sup>†</sup>	✓ <sup>†</sup>									















\*Heirloom upcharge is in addition to other finish upcharges.

▲In Trademark construction, cabinets will have matching laminate ends. Where not available, ends will be Natural Maple laminate and a finished end treatment would be needed for an exposed end.

†Distressing upcharge is in addition to other finish upcharges.

 Signed finish agreement required, see pages 601-604.

# FINISH AVAILABILITY



						RUSTIC HICKORY 										OAK											
		Matching Laminate Ends <sup>▲</sup>	Upcharge	Heirloom <sup>*</sup> 	Matte Sheen	Brinkman	Campbell 	Edmond 	Elston	Huxley	Ingalls 	Lormand 	Morgan	Pleasant Hill	Willet 	Brinkman	Edmond	Elston	Galvyn 	Harwell 	Huxley	Ingalls 	Lormand 	Patmore	Willet 		
Stains	Buckskin	✓			✓	✓	✓	✓	✓	✓	✓	✓	✓	✓	✓	✓	✓	✓	✓	✓	✓	✓	✓	✓	✓	✓	
	Chocolate	✓			✓											✓	✓	✓	✓	✓	✓	✓	✓	✓	✓	✓	
	Colt 	✓			✓	✓	✓	✓	✓	✓	✓	✓	✓	✓	✓	✓	✓	✓	✓	✓	✓	✓	✓	✓	✓	✓	
	Grizzly	✓	12%		✓	✓	✓	✓	✓	✓	✓	✓	✓	✓	✓	✓	✓	✓	✓	✓	✓	✓	✓	✓	✓	✓	
	Havana	✓			✓	✓	✓	✓	✓	✓	✓	✓	✓	✓	✓	✓	✓	✓	✓	✓	✓	✓	✓	✓	✓	✓	
	Kodiak	✓	12%		✓	✓	✓	✓	✓	✓	✓	✓	✓	✓	✓	✓	✓	✓	✓	✓	✓	✓	✓	✓	✓	✓	
	Light	✓			✓	✓	✓	✓	✓	✓	✓	✓	✓	✓	✓	✓	✓	✓	✓	✓	✓	✓	✓	✓	✓	✓	
	Morel	✓			✓	✓	✓	✓	✓	✓	✓	✓	✓	✓	✓	✓	✓	✓	✓	✓	✓	✓	✓	✓	✓	✓	✓
	Natural	✓			✓	✓	✓	✓	✓	✓	✓	✓	✓	✓	✓	✓	✓	✓	✓	✓	✓	✓	✓	✓	✓	✓	✓
	Sahara	✓			✓	✓	✓	✓	✓	✓	✓	✓	✓	✓	✓	✓	✓	✓	✓	✓	✓	✓	✓	✓	✓	✓	✓
	Seal	✓			✓	✓	✓	✓	✓	✓	✓	✓	✓	✓	✓	✓	✓	✓	✓	✓	✓	✓	✓	✓	✓	✓	✓
	Thatch	✓			✓	✓	✓	✓	✓	✓	✓	✓	✓	✓	✓	✓	✓	✓	✓	✓	✓	✓	✓	✓	✓	✓	✓
	Tundra	✓			✓	✓	✓	✓	✓	✓	✓	✓	✓	✓	✓	✓	✓	✓	✓	✓	✓	✓	✓	✓	✓	✓	✓
	Unfinished	✓				✓	✓	✓	✓	✓	✓	✓	✓	✓	✓	✓	✓	✓	✓	✓	✓	✓	✓	✓	✓	✓	✓
Stains with Flooded Glazes	Black Forest	✓	12%		✓											✓	✓	✓	✓	✓	✓	✓	✓	✓	✓	✓	
	Coffee	✓	12%		✓	✓	✓	✓	✓	✓	✓	✓	✓	✓	✓												
	Palomino	✓	12%		✓											✓	✓	✓	✓	✓	✓	✓	✓	✓	✓	✓	
Paints	Black 		15%	5%											✓	✓	✓	✓	✓	✓	✓	✓	✓	✓	✓	✓	
Distressing Technique	Distressing		5% <sup>†</sup>			✓ <sup>†</sup>	✓ <sup>†</sup>	✓ <sup>†</sup>								✓ <sup>†</sup>	✓ <sup>†</sup>										





\*Heirloom upcharge is in addition to other finish upcharges. Available on Oak only.

▲ In Trademark construction, cabinets will have matching laminate ends. Where not available, ends will be Natural Maple laminate and a finished end treatment would be needed for an exposed end.

† Distressing upcharge is in addition to other finish upcharges.

 Signed finish agreement required, see pages 601-604.

FINISH AVAILABILITY					
DOOR COLOR AVAILABILITY		PURESTYLE™	SPECIALTY LAMINATES		
		Herra	Aspen	Derazi	Gallio
Non-Textured	Antler				✓
	Icy Avalanche Linea Nightfall 	✓			✓
Textured	Arctic			✓	
	Elk	✓			✓
	Gunstock 	✓			✓
	Obsidian			✓	
	Wharf				✓
High Gloss	White w/Matching Edgebanding		✓		
	White w/Metallic Edgebanding		✓		

CABINET COLOR AVAILABILITY		Matching Laminate Ends <sup>4</sup>	DOOR COLOR AVAILABILITY							
			Antler	Arctic	Elk	Gunstock 	High Gloss White	Icy Avalanche Linea Nightfall 	Obsidian	Wharf
Stains	Chocolate Cherry 	✓				✓				
	Chocolate Maple 	✓				✓				
	Chocolate Oak 	✓				✓				
	Morel Cherry	✓	✓							
	Morel Maple	✓	✓							
	Morel Oak	✓	✓							
	Seal Maple	✓			✓					
	Seal Oak	✓			✓					
	Storm Maple	✓							✓	
	Thatch Cherry	✓				✓				
	Thatch Maple	✓			✓	✓				
	Thatch Oak	✓			✓	✓				
Paints	Black								✓	
	Cloud	✓	✓	✓						
	Dover	✓	✓	✓						✓
	Icy Avalanche	✓		✓				✓		
	Limestone	✓	✓							✓
	White	✓	✓	✓			✓			✓

<sup>4</sup>In Trademark construction, cabinets will have matching laminate end to match the cabinet box color. Where not available, ends will be Natural Maple laminate and a finished end treatment would be needed for an exposed end.

# CONSTRUCTION FEATURES

	TRADEMARK (TMK)	PLYWOOD ENDS (PE)*	ALL-PLYWOOD CONSTRUCTION (APC)*
<b>Doors &amp; Drawer Fronts</b>	See "Door Styles" pages 12-29 for door and drawer front configuration and construction details.		
<b>Face Frames</b>	3/4" solid hardwood.		
<b>I-beam Braces</b>	3/8" furniture board dadoed into face frame, end panels and back panels.		3/8" plywood dadoed into face frame, end panels and back panels.
<b>Cabinet Sides</b>	1/2" furniture board with Natural Maple laminate interiors. Exteriors are laminate that match the color of the face frame, with exception of Black and Cherry Storm.	1/2" unfinished veneer plywood with Natural Maple laminate interiors.	1/2" unfinished plywood with clear coated veneer interior.**▲
	Optional Furniture Finished Plywood Ends (FPEB) modification: Cabinets will have 3/4" finished veneer end panels to achieve a Furniture End appearance. See page 45 for more details.		
<b>Cabinet Tops &amp; Bottoms (Wall &amp; Tall)</b>	3/8" furniture board with Natural Maple laminate interior and exterior surfaces.		3/8" plywood with clear coated veneer interior and exterior.**▲
<b>Cabinet Bottoms (Base &amp; Vanity)</b>	3/8" furniture board with Natural Maple laminate interior surface.		3/8" plywood with clear coated veneer interior.**▲
<b>Cabinet Backs</b>	3/8" furniture board with Natural Maple laminate interior. Base cabinets have 3mm system holes for easy drawer and tray installation.		3/8" plywood with clear coated veneer interior.**▲ Base cabinets have 3mm system holes for easy drawer and tray installation.
<b>Adjustable Shelves</b>	3/4" furniture board with Natural Maple laminate to match interiors. Shelves are adjustable in wall and base cabinets unless otherwise noted.		3/4" plywood with clear coated veneer to match interiors.** Shelves are adjustable in wall and base cabinets.
<b>Finish</b>	Multi-step finishing process where the finished components are sanded, stained, and sealed before a catalyzed top coat is applied.		
<b>Hinges</b>	Quick-Release™ fully concealed, 6-way adjustable cup hinge features push tab for easy removal, deactivation option, and <b>Smart Stop™ self-closing feature</b> . Select cabinets feature a 170° or 107° 4-way adjustable hinge. See page 590 for details.		
<b>Drawer Box and Roll Tray Construction</b>	All Styles: Four-sided clear coated hardwood. Corners are dovetailed and glued. Drawer bottom is 5.2mm laminated plywood fully captured in box sides, front and back.		
<b>Drawer and Roll Tray Guide</b>	Double fully concealed, ball bearing, self-aligning, full extension guide with <b>Smart Stop™ self-closing mechanism</b> and fast clip removal system. Smart Stop engages when the drawer or roll tray is approximately 2" from closing, applying resistance to the self-closing mechanism. Optional (Roll Trays): EasyTrax™ (ET) height adjustment system. All guides have a maximum weight capacity of 90 lbs. Drawers and roll trays have a maximum weight capacity of 15 lbs. per square foot.		
<b>Toekick</b>	Unfinished furniture board toekick to allow application of finished toeboard materials. A variety of laminate and wood toeboard skins and baseboard mouldings available in 8' lengths; see ACCESSORIES section. When APC is selected, toekick will be plywood.		
<b>Warranty</b>	Schrock has a Limited Lifetime Warranty. For terms and conditions, please visit: <a href="https://www.schrock.com/warranty">https://www.schrock.com/warranty</a>		
<b>Interior Cabinet Components</b>	A few interior components are manufactured from laminated furniture board because they provide for the most durable, aesthetic application. Some examples include the BCFW48SP (swing-out shelf), SLS33/36 (fixed shelf), and PY18/36 (swing-out and door mounted racks).		

### TRADEMARK CABINET CONSTRUCTION

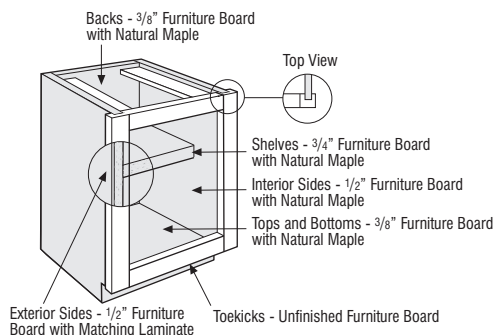

See page 41 for Plywood Ends and All-plywood Construction.

### TRADEMARK DRAWER CONSTRUCTION

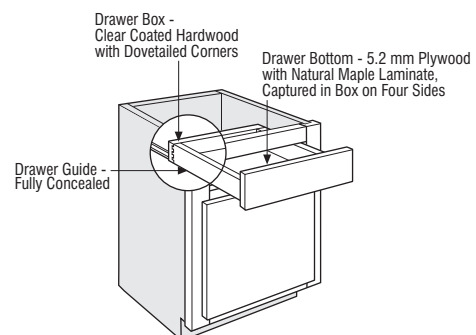

See page 41 for Plywood Ends and All-plywood Construction.

\*All-plywood components meet ANSI/HPVA HP-1 standards and may contain MDF or particleboard.

\*\*White Laminate Interior (WLI) modification is available on White cabinets to replace the clear coated veneer with White laminate.

▲ Cabinets with limited interior visibility, such as Drawer Bases (2DB., 3DB., 4DB.), appliance cabinets without doors, and others may have a laminated plywood cabinet interior.



## CONSTRUCTION UPGRADES

See page 40 for modification compatibility. Each modification will be priced accordingly. Requests for non-published modifications may be treated as a Special Sales Order which will require feasibility, pricing and leadtime review and approval. Please check with your customer service representative before placing your order.

OPTION NAME	APPLICABLE CABINET GROUP	DESCRIPTION/LIMITATIONS	PRICING
<b>Plywood Ends (PE)**</b>	Most cabinets with sides	Replaces standard cabinet ends with unfinished 1/2" plywood exterior ends. See page 39 for more details.	Cabinet list + 5%*
<b>All-plywood Construction (APC)**</b>	Most cabinets with sides	Replaces standard cabinet construction with plywood for 1/2" ends, 3/4" shelves, and 3/8" top, bottom, and back. Exterior of cabinet ends are unfinished. Cabinet interior and exterior of top and bottom are clear coated veneer***. See page 39 for more details.  White Laminate Interior (WLI) modification available on White cabinets (painted White or Laminate) in APC, see page 46.	Cabinet list + 10%
	Selected trim panels	Replaces standard panel material with plywood. Exterior side is finished. Interior side is clear coated veneer.	List + 10%

### PLYWOOD ENDS CONSTRUCTION UPGRADE (PE)

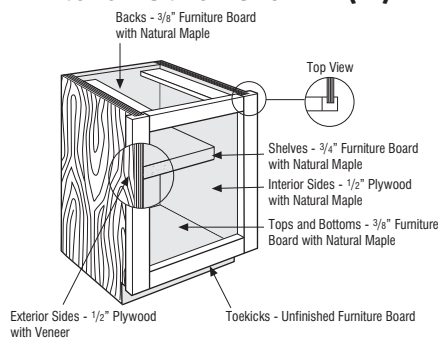

### ALL-PLYWOOD CONSTRUCTION UPGRADE (APC)

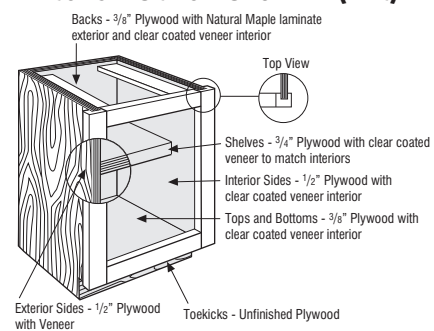

\*When a cabinet is specified with FPEB in a design where PE has been selected for the entire kitchen (through Styles & Pricing Tab and Construction Options menu), both modification charges will apply. To avoid the additional charge for PE, use attachments to specify PE for all other cabinets instead of selecting it for the entire kitchen.

\*\*All-plywood components meet ANSI/HPVA HP-1 standards and may contain MDF or particleboard.

\*\*\*Cabinets with limited interior visibility, such as Drawer Bases (2DB., 3DB., 4DB.), appliance cabinets without doors, and others may have a laminated plywood cabinet interior.

## THINGS TO REMEMBER ABOUT FINISHED ENDS AND CABINET INTERIOR FINISHES

On cabinets with PLYWOOD ENDS (PE) or ALL-PLYWOOD CONSTRUCTION (APC) modifications, cabinet sides are plywood with an unfinished veneer exterior. You can finish the exposed ends in your kitchen with one of several decorative options, as follows:

1. Leave the ends UNFINISHED if the cabinets are installed against each other or against the wall.
2. Purchase a 1/4" VENEER SKIN for field installation. This brings the cabinet side flush with the face frame.
3. Specify FURNITURE FINISHED PLYWOOD ENDS (FPEB). See page 45 for details.
4. Specify AUTHENTIC ENDS (AUTHL or AUTHR) or Face Frame and Door on End (FFDL or FFDR). See page 45 for details.
5. Specify cabinets with FINISHED ENDS (FB), factory installed. Both ends of the cabinet use 1/2" plywood veneer panel that is factory finished on the exterior to match the door and frame.
6. Purchase Wall, Base or Tall END DECORATIVE DOOR PANELS (WED, BED, TED). These are a skin and a door that can be attached to finish the exposed end. This will extend the total cabinet run by the thickness of the door.
7. Purchase a Wall MESSAGE CENTER.
8. Cabinets specified with MIP have matching veneer interior and exterior. Some cabinets are provided with standard MIP construction, such as:
  - Wine Rack Cabinets
  - WOC - Wall Open Cabinets
  - Wall China Display Cabinets
  - Bookcase Cabinets
  - BOC, BOD - Base Open Cabinets
9. All Wall Organizer and Wall/Base Spice Drawer Cabinets are frameless doweled construction and feature 3/4" furniture board with matching finished veneer interior and exterior.

# DRAWER FRONT UPGRADES

See page 40 for modification compatibility. Each modification will be priced accordingly. Requests for non-published modifications may be treated as a Special Sales Order which will require feasibility, pricing and leadtime review and approval. Please check with your customer service representative before placing your order.

OPTION NAME	APPLICABLE CABINET GROUP	DESCRIPTION/LIMITATIONS	PRICING
<b>Drawer Front Flat 5-piece (DFF5PC)</b>	Base, tall, and vanity cabinets on Carmin, Elston, Galena, Huxley, Ingalis, Kayes, Morgan, Whittaker, and Willet	Replaces the standard drawer front with a 5-piece drawer front (see images with applicable door styles). Must upgrade all drawer fronts on a cabinet where applicable. Premium finish and finish technique upcharges will apply where applicable. See page 82 for 5-piece drawer front dimensions when specifying decorative hardware.	\$105 list per drawer front
<b>Drawer Front Raised 5-piece (DFR5PC)</b>	Base, tall, and vanity cabinets on Chanley and Parker	Replaces the standard drawer front with a 5-piece drawer front (see images with applicable door styles). Must upgrade all drawer fronts on a cabinet where applicable. Premium finish and finish technique upcharges will apply where applicable. See page 82 for 5-piece drawer front dimensions when specifying decorative hardware.	\$105 list per drawer front
<b>Drawer Front Slab (DFSLB)</b>	Base, tall, and vanity cabinets on Ainsley, Campbell, Denton, Jarret, Kennedy, Pleasant Hill, and Seaton	Replaces standard drawer front with slab drawer front. Must upgrade all drawer fronts on cabinet where applicable.	No Upcharge

## DRAWER FRONT FLAT 5-PIECE (DFF5PC)



Carmin

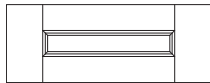

Kayes



Elston

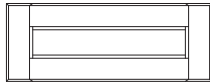

Morgan

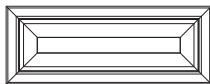

Galena\*

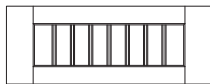

Whittaker

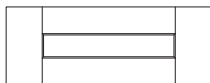

Huxley



Willet

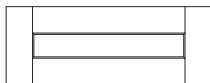

Ingalis

\*Galena 5-piece 6 1/4" and 6 3/4" high drawer fronts have a flat center panel, 10" and taller drawer fronts have a raised center panel.

## DRAWER FRONT RAISED 5-PIECE (DFR5PC)

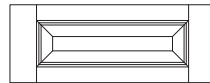

Chanley



Parker

## DRAWER FRONT SLAB (DFSLB)

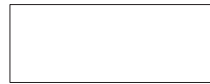

Ainsley  
Campbell  
Denton



Jarret

Kennedy  
Pleasant Hill  
Seaton



## DRAWER FRONT OPTIONS

See page 40 for modification compatibility. Each modification will be priced accordingly. Requests for non-published modifications may be treated as a Special Sales Order which will require feasibility, pricing and leadtime review and approval. Please check with your customer service representative before placing your order.

OPTION NAME	APPLICABLE CABINET GROUP	DESCRIPTION/LIMITATIONS	PRICING
<b>Drawer Front Flat 5-piece with Slab Top (DFF5PCSLBT)</b>	Base, tall, and vanity cabinets on Carmin, Elston, Galena, Huxley, Ingalls, Kayes, Morgan, Whittaker, and Willet	<p>Replaces the standard slab drawer fronts with a 5-piece flat center panel drawer front with the exception of the top drawer front of base and vanity cabinets when the face frame opening is 5" high, which will remain slab (see images with applicable door styles). Drawer front will be slab on Tall Built-in Microwave (TBMWB..) and Single Oven Cabinets (OSB..).</p> <p>Not available on Wall Two Drawer (W2D..) and Furniture Drawer 6 3/4" High (FD..6.75..). Use DFF5PC for a 5-piece drawer front on these cabinets where DFF5PCSLBT is not available.</p> <p>Not compatible with Inverted Frame (INVERM) modification.</p> <p>Must upgrade all drawer fronts on a cabinet where applicable. Upcharge for 5-piece drawer front is not applied to slab drawer fronts.</p> <p>Premium finish and finish technique upcharges will apply where applicable.</p> <p>See page 82 for 5-piece drawer front dimensions when specifying decorative hardware.</p>	\$105 list per 5-piece drawer front
<b>Drawer Front Raised 5-piece with Slab Top (DFR5PCSLBT)</b>	Base, tall, and vanity cabinets on Chanley and Parker	<p>Replaces the standard slab drawer fronts with a 5-piece raised center panel drawer front with the exception of the top drawer front of base and vanity cabinets when the face frame opening is 5" high, which will remain slab (see images with applicable door styles). Drawer front will be slab on Tall Built-in Microwave (TBMWB..) and Single Oven Cabinets (OSB..).</p> <p>Not available on Wall Two Drawer (W2D..) and Furniture Drawer 6 3/4" High (FD..6.75..). Use DFR5PC for a 5-piece drawer front on these cabinets where DFR5PCSLBT is not available.</p> <p>Not compatible with Inverted Frame (INVERM) modification.</p> <p>Must upgrade all drawer fronts on a cabinet where applicable. Upcharge for 5-piece drawer front is not applied to slab drawer fronts.</p> <p>Premium finish and finish technique upcharges will apply where applicable.</p> <p>See page 82 for 5-piece drawer front dimensions when specifying decorative hardware.</p>	\$105 list per 5-piece drawer front
<b>Drawer Front Slab Top (DFSLBT)</b>	Base, tall, and vanity cabinets on Ainsley, Campbell, Denton, Jarret, Kennedy, Pleasant Hill, and Seaton	<p>Replaces the 5-piece top drawer front of base and vanity cabinets with a slab drawer front when the face frame opening is 5" high. The remaining drawer fronts will remain 5-piece (see images with applicable door styles). Drawer front will be slab on Tall Built-in Microwave (TBMWB..) and Single Oven Cabinets (OSB..).</p> <p>Not available on Wall Two Drawer (W2D..) and Furniture Drawer 6 3/4" High (FD..6.75..).</p> <p>Not compatible with Inverted Frame (INVERM) modification.</p> <p>Must upgrade all drawer fronts on a cabinet where applicable.</p> <p>Premium finish and finish technique upcharges will apply where applicable.</p> <p>See page 82 for 5-piece drawer front dimensions when specifying decorative hardware.</p>	No Upcharge

**DRAWER FRONT FLAT 5-PIECE WITH SLAB TOP (DFF5PCSLBT)**

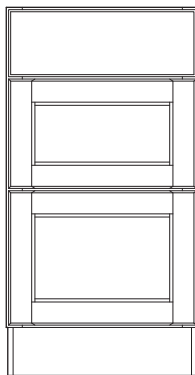

**DRAWER FRONT RAISED 5-PIECE WITH SLAB TOP (DFR5PCSLBT)**

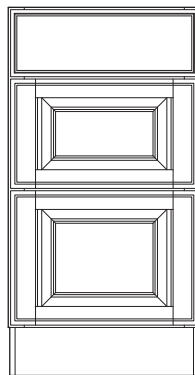

**DRAWER FRONT SLAB TOP (DFSLBT)**

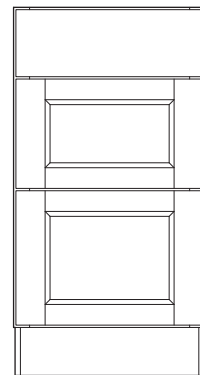

# DRAWER AND DOOR OPTIONS

See page 40 for modification compatibility. Each modification will be priced accordingly. Requests for non-published modifications may be treated as a Special Sales Order which will require feasibility, pricing and leadtime review and approval. Please check with your customer service representative before placing your order.

OPTION NAME	APPLICABLE CABINET GROUP	DESCRIPTION/LIMITATIONS	PRICING
<b>Door Panel - Solid Reverse Raised (DPSRR)</b>	Most cabinets with doors; available on Pleasant Hill only	Replaces Pleasant Hill veneer flat door center panel with a solid reverse raised center panel. Drawer fronts are not affected by this door option. Center panels in Paint and Paint with Glaze finishes will be reverse raised MDF. Not available on Pleasant Hill MDF.	\$84 list per door
<b>Modified Full Overlay (MFO)</b>	Most wall and tall cabinets and some panels with doors	Reduces the size of a Full Overlay door by 3/4" allowing for a top face frame reveal of 1" to allow for face mount moulding application. Overlay Fillers are available in MFO heights to align with doors, see pages 509-512 for OL..MFO and OL..MFOP. Not compatible with Add Toekick modification. When Authentic End(s) are ordered in conjunction with Modified Full Overlay, the Authentic End will match the face frame reveal. Not available on Aluminum Frame Doors. Not available on Herra, Prestley, MDF door styles, and partial overlay styles. Not available on Galena mullion doors.	No Upcharge
<b>Scooped Drawer (SCPDRW) (SCPDRWB) (SCPDRWL) (SCPDRWR)</b>	Most base cabinets	Replaces top drawer box with a 2" high drawer box to allow for clearance of cooktops, etc. Only top drawer will be modified when specified on drawer bases. On base cabinets with two top drawers, L, R, or B must be specified. Increases clearance for cooktops from 2 1/2" to 3 7/8". When SCPDRW is selected on 2DB18-2DB42, top drawer will utilize a 6 3/8" high drawer box, creating a clearance of 6 5/8" for the cooktop. Not available on MDF or Herra door styles.	SCPDRW: Cabinet list + \$68 SCPDRWB: Cabinet list + \$136 SCPDRWL: Cabinet list + \$68 SCPDRWR: Cabinet list + \$68

## DOOR PANEL - SOLID REVERSE RAISED (DPSRR)

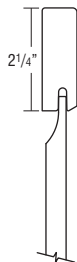

## MODIFIED FULL OVERLAY (MFO)

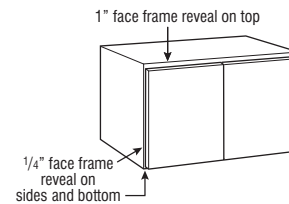

## SCOOPED DRAWER (SCPDRW/SCPDRWB/SCPDRWL/SCPDRWR)

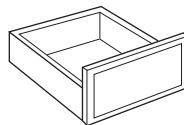

# END PANEL MODIFICATIONS

See page 40 for modification compatibility. Each modification will be priced accordingly. Requests for non-published modifications may be treated as a Special Sales Order which will require feasibility, pricing and leadtime review and approval. Please check with your customer service representative before placing your order.

OPTION NAME	APPLICABLE CABINET GROUP	DESCRIPTION/LIMITATIONS	PRICING
<b>Authentic Ends (AETHL) (AETHR)</b>	Most wall, base, tall, and vanity cabinets	<p>Modifies cabinet end panel(s) with applied decorative door(s) onto FPEB upgraded end panel(s). Includes FPEB modification — If AETHL or AETHR upgrades are specified, the opposite end panel is also FPEB.</p> <p>Available on most cabinets with depths of 9", 12", 15", 18", 21", 24" and 27". Custom doors must be specified for other depths not listed. 9" depth available on cabinets 30" high or taller.</p> <p>12" and 15" high wall cabinets will have double door configuration on 21" and 24" deep applications.</p> <p>For tall cabinets, non-miter doors have two panels on the bottom door.</p> <p>Decorative door for wall and tall cabinets will match style chosen on order, i.e., arch or square.</p> <p>27" deep cabinets and Floating Island Cabinets (FIC_ , FICNT_ ) will have double door configuration. Office base cabinets (29" high) will have double door configuration when specified on 24" deep cabinets.</p>	<p>Wall: \$390 list per side                      Base &amp; Vanity: \$553 list per side                      Tall: \$1,321 list per side</p>
<b>Face Frame and Door on End (FFDL) (FFDR)</b>	Most wall, base, tall, and vanity cabinets	<p>Creates a working door on the end of the specified cabinet. Opposite end panel will be FPEB. Side cabinet configuration will match front configuration.</p> <p>On Base and Tall cabinets, recessed toe space is standard on the side specified with FFDR or FFDL (if any flush toekick modification is specified, FFD side of cabinet will also be flush). 12" deep cabinets specified with FFDL or FFDR and FTKAV or FTKFV will receive a standard flush toekick.</p> <p>Full depth shelves standard. Glass shelves not compatible with the FFD modification.</p> <p>Doors will always be hinged on the back of the cabinet. Option not available on both ends of cabinet. Not available on peninsula cabinets. Available on cabinets in depths of 12", 15", 18", 21", and 24".</p> <p>If glass is specified, the FFD door will also be glass. When ordered with MD on 12" deep cabinets, the FFD door will be Cut-for-glass. When ordered with Mullion Doors on 39" or 42" high cabinets, adjustable shelves will not align with mullions.</p>	<p>Wall: \$390 list                      Base &amp; Vanity: \$553 list                      Tall: \$1,321 list</p>
<b>Finished Ends (FB)</b>	Cabinets with PE or APC modification; both ends will be finished	Creates a matching finished 1/2" veneer plywood exterior.	<p>Wall: \$78 list                      Base: \$127 list                      Tall: \$321 list</p>
<b>Furniture Finished Plywood* Ends (FPEB)</b>	Most wall, base, tall, office, and vanity cabinets	Replaces standard cabinet ends with 3/4" finished veneer end panels to achieve a Furniture End appearance. Both exterior sides are finished. Includes PE upgrade and standard laminate interior. Order APC for clear coated veneer interior. Matching Interior Plywood (MIP) is available.	<p>Wall: \$157 list                      Base &amp; Vanity: \$227 list                      Tall: \$406 list</p>

## AUTHENTIC ENDS (AETHL/AETHR)

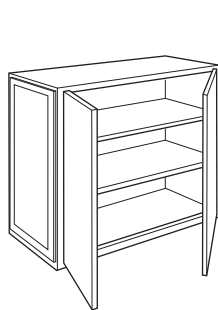

Wall cabinets

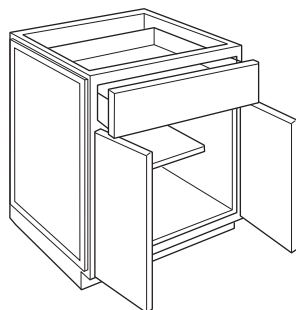

Base and Vanity cabinets

## FURNITURE FINISHED PLYWOOD ENDS (FPEB)

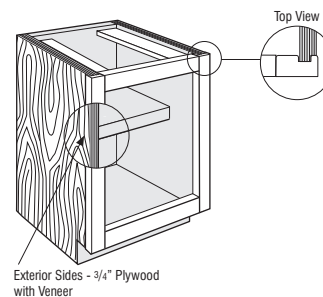

Exterior Sides - 3/4" Plywood with Veneer

## FACE FRAME AND DOOR ON END (FFDL/FFDR)

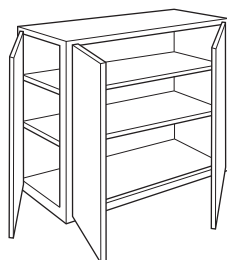

Wall cabinets

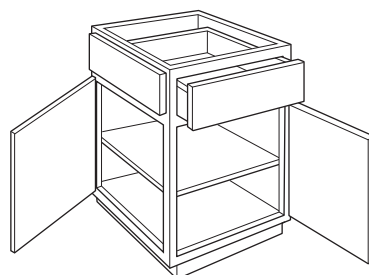

Base cabinets

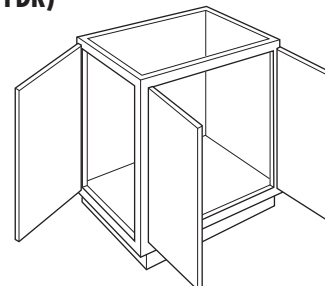

Vanity cabinets



\*All-plywood components meet ANSI/HPVA HP-1 standards and may contain MDF or particleboard.

# FINISH MODIFICATIONS

See page 40 for modification compatibility. Each modification will be priced accordingly. Requests for non-published modifications may be treated as a Special Sales Order which will require feasibility, pricing and leadtime review and approval. Please check with your customer service representative before placing your order.

OPTION NAME	APPLICABLE CABINET GROUP	DESCRIPTION/LIMITATIONS	PRICING
<b>Matching Interior Plywood (MIP)</b>	Most cabinets	Modifies the cabinet interior and end panel exterior to matching finished veneer plywood. Cabinet top and bottom exterior on wall and tall cabinets is also matching finished veneer plywood.  Cabinet construction features 1/2" plywood ends and 3/8" top, bottom, and back. Shelves are upgraded to full depth 3/4" veneered plywood.  Interior wood accessories feature a natural finish and will not match cabinet exterior.  When a decorative door option is chosen in 20/20, Matching Interior Plywood (MIP) is a preselected option. If MIP is not desired, it can be deselected by choosing NOTMIP.	Cabinet list + 25%
	Most end panels with fillers attached	Replaces standard panel material with veneer plywood finished on both sides.	List + 25%
<b>White Laminate Interior (WLI)</b>	White cabinets with APC	Replaces clear coated veneer plywood interior with White laminate plywood interior. Wall cabinet exterior tops and bottoms will be white laminate. PFINBTMB is recommended for use when WLI cabinets are adjacent to cabinets with natural maple laminate or clear coated veneer cabinet bottoms. Finished Ends (FB) is recommended for matching finished veneer ends.  Only available on cabinets in White (painted Maple or Laminate) that are specified with APC.  WLI shelves are plywood with White laminate, interior accessories will not change.	No Upcharge

## MATCHING INTERIOR PLYWOOD (MIP)

-  matching finished veneer
-  standard matching finished component
-  standard non-matching finished component

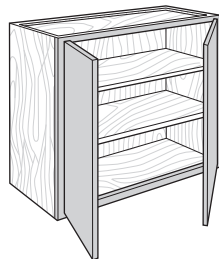

Wall cabinets

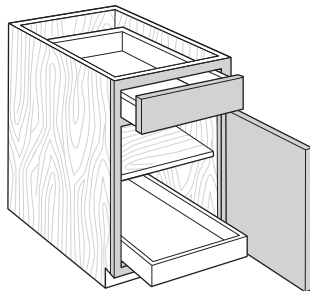

Base cabinets

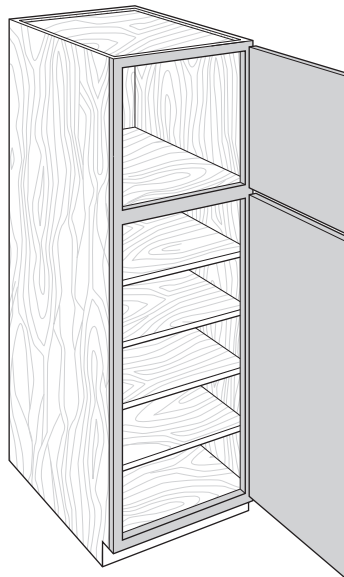

Tall cabinets

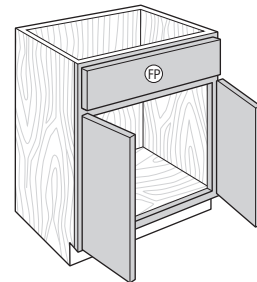

Vanity cabinets

## WHITE LAMINATE INTERIOR (WLI)

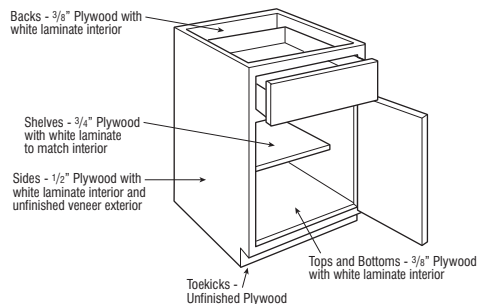

# BOX MODIFICATIONS

See page 40 for modification compatibility. Each modification will be priced accordingly. Requests for non-published modifications may be treated as a Special Sales Order which will require feasibility, pricing and leadtime review and approval. Please check with your customer service representative before placing your order.

OPTION NAME	APPLICABLE CABINET GROUP	DESCRIPTION/LIMITATIONS	PRICING
<b>Cabinet Box Only (CBO)</b>	Most wall, base, tall, and vanity cabinets	Removes doors, drawer fronts, and any accessory items attached to a door or drawer front. Drawer box and any interior components attached to the cabinet box will be included. Frames will not be drilled for hinges.	Wall & Tall: 85% of cabinet list Base & Vanity: 90% of cabinet list
<b>Cabinet Case Only (CCO)</b>	Most wall, base, tall, and vanity cabinets	Removes doors, drawer fronts, drawer boxes, interior components, and mini touch-up kits. Frames will not be drilled for hinges, but cabinet will have standard drilling for shelves and guides.	85% of cabinet list
<b>Cabinet False Panel (CFP)</b>	Most base and vanity cabinets with a top drawer	Replaces top drawer with false panel. Not available with deep drawers.	No Upcharge
<b>Cabinet with No Door, with Drawer (CND)</b>	Most wall, base, tall, and vanity cabinets with door(s) and drawer(s)	Removes door(s). Complete drawer(s) with drawer front(s) and interior components remain in cabinet. Frames will not be drilled for hinges.	90% of cabinet list

## CABINET BOX ONLY (CBO)

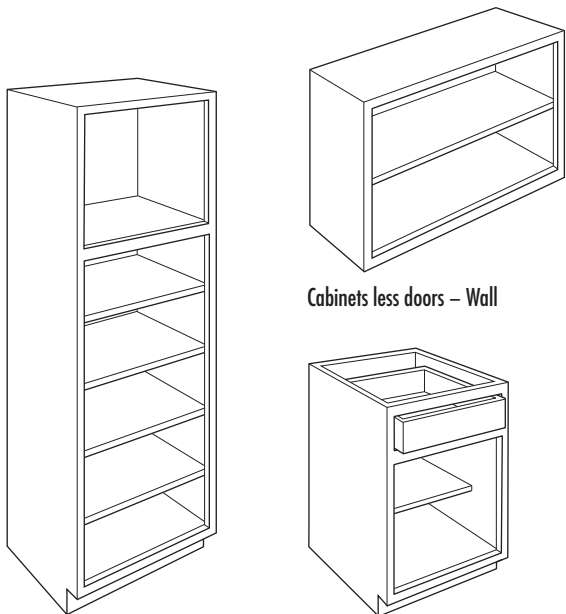

Cabinets less doors – Tall

Cabinets less doors – Wall

Cabinets less doors and drawer fronts – Base

## CABINET CASE ONLY (CCO)

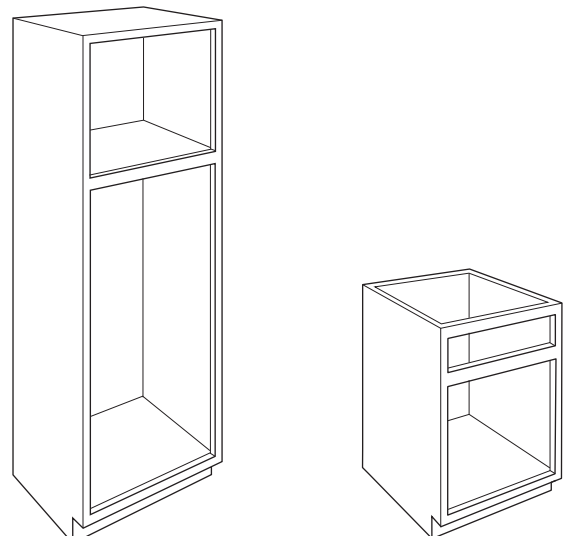

Cabinet case only – Tall

Cabinet case only – Base

## CABINET FALSE PANEL (CFP)

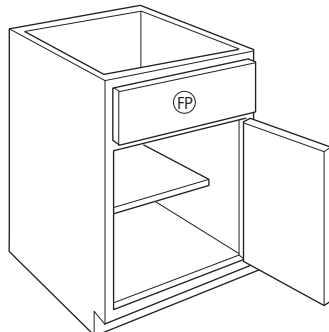

Base and Vanity cabinets

## CABINET WITH NO DOOR, WITH DRAWER (CND)

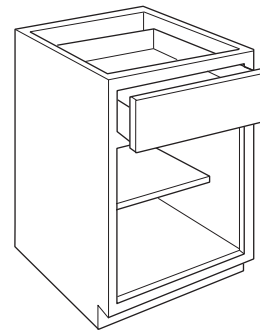

Base and Vanity cabinets

## BOX MODIFICATIONS (cont'd)

See page 40 for modification compatibility. Each modification will be priced accordingly. Requests for non-published modifications may be treated as a Special Sales Order which will require feasibility, pricing and leadtime review and approval. Please check with your customer service representative before placing your order.

OPTION NAME	APPLICABLE CABINET GROUP	DESCRIPTION/LIMITATIONS	PRICING
<b>Increased Depth (ID)</b>	Most wall and vanity cabinets	Increases the depth of wall and vanity cabinets in 1" increments to a maximum depth of 24". Increased depth wall cabinets should be either floor mounted or stacked to maintain stability. Any specified shelving is included and is always full depth. Wall peninsula cabinets may be increased in 1" increments to 18" maximum. Depth restrictions may apply where depths are available as a standard cabinet. Wall cabinets 12" deep are limited to up to 15" deep on sizes where a 24" deep cabinet is available.	No Upcharge
	Most base, tall, and vanity cabinets without drawers or roll trays	Increases the depth of base, tall, and vanity cabinets without drawers or roll trays in 1" increments to 27". When depth beyond 24" is desired on tall cabinets, the 24" deep cabinet must be modified. Any specified shelving is included and is always full depth. Depth restrictions may apply where depths are available as a standard cabinet.	No Upcharge
	Oven Cabinets	Increases the depth of oven cabinets in 1" increments to a maximum depth of 27". When oven cabinets with drawers are increased, drawer depth will not change. Any specified shelving is included and is always full depth.	No Upcharge
	End panels	Increases the depth of end panels in 1" increments to a maximum depth of 36". 31"-36" depths available on plywood panels only. AEL/AER panels are only available in 3" increments up to a maximum depth of 36".	No Upcharge
<b>Reduced Depth (RD)</b>	Most base, tall, and vanity cabinets with drawers or roll trays	Reduces the depth in 1" increments to a minimum depth of 12". Any specified shelving is included and is always full depth. The dimension is specified as the distance from the front of the face frame to the back of the cabinet.	No Upcharge
	Most base, tall, and vanity cabinets without drawers or roll trays	Reduces the depth in 1" increments to a minimum depth of 6". If reduced depth to 8" or less, toekick will not be included. Any specified shelving is included and is always full depth. The dimension is specified as the distance from the front of the face frame to the back of the cabinet.	No Upcharge
	Most wall cabinets	Reduces the depth in 1" increments to a minimum depth of 6". Any specified shelving is included and is always full depth. The dimension is specified as the distance from the front of the face frame to the back of the cabinet. Wall top hinge cabinets can only be reduced to 9" depth minimum.	No Upcharge
	End panels	Reduces the depth in 1" increments to a minimum depth of 6".	No Upcharge
	Roll tray kits	Reduces the depth in 1" increments to fit a minimum cabinet depth of 12".	No Upcharge

Cabinet Depth	Drawer Box and Roll Tray Exterior Depth		Clearance Behind Drawer Box or Roll Tray and Back Panel	
	Standard Drawer Guides	Heavy Duty Side-mount Guides (DDFD)	Standard Drawer Guides	Heavy Duty Side-mount Guides (DDFD)
24	21	21	2 3/4	2 3/4
23	21	18	1 3/4	4 3/4
22	18	18	3 3/4	3 3/4
21	18	18	2 3/4	2 3/4
20	18	N/A	1 3/4	N/A
19	15	N/A	3 3/4	N/A
18	15	N/A	2 3/4	N/A
17	15	N/A	1 3/4	N/A
16	12	N/A	3 3/4	N/A
15	12	N/A	2 3/4	N/A
14	12	N/A	1 3/4	N/A
13	9	N/A	3 3/4	N/A
12	9	N/A	2 3/4	N/A

### INCREASED DEPTH (ID)

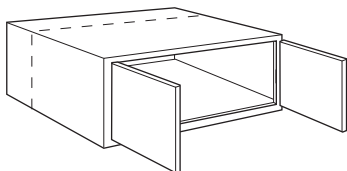

Wall cabinets

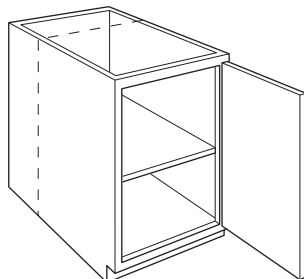

Base cabinets

### REDUCED DEPTH (RD)

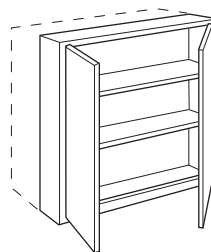

Wall cabinets

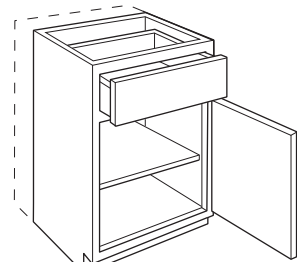

Base cabinets

## BOX MODIFICATIONS (cont'd)

See page 40 for modification compatibility. Each modification will be priced accordingly. Requests for non-published modifications may be treated as a Special Sales Order which will require feasibility, pricing and leadtime review and approval. Please check with your customer service representative before placing your order.

OPTION NAME	APPLICABLE CABINET GROUP	DESCRIPTION/LIMITATIONS	PRICING
<b>End Extended Back (EXBKL) (EXBKR)</b>	Most cabinets	<p>Extends cabinet end panel back in 1" increments, available up to 6" per side. Includes FPEB modification with 3/4" finished veneer end panels on both ends.</p> <p>EXBKL and EXBKR are compatible with each other and can be specified with either the same dimension per side or unique dimensions if desired. Compatible with Authentic Ends when End Extended Back is specified in 3" increments.</p>	<p>Wall: Cabinet list + \$169                      Base: Cabinet list + \$238                      Tall: Cabinet list + \$426</p>
<b>Prepare Cabinet for Finished Bottom (PFINBTMB)</b>	Most wall cabinets	<p>Prepares cabinet for installation of a separately purchased and field installed applied 1/4" end panel skin to create a flush finished bottom on a single cabinet or multiple cabinets that are bridged between taller adjacent cabinets.</p> <p>Features factory installed spacer blocks against the cabinet bottom, along the face frame, back, and end panels. Cabinet back and end panel heights are 1/4" less than the face frame, leaving clearance for the applied skin. Cabinet end panel bottom edge remains unfinished.</p> <p>Panel utilized for flush bottom must be purchased separately using 1/4" end panel skins (see WEPS__, TEPS__, or BEPS__ on pages 519-520) or 1/4" custom panels (see DAPNLT/4 on page 534), and requires cabinet installer to cut to size before installation.</p> <p>If used on the end of a run, moulding or a full height end panel skin must be purchased separately to cover exposed unfinished edge of applied skin for the flush finished bottom. Not compatible with FPEB, AUTHL/AUTHR, FFDL/FFDR, and EXBKL/EXBKR modifications.</p>	Cabinet list + \$157

**END EXTENDED BACK LEFT (EXBKL)**

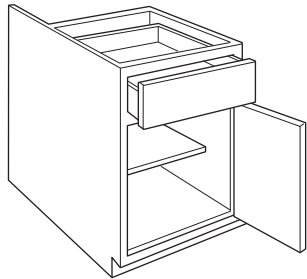

**END EXTENDED BACK RIGHT (EXBKR)**

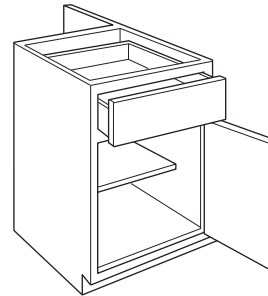

**PREPARE CABINET FOR FINISHED BOTTOM (PFINBTMB)**

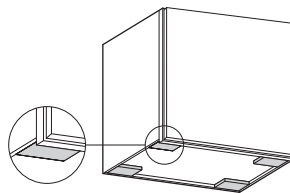

# FACE FRAME MODIFICATIONS

See page 40 for modification compatibility. Each modification will be priced accordingly. Requests for non-published modifications may be treated as a Special Sales Order which will require feasibility, pricing and leadtime review and approval. Please check with your customer service representative before placing your order.

OPTION NAME	APPLICABLE CABINET GROUP	DESCRIPTION/LIMITATIONS	PRICING
<b>Appliance Cut-out, Single (ACS)</b>	Most Oven Cabinets	Creates a custom cut-out area for field-ready oven installation. Custom Width dimension available in 1/4" increments, with a minimum of 1/2" to a maximum of 6" less than the cabinet width. Frame side stiles will not be notched. Custom Height dimension available in 1/4" increments. <ul style="list-style-type: none"> <li>• Cut-out area will be centered.</li> <li>• Available on oven cabinets specified with an (N) for Narrow Stile, with 1 1/2" wide frame side stiles. See cabinet specifications for available cut-out dimensions.</li> </ul>	Cabinet list + \$123
<b>Extended Stile (EXL) (EXR)</b>	Most cabinets with a face frame	Extends face frame width beyond its normal width by specified dimension to eliminate the need for field installed fillers, available in 1/2" increments from 1/2"-3". For example, a 1 1/2" wide face frame with EXL2 will have a width of 3 1/2" on the left side of the cabinet. Extended Left: EXL.5, EXL1, EXL1.5, EXL2, EXL2.5, EXL3 Extended Right: EXR.5, EXR1, EXR1.5, EXR2, EXR2.5, EXR3  EXL and EXR are compatible with each other and can be specified with either the same dimension per side or unique dimensions if desired. When ordered with Peninsula (P) modification, both face frames on specified side will be modified.	No Upcharge

## APPLIANCE CUT-OUT, SINGLE (ACS)

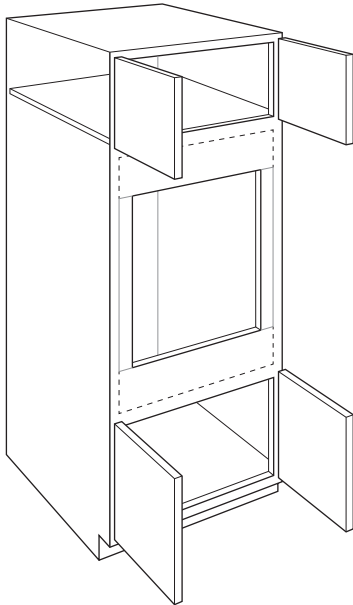

## EXTENDED STILE LEFT (EXL)

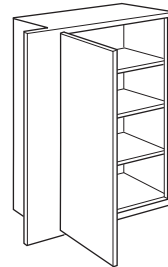

Cabinets with a face frame – Wall

## EXTENDED STILE RIGHT (EXR)

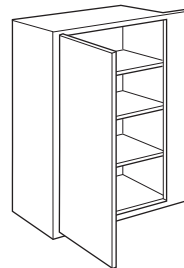

Cabinets with a face frame – Wall



## FACE FRAME MODIFICATIONS (cont'd)

See page 40 for modification compatibility. Each modification will be priced accordingly. Requests for non-published modifications may be treated as a Special Sales Order which will require feasibility, pricing and leadtime review and approval. Please check with your customer service representative before placing your order.

OPTION NAME	APPLICABLE CABINET GROUP	DESCRIPTION/LIMITATIONS	PRICING
<b>Inverted Frame (INVFRM)</b>	Most cabinets with a face frame cross rail  Tall Panels with Filler Attached and Authentic Ends	Inverts face frame openings. Drawer openings relocated to the bottom of a base cabinet must always be a working drawer. Opening sizes for doors do not change, standard drawer opening changes to 4 1/2" high.  On tall and stacked walls, when INVFRM is ordered in conjunction with CG (Cut-for-glass), top and bottom locations should be specified after the frame is inverted. Glass only available on doors for 41 1/2" high or less.  Doors on inverted frame cabinets may not align with adjacent cabinet doors.  On Tall Panels with Filler Attached and Authentic Ends, when INVFRM is selected, doors will be inverted (no face frame) to align with tall cabinets with the modification.	No Upcharge
<b>Valance Top Rail (TVRAV) (TVRFV) (TVRVV)</b>	Base Open Cabinets, Bookcases, Wall Open Cabinets	Modifies the top rail with an arch, furniture, or straight valance.	No Upcharge

### INVERTED FRAME (INVFRM)

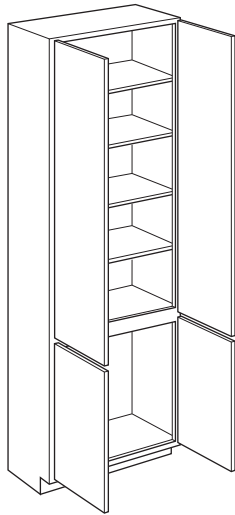

Tall cabinets

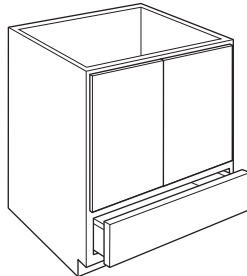

Base cabinets

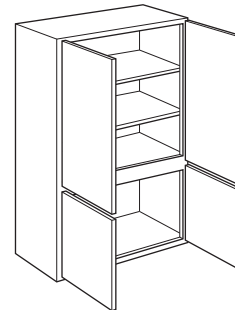

Wall cabinets

#### VALANCE TOP RAIL, ARCH (TVRAV)

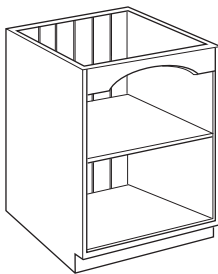

#### VALANCE TOP RAIL, FURNITURE (TVRFV)

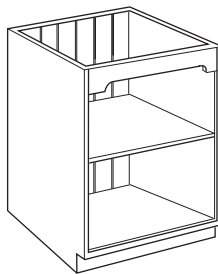

#### VALANCE TOP RAIL, STRAIGHT (TVRVV)

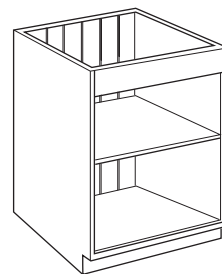

# INSTALLED INTERIOR MODIFICATIONS

See page 40 for modification compatibility. Each modification will be priced accordingly. Requests for non-published modifications may be treated as a Special Sales Order which will require feasibility, pricing and leadtime review and approval. Please check with your customer service representative before placing your order.

OPTION NAME	APPLICABLE CABINET GROUP	DESCRIPTION/LIMITATIONS	PRICING
<b>Secured Drawer featuring Master Lock Biometric Technology (DRWSEC) (DRWSECB) (DRWSECL) (DRWSECR)</b>	Most base cabinets with a top drawer	<p>Modifies the standard drawer box with an installed self-locking mechanism featuring proven Master Lock advanced sensor biometric technology. When activated, drawer opens 2 3/16" to access fingerprint reader, which stores up to 100 unique fingerprints. Homeowner must reset memory after cabinet installation. Secured housing protrudes 2 3/4" into the depth of the drawer box interior.</p> <p>Features one 9V battery compartment (battery not included). Self-locking when in closed position. Manual key lock on bottom of drawer for backup method of entry.</p> <p>DRWSEC available on 24" deep base cabinets with widths of 18", 21", and 24".</p> <p>DRWSECL, DRWSECR, and DRWSECB available on 24" deep base cabinets with widths of 42" and 48".</p> <p>Not compatible with Reduced Depth (RD) modification or PowerGlide™ Compact Drawer Outlet (DRWPWR).</p> <p>Installer must remove the drawer front to drill and countersink the back of the drawer front for field installation of knobs and pulls.</p>	<p>DRWSEC: Cabinet list + \$590</p> <p>DRWSECB: Cabinet list + \$1,180</p> <p>DRWSECL: Cabinet list + \$590</p> <p>DRWSECR: Cabinet list + \$590</p>
<b>CabMat™ (CMAT1) (CMAT2)</b>	Most sink base and vanity cabinets	<p>Installs removable CabMat™, size is determined by face frame opening width and cabinet depth.</p> <p>CMAT2 is only available on vanity cabinets designed for double bowl applications.</p> <p>Not available with Reduced Depth modification. When ordered with Increased Depth modification, CabMat™ size does not change.</p> <p>Vanity cabinets with face frame openings of 24" and 30" will utilize CabMat™ sized for 21" and 27" openings.</p> <p>See page 579 for CabMat™ product descriptions.</p>	<p>CMAT1: Cabinet list + \$284</p> <p>CMAT2: Cabinet list + \$568</p>
<b>Full Depth Shelf (FD)</b>	Base cabinets with standard half depth shelves	Replaces standard shelf with full depth shelf.	Cabinet list + \$59

## SECURED DRAWER FEATURING MASTER LOCK BIOMETRIC TECHNOLOGY (DRWSEC/DRWSECB/DRWSECL/DRWSECR)

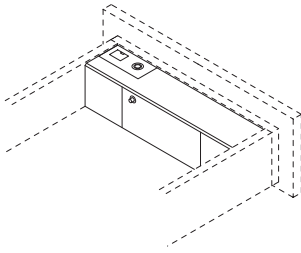

## FULL DEPTH SHELF (FD)

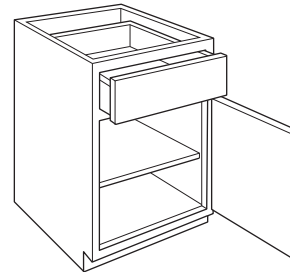

## CABMAT™ (CMAT1/CMAT2)

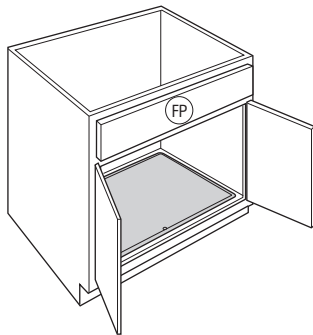

Base cabinets (CMAT1)

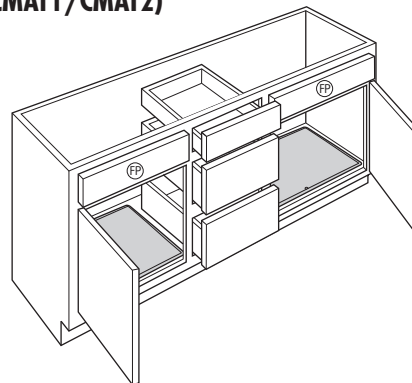

Vanity cabinets with double bowl (CMAT2)

## INSTALLED INTERIOR MODIFICATIONS (cont'd)

See page 40 for modification compatibility. Each modification will be priced accordingly. Requests for non-published modifications may be treated as a Special Sales Order which will require feasibility, pricing and leadtime review and approval. Please check with your customer service representative before placing your order.

OPTION NAME	APPLICABLE CABINET GROUP	DESCRIPTION/LIMITATIONS	PRICING
<b>Deep Roll Tray (DRT)</b>	Most cabinets with roll trays	Replaces standard roll trays with a 6 3/8" high deep roll tray. Replaces bottom roll tray only on base cabinets and bottom 2 roll trays on utility cabinets.	Base: Cabinet list + \$102 Tall: Cabinet list + \$204
<b>EasyTrax™ (ET)</b>	Most cabinets with roll trays	Includes pre-installed upright wooden system that allows for easy height adjustment of roll trays.	Base: Cabinet list + \$209 Tall: Cabinet list + \$367
<b>Installed Roll Tray (RT)</b>	Select base, tall, office, and vanity cabinets	<p>Installs specified number of roll trays (1-5 per side). Example, for two roll trays, specify 2RT.</p> <p>On cabinets with center stile, specify RTL for roll trays in left side and RTR for roll trays in right side. RTL and RTR should be selected for roll trays in both sides.</p> <p>When 1RT is specified on a base cabinet, the roll tray is installed in the lowest position and one half depth adjustable shelf is included. On utility cabinets for lower section, 1RT includes three shelves, 2RT includes two shelves, and 3RT includes 1 shelf. No shelves for lower section are included with 4RT or 5RT.</p>	1RT: Cabinet list + \$284 2RT: Cabinet list + \$568 3RT: Cabinet list + \$852 4RT: Cabinet list + \$1,136 5RT: Cabinet list + \$1,420
<b>Light Installed Battery Strip (LTI.BS) (LTI.BSB) (LTI.BSL) (LTI.BSR)</b>	Select base, office, and vanity cabinets	<p>Installs a battery operated LED light inside the cabinet door opening(s).</p> <p>LTI.BS installs one LED light inside the cabinet door opening.</p> <p>LTI.BSB installs two LED lights inside both left and right cabinet door openings. On corner cabinets, installs one LED light for the top section and one LED light below fixed shelf for bottom section.</p> <p>LTI.BSL installs one LED light in the left door opening.</p> <p>LTI.BSR installs one LED light in the right door opening.</p> <p>Battery operated - (4) AAA batteries (not included). Motion activated. Low power usage (0.3W). Plastic aluminum finish. Dimensions: Length 11.93" (303mm), Width 0.67" (17mm), and Depth 0.55" (14mm).</p>	LTI.BS: Cabinet list + \$155 LTI.BSB: Cabinet list + \$310 LTI.BSL: Cabinet list + \$155 LTI.BSR: Cabinet list + \$155

### DEEP ROLL TRAY (DRT)

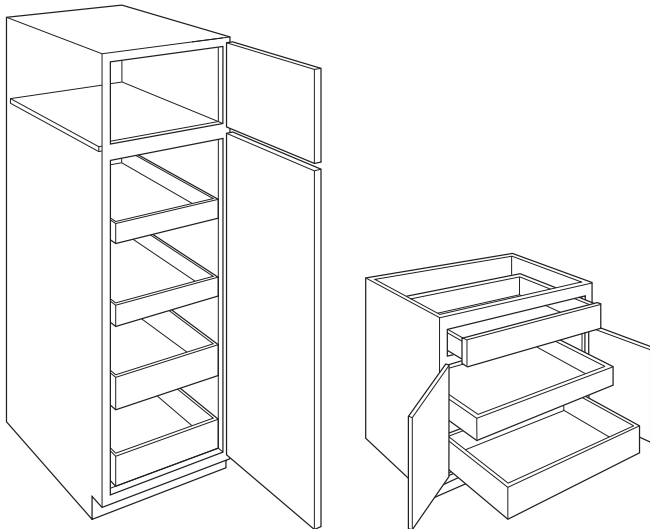

Tall cabinets

Base cabinets

### INSTALLED ROLL TRAY (RT)

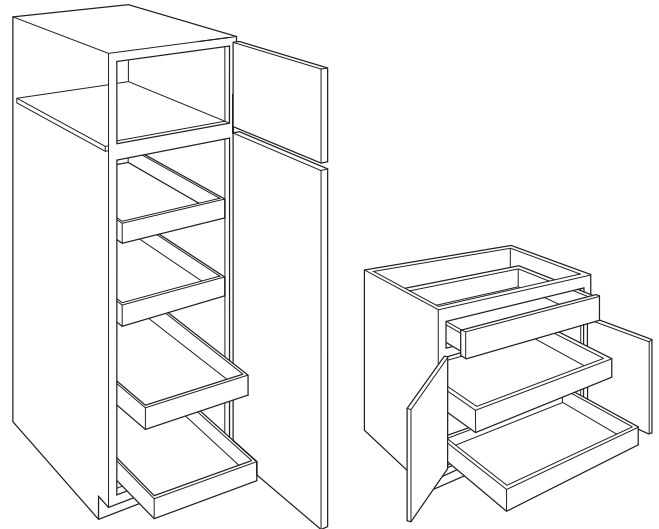

Tall cabinets

Base, Office, and Vanity cabinets

### LIGHT INSTALLED BATTERY STRIP (LTI.BS/LTI.BSB/LTI.BSL/LTI.BSR)

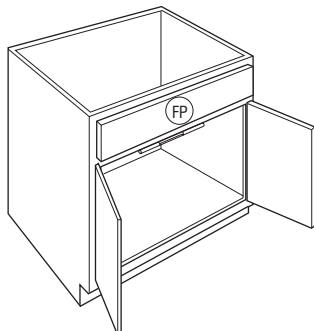

Base cabinet (LTI.BS)

### EASYTRAX™ (ET)

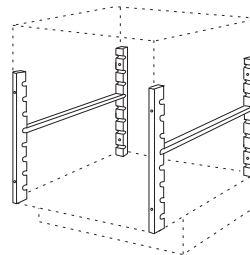

## INSTALLED INTERIOR MODIFICATIONS (cont'd)

See page 40 for modification compatibility. Each modification will be priced accordingly. Requests for non-published modifications may be treated as a Special Sales Order which will require feasibility, pricing and leadtime review and approval. Please check with your customer service representative before placing your order.

OPTION NAME	APPLICABLE CABINET GROUP	DESCRIPTION/LIMITATIONS	PRICING
<b>PowerGlide™ Compact Drawer Outlet (DRWPWR) (DRWPWRB) (DRWPWRL) (DRWPWRR)</b>	Most base cabinets with a top drawer	Installs PowerGlide™ Compact Drawer Outlet into the drawer box. Includes two 120V electrical plug-ins and two 2.1 amp rated USB charging ports with a total rated capacity of 15 amps. Cord has 3 ft. of length hanging freely from back mounting bracket. The cord is 14 gauge wire and features a standard 3-prong plug and is required to be plugged into an approved GFCI outlet for all applications. Outlet is ETL approved-compliant for electrical and other safety standards to U.S. and Canadian safety including UL standards. Outlet face plate measures 5.22" x 2.3" and will extend 3/4" into drawer box. Available on base cabinet widths of 18"-36". For use in cabinet depths of 15", 18", 21", and 24". Only compatible with RD in 3" increments. Also available as a field installed accessory, see DRWPWR1 on page 582.	DRWPWR: Cabinet list + \$480 DRWPWRB: Cabinet list + \$960 DRWPWRL: Cabinet list + \$480 DRWPWRR: Cabinet list + \$480
<b>Push to Open Wastebasket (PTOWB)</b>	Base cabinets with door mounted wastebasket pull-outs	Changes the guide mechanism on wastebasket pull-outs to a mechanical push to open guide with Smart Stop. Available on 24" deep cabinets only. Does not change other drawer guides on the cabinet.	Cabinet list + \$421
<b>Tilt-out Tray, Stainless Steel Slim (TOTSSS)</b>	Cabinets with false panels	Installs one stainless steel tilt-out tray inside of each false panel. Tray is 1 11/16" deep and protrudes 3/4" into cabinet.	Cabinet list + \$273

### POWERGLIDE™ COMPACT DRAWER OUTLET (DRWPWR/DRWPWRB/DRWPWRL/DRWPWRR)

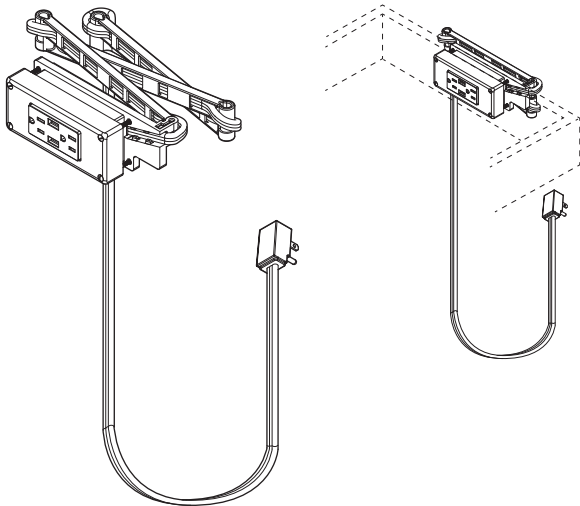

### TILT-OUT TRAY, STAINLESS STEEL SLIM (TOTSSS)

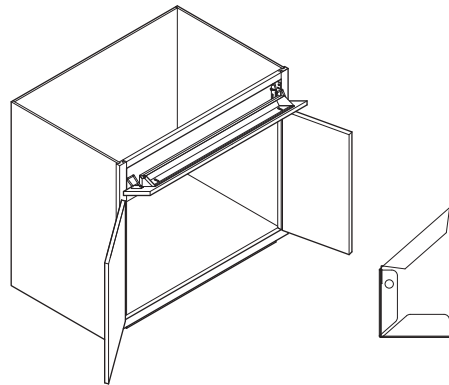

### PUSH TO OPEN WASTEBASKET (PTOWB)

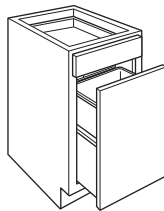

## INSTALLED INTERIOR MODIFICATIONS (cont'd)

See page 40 for modification compatibility. Each modification will be priced accordingly. Requests for non-published modifications may be treated as a Special Sales Order which will require feasibility, pricing and leadtime review and approval. Please check with your customer service representative before placing your order.

OPTION NAME	APPLICABLE CABINET GROUP	DESCRIPTION/LIMITATIONS	PRICING																		
<b>Tray Dividers (TD)</b>	Most wall, full height base, and tall cabinets	<p>Installs removable Tray Dividers. Plywood dividers match the interior of the cabinet. Rails for dividers are Natural Maple regardless of the color of the interior of the cabinet.</p> <p>Number of dividers is predetermined based on cabinet width. See chart below.</p> <p>Available only in the top of Stacked Walls and Tall Cabinets.</p> <p>Available with Reduced Depth modification (12" minimum) and Increased Depth modification (27" maximum). When cabinet is increased to 27", tray dividers will be 24" deep set back 3" into the cabinet.</p> <p>Base Full Height cabinets will have a top. Not available with Peninsula modification.</p> <p>Available on cabinets with frame height openings of 15"-27" with full top and bottom panels.</p> <table border="1" style="margin: 10px auto; border-collapse: collapse; text-align: center;"> <thead> <tr> <th>Cabinet Width</th> <th># of Dividers</th> <th>Mod Name</th> </tr> </thead> <tbody> <tr> <td>9"-12"</td> <td>1</td> <td>1TD</td> </tr> <tr> <td>15"-18"</td> <td>2</td> <td>2TD</td> </tr> <tr> <td>21"-24"</td> <td>3</td> <td>3TD</td> </tr> <tr> <td>27"-30"</td> <td>4</td> <td>4TD</td> </tr> <tr> <td>33"-37"</td> <td>5</td> <td>5TD</td> </tr> </tbody> </table>	Cabinet Width	# of Dividers	Mod Name	9"-12"	1	1TD	15"-18"	2	2TD	21"-24"	3	3TD	27"-30"	4	4TD	33"-37"	5	5TD	<p>1TD: Cabinet list + \$186                      2TD: Cabinet list + \$372                      3TD: Cabinet list + \$558                      4TD: Cabinet list + \$744                      5TD: Cabinet list + \$930</p>
Cabinet Width	# of Dividers	Mod Name																			
9"-12"	1	1TD																			
15"-18"	2	2TD																			
21"-24"	3	3TD																			
27"-30"	4	4TD																			
33"-37"	5	5TD																			

### TRAY DIVIDERS (TD)

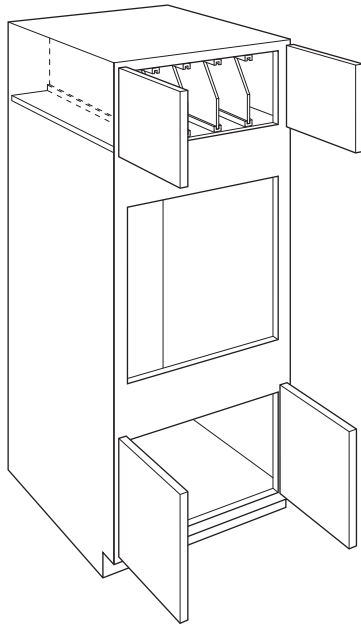

Tall cabinets

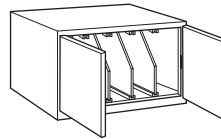

Wall cabinets

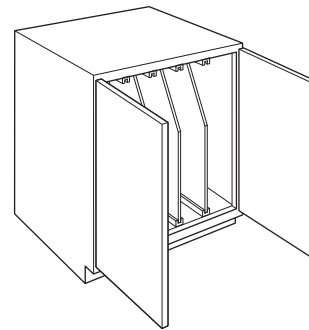

Base cabinets

# TOEKICK MODIFICATIONS

See page 40 for modification compatibility. Each modification will be priced accordingly. Requests for non-published modifications may be treated as a Special Sales Order which will require feasibility, pricing and leadtime review and approval. Please check with your customer service representative before placing your order.

OPTION NAME	APPLICABLE CABINET GROUP	DESCRIPTION/LIMITATIONS	PRICING
<b>Add Toekick (ADDTK)</b>	Most wall cabinets	<p>Creates a 4 1/2" toekick on the front of cabinet. Cabinet top changes to use I-beam construction when ADDTK is selected. ADDTK with reduced depth is available on cabinets 9" deep or larger.</p> <p>Peninsula cabinets are available with ADDTK 15" deep and larger. Depths of 14" and less will not have ADDTK available.</p> <p>Furniture drawers will be available with ADDTK option down to a reduced depth of 12".</p> <p>All cabinets will feature square doors to match cabinets on order. If arch door style is ordered, 20/20 layout will show arch doors, however, square doors will be sent.</p> <p>Available with compatible toekick modifications. See the Modification/Upgrade Compatibility Chart on page 40 for details.</p>	No Upcharge
<b>Flush Toekick (FTK) (FTK.FNT.P) (FTK.P)</b>	Most base, tall, and vanity cabinets, and wall cabinets with ADDTK	<p>Extends the face frame to the floor eliminating the toe space. Not available when either RECTKL or RECTKR modifications are used. Not available on 93" or 96" tall cabinets due to separate pedestal base toekick.</p> <p>When FTK is ordered with the Peninsula modification, only the working drawer side will receive a flush toekick.</p> <p>When FTK.FNT.P is ordered with the Peninsula modification, both sides will receive a flush toekick.</p> <p>When FTK.P is ordered with the Peninsula modification, only the peninsula side will receive a flush toekick.</p>	No Upcharge

### ADD TOEKICK (ADDTK)

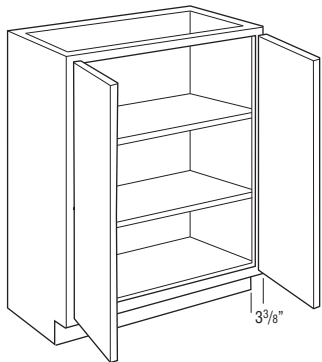

Wall cabinets

### FLUSH TOEKICK (FTK)

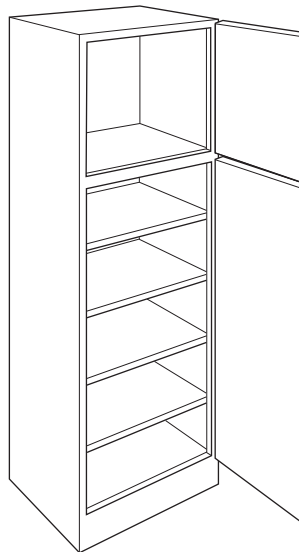

Tall cabinets

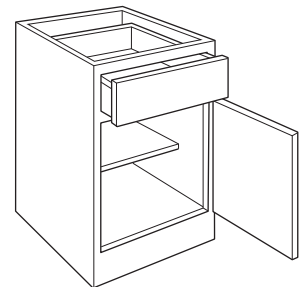

Base cabinets

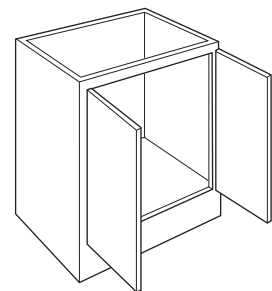

Vanity cabinets

### FLUSH TOEKICK FRONT & PENINSULA (FTK.FNT.P)

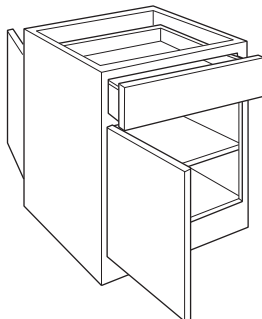

Base cabinets

### FLUSH TOEKICK PENINSULA (FTK.P)

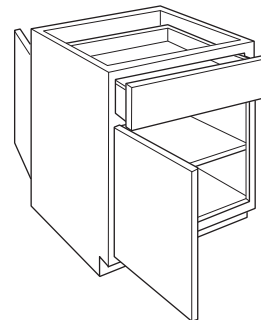

Base cabinets

## TOEKICK MODIFICATIONS (cont'd)

See page 40 for modification compatibility. Each modification will be priced accordingly. Requests for non-published modifications may be treated as a Special Sales Order which will require feasibility, pricing and leadtime review and approval. Please check with your customer service representative before placing your order.

OPTION NAME	APPLICABLE CABINET GROUP	DESCRIPTION/LIMITATIONS	PRICING
<b>Flush Toekick Arch (FTKAV) (FTKAV.P) (FTKAV.FNT.P)</b>	Most base, tall, and vanity cabinets, and wall cabinets with ADDTK	Creates an arch flush toe space. Valance replaces standard toekick creating a full open area beneath cabinet floor.  When FTKAV.FNT.P is ordered with the Peninsula modification, both sides will receive an arch flush toekick.  When FTKAV.P is ordered with the Peninsula modification, only the peninsula side will receive an arch flush toekick.  Not available on 93" or 96" tall cabinets due to separate pedestal base toekick.	No Upcharge
<b>Flush Toekick Furniture (FTKFV) (FTKFV.P) (FTKFV.FNT.P)</b>	Most base, tall, and vanity cabinets, and wall cabinets with ADDTK	Creates a furniture flush toe space. Valance replaces standard toekick creating a full open area beneath cabinet floor.  When FTKFV.FNT.P is ordered with the Peninsula modification, both sides will receive a furniture flush toekick.  When FTKFV.P is ordered with the Peninsula modification, only the peninsula side will receive a furniture flush toekick.  Not available on 93" or 96" tall cabinets due to separate pedestal base toekick.	No Upcharge

### FLUSH TOEKICK ARCH (FTKAV)

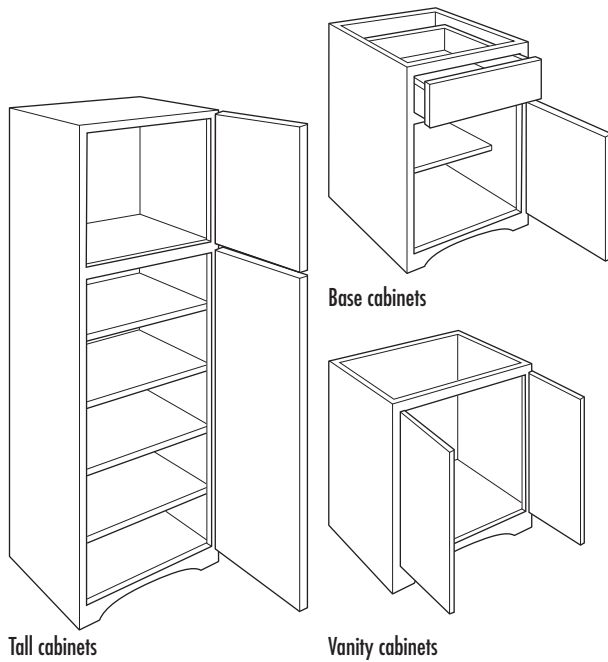

### FLUSH TOEKICK FURNITURE (FTKFV)

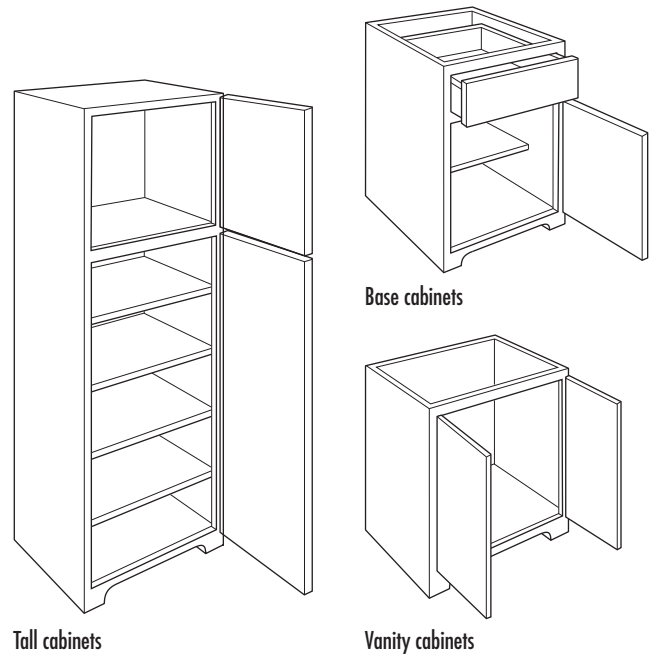

# TOEKICK MODIFICATIONS (cont'd)

See page 40 for modification compatibility. Each modification will be priced accordingly. Requests for non-published modifications may be treated as a Special Sales Order which will require feasibility, pricing and leadtime review and approval. Please check with your customer service representative before placing your order.

OPTION NAME	APPLICABLE CABINET GROUP	DESCRIPTION/LIMITATIONS	PRICING
<b>Loose Toekick (TKP)</b>	Most tall cabinets	Available on 84", 87", and 90" tall cabinets. Removes and ships the toekick separately. Not compatible with other toekick modifications.  Pedestal is designed to create a Recessed Left or Right Toekick (RECTKL or RECTKR) application during field installation, or can be centered. Pedestal must be covered with toeboard material.	No Upcharge
<b>Recessed Island Toekick (RECTKALL)</b>	Most base and vanity cabinets, and wall cabinets with ADDTK	Creates a 3 3/8" recessed toekick on the right, left, and back of cabinet. The entire toekick area will have non-matching material and requires any exposed toekick area to be covered.	No Upcharge
<b>Recessed Toekick on Back or Side (RECTKBK) (RECTKL) (RECTKR)</b>	Most base and vanity cabinets, and wall cabinets with ADDTK	Creates a 3 3/8" recessed toekick on the back (RECTKBK), left (RECTKL), or right (RECTKR). When either the RECTKR or RECTKL are used, FTK is NOT available. The entire toekick will have non-matching material and requires any exposed toekick area to be covered. On RECTKL and RECTKR, the back will have a 1/2" recessed offset and non-specified side will have a 1/2" recessed offset to allow for application of toeboard material.  93" and 96" tall cabinets have RECTKL or RECTKR standard on loose pedestal. For recess toekick applications of both left and right, order RECTKL.R. On 9" wide cabinets, only one side can be recessed. RECTKBK only available on cabinets at least 15" deep.	No Upcharge

## LOOSE TOEKICK (TKP)

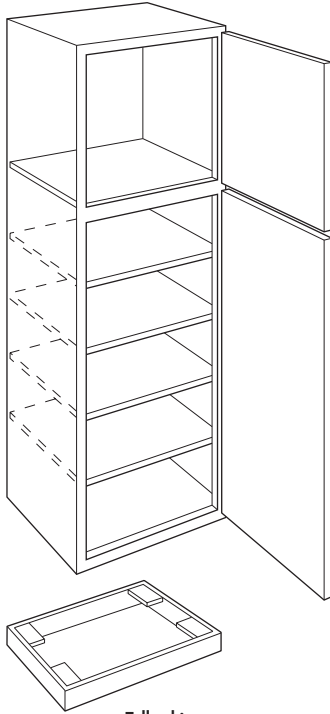

Tall cabinets

Pedestal is reduced in width for RECTKL or RECTKR during field installation.

## RECESSED ISLAND TOEKICK (RECTKALL)

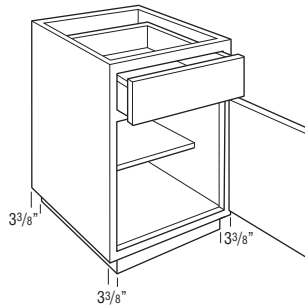

Base cabinets

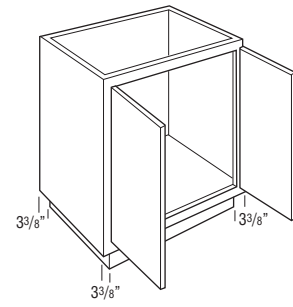

Vanity cabinets

## RECESSED TOEKICK - BACK (RECTKBK)

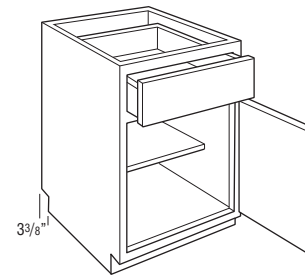

Base cabinets

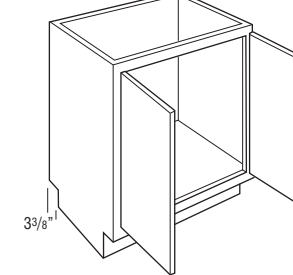

Vanity cabinets

## RECESSED TOEKICK - LEFT (RECTKL)

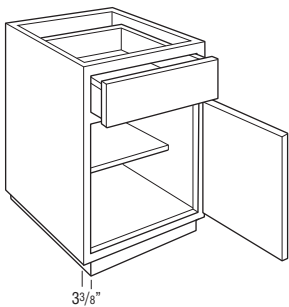

Base cabinets

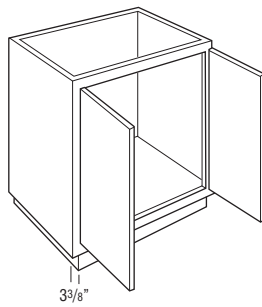

Vanity cabinets

## RECESSED TOEKICK - RIGHT (RECTKR)

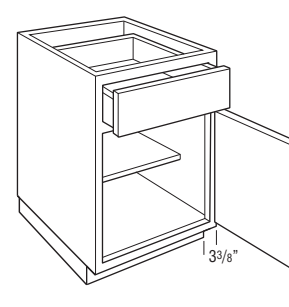

Base cabinets

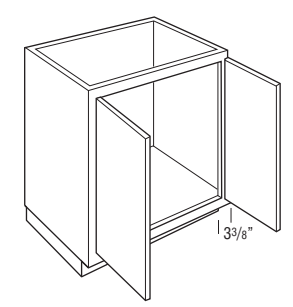

Vanity cabinets



## TOEKICK MODIFICATIONS (cont'd)

See page 40 for modification compatibility. Each modification will be priced accordingly. Requests for non-published modifications may be treated as a Special Sales Order which will require feasibility, pricing and leadtime review and approval. Please check with your customer service representative before placing your order.

OPTION NAME	APPLICABLE CABINET GROUP	DESCRIPTION/LIMITATIONS	PRICING
<b>Toekick Drawer (DRWTK)</b>	Most cabinets with a standard toekick, and wall cabinets with ADDTK	Replaces standard toekick with a toekick drawer. Available on most 21"-24" deep cabinets in 18", 21", 24", 27", 30", 33", and 36" widths that have standard toekick construction. Front of toekick drawer is unfinished, allow enough toeboard to cover. 1" clearance below toekick drawer. Exterior dimensions of drawer are 3 3/8" tall and 15" or 18" deep. Toekick drawer uses a push to open full extension side-mount guide, does not have soft-close feature.	\$539 list
<b>Void Toekick (VTK)</b>	Most base, tall, and vanity cabinets	Removes the toekick. Only available when the cabinet has a standard toekick (not available when flush toekick is standard or when cabinet has a separate pedestal base).  When VTK is specified on cabinets to be used with a countertop, cabinets must also be supported from the floor, not just attached to the wall. Failure to properly install cabinets in this situation will void the warranty.	No Upcharge

### TOEKICK DRAWER (DRWTK)

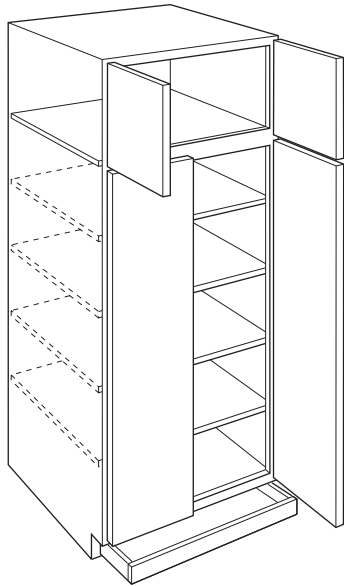

Tall cabinets

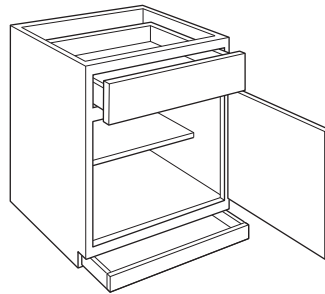

Base cabinets

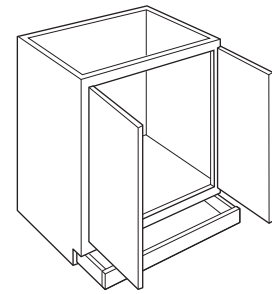

Vanity cabinets

### VOID TOEKICK (VTK)

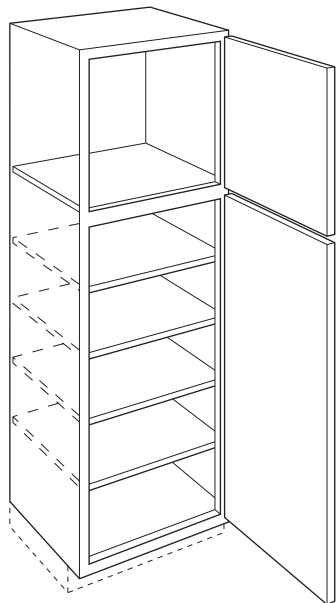

Tall cabinets

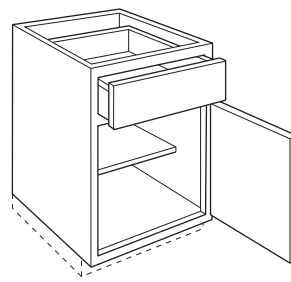

Base cabinets

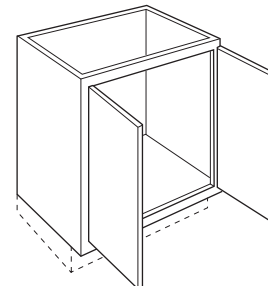

Vanity cabinets

# CONFIGURATION MODIFICATIONS

See page 40 for modification compatibility. Each modification will be priced accordingly. Requests for non-published modifications may be treated as a Special Sales Order which will require feasibility, pricing and leadtime review and approval. Please check with your customer service representative before placing your order.

OPTION NAME	APPLICABLE CABINET GROUP	DESCRIPTION/LIMITATIONS	PRICING
<b>Cabinet Front Only (CFNTO)</b>	Most cabinets with a face frame	Creates a door and/or drawer front assembled with a frame. Doors are attached with the specified hinges and drawer fronts are cleated.	Wall: 70% of cabinet list Base & Tall: 80% of cabinet list
<b>Cabinet Frame Only (CFRMO)</b>	Most cabinets with a face frame	Creates a cabinet frame only. No box, doors, or drawer fronts are included.	25% of cabinet list
<b>Peninsula (P)</b>	Most wall and base cabinets	Creates a peninsula cabinet that is 1/4" deeper than the standard cabinet depth. If ID or RD is specified, cabinet will be 1/4" deeper than specified cabinet depth. Any adjustable shelves are upgraded to full depth.  Any cabinet with a toekick must be at least 15" deep (either standard with a toekick or when ADDTK is specified).  Single door cabinets are hinged on the same cabinet end, for example a W1230L will feature a Left hinge on the front side and a Right hinge on the peninsula side.  Not available on tall cabinets (oven, utility, and pantry) or multi-drawer base cabinets.  Cabinets with drawers can only be reduced in 3" increments.  Peninsula cabinets are not designed to be used as stand alone island cabinets.	Cabinet list + 80%

## CABINET FRONT ONLY (CFNTO)

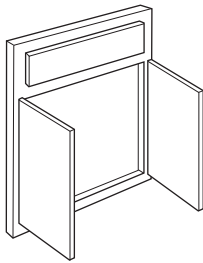

Cabinet front only – Wall, Base, and Tall

## CABINET FRAME ONLY (CFRMO)

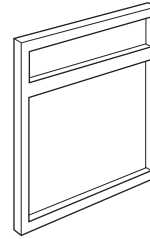

Cabinet frame only – Wall, Base, and Tall

## PENINSULA (P)

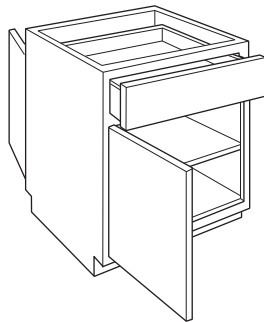

Base cabinets

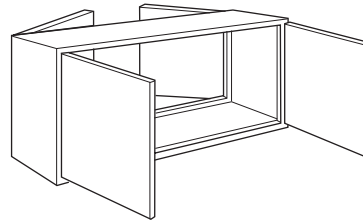

Wall cabinets

# ALUMINUM FRAME DOOR OPTIONS

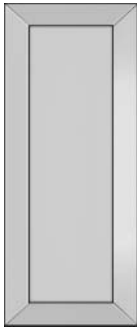

**ALF**  
Aluminum Frame Door  
in Aluminum finish  
with Frost glass



**ALFBS**  
Aluminum Frame Door  
with a Brushed Stainless  
Steel look with Frost glass



**ALFBL**  
Aluminum Frame Door  
with a Black powder coat  
finish with Frost glass

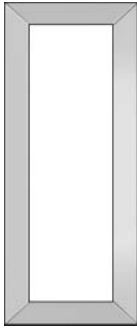

**ALFC**  
Aluminum Frame Door  
in Aluminum finish  
with Clear glass

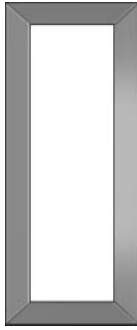

**ALFBSC**  
Aluminum Frame Door  
with a Brushed Stainless Steel  
look with Clear glass



**ALFBLC**  
Aluminum Frame Door  
with a Black powder coat  
finish with Clear glass

- All aluminum doors will be full overlay with miter construction.
- Cabinet face frame and end panels will be matched to the finish specified.
- Aluminum and Brushed Stainless doors have an anodized finish.
- Black doors have a powder coated finish.
- Glass and matching panel are installed in door, removal will void warranty.
- Door rails are 2 1/4" wide.
- All Aluminum Frame door options are represented by ALF in Door Options availability grids.
- Cabinet will have standard interior or can be ordered with MIP option. When a decorative door option is chosen in 20/20, Matching Interior Plywood (MIP) is a preselected option. If MIP is not desired, it can be deselected by choosing NOTMIP.

## ALF AVAILABILITY

Cabinet Width	Cabinet Height					
	12"	15"	18"	21"	30"	36"
W12	N/A	N/A	N/A	N/A	B	C
W15	A	A	N/A	N/A	B	C
W18	A	A	N/A	N/A	B	C
W21	N/A	N/A	N/A	N/A	B	C
WTH30 & WTH30..24	B	B	B	B	N/A	N/A
WVL30 & WVL30..24	N/A	N/A	B	B	N/A	N/A
WTH36 & WTH36..24	C	C	C	C	N/A	N/A
WVL36 & WVL36..24	N/A	N/A	C	C	N/A	N/A

## ALF LIST PRICE PER DOOR

Code	A	B	C
ALF	564	626	689
ALFC	564	626	689
ALFBS	988	1047	1108
ALFBSC	988	1047	1108
ALFBL	1145	1204	1265
ALFBLC	1145	1204	1265

To price ALF door attached to a cabinet, add the list price per door to the cabinet price (MIP modification upcharge will be applied to the cabinet price if matching interior is desired).

For a door only (not specified on a cabinet), add the list price for a door only to the Aluminum Frame door list price. See Doors and Drawer Fronts on page 591 for details.

# CUT-FOR-GLASS DOORS (CG)

Arch and Square - Glass not included

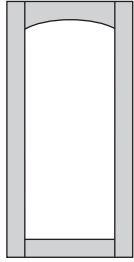

Cut-for-glass Arch

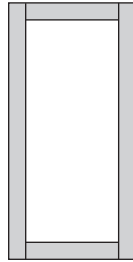

Cut-for-glass Square

- Not available in Aspen, Derazi, Gallio, Herra, Prestley, and Rivali.
- If desired for use with Prestley, using a shaker style such as Elston, Huxley, or Pleasant Hill is recommended.
- If ordered in an MDF door style, door will be Maple. On Stacked Wall (STW\_\_ ) and Utility cabinets (U\_\_ ), all cabinet doors will be Maple when ordered with a Cut-for-glass Door.
- Not available on bifold doors.
- Specify Arch/Square, Door Style, and Finish when ordering Cut-for-glass Doors.
- Custom door sizes available. See pages 534-538.
- Glass clips included with door, but glass is not included.
- For cabinet availability, please see modification grids.
- CG.TOP and CG.BTM are specified on cabinets with upper and lower doors to designate which doors should be Cut-for-glass. See Door Options grid for SKU availability.
- When a decorative door option is chosen in 20/20, Matching Interior Plywood (MIP) is a preselected option. If MIP is not desired, it can be deselected by choosing NOTMIP.

## MODEL

## PRICE

List per Door

### Cut-for-glass Door To Fit

96

To price Cut-for-glass Doors attached to a cabinet, add the list price per door to the cabinet price (MIP modification upcharge will be applied to the cabinet price if matching interior is desired).

For a door only (not specified on a cabinet), add the list price for a door only to the Cut-for-glass door list price. See Doors and Drawer Fronts on page 591 for details.

# MULLION DOORS (MD)

Arch and Square - Tempered glass included

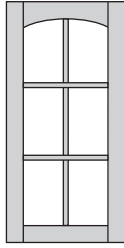

Mullion Arch

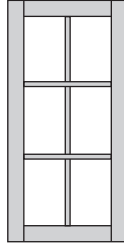

Mullion Square

- Available in all door styles except Aspen, Campbell, Derazi, Gallio, Herra, Kennedy, Prestley, and Rivali.
- Custom Door Sizes not available.
- For Mullion Door availability, please see modification grids in wall section.
- If ordered in an MDF door style, door will be Maple.
- Pricing includes Mullion Door and fully tempered clear glass for safety.
- Textured glass may be ordered to replace clear glass, except Bevel. See page 70 for textured glass pricing.
- On acknowledgment, textured glass will be listed with MDI modification.
- MD.TOP and MD.BTM are specified on cabinets with upper and lower doors to designate which doors should be Mullion Doors. See Door Options grid for SKU availability.
- Shelves will not align with mullions.
- Galena mullion doors are not available with Modified Full Overlay (MFO).
- When a decorative door option is chosen in 20/20, Matching Interior Plywood (MIP) is a preselected option. If MIP is not desired, it can be deselected by choosing NOTMIP.

MODEL	PRICE
Mullion Door Only To Fit:	List per Door
18" High Wall Cabinet	587
24" High Wall Cabinet	587
30" High Wall Cabinet	587
33" High Wall Cabinet	626
36" High Wall Cabinet	626
39" High Wall Cabinet	663
42" High Wall Cabinet	663

To price Mullion Doors attached to a cabinet, add the list price per door to the wall cabinet price (MIP modification upcharge will be applied to the cabinet price if matching interior is desired).

For a door only (not specified on a cabinet), add the list price for a door only to the Mullion door list price. See Doors and Drawer Fronts on page 591 for details.

## MULLION ARCH/SQUARE LITES GRID

Cabinet Width	Cabinet Height						
	18"	24"	30"	33"	36"	39"	42"
W15	G		D	D	D	A	A
W18	G		D	D	D	A	A
W21			D or E	D or E	D or E	A or B	A or B
W24			D or E	D or E	D or E	A or B	A or B
W24 (butt)			D	D	D	A	A
W27 (butt)			D	D	D	A	A
W30 (butt)	G	G	D	D	D	A	A
W33 (butt)			D	D	D	A	A
W36 (butt)	G	G	D	D	D	A	A
W42			D or E	D or E	D or E	A or B	A or B
W45			D or E	D or E	D or E	A or B	A or B
W48 (butt)			D	D	D	A	A
WC33			D	D	D	A	A
WC36			D	D	D	A	A
WC39			D	D	D	A	A
WC42			D	D	D	A	A
WC45			D	D	D	A	A
WC48			D	D	D	A	A
DW30/DW30T			D				
DW33/DW33T				D			
DW36/DW36T					D		
DW39/DW39T						A	
DW42/DW42T							A

## Mullion Door Configurations

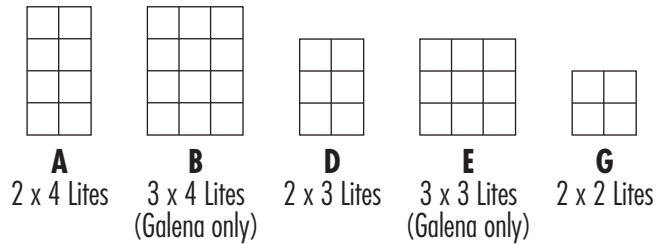

# SHAKER MULLION DOORS (SHMD)

Tempered glass included

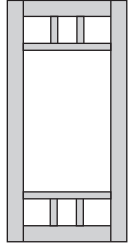

- Available in Elston, Huxley, Morgan, Pleasant Hill, and Whitaker.
- Custom Door Sizes not available.
- Shelves will not align with mullions.
- For Mullion Door availability, please see modification grids in wall section.
- If ordered in an MDF door style, door will be Maple.
- Pricing includes Mullion Door and fully tempered clear glass for safety.
- Textured glass may be ordered to replace clear glass, except Bevel. See page 70 for textured glass pricing.
- On acknowledgment, textured glass will be listed with SHMDI modification.
- When a decorative door option is chosen in 20/20, Matching Interior Plywood (MIP) is a preselected option. If MIP is not desired, it can be deselected by choosing NOTMIP.

MODEL	PRICE
<b>Mullion Door Only To Fit:</b>	List per Door
<b>18" High Wall Cabinet</b>	587
<b>24" High Wall Cabinet</b>	587
<b>30" High Wall Cabinet</b>	587
<b>33" High Wall Cabinet</b>	626
<b>36" High Wall Cabinet</b>	626
<b>39" High Wall Cabinet</b>	663
<b>42" High Wall Cabinet</b>	663

To price *Shaker Mullion Doors* attached to a cabinet, add the list price per door to the wall cabinet price (MIP modification upcharge will be applied to the cabinet price if matching interior is desired).

For a door only (not specified on a cabinet), add the list price for a door only to the *Shaker Mullion door* list price. See *Doors and Drawer Fronts* on page 591 for details.

### MULLION SHAKER LITES GRID

Cabinet Width	Cabinet Height						
	18"	24"	30"	33"	36"	39"	42"
W15 <sup>†</sup>	H		H	H	H	H	H
W18	H		H	H	H	H	H
W21			H	H	H	H	H
W24			H	H	H	H	H
W24 (butt)			J	J	J	J	J
W27 (butt)			J	J	J	J	J
W30 (butt) <sup>†</sup>	H	H	H	H	H	H	H
W33 (butt)			H	H	H	H	H
W36 (butt)	H	H	H	H	H	H	H
W42			H	H	H	H	H
W45			H	H	H	H	H
W48 (butt)			J	J	J	J	J
WC33			H	H	H	H	H
WC36			H	H	H	H	H
WC39			J	H	H	H	H
WC42			J	H	H	H	H
WC45			J	H	H	H	H
WC48			H	H	H	H	H
DW30/DW30T			H				
DW33/DW33T				H			
DW36/DW36T					H		
DW39/DW39T						H	
DW42/DW42T							H

### Shaker Mullion Door Configurations

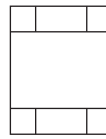

**H**  
3 x 3 Lites

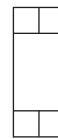

**J**  
2 x 3 Lites

<sup>†</sup>Elston and Huxley will have "J Configuration" for 15" and 30" wide cabinets and all DW cabinets.

# PRAIRIE MULLION DOORS (PRMD)

Tempered glass included

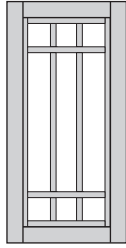

- Available in Elston, Huxley, Morgan, Pleasant Hill, and Whittaker.
- Custom Door Sizes not available.
- Shelves will not align with mullions.
- For Mullion Door availability, please see modification grids in wall section.
- If ordered in an MDF door style, door will be Maple.
- Pricing includes Mullion Door and fully tempered clear glass for safety.
- Textured glass may be ordered to replace clear glass, except Bevel. See page 70 for textured glass pricing.
- On acknowledgment, textured glass will be listed with PRMDI modification.
- When a decorative door option is chosen in 20/20, Matching Interior Plywood (MIP) is a preselected option. If MIP is not desired, it can be deselected by choosing NOTMIP.

## MULLION PRAIRIE LITES GRID

Cabinet Width	Cabinet Height						
	18"	24"	30"	33"	36"	39"	42"
W15†	K		K	K	K	K	K
W18	K		K	K	K	K	K
W21			K	K	K	K	K
W24			K	K	K	K	K
W24 (butt)			L	L	L	L	L
W27 (butt)			L	L	L	L	L
W30 (butt)†	K	K	K	K	K	K	K
W33 (butt)			K	K	K	K	K
W36 (butt)	K	K	K	K	K	K	K
W42			K	K	K	K	K
W45			K	K	K	K	K
W48 (butt)			L	L	L	L	L
WC33			K	K	K	K	K
WC36			K	K	K	K	K
WC39			L	K	K	K	K
WC42			L	K	K	K	K
WC45			L	K	K	K	K
WC48			K	K	K	K	K
DW30/DW30T			K				
DW33/DW33T				K			
DW36/DW36T					K		
DW39/DW39T						K	
DW42/DW42T							K

†Elston and Huxley will have "L Configuration" for 15" and 30" wide cabinets and all DW cabinets.

## Prairie Mullion Door Configurations

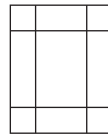

**K**  
3 x 3 Lites



**L**  
2 x 3 Lites

MODEL	PRICE
Mullion Door Only To Fit:	List per Door
18" High Wall Cabinet	587
24" High Wall Cabinet	587
30" High Wall Cabinet	587
33" High Wall Cabinet	626
36" High Wall Cabinet	626
39" High Wall Cabinet	663
42" High Wall Cabinet	663

To price Prairie Mullion Doors attached to a cabinet, add the list price per door to the wall cabinet price (MIP modification upcharge will be applied to the cabinet price if matching interior is desired).

For a door only (not specified on a cabinet), add the list price for a door only to the Prairie Mullion door list price. See Doors and Drawer Fronts on page 591 for details.

# ART GLASS PANELS



Anson

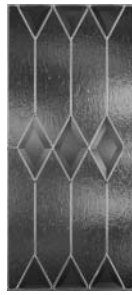

Avondale

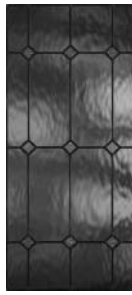

Cambridge



Charlotte



Lanai

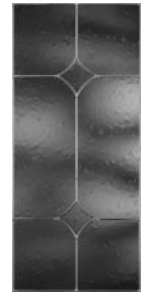

Lonsdale

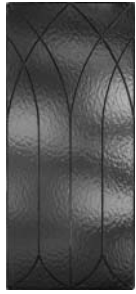

Lyndhurst

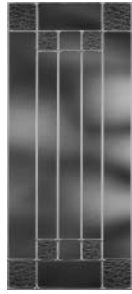

Pavillion

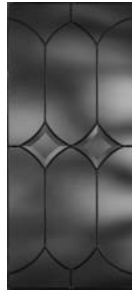

Portico

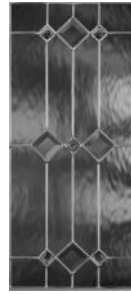

Quincy



Waterbury

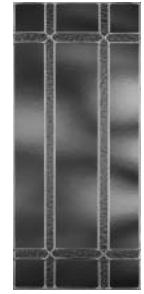

Wickford

- Cut-for-glass door must be ordered separately. See page 62 for door style availability.
- For glass shelf kits, see page 570.
- Door frame may reduce amount of glass shown.
- No changes or cancellations will be accepted after 24 hours from acknowledgment of order.
- Art glass will be packaged separately from applicable cabinet(s) and shipped with cabinet order for field installation.

STYLE	PANEL THICKNESS	CAGING MATERIAL	HEIGHT		
			12", 15", 18" TALL	21", 24", 27", 30" TALL	33", 36", 39", 42" TALL
Anson	1/4"	Zinc Black Patina	449	499	549
Avondale	1/4"	Zinc	674	748	824
Cambridge	1/4"	Zinc Black Patina	505	562	619
Charlotte	1/4"	Zinc	604	671	739
Lanai	1/4"	Zinc	604	671	739
Lonsdale	1/4"	Zinc	449	499	549
Lyndhurst	1/4"	Zinc Black Patina	579	643	707
Pavillion	1/4"	Zinc	403	447	493
Portico	1/4"	Zinc Black Patina	505	562	619
Quincy	1/4"	Zinc	505	562	619
Waterbury	1/4"	Zinc Black Patina	535	593	653
Wickford	1/4"	Zinc	505	562	619



# ART GLASS PANELS

## Anson

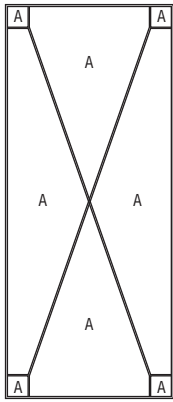

Minimum Size  
6" x 6"

$1\frac{3}{8}$ "  
□  $1\frac{3}{8}$ "

Glass Type:  
A) Clear Seedy 100SDY

Metal Type:  
 $\frac{3}{16}$ " H-Ch Zinc Proglaze2 (all)  
Black Patina Finish

- Suggested to use with Square doors.

## Cambridge

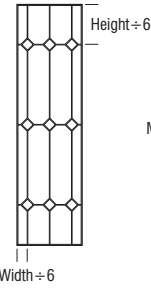
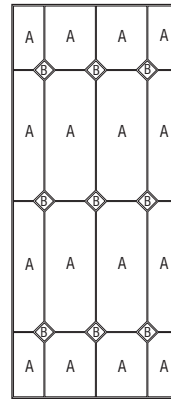

Minimum Size 6" x 10"

$\frac{7}{8}$ " Sq.

Glass Types:  
A) Clear Waterglass 100W  
B) Clear Sparkolite

Metal Type:  
 $\frac{3}{16}$ " H-Ch Zinc Proglaze2 (all)  
Black Patina Finish

## Avondale

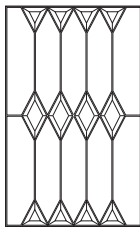
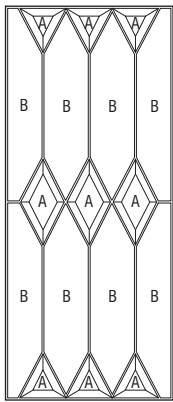

Widths > 13"  
4 Vertical Columns

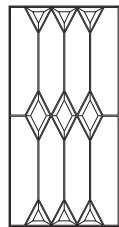

Widths > 10" to 13"  
3 Vertical Columns

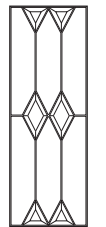

Widths > 7" to 10"  
2 Vertical Columns



Heights < 13"  
Diamond(s) Only

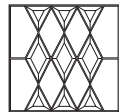

Heights > 13"  
Full Design



Minimum Size  
6" x 6 $\frac{1}{4}$ "



Widths 6" to 7"  
1 Vertical Column

Glass Types:  
A)  $\frac{3}{16}$ " Clear with  $\frac{1}{2}$ " Bevel  
B) Clear Vecchio 100V

Metal Type:  
 $\frac{3}{16}$ " H-Ch Zinc Proglaze2 (all)

- Suggested to use with Square doors.

## Charlotte

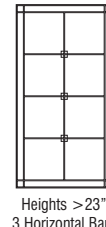
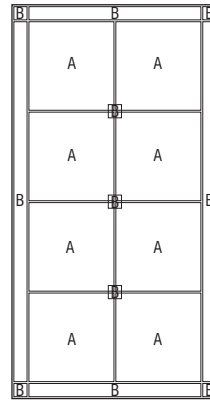

Heights > 23"  
3 Horizontal Bars

Overlay  
 $1\frac{9}{16}$ " x  $1\frac{5}{16}$ "

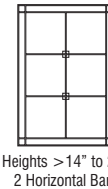

Heights > 14" to 23"  
2 Horizontal Bars

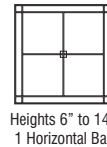

Heights 6" to 14"  
1 Horizontal Bar

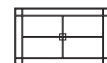

Minimum Size  
10" x 6"

Glass Types:  
A)  $\frac{1}{8}$ " Clear  
B) Frost Etch 100

Metal Types:  
 $\frac{3}{16}$ " H-Ch Zinc Proglaze2 (all)  
 $\frac{1}{8}$ " U-Ch Zinc (overlays)

- Suggested to use with Square doors.

# ART GLASS PANELS

## Lanai

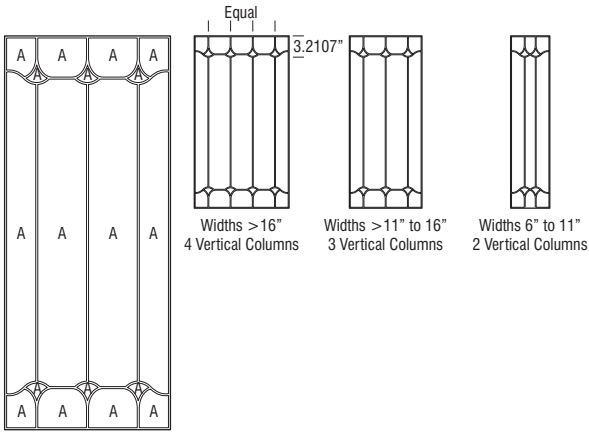

Glass Type:  
A) 1/8" Clear  
Metal Type:  
3/16" H-Ch Zinc Proglaze2 (all)

## Lyndhurst

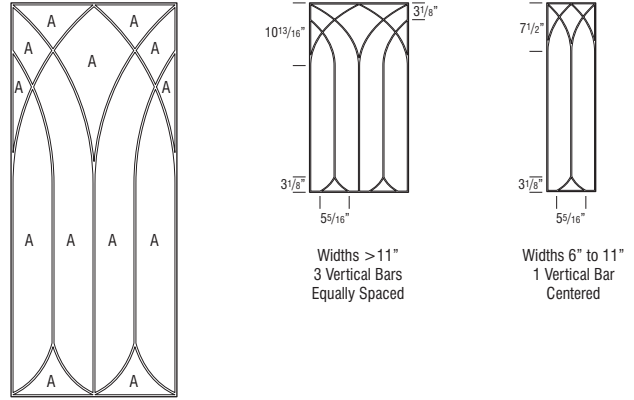

Glass Type:  
A) Clear Rough Rolled 100RR  
Metal Type:  
3/16" H-Ch Zinc Proglaze2 (all)  
Black Patina Finish  
Minimum Size 6" x 12"

## Lonsdale

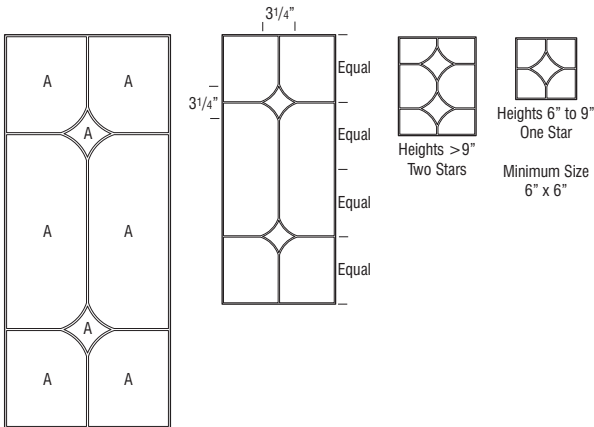

Glass Type:  
A) Seedy Clear 100Sdy  
Metal Type:  
3/16" H-Ch Zinc Proglaze2 (all)

## Pavillion

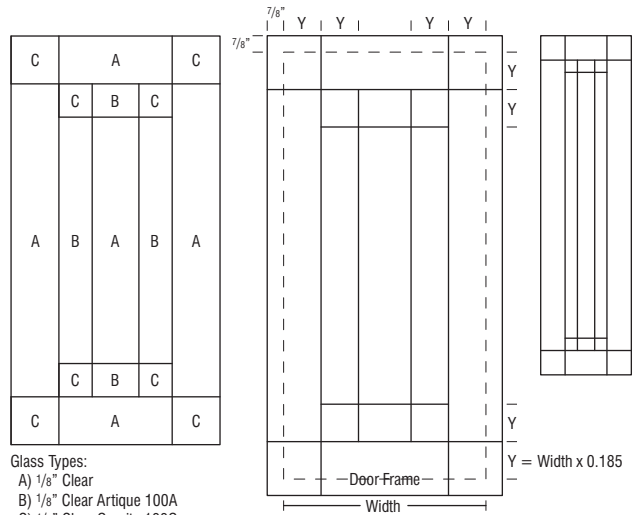

Glass Types:  
A) 1/8" Clear  
B) 1/8" Clear Artique 100A  
C) 1/8" Clear Granite 100G  
Metal Type:  
3/16" H-Ch Round Zinc Proglaze2 (all)

- Suggested to use with Square doors.

# ART GLASS PANELS

## Portico

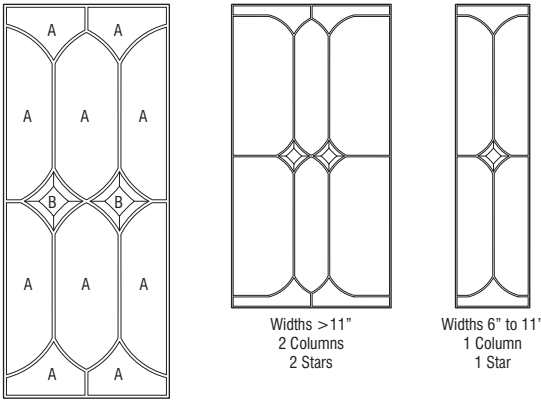

Glass Types:  
 A) 1/8" Clear  
 B) 3/16" Clear with 1/2" Bevel

Metal Type:  
 3/16" H-Ch Zinc Proglaze2 (all)  
 Black Patina Finish

Minimum Size 6" x 12"

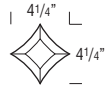

## Waterbury

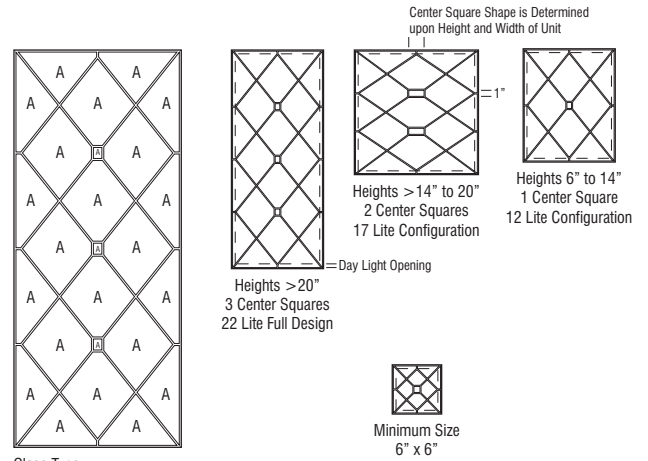

Glass Type:  
 A) Clear Waterglass 100W

Metal Type:  
 3/16" H-Ch Zinc Proglaze2 (all)  
 Black Patina Finish

## Quincy

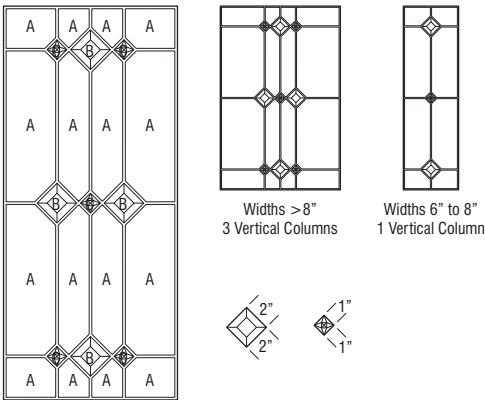

Glass Types:  
 A) Clear Waterglass 100W  
 B) 3/16" Clear with 1/2" Bevel  
 C) Clear Faceted Jewel

Metal Type:  
 3/16" H-Ch Zinc Proglaze2 (all)  
 Minimum Size 6" x 10"

- Suggested to use with Square doors.

## Wickford

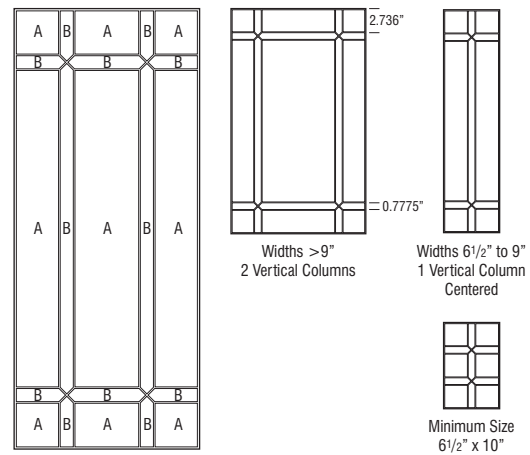

Glass Types:  
 A) Clear Artique 100A  
 B) Clear Granite 100G

Metal Type:  
 3/16" H-Ch Round Zinc Proglaze2 (all)

- Suggested to use with Square doors.

# INSTALLED TEXTURED GLASS PANELS



Antique



Bevel



Centurian



Clear



Frost



Hammered

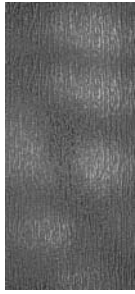

Rain

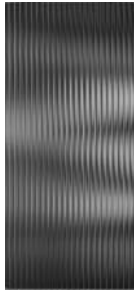

Reeded



Rice Paper



Seeded



Silhouette

- Cut-for-glass door must be ordered separately. See page 62 for door style availability.
- For glass shelf kits, see page 570.
- On order acknowledgment, decorative glass selection will be shown with selected CG modification.
- When textured glass is ordered for use in wall top hinge (WTH) or wall vertical-lift (WVL) cabinets, glass design will be turned horizontally and may not match desired pattern.
- All glass is fully tempered or has a safety lamination.
- Textured glass panels will be factory installed when ordered with a CG door.
- Door frame may reduce amount of glass shown.
- No changes or cancellations will be accepted after 24 hours from acknowledgment of order.

STYLE	PANEL THICKNESS	HEIGHT		
		12", 15", 18" TALL	21", 24", 27", 30" TALL	33", 36", 39", 42" TALL
Antique	1/8"	215	239	262
Bevel	1/4"	215	239	262
Centurian	1/8"	280	310	341
Clear	1/8"	182	202	222
Frost	5/32"	215	239	262
Hammered	5/32"	182	202	222
Rain	5/32"	338	376	414
Reeded	5/32"	182	202	222
Rice Paper	9/32"	443	493	541
Seeded	9/32"	338	376	414
Silhouette	1/8"	280	310	341

# INSTALLED TEXTURED GLASS PANELS

## Antique



- Glass type: Antique
- Panel thickness: 1/8"

## Clear



- Glass type: Clear
- Panel thickness: 1/8"

## Bevel

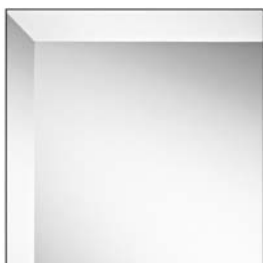

- Glass type: Clear
- Panel thickness: 1/4"
- Suggested to use with Square doors.
- Not compatible with Mullion Doors.

## Frost



- Glass type: Frost
- Panel thickness: 5/32"

## Centurian

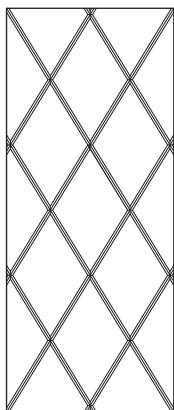

Maximum Size 24" x 48"

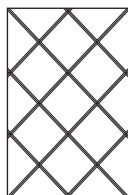

All Sizes Configured  
to 17 Lite



Minimum Size  
7 1/2" x 8"

- Glass type: Frost Etch
- Panel thickness: 1/8"

## Hammered

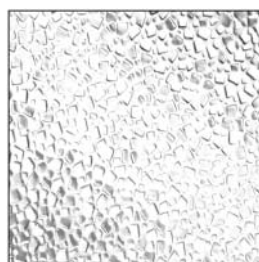

- Glass type: Hammered
- Panel thickness: 5/32"

# INSTALLED TEXTURED GLASS PANELS

## Rain

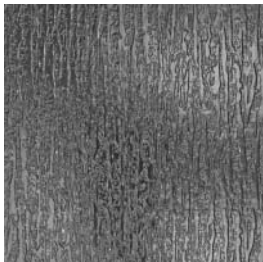

- Glass type: Rain
- Panel thickness: 5/32"

## Seeded

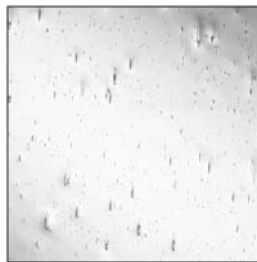

- Glass type: Seeded
- Panel thickness: 9/32"

## Reeded

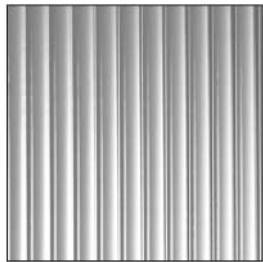

- Glass type: Reeded
- Panel thickness: 5/32"

## Silhouette

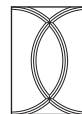
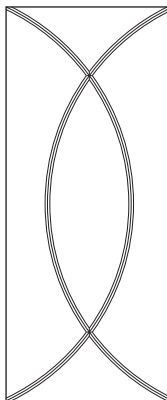

Minimum Size  
6" x 8 1/2"

- Glass type: Frost Etch
- Panel thickness: 1/8"
- Suggested to use with Square doors.

## Rice Paper

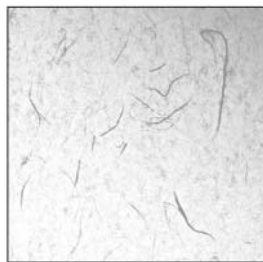

- Glass type: Rice Paper
- Panel thickness: 9/32"

# CABINET DIMENSIONS

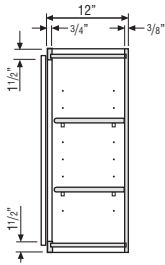

**WALL CABINET**

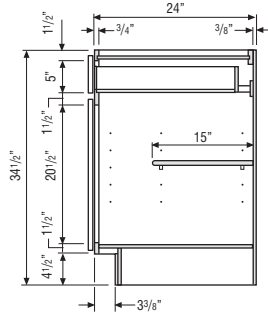

**BASE CABINET**

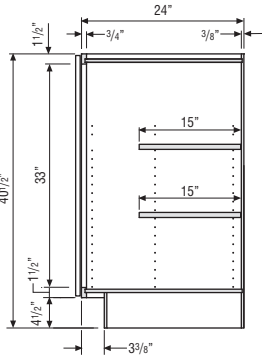

**40 1/2" HIGH  
FULL HEIGHT  
BASE CABINET**

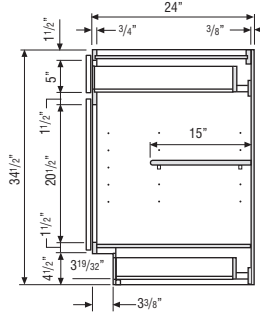

**BASE CABINET  
with TOEKICK DRAWER**

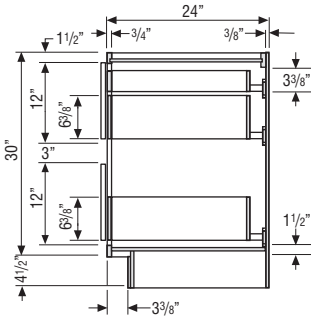

**TWO-DRAWER  
BASE CABINET  
with ROLL TRAY**

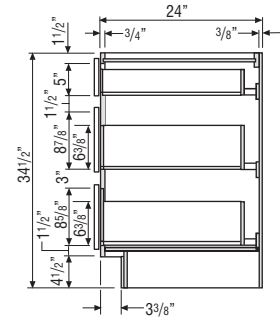

**THREE-DRAWER  
BASE CABINET**

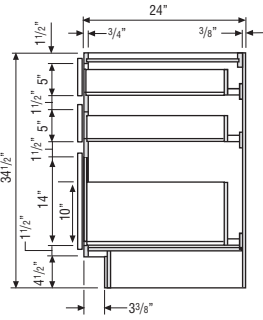

**THREE-DRAWER  
BASE CABINET  
with DEEP DRAWER**

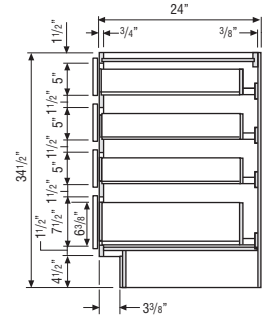

**FOUR-DRAWER  
BASE CABINET**

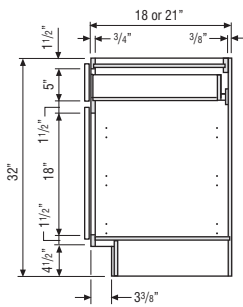

**32" HIGH  
VANITY CABINET**

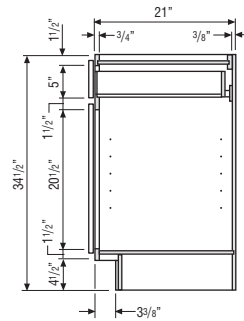

**34 1/2" HIGH  
VANITY CABINET**

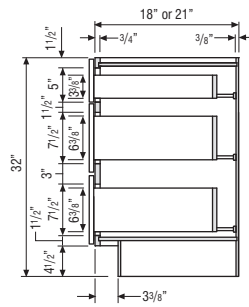

**32" HIGH  
VANITY DRAWER  
BASE CABINET**

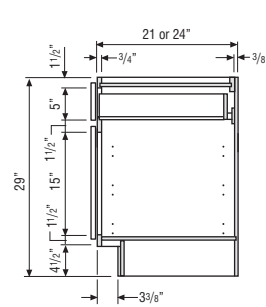

**DESK BASE CABINET**

# CABINET DIMENSIONS

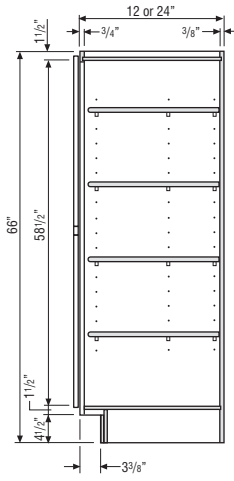

**UTILITY CABINET**

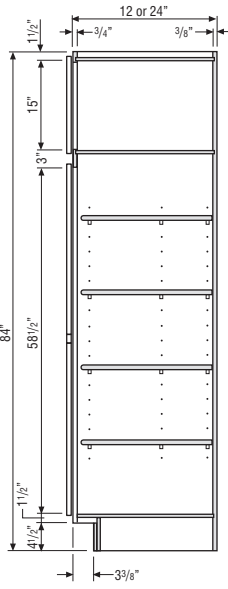

**UTILITY CABINET**

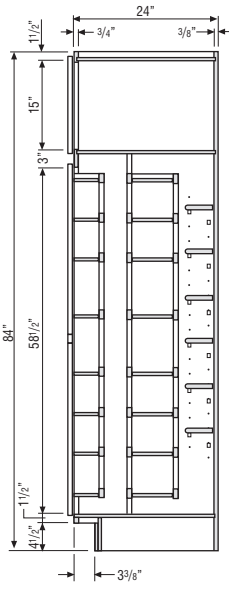

**PANTRY CABINET**

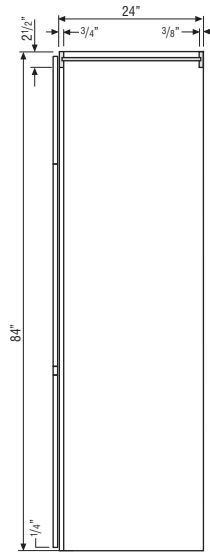

**PANTRY WALK-THROUGH**

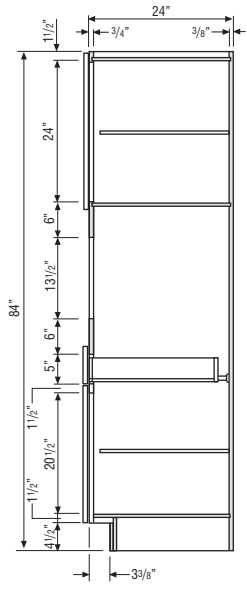

**TALL BUILT-IN MICROWAVE CABINET**

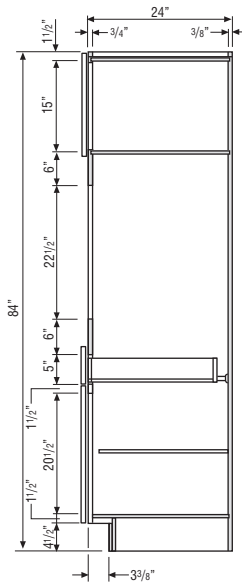

**SINGLE OVEN CABINET**

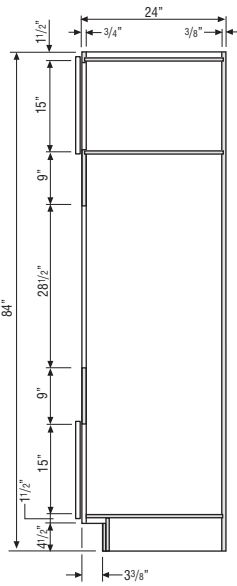

**OVEN MICROWAVE COMBO CABINET**

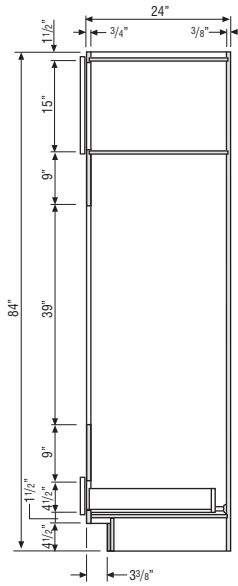

**DOUBLE OVEN CABINET**

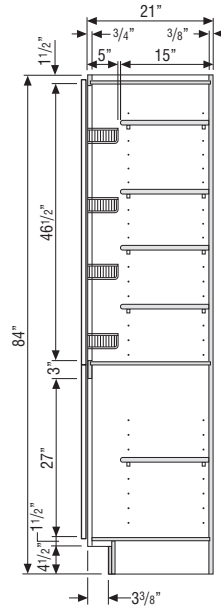

**LC/LCRH CABINET**

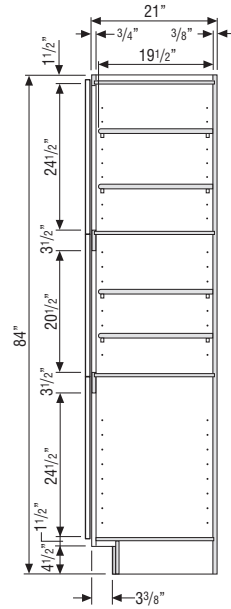

**VANITY UTILITY CABINET**



# CABINET DIMENSIONS

## ROLL TRAY POSITIONS

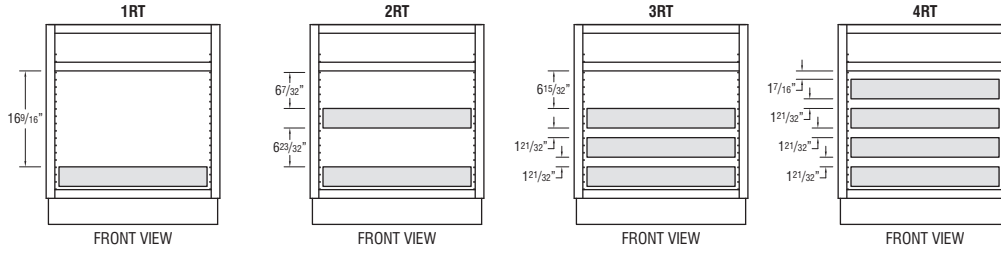

## BASE CABINETS AND 34 1/2" HIGH VANITY CABINETS

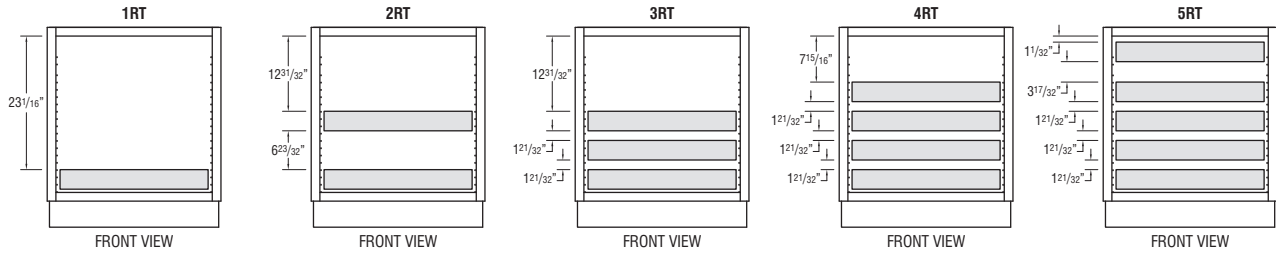

## FULL HEIGHT BASE CABINETS

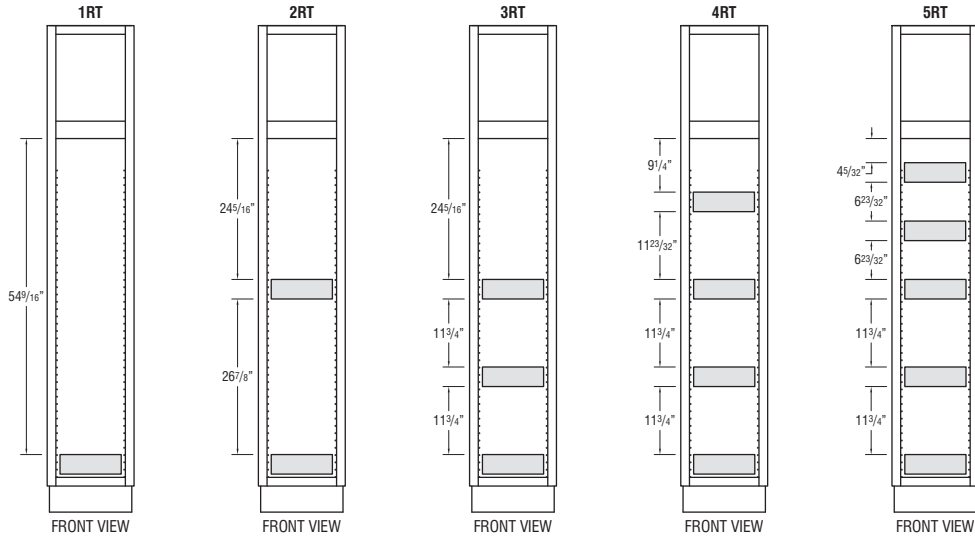

## UTILITY CABINETS

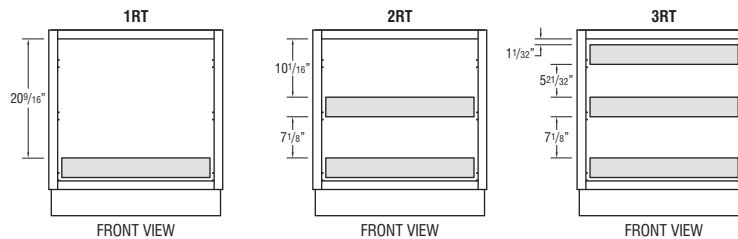

## 32" HIGH VANITY CABINETS

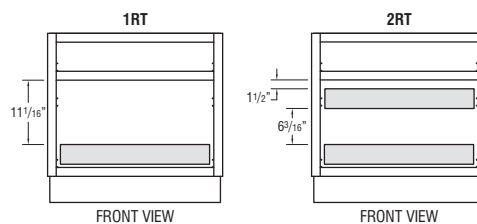

## DESK DOOR DRAWER BASE CABINETS

# CABINET DIMENSIONS

## 84" HIGH APPLICATION

Number after Wall Cabinet Represents Height of Cabinet

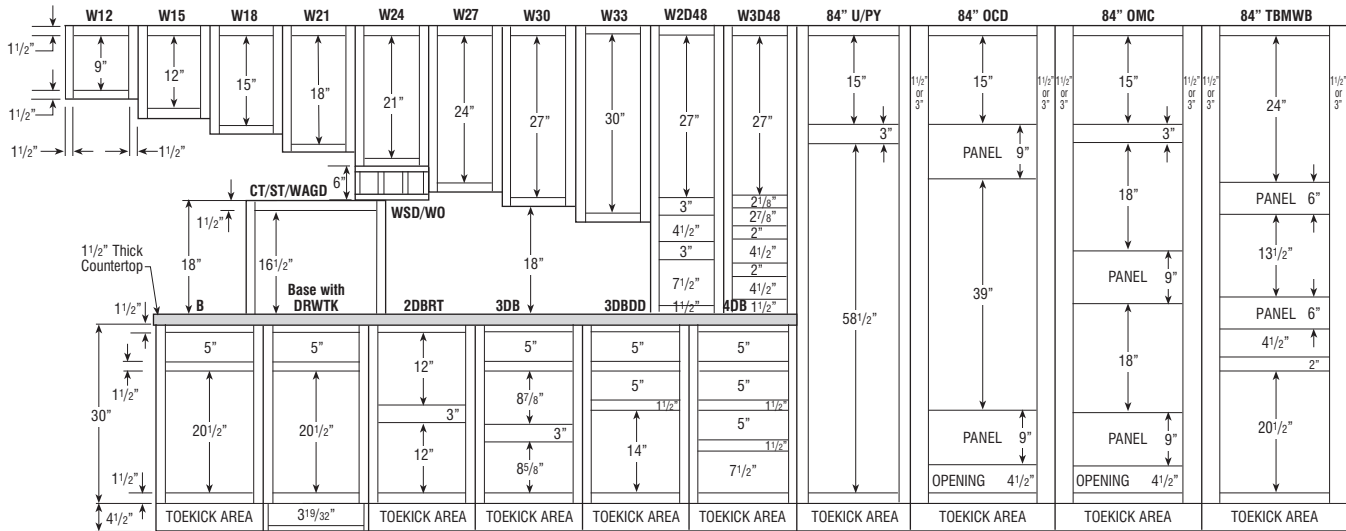

## 87" HIGH APPLICATION

Number after Wall Cabinet Represents Height of Cabinet

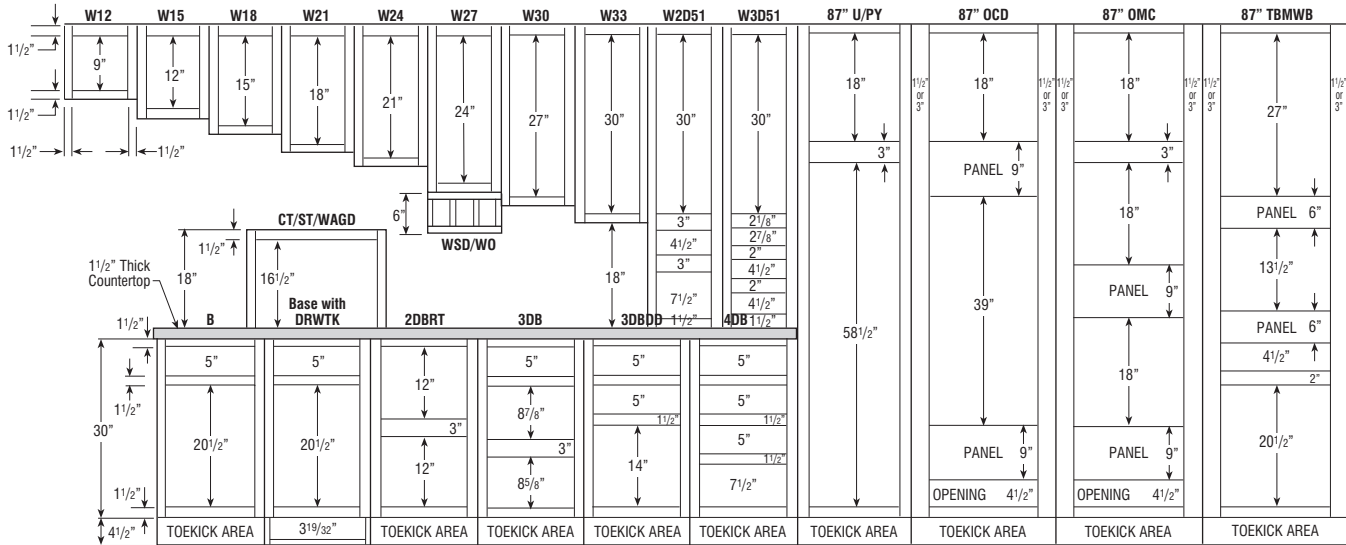

- 1 1/2" Top and Bottom Rails - Wall and Base Cabinets.
- 1 1/2" Vertical Stiles.
- 3" Center Vertical Rails on Wall and Base Cabinets to Divide Double Door Cabinets on 39" Wide and Over.

### Full Overlay Door Styles:

- 1/4" Reveal Around Doors (1/4" of Face Frame Shows).
- Frame Opening + 2 1/2" = Door Size for Base/Wall Cabinets.
- 4 1/2" or 5" High Drawer Opening = 6 1/4" Drawer Front.
- 7 1/2" High Drawer Opening = 10" Drawer Front.
- 8 5/8" and 8 7/8" Drawer Opening = 11 3/8" Drawer Front.

### 1/2" Overlay Door Styles:

- 1" Reveal Around Doors (1" of Face Frame Shows).
- Frame Opening + 1" = Door Size for Base/Wall Cabinets.
- 4 1/2" or 5" High Drawer Opening = 5 1/2" Drawer Front.
- 7 1/2" High Drawer Opening = 8 1/2" Drawer Front.
- 8 5/8" Drawer Opening = 9 7/8" Drawer Front.
- 8 7/8" Drawer Opening = 10 5/8" Drawer Front.

# CABINET DIMENSIONS

## 90" HIGH APPLICATION

Number after Wall Cabinet Represents Height of Cabinet

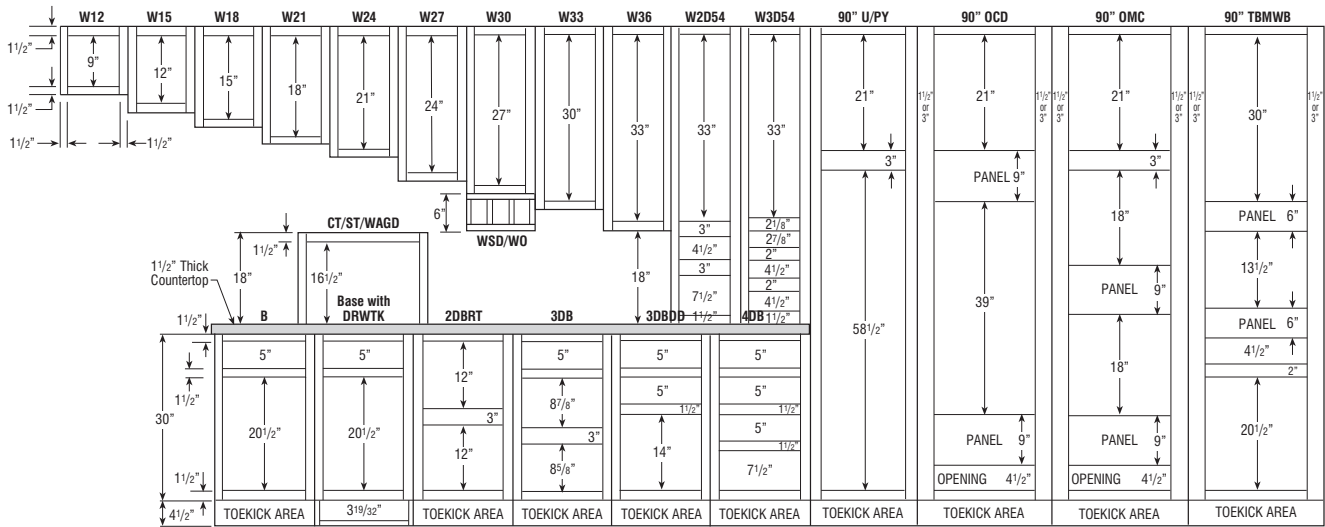

## 93" HIGH APPLICATION

Number after Wall Cabinet Represents Height of Cabinet

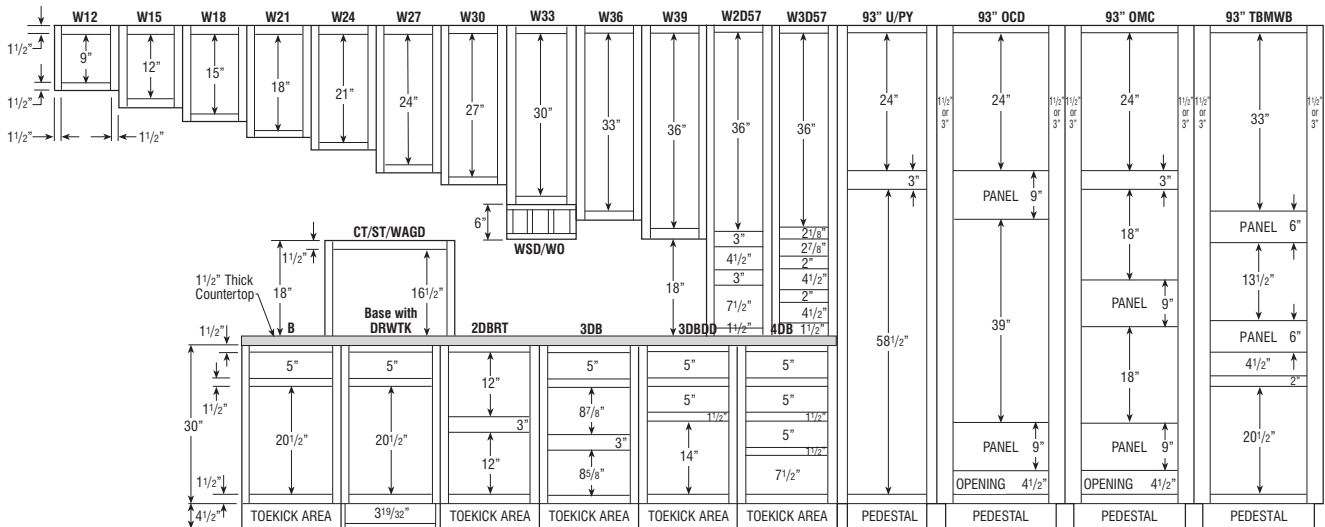

- 1 1/2" Top and Bottom Rails - Wall and Base Cabinets.
- 1 1/2" Vertical Stiles.
- 3" Center Vertical Rails on Wall and Base Cabinets to Divide Double Door Cabinets on 39" Wide and Over.

### Full Overlay Door Styles:

- 1/4" Reveal Around Doors (1/4" of Face Frame Shows).
- Frame Opening + 2 1/2" = Door Size for Base/Wall Cabinets.
- 4 1/2" or 5" High Drawer Opening = 6 1/4" Drawer Front.
- 7 1/2" High Drawer Opening = 10" Drawer Front.
- 8 5/8" and 8 7/8" Drawer Opening = 11 3/8" Drawer Front.

### 1/2" Overlay Door Styles:

- 1" Reveal Around Doors (1" of Face Frame Shows).
- Frame Opening + 1" = Door Size for Base/Wall Cabinets.
- 4 1/2" or 5" High Drawer Opening = 5 1/2" Drawer Front.
- 7 1/2" High Drawer Opening = 8 1/2" Drawer Front.
- 8 5/8" Drawer Opening = 9 7/8" Drawer Front.
- 8 7/8" Drawer Opening = 10 5/8" Drawer Front.

# CABINET DIMENSIONS

## 96" HIGH APPLICATION

Number after Wall Cabinet Represents Height of Cabinet

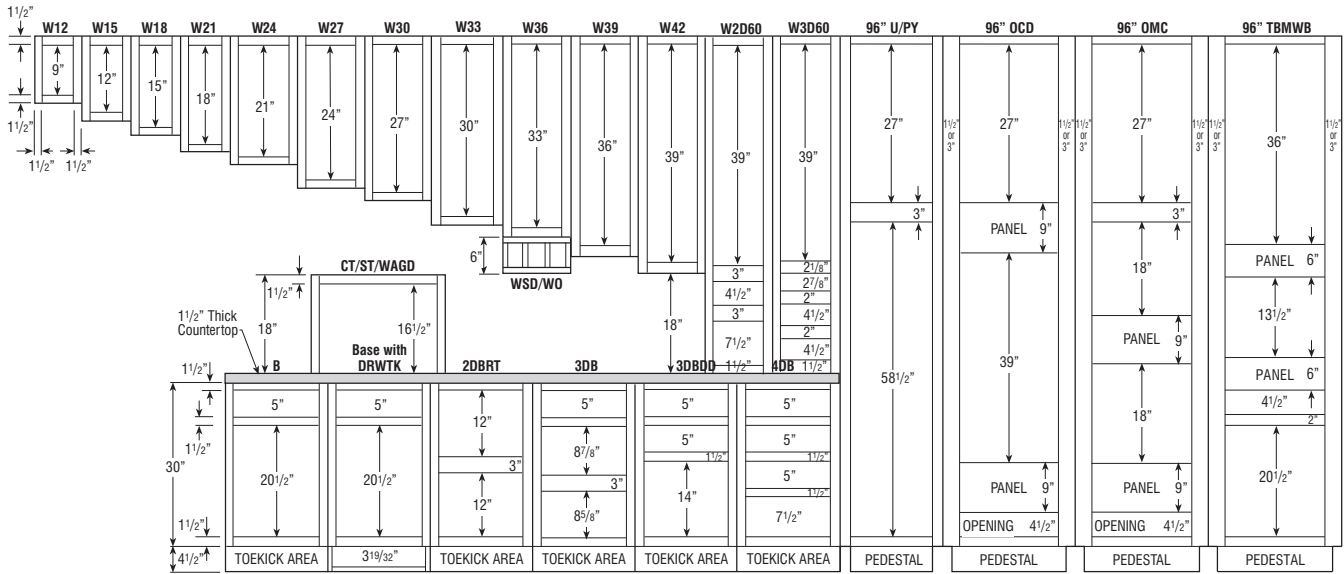

- 1 1/2" Top and Bottom Rails - Wall and Base Cabinets.
- 1 1/2" Vertical Stiles.
- 3" Center Vertical Rails on Wall and Base Cabinets to Divide Double Door Cabinets on 39" Wide and Over.

### Full Overlay Door Styles:

- 1/4" Reveal Around Doors (1/4" of Face Frame Shows).
- Frame Opening + 2 1/2" = Door Size for Base/Wall Cabinets.
- 4 1/2" or 5" High Drawer Opening = 6 1/4" Drawer Front.
- 7 1/2" High Drawer Opening = 10" Drawer Front.
- 8 5/8" and 8 7/8" Drawer Opening = 11 3/8" Drawer Front.

### 1/2" Overlay Door Styles:

- 1" Reveal Around Doors (1" of Face Frame Shows).
- Frame Opening + 1" = Door Size for Base/Wall Cabinets.
- 4 1/2" or 5" High Drawer Opening = 5 1/2" Drawer Front.
- 7 1/2" High Drawer Opening = 8 1/2" Drawer Front.
- 8 5/8" Drawer Opening = 9 7/8" Drawer Front.
- 8 7/8" Drawer Opening = 10 5/8" Drawer Front.

# CABINET DIMENSIONS

## 32 1/2" HIGH UNIVERSAL ACCESS CABINETS, 24" DEEP

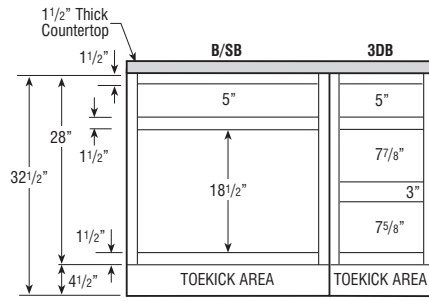

## 32" HIGH UNIVERSAL ACCESS CABINETS, 21" DEEP

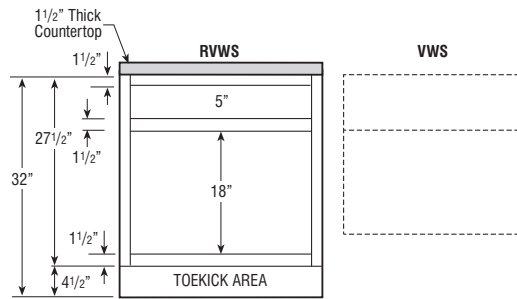

RVWS must be ordered with Vanity Wall Sink (VWS..23), not designed to be a stand-alone unit. See page 342 for more details.

# CABINET DIMENSIONS

## 29" HIGH DESK CABINETS

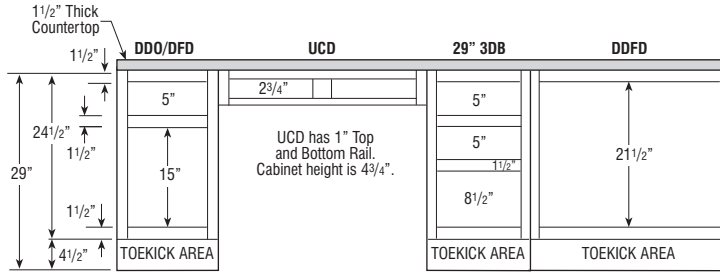

## 32" HIGH VANITY CABINETS

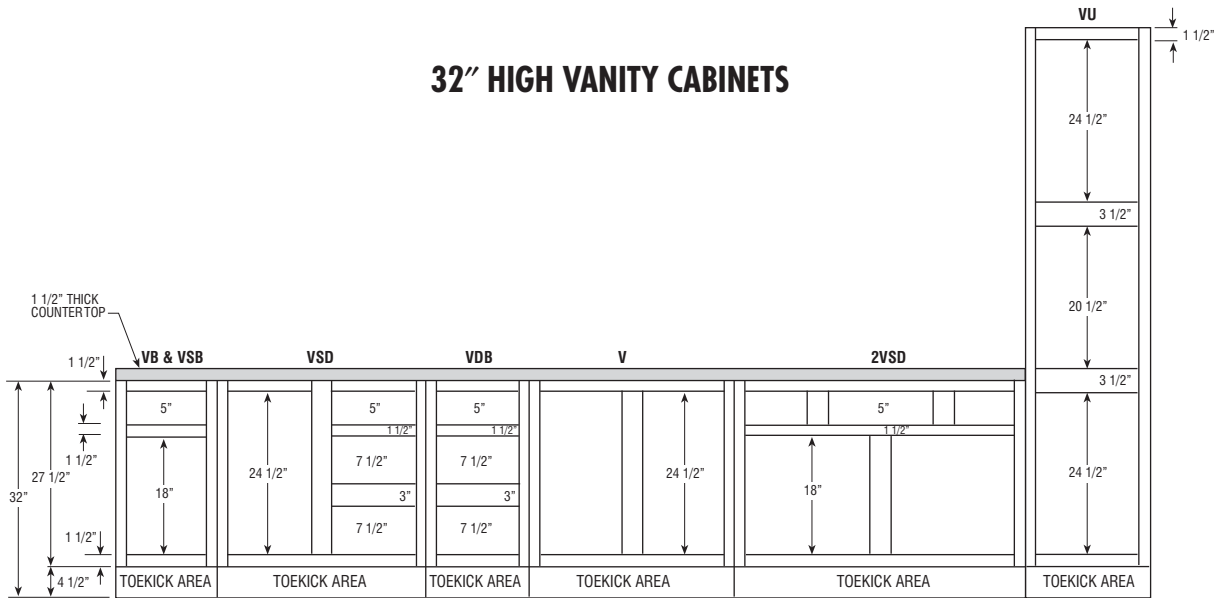

## 34 1/2" HIGH VANITY CABINETS

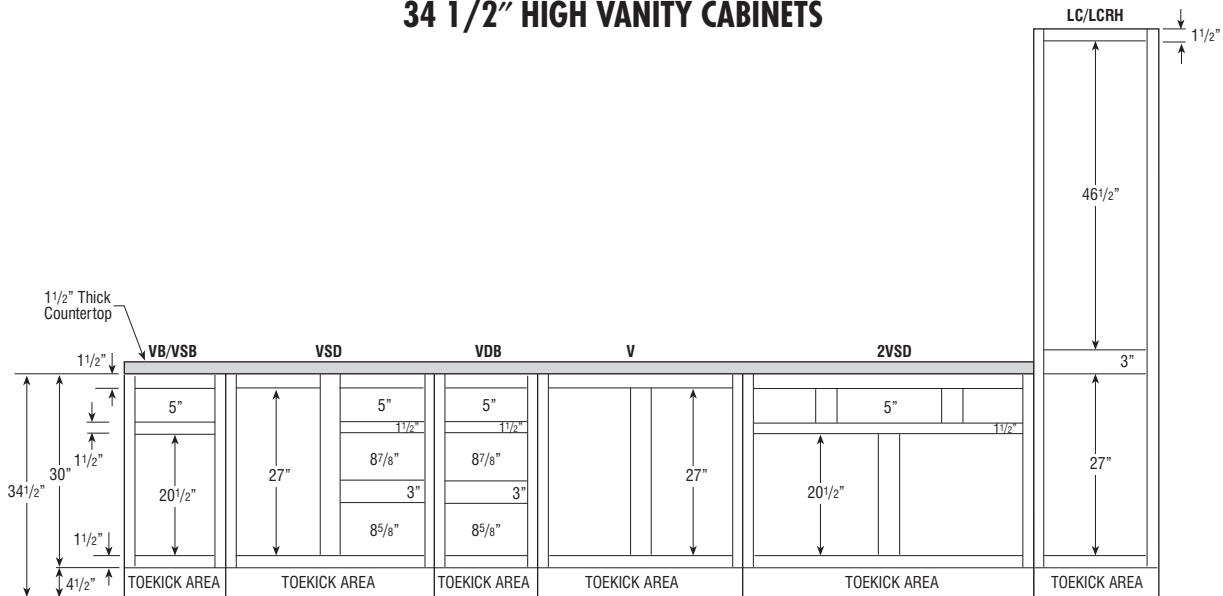

# CABINET DIMENSIONS

## DIMENSIONS FOR CORNER INSTALLATIONS (45° DIAGONAL)

### 12" DEEP CABINETS

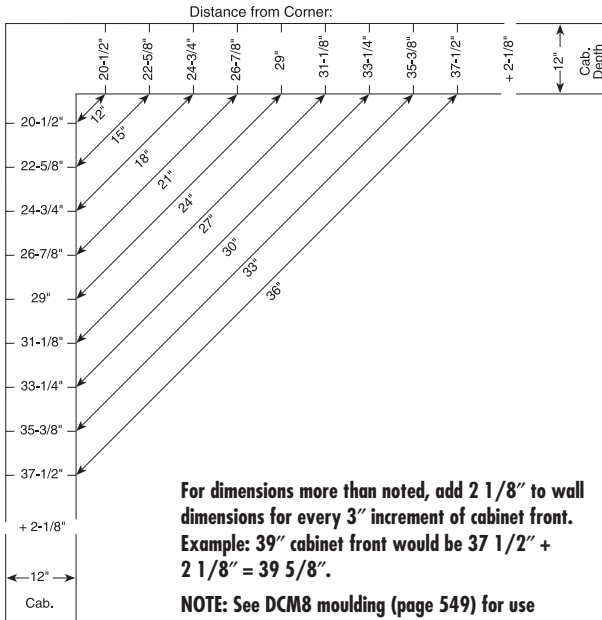

For dimensions more than noted, add 2 1/8" to wall dimensions for every 3" increment of cabinet front.  
 Example: 39" cabinet front would be 37 1/2" + 2 1/8" = 39 5/8".

NOTE: See DCM8 moulding (page 549) for use between cabinets adjacent to 45° corner installations.

### 24" DEEP CABINETS

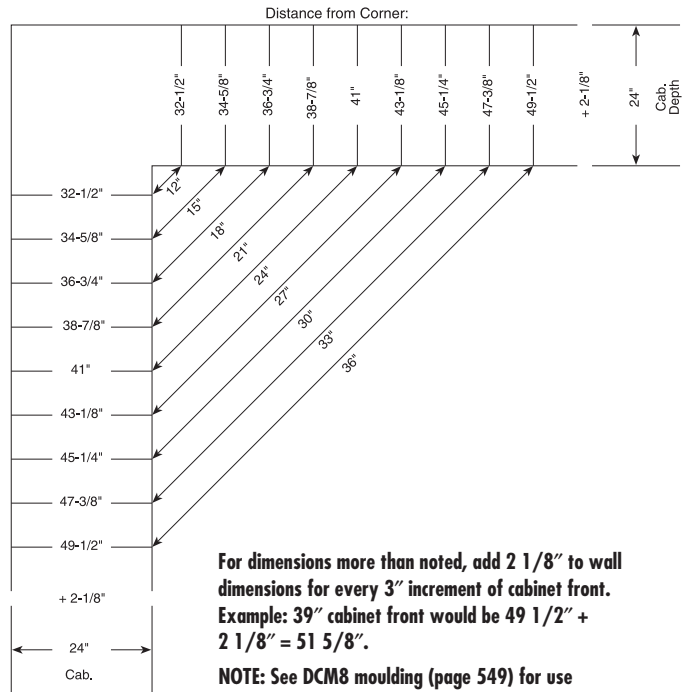

For dimensions more than noted, add 2 1/8" to wall dimensions for every 3" increment of cabinet front.  
 Example: 39" cabinet front would be 49 1/2" + 2 1/8" = 51 5/8".

NOTE: See DCM8 moulding (page 549) for use between cabinets adjacent to 45° corner installations.

## INSTALLATION HEIGHT REQUIREMENTS

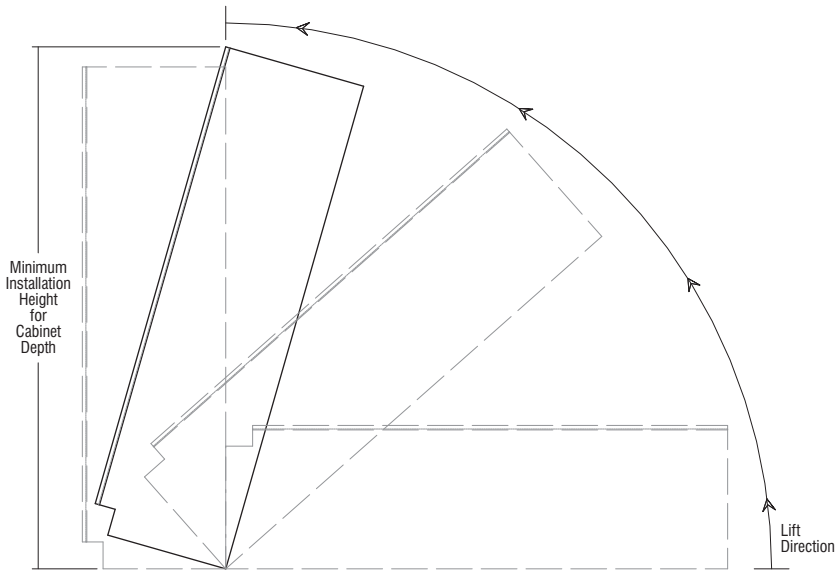

Height of ceiling needs to be considered for installation of tall cabinets. Cabinet height below includes toekick area:

Cabinet Height	Minimum Installation Height for Cabinet Depth					
	12"	15"	18"	21"	24"	27"
84"	84 7/8"	85 11/32"	85 15/16"	86 19/32"	87 3/8"	88 1/4"
87"	87 27/32"	88 5/16"	88 27/32"	89 1/2"	90 1/4"	91 3/32"
90"	90 13/16"	91 1/4"	91 13/16"	92 7/16"	93 5/32"	93 31/32"
93"*	89 5/16"	89 25/32"	90 5/16"	90 31/32"	91 23/32"	92 17/32"
96"*	92 5/16"	92 3/4"	93 9/32"	93 29/32"	94 5/8"	95 13/32"
93" PWT..	—	—	—	95 11/32"	96 1/16"	96 27/32"
96" PWT..	—	—	—	98 9/32"	98 31/32"	99 3/4"

\*Separate pedestal base included with cabinet to be installed after cabinet is in an upright position.

# CABINET DIMENSIONS

## 5-PIECE DRAWER FRONT DIMENSIONS CHART

5-PIECE DRAWER FRONTS	DRAWER FRONT WIDTH	DRAWER FRONT HEIGHT	PANEL FLAT WIDTH	PANEL FLAT HEIGHT
Ainsley	8 1/2"	6 1/4"	3 5/8"	1 3/8"
Asbury	8 1/2"	6 1/4"	3 1/2"	1 1/4"
Banbury	8 1/2"	6 1/4"	3 1/2"	1 1/4"
Brantley	8 1/2"	6 1/4"	3 1/2"	1 1/4"
Campbell	8 1/2"	6 1/4"	3 1/2"	1 1/4"
Carmin DFF5PC	8 1/2"	6 1/4"	3 1/2"	1 1/4"
Chanley DFR5PC	8 1/2"	6 1/4"	1 5/8"	1 1/8"
Denton	8 1/2"	6 1/4"	2 1/2"	1 3/4"
Elston DFF5PC	8 1/2"	6 1/4"	2 1/2"	1 3/4"
Galena DFF5PC	8 1/2"	6 1/4"	3 1/2"	1 1/4"
Herra	8 1/2"	6 1/4"	2 1/2"	1 3/4"
Huxley DFF5PC	8 1/2"	6 1/4"	2 1/2"	1 3/4"
Ingalls DFF5PC	8 1/2"	6 1/4"	4"	1 3/4"
Jarret	8 1/2"	6 1/4"	2 1/2"	1 3/4"
Kayes DFF5PC	8 1/2"	6 1/4"	2 1/2"	1 3/4"
Kennedy	8 1/2"	6 1/4"	3 1/2"	1 1/4"
Morgan DFF5PC	8 1/2"	6 1/4"	2 1/8"	2 1/8"
Parker DFR5PC	8 1/2"	6 1/4"	1 1/4"	1"
Pleasant Hill	8 1/2"	6 1/4"	4"	3 1/4"
Seaton	8 1/2"	6 1/4"	4 1/4"	2"
Whittaker DFF5PC	8 1/2"	6 1/4"	4"	3 1/4"
Willet DFF5PC	8 1/2"	6 1/4"	2 1/2"	1 3/4"

Drawer sizes are representative of a 9" wide base cabinet.



# SCHROCK CABINETRY'S DESIGN CHECKLIST

## CONSTRUCTION OPTIONS

Consider exposed end options:

- Modify exposed cabinet ends to PE or APC.
- Adding a veneer finished end (FB) will age uniformly with the rest of the kitchen.
- Apply 1/4" skin to hide 1/4" reveal. This will allow the ends to age uniformly with the rest of the kitchen and will make it flush.
- Apply decorative door kit (BED, WED, TED). This kit includes 1/4" skin, decorative doors, and screws for field installation.
- Upgrade exposed cabinet ends with Authentic Ends (AUTHL/AUTHR) or Furniture Finished Plywood Ends (FPFB) Modification.

## WOOD AND FINISH CHARACTERISTICS

Review specific details with the customer:

- Mineral Streaks, Birdseye Dots, Grain Variations (especially Rustic Alder and Rustic Hickory).
- Color Variations/Darkening (especially Natural/Light Cherry).
- Finish Variations (Glazes are "consistently inconsistent"), hairline cracks may develop at frame joints on painted frame.
- Underside of cabinets are Natural Maple. Use light rail or cabinet panel edge and skin to hide, especially when designing with peninsula wall cabinets. For cabinets that are bridged between taller adjacent cabinets, specify PFINBTMB modification. See page 49 for more details.

## SMART SOLUTIONS™

Review storage and usage needs with Customer. See chart on pages 86-87 for more Smart Solutions™.

- Cooking Solutions:
  - Wall Spice Rack Cabinet
- Storage Solutions:
  - SuperCabinet™
  - Base Rotating Deep Bin
  - Pegged Dish Organizer
  - Wall Message Center
- Clean-up Center:
  - Trash/Recycle Basket Base

## CLEARANCES

- Add fillers between end cabinets and walls on full overlay door styles.
- Allow space between door/window trim and end cabinets for countertop and top moulding overhang.
- Include refrigerator door hinges in overall refrigerator height when placing cabinets above it.

Maintain a minimum clearance of 3" by pulling blind corners as follows:

- Full Overlay: 1 1/4", Standard Overlay 1/2". (More is needed in certain situations such as when adjacent to an appliance or when using oversized pulls or knobs.)
- Allow sufficient clearance (3") on each side of accessory cabinets (such as roll-out trays, swing-out units, etc.). Doors on these cabinets must open fully for accessories to be functional.
- Ensure the height between the cooktop and range hood is 24" to meet NKBA guidelines.

Qualify customer carefully on upper cabinet/microwave advantages/disadvantages as follows:

- Minimum of 18" from cooktop to upper cabinet/above the range microwave which allows for easy access to either, but less room over back burner.
- Minimum of 21" from cooktop to upper cabinet/microwave which allows for access to large pots on back burner of cooktop, but longer reach to microwave.

## FILLERS

- Place fillers toward end of run where least conspicuous if needed.
- Attach overlay fillers on top of the base, wall, or tall fillers when using full overlay door styles to maintain a consistent reveal. Don't forget to include blind corner fillers.
- Add a filler at least 6" wide to accommodate a decorative onlay when the filler is used as valance.

## VARYING HEIGHTS AND DEPTHS

- Also increase the depth of a wall cabinet run when you increase the height (so moulding on adjacent cabinet will kill into the side of the taller cabinet).
- Skin the sides of tall cabinets to keep adjacent base and wall cabinets out from reveal of tall cabinet.
- Add increased depth on tall end panels for a built-in look for deep refrigerators.
- Account for the additional support needed for wall cabinets with a depth of 18" or greater. This can be achieved by installing a soffit or end panels.

## MATCHING INTERIOR CABINETS/GLASS OPTIONS

- Verify cut-for-glass or mullion door option is available on desired cabinet size. (See pages 62-65 for available cut-for-glass/mullion door sizes.)
- Verify glass insert option is available for desired cut-for-glass door size chosen.
- Verify matching interior option has been selected for all open or glass cabinets.
- Verify mullion door lite grid matches customer expectations.

## MOULDINGS

- Order rosettes and plinths in beaded or fluted styles to match fillers.
- Verify correct amount of crown moulding has been ordered.
- Order toekick caps.
- Order extra scribe.

## ISLANDS AND PENINSULAS

- Consider standard height bars are 34 1/2" tall and require 19" knee space. Raised bars are 42" tall.
- Consider base peninsula cabinets (P) are 24 1/4" deep and require 12" of knee space. Use back panels/doors to flush non-P cabinets with P cabinets.
- Use recess toe on sides and back or BBM8 when using multiple base cabinets to create an island.
- Use outside corner moulding if a skin is exposed on the back of the island.

## APPLIANCES

- Note for all consumers, appliances are not included with any cabinetry product.
- Do not place dishwashers next to diagonal front cabinet (interference) or next to a range (no countertop support).
- Verify refrigerator door has enough clearance to open beyond 90° so refrigerator drawers can be utilized. Refer to appliance manufacturer's specs.
- Add TF696FH, as it may be required to frame around built-in microwave ovens and other built-in items. Refer to appliance manufacturer's specs.
- Order appliance panels.

## SPECIAL CONSIDERATIONS

- Consider V-groove skins and/or decorative doors on exposed cabinet sides in glazed kitchen.

## MISCELLANEOUS

- Order full size touch-up kit (mini touch-up kit included with standard sink base).

## TIPS TO THE INSTALLER

#10 x 2 1/2" installation screws are furnished and packaged inside all cabinets. Proper wall stud or ceiling joist installation is essential for Wall and Peninsula cabinets to support weight. Whenever possible, cabinets should be attached to each other for additional strength. Excessive weight should not be put on cabinets hung by themselves. Shimming may be required to ensure proper alignment. Wallboard alone is not strong enough to support the cabinets.

Our Warranty does not cover damage caused by improper installation. Please be sure to install cabinets properly. If you have questions, please contact your representative or customer service.

## kitchen planning guidelines

### DOOR/ENTRY

- Door opening should be at least 32" wide, requiring a minimum 2' 10" wide door.

### DOOR INTERFERENCE

- Entry door should not interfere with safe appliance operation or appliance doors.

### DISTANCE BETWEEN WORK CENTERS

- With three work centers, the total distance traveled should not be more than 26' with no single leg of the triangle less than 4' or more than 9'.
- With more than three work centers, each additional travel distance to another work center should be no less than 4' or more than 9'. Each leg is measured from the center-front of the appliance/sink. No work triangle leg should intersect an island/peninsula by more than 12".

### SEPARATING WORK CENTERS

- A tall obstacle should not separate two primary work centers. A properly recessed tall corner unit is acceptable.

### WORK TRIANGLE TRAFFIC

- Major traffic patterns should not cross through the basic work triangle.

### WORK AISLE

- The work aisle should be at least 42" for one cook and at least 48" for multiple cooks.

### WALKWAY

- The walkway width should be at least 36".

### TRAFFIC CLEARANCE AT SEATING

- Allow 32" of clearance from the table to wall/obstacle if no traffic passes behind a seated diner. If traffic passes behind the diner, allow at least 36" to edge past or 44" to walk past.

### SEATING CLEARANCE

- 30" high tables/counters should allow a 24" wide by 18" deep space for each seated diner and at least 18" knee space.
- 36" high counters should allow a 24" wide by 15" deep space for each seated diner and at least 15" kneespace.
- 42" high counters should allow a 24" wide by 12" deep space for each seated diner and at least 12" kneespace.

### CLEAN-UP/PREP SINK PLACEMENT

- With only one sink, locate it adjacent to or across from the cooking surface and refrigerator.

### CLEAN-UP/PREP SINK LANDING AREA

- Include at least a 24" wide landing space on one side of the sink and 18" on the other.
- If all the countertop at the sink is not the same height, plan a 24" landing space on one side of the sink and 3" of countertop frontage on the other, both at the same height of the sink.

### PREPARATION/WORK AREA

- Include a section of countertop at least 36" wide x 24" deep next to the sink for a work area.

### DISHWASHER PLACEMENT

- Nearest edge of dishwasher should be within 36" of nearest edge of sink. Provide at least 21" of standing space between the edge of the dishwasher and countertop frontage/appliances/cabinets which are placed at a right angle to the dishwasher.

### WASTE RECEPTACLES

- Include at least 2 waste receptacles, one near the sink and the other nearby for recycling.

### AUXILIARY SINK

- Provide at least 3" of countertop frontage on one side of the auxiliary sink and 18" on the other side, both at the same height as the sink.

### REFRIGERATOR LANDING AREA

- Include at least 15" of landing area on the handle side of the refrigerator, 15" on either side of a side-by-side refrigerator, 15" of landing space which is no more than 48" across from the front of the refrigerator, and 15" above or adjacent to any under-counter style refrigerator.

### COOKING SURFACE LANDING AREA

- Include a minimum of 12" of landing area on one side of the cooking surface and 15" on the other.
- If cooking surface is at a different countertop height than the rest of the kitchen, then the 12" and 15" landing areas must be the same height as the cooking surface.
- For safety reasons, in an island or peninsula situation, the countertop should extend a minimum of 9" behind the cooking surface if the counter height is the same height as the cooking surface.

### COOKING SURFACE CLEARANCE

- Allow 24" between the cooking surface and a protected noncombustible surface above it.
- At least 30" of clearance is required between the cooking surface and an unprotected/combustible surface above it.
- If a microwave/hood combination is used, then the manufacturer's specifications should be followed.

### COOKING SURFACE VENTILATION

- A correctly sized, ducted ventilation system is recommended for all cooking surface appliances. The recommended minimum is 150 CFM.
- Code requires that the manufacturer's specifications be followed. Minimum exhaust rate for a ducted hood is 100 CFM and must be ducted to the outside.
- Make-up air may need to be provided. Refer to local codes.

### COOKING SURFACE SAFETY

- Do not locate cooking surface under an operable window.
- Window treatments above cooking surface should not use flammable materials.
- Place a fire extinguisher near the kitchen exit away from cooking equipment.

### MICROWAVE OVEN PLACEMENT

- The ideal location for the bottom of the microwave is 3" below the principle user's shoulder, but no more than 54" above the floor.

### MICROWAVE LANDING AREA

- Provide at least 15" above, below, or adjacent to the handle side of a microwave oven.

### OVEN LANDING AREA

- Include at least 15" next to or above the oven.
- A 15" landing area that is not more than 48" away is also acceptable as long as the oven does not open into a walkway.

### COMBINING LANDING AREAS

- If two landing areas are adjacent to one another, determine a new minimum for the two by taking the longer of the two and adding 12".

*continued*

## kitchen planning guidelines (continued)

### COUNTERTOP SPACE

- A total of 158" of countertop frontage, 24" deep, with at least 15" clearance above is needed to accommodate all landing, preparation, work, and storage areas.

### COUNTERTOP EDGES

- Clipped or round corners, rather than sharp edges, are recommended on all counters.

### STORAGE

- The recommended total shelf/drawer frontage for a small kitchen (less than 150 square feet) is 1400", for a medium kitchen (151 to 350 square feet) is 1700", and for a large kitchen (greater than 350 square feet) is 2000".

Sizes:	S	M	L
Wall	300"	360"	360"
Base	520"	615"	660"
Drawer	360"	400"	525"
Pantry	180"	230"	310"
Misc.	40"	95"	145"

- The totals for wall, base, drawer, and pantry shelf/drawer frontage can be adjusted upward or downward as long as the recommended total stays the same.

### STORAGE AT CLEAN-UP/PREP SINK

- The recommended total for a small kitchen is 400", a medium kitchen is 480", a large kitchen is 560", and should be located within 72" of the centerline of the main clean-up/prep sink.

### CORNER CABINET STORAGE

- At least one corner cabinet should include a functional storage device.

### ELECTRICAL RECEPTACLES

- GFCI (Ground-Fault-Circuit-Interrupter) protection is required on all receptacles servicing countertop surfaces within the kitchen.

### LIGHTING

- Every work surface should be well illuminated. At least one wall switch-controlled light must be placed at the entrance.
- Window/skylight area, equal to at least 8% of the total square footage of the kitchen, or a total living space which includes a kitchen, is required.

## bathroom planning guidelines

### DOOR/ENTRY

- Doorway opening should be at least 32", requiring a minimum 2' 10" wide door.

### DOOR INTERFERENCE

- The door area should include clear floor space for maneuvering which varies according to the type of door and the direction of the approach.

### CEILING HEIGHT

- Bathroom floor to ceiling minimum height is 80". A shower or tub with a shower head shall have a minimum floor to ceiling height of 80" above a minimum area 30" x 30" at the shower head.

### CLEAR SPACE

- Plan a clear space of 30" from the front edge of all fixtures to any opposite bath fixture, wall, or obstacle.
- A minimum space of at least 21" is required in front of a lavatory, toilet, bidet, and tub, with a 24" minimum space in front of a shower entry.

### SINGLE LAVATORY PLACEMENT

- The distance from the centerline of the lavatory to the sidewall/tall obstacle should be at least 20".
- The minimum distance required is 15". The minimum distance required between a wall and the edge of a lavatory is 4".

### DOUBLE LAVATORY PLACEMENT

- The distance between the centerlines of two lavatories should be at least 36".
- The minimum distance required is 30".
- The minimum distance required between the edges of two lavatories is 4".

### LAVATORY/VANITY HEIGHT

- The height for a lavatory varies from 32" to 43" to fit the user.

### COUNTERTOP EDGES

- Clipped or round corners, rather than sharp edges, are recommended on all counters.

### SHOWER SIZE

- The interior shower size should be at least 36" x 36". The minimum interior shower size required is 30" x 30".

### STORAGE

- Provide adequate, accessible storage for toiletries, bath linens, grooming and general bathroom supplies.
- Storage of frequently used items should be 15" to 48" above floor.

### ELECTRICAL RECEPTACLES

- All GFCI receptacles should be located at electrical appliance points of use.

**Load bearing floors and shelves meet KCMA standards of 15 lbs. per square foot. Warranty does not cover overloading beyond this point.**

To view a complete and updated list of the NKBA Guidelines, visit <https://nkba.org/info/guidelines>

© Copyright 2010 National Kitchen & Bath Association

# SMART SOLUTIONS™ REFERENCE CHART

Wall Cabinets	Description	3"	6"	9"	12"	15"	18"	21"	24"	27"	30"	33"	36"	39"	42"	45"	48"	Page
W18__SPD	Wall Spice Pull-down						•											190
W36__SHLFPD	Wall Shelf Pull-down												•					192
WBCPO___OL	Wall Box Column Pull-outs (Plain, Overlay)	•	•															186
WBCPOKUP3___OL	Wall Box Column Pull-outs w/K-Cup (Plain, Overlay)	•																188
WEAS_____	Wall Easy Access Storage Cabinets					•	•				•		•					128
WMC_____	Wall Message Center	•																204
WSC_____	Wine Storage Cabinet				•	•	•	•	•									200
WSP_____	Wall Spice Pull-outs			•	•													190
WSR_____	Wall Spice Rack Cabinets						•	•										192
<b>Hearths</b>																		
HPP9__21	Hearth Pier w/Pull-out			•														228
<b>Base Cabinets</b>																		
2DB__RT	Two Drawer Bases w/Roll Tray						•	•	•	•	•	•	•					308
2DB36PDO	Two Drawer Base w/Pegged Dish Organizer												•					308
2DB36RTPDO	Two Drawer Base w/Roll Tray & Pegged Dish Organizer												•					308
3DB__WTCD	Three Drawer Bases w/Wood Tiered Cutlery Divider Drawer					•	•	•	•		•		•					312
3DB18KCUP	Three Drawer Base w/Wood Tiered K-Cup Drawer						•											312
3DBDD__	Three Drawer Base Buffet w/Deep Drawer										•	•	•					314
3DBDD__	Three Drawer Bases w/Deep Drawer								•	•	•	•	•					314
4DB__CIW	Four Drawer Bases w/Cutlery Insert Wood Organizer					•	•	•	•									316
4DB__WTCD	Four Drawer Bases w/Wood Tiered Cutlery Divider Drawer					•	•	•	•		•		•					316
4DB18KCUP	Four Drawer Base w/Wood Tiered K-Cup Drawer						•											316
B__CIW	Bases w/Cutlery Insert Wood Organizer					•	•	•	•									236
B__FHMIXSC	Base Cabinets w/Mixer Shelf						•	•	•									270
B__FHRTLO	Bases w/Lid Organizer & Roll Tray										•	•	•					264
B__FSCO	Base w/Food Storage Container Organizer						•		•									266
B__PS	Pots & Pans Organizer Bases w/Drawer								•		•		•					264
B__RTCIW	Bases w/Cutlery Insert Wood Organizer & Roll Tray					•	•	•	•									260
B__RTLO	Bases w/Drawer & Lid Organizer & Roll Tray										•	•	•					264
B__RTWTCD	Bases w/Wood Tiered Cutlery Divider Drawer & Roll Tray					•	•	•	•		•		•					262
B__TDRO	Bases with Roll-out Tray Divider				•	•												270
B__WTCD	Bases w/Wood Tiered Cutlery Divider Drawer					•	•	•	•		•		•					238
B18CWP__	Base w/Can and Wine Bottle Pull-outs						•											268
B18HCWP__	Full Height Base w/Can and Wine Bottle Pull-outs						•											268
B18KCUP	Base w/Wood Tiered K-Cup Drawer						•											240
B18KCUPRT	Base w/Wood Tiered K-Cup Drawer and Roll Trays						•											264
BBCPO___OL	Base Box Column Pull-outs (Plain, Overlay)	•	•															326
BBT24	Base Bin Tray Pull-out										•							320
BBT24FH	Base Bin Tray Pull-out Full Height										•							320
BBT24FHFPD	Base Bin Tray Pull-out Full Height w/Pet Feeding Drawer										•							320
BBT24PFD	Base Bin Tray Pull-out w/Pet Feeding Drawer										•							320
BC__PO	Base Corners w/Pull-out															•	•	292
BCFW__PO	Base Corners Full Width w/Pull-out															•	•	294
BCFW48CPO	Base Corner Full Width w/Curved Pull-out																•	294
BCFW48SP	Base Cabinet Full Width w/Roll Trays & Swing-out																•	294
BCOPP12	Base Container Organizer Pantry Pull-out				•													324
BEAS__	Base Easy Access Storage Cabinets					•	•											246
BMC24	Base Message Center	•																326
BPP__	Base Pantry Pull-outs			•	•													324
BPPP__	Base Pots & Pans Pull-outs									•	•							266
BPT__WB	Base Paper Towel Cabinet w/Wastebasket					•	•											318
BPT__WBFH	Base Paper Towel Cabinet w/Wastebasket Full Height					•	•											318
BRDB36	Base Rotating Deep Bin																•	302
BSC30PR, R, RP, RS, SR	SuperCabinet™											•						248
BSC36PRP, PRS, SRP, SRS	SuperCabinet™												•					252
BSCG__	SuperCabinet™ Gourmet											•	•					250, 254
BDPP12	Base Tray Divider Pantry Pull-out				•													324
BUPP__	Base Utensil Pantry Pull-out			•	•													324
BUPPKB__	Base Utensil Pantry Pull-out w/Knife Block				•	•												326
BV25C30PR, RP, RS, SR	SuperCabinet™ Version 2											•						250
BV25C36PRP, PRS, SRP, SRS	SuperCabinet™ Version 2												•					254
BWB__	Base Wastebaskets					•	•	•										316
BWB__FH	Base Wastebaskets Full Height					•	•	•										318
CNTYSB__CM	Country Sink Base w/CabMat™										•	•	•					288
LSP36	Lazy Susan Pull-out												•					302

• Available widths

continued

# SMART SOLUTIONS™ REFERENCE CHART

Base Cabinets, cont'd	Description	3"	6"	9"	12"	15"	18"	21"	24"	27"	30"	33"	36"	39"	42"	45"	48"	Page
SB__CM, SCM, STCM, STSCM	Sink Base w/CabMat™										•	•	•					272, 276, 280, 282
SB__D	Sink Bases w/Drawers Below								•	•	•	•	•	•	•	•	•	282
SB__S	Sink Base SuperCabinet™										•	•	•					280
SB__STS	Sink Base SuperCabinet™ w/Tilt-out Trays										•	•	•					280
SB36CDY	Sink Base w/Caddy												•					272
SB36SCDY	Sink Base SuperCabinet™ w/Caddy												•					280
SB36STCDY	Sink Base w/Tilt-out Trays & Caddy												•					278
SB36STSCDY	Sink Base SuperCabinet™ w/Tilt-out Trays & Caddy												•					282
SISCR__	Super Lazy Susans w/Chrome Rail												•					300
SISCR____	Asymmetrical Super Lazy Susans w/Chrome Rail												•					302
SSS36	Segmented Super Lazy Susan												•					298
<b>Tall Cabinets</b>																		
PTU____24	Pantry Top Units					•	•	•	•		•	•						372
PTUP__4924	Pantry Top Units w/Pull-out					•	•											374
PY____24	Pantry Units							•					•					378, 380
TPP____24	Tall Pantry Pull-outs			•	•	•	•											374
UOC24__6	Utility Organizer Cabinet		•															366
UOCDZ24__9	Utility Organizer Drop Zone Cabinet								•									368
US21__24	Utility Storage w/Pantry Pull-out							•										376
US21__24PP	Utility Storage w/Pantry Pull-out & Pot and Pan Rack							•										376
<b>Vanity Cabinets</b>																		
LC188421	Linen Closet						•											498
LCRH188421	Linen Closet w/Removable Hamper						•											498
VBH183421	Vanity Hamper w/Drawer						•											498
VBWB153421	Vanity Base Wastebasket					•												472
VGPO123421	Vanity Grooming Pull-out				•													474
VH183221FH	Vanity Hamper						•											496
VMP__32.5	Vanity Mirror w/Side Pull-outs								•		•							506
VP93421	Vanity Pull-out			•														474
VSBB__3421WB	Vanity Sink Bases w/Wastebasket								•		•							460
VSBB30__21U	Vanity Sink Bases w/U-Shaped Roll-out Tray										•							460
VSSB__3421ST	Vanity Sink Base SuperCabinet™ w/Tilt-out Trays										•	•	•					460
VSSB__3421STWB	Vanity Sink Base SuperCabinet™ w/Tilt-out Trays and Wastebasket										•	•	•					460
VWB15__21	Vanity Wastebasket Full Height					•												472, 474
VWB15__21RT	Vanity Wastebasket Full Height w/Roll Tray					•												474
VWH__23.521U	Vanity Wall Hung Double Door w/U-Shaped Pull-outs										•	•						502
<b>Modifications</b>																		
CMAT1 (Base, Universal)	CabMat™										•	•	•					52
CMAT2 (Vanity)	CabMat™								•	•	•	•	•					52
DRWTK	Toekick Drawer						•	•	•	•	•	•	•					59

• Available widths

## WALL CABINET NOMENCLATURE

All Wall Cabinets are 12" deep unless otherwise noted.

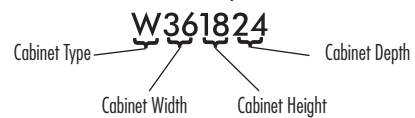

## MODIFICATIONS GRID KEY

- Available
- STD Standard on these cabinets
- S** Smart Solutions™ Organization Cabinet
- 5 DAY** 5 Day Express Response Item

### NEW WALL TOP HINGE, 9" HIGH

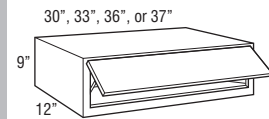

Model	1	2	3	4	5	6
<b>WTH309</b>	449	483	539	629	658	696
<b>WTH339</b>	462	494	556	645	677	715
<b>WTH369</b>	474	504	572	661	695	733
<b>WTH379</b>	479	509	578	668	702	740

- Grain on center panels and slab doors will run horizontally and door rail configuration on non-miter doors will be unique from adjacent cabinet doors. Gallio will have standard vertical grain pattern. Derazi will have standard horizontal grain pattern.
- When ordered in Arch door styles, door will be Square.
- Not available on Whittaker.
- Glass not available.
- Door lift mechanism tension can be field adjusted.
- Depth can be reduced to a minimum of 9".
- Door will open a maximum of 107°. For applications close to a ceiling, door angle can be restricted to 75° with a Wall Top Hinge Restriction Clip (WTHRESCLIP75, see page 590).
- Door will not have standard hinges and may have visible 3/16" diameter holes used during finish processing.
- Lift mechanism not available for order for field installation, only available factory installed.

### NEW WALL TOP HINGE REFRIGERATOR, 9" HIGH, 24" DEEP

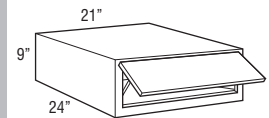

Model	1	2	3	4	5	6
<b>WTH21924</b>	539	580	647	755	790	835

- Utilizes standard doors with vertical grain on center panel and standard door configuration. Gallio will have standard vertical grain pattern. Derazi will have standard horizontal grain pattern.
- 24" deep cabinets must be fully supported by screws installed in a structural member in the ceiling or soffit, and into adjacent cabinets.
- Load limit is 15 lbs. per square foot of load bearing surface.
- Not available on Whittaker.
- Glass not available.
- Two WTH21924 can be used to create a 42" wide solution for wide refrigerator applications.
- Door lift mechanism tension can be field adjusted.
- Depth can be reduced to a minimum of 9".
- Door will open a maximum of 107°. For applications close to a ceiling, door angle can be restricted to 75° with a Wall Top Hinge Restriction Clip (WTHRESCLIP75, see page 590).
- Door will not have standard hinges and may have visible 3/16" diameter holes used during finish processing.
- Lift mechanism not available for order for field installation, only available factory installed.

### NEW WALL TOP HINGE REFRIGERATOR, 9" HIGH, 24" DEEP

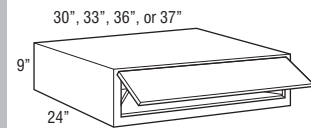

Model	1	2	3	4	5	6
<b>WTH30924</b>	561	604	674	786	823	870
<b>WTH33924</b>	577	617	695	806	846	893
<b>WTH36924</b>	593	630	715	826	869	916
<b>WTH37924</b>	599	636	722	834	878	925

- Grain on center panels and slab doors will run horizontally and door rail configuration on non-miter doors will be unique from adjacent cabinet doors. Gallio will have standard vertical grain pattern. Derazi will have standard horizontal grain pattern.
- When ordered in Arch door styles, door will be Square.
- Not available on Whittaker.
- 24" deep cabinets must be fully supported by screws installed in a structural member in the ceiling or soffit, and into adjacent cabinets.
- Load limit is 15 lbs. per square foot of load bearing surface.
- Glass not available.
- Door lift mechanism tension can be field adjusted.
- Depth can be reduced to a minimum of 9".
- Door will open a maximum of 107°. For applications close to a ceiling, door angle can be restricted to 75° with a Wall Top Hinge Restriction Clip (WTHRESCLIP75, see page 590).
- Door will not have standard hinges and may have visible 3/16" diameter holes used during finish processing.
- Lift mechanism not available for order for field installation, only available factory installed.

## CUSTOM MODIFICATIONS

Mod.	Description	Mod.	Description	Mod.	Description
ADDTK*	Add Toekick	EXL	Extended Stile - Left	MIP	Matching Interior Plywood
AUTHL	Authentic End - Left	EXR	Extended Stile - Right	P	Peninsula
AUTHR	Authentic End - Right	FB	Finished Ends	PFINBTMB	Prepare Cabinet for Finished Bottom
CBO	Cabinet Box Only	FFDL	Face Frame and Door on End - Left	RD	Reduced Depth
CCO	Cabinet Case Only			TD	Tray Dividers
CFNT0	Cabinet Front Only	FFDR	Face Frame and Door on End - Right	TVRAV	Valance Top Rail, Arch
CFRMO	Cabinet Frame Only			TVRFV	Valance Top Rail, Furniture
CND	Cabinet with No Door, with Drawer	FPEB	Furniture Finished Plywood Ends	TVRVV	Valance Top Rail, Straight
EXBKL	End Extended Back - Left	ID	Increased Depth	WLI	White Laminate Interior
EXBKR	End Extended Back - Right	INVFRM	Inverted Frame		

## CONSTRUCTION UPGRADES

Mod.	Description
APC	All-plywood Construction
PE	Plywood Ends

## DOOR OPTIONS

Mod.	Description
ALF	Aluminum Frame Doors
CG, CG.BTM, CG.TOP	Cu-For-glass Doors
DPSRR	Door Panel - Solid Reverse Raised
MD, MD.BTM, MD.TOP	Mullion Doors
MFO	Modified Full Overlay

\*ADDTK available with compatible toekick modifications. See the Modification/Upgrade Compatibility Chart on page 40 for details.

Model	7	8	9	10	11	12	13	14	15	16	17	18
<b>WTH309</b>	694	740	752	782	809	805	839	860	875	902	941	975
<b>WTH339</b>	710	758	774	804	830	826	860	884	898	925	964	1001
<b>WTH369</b>	725	776	795	825	851	847	880	907	921	947	987	1026
<b>WTH379</b>	732	784	803	833	860	855	889	916	930	956	997	1036

### Custom Modifications

ADDTK	AUTHL	AUTHR	CBO	CCO	CFNT0	CFRMO	CND	EXBKL	EXBKR	EXL	EXR	FB	FFDL	FPEB	ID	INVFRM	MIP	P	PFINBTMB	RD	TD	TVRAV	TVRFV	TVRVV	WLI
				•		•		•	•	•				•	•		•		•						•

### Construction Upgrades

APC	PE
•	•

### Door Options

ALF	CG	CG.BTM	CG.TOP	DPSRR	MD	MD.BTM	MD.TOP	MFO
				•				

Model	7	8	9	10	11	12	13	14	15	16	17	18
<b>WTH21924</b>	833	888	902	939	971	966	1007	1032	1050	1083	1129	1170

### Custom Modifications

ADDTK	AUTHL	AUTHR	CBO	CCO	CFNT0	CFRMO	CND	EXBKL	EXBKR	EXL	EXR	FB	FFDL	FPEB	ID	INVFRM	MIP	P	PFINBTMB	RD	TD	TVRAV	TVRFV	TVRVV	WLI
				•		•		•	•	•				•			•		•						•

### Construction Upgrades

APC	PE
•	•

### Door Options

ALF	CG	CG.BTM	CG.TOP	DPSRR	MD	MD.BTM	MD.TOP	MFO
				•				

Model	7	8	9	10	11	12	13	14	15	16	17	18
<b>WTH30924</b>	868	925	940	978	1011	1006	1049	1075	1094	1128	1176	1219
<b>WTH33924</b>	887	948	967	1005	1038	1033	1075	1105	1123	1156	1205	1251
<b>WTH36924</b>	906	970	994	1031	1064	1059	1100	1134	1151	1184	1234	1283
<b>WTH37924</b>	915	980	1004	1041	1075	1070	1111	1145	1163	1196	1246	1296

### Custom Modifications

ADDTK	AUTHL	AUTHR	CBO	CCO	CFNT0	CFRMO	CND	EXBKL	EXBKR	EXL	EXR	FB	FFDL	FPEB	ID	INVFRM	MIP	P	PFINBTMB	RD	TD	TVRAV	TVRFV	TVRVV	WLI
				•		•		•	•	•				•			•		•						•

### Construction Upgrades

APC	PE
•	•

### Door Options

ALF	CG	CG.BTM	CG.TOP	DPSRR	MD	MD.BTM	MD.TOP	MFO
				•				

**WALL SINGLE DOOR, 12" HIGH**

12", 15", 18", 21", or 24"

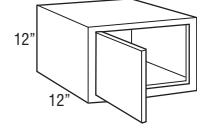

Model	1	2	3	4	5	6
W1212 L or R	295	311	364	425	446	465
W1512 L or R	310	333	388	448	471	493
W1812 L or R	331	352	410	475	501	522
<b>NEW</b> W2112 L or R	347	371	424	496	522	545
<b>NEW</b> W2412 L or R	367	394	442	521	545	574

**WALL TOP HINGE, 12" HIGH**

18" or 21"

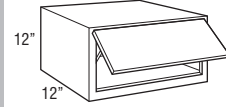

WTH1812	435	468	523	610	637	675
WTH2112	439	473	528	616	643	682

- Utilizes standard doors with vertical grain on center panel and standard door configuration. Gallio will have standard vertical grain pattern. Derazi will have standard horizontal grain pattern.
- Not available on Whittaker.
- Door lift mechanism tension can be field adjusted.
- Depth can be reduced to a minimum of 9".
- Door will open a maximum of 107° due to hinges. For applications close to a ceiling, door angle can be restricted to 86° with a Hinge Angle Restriction Clip (HINGERESCLIP, see page 590).
- Lift mechanisms and mounting brackets will be visible if used with transparent textured glass.
- Lift mechanism not available for order for field installation, only available factory installed.

**WALL DOUBLE DOOR, 12" HIGH**

21", 24", 27", 30", 33", 34", 36", or 37"

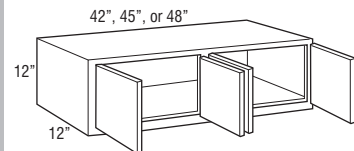
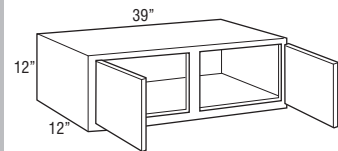
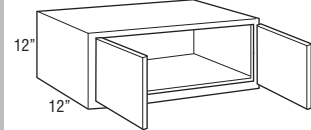

W2112	350	375	428	501	527	551
W2412	371	398	446	526	551	580
W2712	379	405	454	532	556	588
W3012	385	411	461	539	562	597
W3312	394	423	476	554	578	614
W3412	400	427	483	560	586	621
W3612	405	430	488	564	594	628
W3712	411	437	498	575	604	638
W3912	417	446	507	583	614	649
W4212	450	479	541	618	649	685
W4512	496	528	594	680	714	753
W4812	546	581	657	748	785	828

- 42" or wider will feature four doors.

Model	7	8	9	10	11	12	13	14	15	16	17	18
W1212 L or R	467	494	503	525	528	537	561	562	584	602	628	653
W1512 L or R	493	522	532	555	560	570	594	597	619	637	664	691
W1812 L or R	524	555	566	588	594	605	629	632	659	678	706	734
W2112 L or R	545	579	591	615	622	628	671	661	688	708	737	765
W2412 L or R	572	610	623	646	652	655	720	696	726	744	775	806

**Custom Modifications**

ADDTK	AUTHL AUTHR	CBO	CCO	CFNTO	CFRMO	CND	EXBKL EXBKR	EXL EXR	FB	FFDL FFDR	FPEB	ID	INVFRM	MIP	P	PFINBTMB	RD	TD	TVRAV TVRFV TVRVV	WLI
•*	•		•	•	•		•	•	•		•	•		•	•	•	•			•

\*Not available on 21" and 24" wide

**Construction Upgrades**

APC	PE
•	•

**Door Options**

ALF	CG	CG.BTM	CG.TOP	DPSRR	MD	MD.BTM	MD.TOP	MFO
• <sup>1</sup>	•			•				•

<sup>1</sup>Not available on 12", 21", and 24" wide

WTH1812	673	717	729	758	785	780	813	834	848	874	912	945
WTH2112	680	724	736	766	793	788	821	842	856	883	921	954

**Custom Modifications**

ADDTK	AUTHL AUTHR	CBO	CCO	CFNTO	CFRMO	CND	EXBKL EXBKR	EXL EXR	FB	FFDL FFDR	FPEB	ID	INVFRM	MIP	P	PFINBTMB	RD	TD	TVRAV TVRFV TVRVV	WLI
	•		•		•		•	•	•		•	•		•	•	•	•			•

**Construction Upgrades**

APC	PE
•	•

**Door Options**

ALF	CG	CG.BTM	CG.TOP	DPSRR	MD	MD.BTM	MD.TOP	MFO
•				•				•

W2112	551	585	597	621	628	634	678	668	695	715	744	773
W2412	578	616	629	653	659	662	727	703	733	752	783	814
W2712	586	624	637	662	668	677	721	712	742	762	793	824
W3012	593	632	644	669	677	691	716	720	751	771	806	835
W3312	611	650	661	688	696	709	737	739	769	792	826	861
W3412	616	658	670	697	703	717	745	748	780	803	835	869
W3612	620	664	679	706	710	726	755	758	789	811	843	878
W3712	631	676	691	718	722	739	768	771	804	827	861	894

W3912	641	687	702	730	736	752	783	785	818	840	875	912
-------	-----	-----	-----	-----	-----	-----	-----	-----	-----	-----	-----	-----

W4212	680	726	739	766	776	789	823	827	863	883	921	959
W4512	748	797	813	843	852	869	907	910	949	971	1013	1055
W4812	823	878	894	928	936	957	996	1000	1043	1070	1114	1161

**Custom Modifications**

ADDTK	AUTHL AUTHR	CBO	CCO	CFNTO	CFRMO	CND	EXBKL EXBKR	EXL EXR	FB	FFDL FFDR	FPEB	ID	INVFRM	MIP	P	PFINBTMB	RD	TD	TVRAV TVRFV TVRVV	WLI
•	•		•	•	•		•	•	•		•	•		•	•	•	•			•

**Construction Upgrades**

APC	PE
•	•

**Door Options**

ALF	CG	CG.BTM	CG.TOP	DPSRR	MD	MD.BTM	MD.TOP	MFO
•				•				•

**WALL TOP HINGE, 12" HIGH**

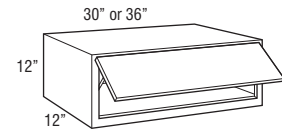

Model	1	2	3	4	5	6
<b>WTH3012</b>	458	493	550	642	671	710
<b>WTH3612</b>	484	514	584	674	709	748

- Utilizes doors from 30" and 36" high wall cabinets. Grain on center panels and slab doors will run horizontally and door rail configuration on non-miter doors will be unique from adjacent cabinet doors. Gallio will have standard vertical grain pattern. Derazi will have standard horizontal grain pattern.
- Not available on Whittaker.
- When ordered in Arch door styles, door will be Square.
- Art Glass not available.
- Cabinet may utilize one or two lift mechanisms depending on door size and weight. Door lift mechanism tension can be field adjusted.
- Depth can be reduced to a minimum of 9".
- Door will open a maximum of 107° due to hinges. For applications close to a ceiling, door angle can be restricted to 86° with a Hinge Angle Restriction Clip (HINGERESCLIP, see page 590).
- Lift mechanisms and mounting brackets will be visible if used with transparent textured glass.
- Lift mechanism not available for order for field installation, only available factory installed.

**WALL REFRIGERATOR SINGLE DOOR, 12" HIGH, 24" DEEP**

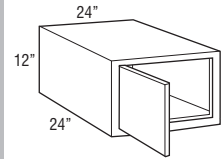

Model	1	2	3	4	5	6
<b>W241224 L or R</b>	447	479	534	631	663	703

- 24" deep cabinets must be fully supported by screws installed in a structural member in the ceiling or soffit, and into adjacent cabinets.
- Load limit is 15 lbs. per square foot of load bearing surface.

**WALL REFRIGERATOR DOUBLE DOOR, 12" HIGH, 24" DEEP**

24", 27", 30", 33", 34", 36", or 37"

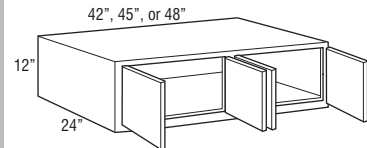
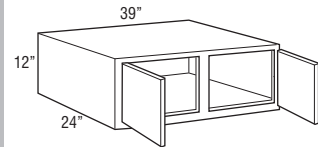
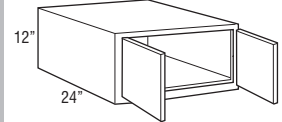

<b>W241224</b>	452	484	539	637	670	710
<b>W271224</b>	469	501	556	654	687	728
<b>W301224</b>	486	518	575	670	706	747
<b>W331224</b>	496	528	589	686	720	761
<b>W341224</b>	500	533	597	693	729	768
<b>W361224</b>	504	537	604	699	737	777
<b>W371224</b>	514	549	616	709	746	789

<b>W391224</b>	525	561	627	718	757	801
----------------	-----	-----	-----	-----	-----	-----

<b>W421224</b>	561	600	663	757	794	841
----------------	-----	-----	-----	-----	-----	-----

<b>W451224</b>	618	661	728	833	874	925
----------------	-----	-----	-----	-----	-----	-----

<b>W481224</b>	680	726	801	915	962	1018
----------------	-----	-----	-----	-----	-----	------

- 24" deep cabinets must be fully supported by screws installed in a structural member in the ceiling or soffit, and into adjacent cabinets.
- Load limit is 15 lbs. per square foot of load bearing surface.
- 42" or wider will feature four doors.

Model	7	8	9	10	11	12	13	14	15	16	17	18
<b>WTH3012</b>	708	755	767	798	826	821	856	878	893	920	960	995
<b>WTH3612</b>	740	792	811	842	868	864	898	925	940	966	1007	1047

**Custom Modifications**

ADDTK	AUTHL AUTHR	CBO	CCO	CFNTO	CFRMO	CND	EXBKL EXBKR	EXL EXR	FB	FFDL FFDR	FPEB	ID	INVFRM	MIP	P	PFINBTMB	RD	TD	TVRAV TVRFV TVRVV	WLI
•	•		•		•		•	•	•		•	•		•		•	•			•

**Construction Upgrades**

APC	PE
•	•

**Door Options**

ALF	CG	CG.BTM	CG.TOP	DPSRR	MD	MD.BTM	MD.TOP	MFO
•	•			•				•

<b>W241224 L or R</b>	694	747	760	793	800	758	831	853	887	911	950	986
-----------------------	-----	-----	-----	-----	-----	-----	-----	-----	-----	-----	-----	-----

**Custom Modifications**

ADDTK	AUTHL AUTHR	CBO	CCO	CFNTO	CFRMO	CND	EXBKL EXBKR	EXL EXR	FB	FFDL FFDR	FPEB	ID	INVFRM	MIP	P	PFINBTMB	RD	TD	TVRAV TVRFV TVRVV	WLI
•	•		•		•		•	•	•		•	•		•		•	•			•

**Construction Upgrades**

APC	PE
•	•

**Door Options**

ALF	CG	CG.BTM	CG.TOP	DPSRR	MD	MD.BTM	MD.TOP	MFO
•	•			•				•

<b>W241224</b>	701	755	768	801	808	766	839	862	896	920	960	996
<b>W271224</b>	719	772	788	820	827	815	869	882	918	943	984	1021
<b>W301224</b>	737	789	807	836	844	865	897	904	937	966	1007	1046
<b>W331224</b>	755	808	824	861	866	880	915	921	961	985	1026	1068
<b>W341224</b>	761	815	831	867	872	889	924	929	969	995	1036	1077
<b>W361224</b>	767	823	837	873	879	897	934	936	976	1006	1046	1087
<b>W371224</b>	779	835	852	886	893	913	949	952	992	1020	1063	1105

<b>W391224</b>	789	845	866	898	909	925	963	966	1008	1036	1080	1122
----------------	-----	-----	-----	-----	-----	-----	-----	-----	------	------	------	------

<b>W421224</b>	832	892	912	949	958	975	1015	1019	1062	1089	1136	1181
----------------	-----	-----	-----	-----	-----	-----	------	------	------	------	------	------

<b>W451224</b>	914	982	1002	1043	1052	1073	1117	1122	1168	1199	1250	1299
----------------	-----	-----	------	------	------	------	------	------	------	------	------	------

<b>W481224</b>	1007	1081	1102	1147	1159	1181	1228	1233	1285	1319	1374	1428
----------------	------	------	------	------	------	------	------	------	------	------	------	------

**Custom Modifications**

ADDTK	AUTHL AUTHR	CBO	CCO	CFNTO	CFRMO	CND	EXBKL EXBKR	EXL EXR	FB	FFDL FFDR	FPEB	ID	INVFRM	MIP	P	PFINBTMB	RD	TD	TVRAV TVRFV TVRVV	WLI
•	•		•		•		•	•	•		•	•		•		•	•			•

**Construction Upgrades**

APC	PE
•	•

**Door Options**

ALF	CG	CG.BTM	CG.TOP	DPSRR	MD	MD.BTM	MD.TOP	MFO
•	•			•				•



**WALL TOP HINGE REFRIGERATOR, 12" HIGH, 24" DEEP**

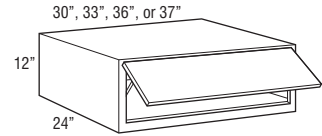

Model	1	2	3	4	5	6
WTH301224	581	619	685	801	842	890
<b>NEW</b> WTH331224	591	630	703	817	861	909
WTH361224	600	641	720	833	879	927
<b>NEW</b> WTH371224	606	647	727	841	888	936

- Grain on center panels and slab doors will run horizontally and door rail configuration on non-miter doors will be unique from adjacent cabinet doors. Gallio will have standard vertical grain pattern. Derazi will have standard horizontal grain pattern.
- Not available on Whittaker.
- When ordered in Arch door styles, door will be Square.
- 24" deep cabinets must be fully supported by screws installed in a structural member in the ceiling or soffit, and into adjacent cabinets.
- Load limit is 15 lbs. per square foot of load bearing surface.
- Art Glass not available.
- Cabinet may utilize one or two lift mechanisms depending on door size and weight. Door lift mechanism tension can be field adjusted.
- Depth can be reduced to a minimum of 9".
- Door will open a maximum of 107° due to hinges. For applications close to a ceiling, door angle can be restricted to 86° with a Hinge Angle Restriction Clip (HINGERESCLIP, see page 590).
- Lift mechanisms and mounting brackets will be visible if used with transparent textured glass.
- Lift mechanism not available for order for field installation, only available factory installed.

**WALL SINGLE DOOR, 15" HIGH**

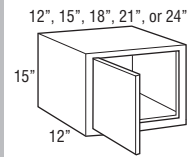

W1215 L or R	310	333	388	448	471	493
W1515 L or R	331	352	410	475	501	522
W1815 L or R	351	375	436	503	530	556
<b>NEW</b> W2115 L or R	373	399	454	525	554	582
<b>NEW</b> W2415 L or R	380	406	463	535	567	594

- Utilizes standard doors with vertical grain on center panel and standard door configuration. Gallio will have standard vertical grain pattern. Derazi will have standard horizontal grain pattern.
- Not available on Whittaker.
- Door lift mechanism tension can be field adjusted.
- Depth can be reduced to a minimum of 9".
- Door will open a maximum of 107° due to hinges. For applications close to a ceiling, door angle can be restricted to 86° with a Hinge Angle Restriction Clip (HINGERESCLIP, see page 590).
- Lift mechanisms and mounting brackets will be visible if used with transparent textured glass.
- Lift mechanism not available for order for field installation, only available factory installed.

**NEW WALL TOP HINGE, 15" HIGH**

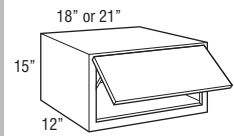

WTH1815	453	482	553	638	671	710
WTH2115	458	487	559	644	678	717

- Utilizes standard doors with vertical grain on center panel and standard door configuration. Gallio will have standard vertical grain pattern. Derazi will have standard horizontal grain pattern.
- Not available on Whittaker.
- Door lift mechanism tension can be field adjusted.
- Depth can be reduced to a minimum of 9".
- Door will open a maximum of 107° due to hinges. For applications close to a ceiling, door angle can be restricted to 86° with a Hinge Angle Restriction Clip (HINGERESCLIP, see page 590).
- Lift mechanisms and mounting brackets will be visible if used with transparent textured glass.
- Lift mechanism not available for order for field installation, only available factory installed.

Model	7	8	9	10	11	12	13	14	15	16	17	18
WTH301224	880	940	962	996	1031	1030	1071	1099	1118	1153	1200	1248
WTH331224	899	961	981	1019	1053	1051	1093	1121	1141	1176	1225	1274
WTH361224	917	982	1000	1041	1074	1071	1114	1142	1164	1199	1249	1299
WTH371224	926	992	1010	1051	1085	1082	1125	1153	1176	1211	1261	1312

**Custom Modifications**

ADDTK	AUTHL AUTHR	CBO	CCO	CFNTO	CFRMO	CND	EXBKL EXBKR	EXL EXR	FB	FFDL FFDR	FPEB	ID	INVFRM	MIP	P	PFINBTMB	RD	TD	TVRAV TVRFV TVRVV	WLI
	•		•		•		•	•	•		•			•		•	•			•

**Construction Upgrades**

APC	PE
•	•

**Door Options**

ALF	CG	CG.BTM	CG.TOP	DPSRR	MD	MD.BTM	MD.TOP	MFO
• <sup>1</sup>	•			•				•

<sup>1</sup>Not available on 33" and 37" wide

W1215 L or R	493	522	532	555	560	570	594	597	619	637	664	691
W1515 L or R	524	555	566	588	594	605	629	632	659	678	706	734
W1815 L or R	553	588	601	621	629	641	667	669	699	718	748	779
W2115 L or R	577	618	632	656	673	673	702	704	735	754	783	815
W2415 L or R	587	630	644	670	687	687	717	720	749	770	800	833

**Custom Modifications**

ADDTK	AUTHL AUTHR	CBO	CCO	CFNTO	CFRMO	CND	EXBKL EXBKR	EXL EXR	FB	FFDL FFDR	FPEB	ID	INVFRM	MIP	P	PFINBTMB	RD	TD	TVRAV TVRFV TVRVV	WLI
•*	•		•	•	•		•	•	•		•	•		•		•	•			•

\*Not available on 21" and 24" wide

**Construction Upgrades**

APC	PE
•	•

**Door Options**

ALF	CG	CG.BTM	CG.TOP	DPSRR	MD	MD.BTM	MD.TOP	MFO
• <sup>1</sup>	•			•				•

<sup>1</sup>Not available on 12", 21", and 24" wide

WTH1815	702	751	769	799	824	837	852	878	892	917	956	994
WTH2115	709	759	777	807	832	845	861	887	901	926	966	1004

**Custom Modifications**

ADDTK	AUTHL AUTHR	CBO	CCO	CFNTO	CFRMO	CND	EXBKL EXBKR	EXL EXR	FB	FFDL FFDR	FPEB	ID	INVFRM	MIP	P	PFINBTMB	RD	TD	TVRAV TVRFV TVRVV	WLI
	•		•		•		•	•	•		•	•		•		•	•			•

**Construction Upgrades**

APC	PE
•	•

**Door Options**

ALF	CG	CG.BTM	CG.TOP	DPSRR	MD	MD.BTM	MD.TOP	MFO
•				•				•

**WALL DOUBLE DOOR, 15" HIGH**

21", 24", 27", 30", 33", 34", 36", or 37"

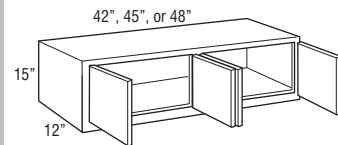
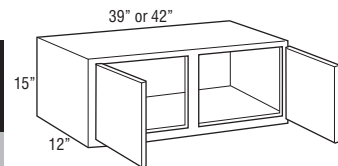
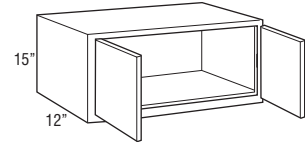

Model	1	2	3	4	5	6
W2115	377	403	459	530	560	588
W2415	384	410	468	540	573	600
W2715	391	418	477	552	583	614
W3015	401	427	487	563	593	627
W3315	411	441	509	593	617	655
W3415	418	448	517	602	628	666
W3615	425	453	525	612	637	676
W3715	436	465	536	624	645	684
W3915	448	476	548	634	655	692
NEW W4215CS	458	488	560	648	670	708
W4215	493	525	602	697	720	761
W4515	531	563	646	750	776	819
W4815	568	602	693	803	828	875

• W4215CS has two doors. W4215 has four doors.

**WALL TOP HINGE, 15" HIGH**

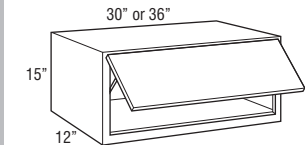

WTH3015	477	507	582	672	706	747
WTH3615	505	541	628	729	760	807

- Utilizes doors from 30" and 36" high wall cabinets. Grain on center panels and slab doors will run horizontally and door rail configuration on non-miter doors will be unique from adjacent cabinet doors. Gallo will have standard vertical grain pattern. Derazi will have standard horizontal grain pattern.
- Not available on Whittaker.
- When ordered in Arch door styles, door will be Square.
- Art Glass not available.
- Cabinet may utilize one or two lift mechanisms depending on door size and weight. Door lift mechanism tension can be field adjusted.
- Depth can be reduced to a minimum of 9".
- Door will open a maximum of 107° due to hinges. For applications close to a ceiling, door angle can be restricted to 86° with a Hinge Angle Restriction Clip (HINGERESCLIP, see page 590).
- Lift mechanisms and mounting brackets will be visible if used with transparent textured glass.
- Lift mechanism not available for order for field installation, only available factory installed.

**NEW WALL REFRIGERATOR SINGLE DOOR, 15" HIGH, 24" DEEP**

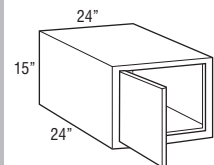

W241524 L or R	467	500	571	657	696	731
----------------	-----	-----	-----	-----	-----	-----

- 24" deep cabinets must be fully supported by screws installed in a structural member in the ceiling or soffit, and into adjacent cabinets.
- Load limit is 15 lbs. per square foot of load bearing surface.

Model	7	8	9	10	11	12	13	14	15	16	17	18
W2115	583	624	638	663	680	680	709	711	742	762	791	823
W2415	593	636	651	677	694	694	724	727	757	778	808	841
W2715	605	649	664	691	708	708	738	742	771	793	823	860
W3015	619	662	678	704	709	721	753	757	788	810	841	875
W3315	653	695	708	736	744	758	788	790	824	847	882	919
W3415	663	706	719	746	755	769	800	803	836	862	895	932
W3615	671	714	730	758	764	782	811	813	847	873	910	944
W3715	684	724	740	768	776	791	822	826	861	885	921	958

W3915	697	734	750	779	785	801	832	836	871	896	932	970
W4215CS	712	751	766	796	818	818	851	856	892	918	954	993

W4215	766	807	824	856	880	880	915	920	959	987	1026	1068
W4515	824	868	886	921	947	947	985	989	1030	1062	1103	1147
W4815	881	928	949	985	1013	1013	1052	1057	1101	1135	1179	1226

**Custom Modifications**

ADDTK	AUTHL AUTHR	CBO	CCO	CFNTO	CFRMO	CND	EXBKL EXBKR	EXL EXR	FB	FFDL FFDR	FPEB	ID	INVRM	MIP	P	PFINBTMB	RD	TD	TVRAV TVRFV TVRVV	WLI
•*	•		•	•	•		•	•	•		•	•		•	•	•	•			•

\*Not available on W4215CS

**Construction Upgrades**

APC	PE
•	•

**Door Options**

ALF	CG	CG.BTM	CG.TOP	DPSRR	MD	MD.BTM	MD.TOP	MFO
•				•				•

WTH3015	739	790	809	841	867	881	897	924	939	965	1006	1046
WTH3615	803	852	869	906	932	954	968	993	1013	1039	1084	1126

**Custom Modifications**

ADDTK	AUTHL AUTHR	CBO	CCO	CFNTO	CFRMO	CND	EXBKL EXBKR	EXL EXR	FB	FFDL FFDR	FPEB	ID	INVRM	MIP	P	PFINBTMB	RD	TD	TVRAV TVRFV TVRVV	WLI
	•		•		•		•	•	•		•	•		•	•	•	•			•

**Construction Upgrades**

APC	PE
•	•

**Door Options**

ALF	CG	CG.BTM	CG.TOP	DPSRR	MD	MD.BTM	MD.TOP	MFO
•	•			•				•

W241524 L or R	724	776	793	825	845	845	880	883	921	948	983	1025
----------------	-----	-----	-----	-----	-----	-----	-----	-----	-----	-----	-----	------

**Custom Modifications**

ADDTK	AUTHL AUTHR	CBO	CCO	CFNTO	CFRMO	CND	EXBKL EXBKR	EXL EXR	FB	FFDL FFDR	FPEB	ID	INVRM	MIP	P	PFINBTMB	RD	TD	TVRAV TVRFV TVRVV	WLI
	•		•	•	•		•	•	•		•	•		•	•	•	•			•

**Construction Upgrades**

APC	PE
•	•

**Door Options**

ALF	CG	CG.BTM	CG.TOP	DPSRR	MD	MD.BTM	MD.TOP	MFO
•				•				•

**WALL REFRIGERATOR DOUBLE DOOR, 15" HIGH, 24" DEEP**

24", 27", 30", 33", 34", 36", or 37"

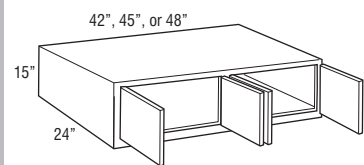
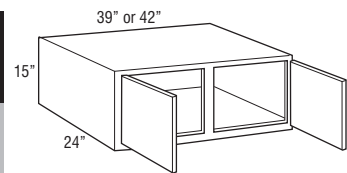
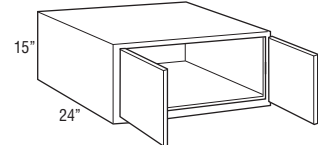

Model	1	2	3	4	5	6
W241524	472	505	577	664	703	738
W271524	477	511	578	664	706	744
W301524	482	515	578	664	707	750
W331524	493	525	604	695	736	776
W341524	504	536	612	702	744	785
W361524	515	548	618	708	752	793
W371524	526	560	632	720	760	803
W391524	534	571	644	733	766	811
<b>NEW</b> W421524CS	551	585	675	783	805	851
W421524	605	643	742	860	885	935
W451524	652	693	796	922	954	1008
W481524	697	742	853	986	1019	1077

- 24" deep cabinets must be fully supported by screws installed in a structural member in the ceiling or soffit, and into adjacent cabinets.
- Load limit is 15 lbs. per square foot of load bearing surface.
- W421524CS has two doors. W421524 has four doors.

**WALL TOP HINGE REFRIGERATOR, 15" HIGH, 24" DEEP**

30", 33", 36", or 37"

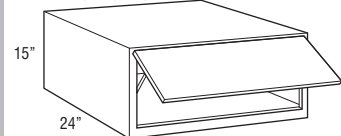

WTH301524	577	614	689	792	843	892
<b>NEW</b> WTH331524	596	633	713	818	870	919
WTH361524	614	652	737	844	896	946
<b>NEW</b> WTH371524	620	659	744	852	905	955

- Grain on center panels and slab doors will run horizontally and door rail configuration on non-miter doors will be unique from adjacent cabinet doors. Gallio will have standard vertical grain pattern. Derazi will have standard horizontal grain pattern.
- Not available on Whittaker.
- When ordered in Arch door styles, door will be Square.
- 24" deep cabinets must be fully supported by screws installed in a structural member in the ceiling or soffit, and into adjacent cabinets.
- Load limit is 15 lbs. per square foot of load bearing surface.
- Art Glass not available.
- Cabinet may utilize one or two lift mechanisms depending on door size and weight. Door lift mechanism tension can be field adjusted.
- Depth can be reduced to a minimum of 9".
- Door will open a maximum of 107° due to hinges. For applications close to a ceiling, door angle can be restricted to 86° with a Hinge Angle Restriction Clip (HINGERESCLIP, see page 590).
- Lift mechanisms and mounting brackets will be visible if used with transparent textured glass.
- Lift mechanism not available for order for field installation, only available factory installed.

**WALL SINGLE DOOR, 18" HIGH**

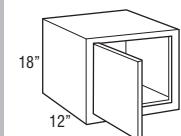

W1218 L or R	339	358	420	484	511	532
W1518 L or R	356	381	445	514	539	564
W1818 L or R	380	403	471	544	575	600
W2118 L or R	400	429	486	569	601	632
W2418 L or R	403	432	490	574	605	636

Model	7	8	9	10	11	12	13	14	15	16	17	18
W241524	731	784	801	833	854	854	889	892	930	958	993	1035
W271524	731	789	806	836	850	861	896	898	935	963	1002	1042
W301524	731	793	809	839	847	867	904	906	939	968	1010	1049
W331524	764	821	836	871	878	896	932	935	975	1001	1043	1085
W341524	771	831	847	882	888	908	944	949	988	1014	1056	1098
W361524	779	839	861	891	898	917	956	961	999	1026	1068	1111
W371524	792	852	869	903	911	928	966	970	1010	1038	1081	1123

W391524	807	863	877	912	920	937	975	980	1019	1049	1092	1136
W421524CS	857	902	924	957	986	986	1024	1030	1070	1105	1148	1195

W421524	942	991	1015	1052	1083	1083	1125	1132	1176	1214	1262	1313
W451524	1014	1066	1091	1132	1165	1165	1211	1216	1266	1305	1357	1413
W481524	1084	1140	1167	1212	1246	1246	1294	1300	1354	1396	1452	1509

**Custom Modifications**

ADDTK	AUTHL AUTHR	CBO	CCO	CFNTO	CFRMO	CND	EXBKL EXBKR	EXL EXR	FB	FFDL FFDR	FPEB	ID	INVFRM	MIP	P	PFINBTMB	RD	TD	TVRAV TVRFV TVRVV	WLI
•*	•		•	•	•		•	•	•		•			•		•	•			•

\*Not available on W421524CS

**Construction Upgrades**

APC	PE
•	•

**Door Options**

ALF	CG	CG.BTM	CG.TOP	DPSRR	MD	MD.BTM	MD.TOP	MFO
	•			•				•

WTH301524	872	946	964	1001	1036	1057	1073	1101	1121	1157	1204	1254
WTH331524	901	974	993	1033	1066	1087	1105	1136	1157	1189	1238	1289
WTH361524	929	1001	1022	1064	1096	1117	1136	1170	1192	1221	1272	1324
WTH371524	938	1011	1032	1075	1107	1128	1147	1182	1204	1233	1285	1337

**Custom Modifications**

ADDTK	AUTHL AUTHR	CBO	CCO	CFNTO	CFRMO	CND	EXBKL EXBKR	EXL EXR	FB	FFDL FFDR	FPEB	ID	INVFRM	MIP	P	PFINBTMB	RD	TD	TVRAV TVRFV TVRVV	WLI
	•		•		•		•	•	•		•			•		•	•			•

**Construction Upgrades**

APC	PE
•	•

**Door Options**

ALF	CG	CG.BTM	CG.TOP	DPSRR	MD	MD.BTM	MD.TOP	MFO
• <sup>1</sup>	•			•				•

<sup>1</sup>Not available on 33" and 37" wide

W1218 L or R	532	564	576	600	604	616	641	644	670	688	716	745
W1518 L or R	564	599	611	634	640	652	679	682	710	729	759	789
W1818 L or R	599	634	649	675	679	693	719	725	755	776	808	839
W2118 L or R	625	669	682	708	715	731	758	763	793	817	849	882
W2418 L or R	631	675	688	714	721	737	764	768	801	822	857	889

**Custom Modifications**

ADDTK	AUTHL AUTHR	CBO	CCO	CFNTO	CFRMO	CND	EXBKL EXBKR	EXL EXR	FB	FFDL FFDR	FPEB	ID	INVFRM	MIP	P	PFINBTMB	RD	TD	TVRAV TVRFV TVRVV	WLI
•	•		•	•	•		•	•	•		•			•		•	•			•

**Construction Upgrades**

APC	PE
•	•

**Door Options**

ALF	CG	CG.BTM	CG.TOP	DPSRR	MD	MD.BTM	MD.TOP	MFO
	•			•	• <sup>1</sup>			•

<sup>1</sup>Not available on 12", 21", and 24" wide

**WALL TOP HINGE, 18" HIGH**

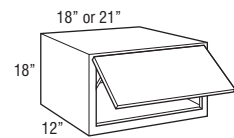

Model	1	2	3	4	5	6
<b>WTH1818</b>	485	521	597	688	719	758
<b>WTH2118</b>	490	526	603	695	726	766

- Utilizes standard doors with vertical grain on center panel and standard door configuration. Gallio will have standard vertical grain pattern. Derazi will have standard horizontal grain pattern.
- Not available on Whittaker.
- Door lift mechanism tension can be field adjusted.
- Depth can be reduced to a minimum of 9".
- Door will open a maximum of 107° due to hinges. For applications close to a ceiling, door angle can be restricted to 86° with a Hinge Angle Restriction Clip (HINGERESCLIP, see page 590).
- Lift mechanisms and mounting brackets will be visible if used with transparent textured glass.
- Lift mechanism not available for order for field installation, only available factory installed.

**WALL DOUBLE DOOR, 18" HIGH**

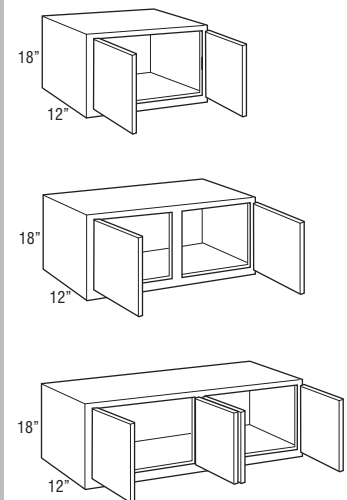

<b>W2418</b>	405	435	494	577	612	640
<b>W2718</b>	417	446	507	589	614	649
<b>W3018</b>	428	459	525	609	633	669
<b>W3318</b>	447	476	552	643	667	708
<b>W3418</b>	452	482	561	651	679	718
<b>W3618</b>	457	487	569	658	691	728
<b>W3718</b>	466	496	582	672	704	743
<b>W3918</b>	474	504	593	686	716	758
<b>W4218</b>	488	521	616	712	748	787
<b>W4518</b>	527	561	664	766	819	846
<b>W4818CS</b>	563	601	710	821	889	907
<b>W4818</b>	637	681	806	930	1030	1023

**WALL TOP HINGE, 18" HIGH**

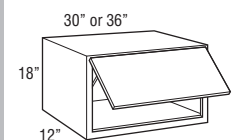

<b>WTH3018</b>	511	548	628	724	757	798
<b>WTH3618</b>	544	582	679	784	821	866

- Utilizes doors from 30" and 36" high wall cabinets. Grain on center panels and slab doors will run horizontally and door rail configuration on non-miter doors will be unique from adjacent cabinet doors. Gallio will have standard vertical grain pattern. Derazi will have standard horizontal grain pattern.
- Not available on Whittaker.
- When ordered in Arch door styles, door will be Square.
- Art Glass not available.
- Cabinet may utilize one or two lift mechanisms depending on door size and weight. Door lift mechanism tension can be field adjusted.
- Depth can be reduced to a minimum of 9".
- Door will open a maximum of 107° due to hinges. For applications close to a ceiling, door angle can be restricted to 86° with a Hinge Angle Restriction Clip (HINGERESCLIP, see page 590).
- Lift mechanisms and mounting brackets will be visible if used with transparent textured glass.
- Lift mechanism not available for order for field installation, only available factory installed.

Model	7	8	9	10	11	12	13	14	15	16	17	18
<b>WTH1818</b>	755	804	820	852	881	896	914	938	956	982	1022	1062
<b>WTH2118</b>	763	812	828	861	890	905	923	947	966	992	1032	1073

**Custom Modifications**

ADDTK	AUTHL AUTHR	CBO	CCO	CFNTD	CFRMO	CND	EXBKL EXBKR	EXL EXR	FB	FFDL FFDR	FPEB	ID	INVFRM	MIP	P	PFINBTMB	RD	TD	TVRAV TVRFV TVRVV	WLI
•	•		•		•		•	•	•	•	•			•		•	•	•	•	•

**Construction Upgrades**

APC	PE
•	•

**Door Options**

ALF	CG	CG.BTM	CG.TOP	DPSRR	MD	MD.BTM	MD.TOP	MFO
•				•				•

<b>W2418</b>	634	679	693	719	727	742	768	776	808	828	864	896
<b>W2718</b>	650	687	702	730	736	752	783	785	818	840	875	912
<b>W3018</b>	668	709	721	753	759	776	807	810	841	867	905	938
<b>W3318</b>	708	751	764	795	804	820	854	857	891	917	957	992
<b>W3418</b>	716	761	776	808	814	831	865	868	905	928	968	1006
<b>W3618</b>	724	769	786	819	826	840	875	878	915	938	980	1018
<b>W3718</b>	739	788	804	837	843	860	893	897	936	960	1000	1039
<b>W3918</b>	755	806	821	855	863	877	912	919	959	980	1019	1060
<b>W4218</b>	785	834	852	883	892	912	949	954	991	1019	1062	1103
<b>W4518</b>	844	896	915	951	961	980	1019	1023	1066	1096	1140	1186
<b>W4818CS</b>	906	961	979	1017	1027	1048	1089	1096	1140	1171	1220	1269

<b>W4818</b>	1024	1085	1105	1150	1161	1183	1228	1237	1289	1324	1378	1432
--------------	------	------	------	------	------	------	------	------	------	------	------	------

**Custom Modifications**

ADDTK	AUTHL AUTHR	CBO	CCO	CFNTD	CFRMO	CND	EXBKL EXBKR	EXL EXR	FB	FFDL FFDR	FPEB	ID	INVFRM	MIP	P	PFINBTMB	RD	TD	TVRAV TVRFV TVRVV	WLI
•	•		•		•		•	•	•	•	•			•		•	•	•*	•	•

\*Not available on 39", 42", 45", and 48" wide

**Construction Upgrades**

APC	PE
•	•

**Door Options**

ALF	CG	CG.BTM	CG.TOP	DPSRR	MD	MD.BTM	MD.TOP	MFO
•				•	†			•

†Available only on 30" and 36" wide

<b>WTH3018</b>	795	846	863	897	927	943	962	987	1006	1034	1076	1118
<b>WTH3618</b>	863	919	936	978	1008	1027	1043	1072	1091	1121	1167	1215

**Custom Modifications**

ADDTK	AUTHL AUTHR	CBO	CCO	CFNTD	CFRMO	CND	EXBKL EXBKR	EXL EXR	FB	FFDL FFDR	FPEB	ID	INVFRM	MIP	P	PFINBTMB	RD	TD	TVRAV TVRFV TVRVV	WLI
•	•		•		•		•	•	•	•	•			•		•	•	•	•	•

**Construction Upgrades**

APC	PE
•	•

**Door Options**

ALF	CG	CG.BTM	CG.TOP	DPSRR	MD	MD.BTM	MD.TOP	MFO
•	•			•				•

**WALL VERTICAL-LIFT, 18" HIGH, 12" DEEP**

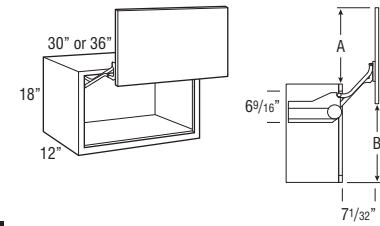

	Full Overlay	Partial Overlay
A	16 13/16"	16 1/16"
B	17 5/16"	18 1/16"

Model	1	2	3	4	5	6
<b>WVL3018</b>	1709	1740	1806	1890	1914	1950
<b>WVL3618</b>	1738	1768	1850	1939	1972	2009

- Utilizes doors from 30" and 36" high wall cabinets. Grain on center panels and slab doors will run horizontally and door rail configuration on non-miter doors will be unique from adjacent cabinet doors. Gallio will have standard vertical grain pattern. Derazi will have standard horizontal grain pattern.
- Decorative hardware required.
- See side view drawing for required clearances.
- Lift mechanism features a single motion for up and out movement with Smart Stop, tension can be field adjusted.
- Lift mechanisms and mounting brackets will be visible if used with transparent textured glass.
- Lift mechanism not available for order for field installation, only available factory installed.
- Hardware extends 1" into opening on each side.
- Art Glass not available.
- Not available on Whittaker.
- When ordered in Arch door styles, door will be Square.

**WALL REFRIGERATOR SINGLE or DOUBLE DOOR, 18" HIGH, 24" DEEP**

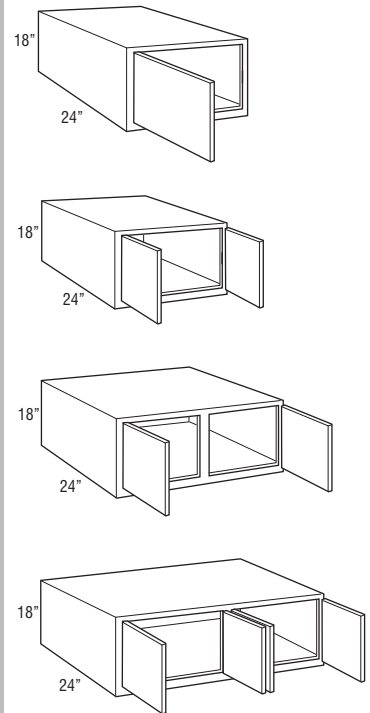

<b>W241824 L or R</b>	496	532	603	704	746	784
<b>W241824</b>	499	534	609	709	751	788
<b>W271824</b>	515	551	613	708	760	800
<b>W301824</b>	531	570	616	706	768	813
<b>W331824</b>	554	589	641	743	807	849
<b>W341824</b>	555	591	651	756	821	865
<b>W361824</b>	555	593	660	766	834	879
<b>W371824</b>	576	614	679	790	865	911
<b>W391824</b>	594	633	697	813	894	940
<b>W421824</b>	634	676	734	857	958	1007
<b>W451824</b>	671	717	782	912	1027	1065
<b>W481824CS</b>	708	757	828	966	1098	1124
<b>W481824</b>	782	836	923	1074	1239	1242

- 24" deep cabinets must be fully supported by screws installed in a structural member in the ceiling or soffit, and into adjacent cabinets.
- Load limit is 15 lbs. per square foot of load bearing surface.

**WALL TOP HINGE REFRIGERATOR, 18" HIGH, 24" DEEP**

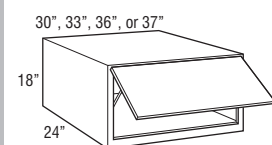

<b>WTH301824</b>	635	680	735	842	917	969
<b>WTH331824</b>	649	693	761	879	955	1009
<b>WTH361824</b>	662	706	787	915	993	1049
<b>WTH371824</b>	675	720	803	933	1013	1070

- Grain on center panels and slab doors will run horizontally and door rail configuration on non-miter doors will be unique from adjacent cabinet doors. Gallio will have standard vertical grain pattern. Derazi will have standard horizontal grain pattern.
- Not available on Whittaker.
- When ordered in Arch door styles, door will be Square.
- 24" deep cabinets must be fully supported by screws installed in a structural member in the ceiling or soffit, and into adjacent cabinets.
- Load limit is 15 lbs. per square foot of load bearing surface.
- Art Glass not available.
- Cabinet may utilize one or two lift mechanisms depending on door size and weight. Door lift mechanism tension can be field adjusted.
- Depth can be reduced to a minimum of 9".
- Door will open a maximum of 107° due to hinges. For applications close to a ceiling, door angle can be restricted to 86° with a Hinge Angle Restriction Clip (HINGERESCLIP, see page 590).
- Lift mechanisms and mounting brackets will be visible if used with transparent textured glass.
- Lift mechanism not available for order for field installation, only available factory installed.

Model	7	8	9	10	11	12	13	14	15	16	17	18
<b>WVL3018</b>	1949	1990	2002	2034	2040	2057	2088	2091	2122	2148	2186	2219
<b>WVL3618</b>	2005	2050	2067	2100	2107	2121	2156	2159	2196	2219	2261	2299

**Custom Modifications**

ADDTK	AUTHL AUTHR	CBO	CCO	CFNTO	CFRMO	CND	EXBKL EXBKR	EXL EXR	FB	FFDL FFDR	FPEB	ID	INVFRM	MIP	P	PFINBTMB	RD	TD	TVRAV TVRFV TVRVV	WLI
	•		•				•	•	•					•						•

**Construction Upgrades**

APC	PE
•	•

**Door Options**

ALF	CG	CG.BTM	CG.TOP	DPSRR	MD	MD.BTM	MD.TOP	MFO
•	•			•				•

<b>W241824 L or R</b>	776	830	846	878	908	908	939	946	985	1013	1053	1095
<b>W241824</b>	780	835	853	884	912	912	946	954	993	1019	1062	1102
<b>W271824</b>	779	849	866	898	917	925	962	968	1009	1035	1078	1120
<b>W301824</b>	777	864	878	913	921	938	976	982	1023	1050	1093	1137
<b>W331824</b>	818	905	920	958	964	985	1023	1029	1071	1099	1144	1190
<b>W341824</b>	831	918	935	973	981	1001	1041	1044	1088	1119	1165	1212
<b>W361824</b>	842	932	951	989	998	1017	1058	1060	1105	1137	1184	1231
<b>W371824</b>	869	966	985	1023	1034	1053	1096	1099	1146	1178	1227	1275
<b>W391824</b>	893	999	1018	1059	1069	1089	1134	1138	1186	1219	1270	1321
<b>W421824</b>	940	1065	1086	1131	1138	1162	1209	1214	1264	1298	1350	1404
<b>W451824</b>	1001	1128	1150	1197	1205	1229	1279	1285	1340	1374	1429	1489
<b>W481824CS</b>	1060	1190	1214	1262	1272	1299	1349	1355	1414	1451	1509	1571
<b>W481824</b>	1179	1315	1341	1394	1405	1436	1492	1499	1562	1602	1668	1736

**Custom Modifications**

ADDTK	AUTHL AUTHR	CBO	CCO	CFNTO	CFRMO	CND	EXBKL EXBKR	EXL EXR	FB	FFDL FFDR	FPEB	ID	INVFRM	MIP	P	PFINBTMB	RD	TD	TVRAV TVRFV TVRVV	WLI
•	•		•				•	•	•					•					•*	•

\*Not available on 39", 42", 45", and 48" wide

**Construction Upgrades**

APC	PE
•	•

**Door Options**

ALF	CG	CG.BTM	CG.TOP	DPSRR	MD	MD.BTM	MD.TOP	MFO
•	•			•	• <sup>1</sup>			•

<sup>1</sup>Available only on 30" and 36" wide

<b>WTH301824</b>	927	1029	1047	1087	1125	1145	1164	1198	1219	1252	1305	1356
<b>WTH331824</b>	967	1071	1091	1133	1172	1194	1213	1247	1269	1304	1359	1413
<b>WTH361824</b>	1007	1113	1134	1178	1218	1242	1262	1296	1319	1356	1413	1470
<b>WTH371824</b>	1027	1135	1157	1202	1242	1267	1287	1322	1345	1383	1441	1499

**Custom Modifications**

ADDTK	AUTHL AUTHR	CBO	CCO	CFNTO	CFRMO	CND	EXBKL EXBKR	EXL EXR	FB	FFDL FFDR	FPEB	ID	INVFRM	MIP	P	PFINBTMB	RD	TD	TVRAV TVRFV TVRVV	WLI
	•		•				•	•	•					•						•

**Construction Upgrades**

APC	PE
•	•

**Door Options**

ALF	CG	CG.BTM	CG.TOP	DPSRR	MD	MD.BTM	MD.TOP	MFO
• <sup>1</sup>	•			•				•

<sup>1</sup>Not available on 33" and 37" wide

**WALL REFRIGERATOR VERTICAL-LIFT, 18" HIGH, 24" DEEP**

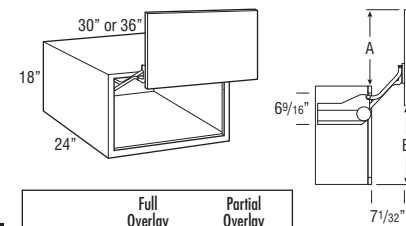

	Full Overlay	Partial Overlay
A	16 13/16"	16 1/16"
B	17 5/16"	18 1/16"

Model	1	2	3	4	5	6
<b>WVL301824</b>	1812	1851	1897	1987	2049	2094
<b>WVL361824</b>	1836	1874	1941	2047	2115	2160

- Utilizes doors from 30" and 36" high wall cabinets. Grain on center panels and slab doors will run horizontally and door rail configuration on non-miter doors will be unique from adjacent cabinet doors. Gallio will have standard vertical grain pattern. Derazi will have standard horizontal grain pattern.
- Decorative hardware required.
- See side view drawing for required clearances.
- Lift mechanism features a single motion for up and out movement with Smart Stop, tension can be field adjusted.
- Lift mechanisms and mounting brackets will be visible if used with transparent textured glass.
- Lift mechanism not available for order for field installation, only available factory installed.
- Hardware extends 1" into opening on each side.
- Art Glass not available.
- Not available on Whittaker.
- When ordered in Arch door styles, door will be Square.
- Depth can be reduced to a minimum of 12".

**WALL REFRIGERATOR PULL-OUT, 18" HIGH, 24" DEEP**

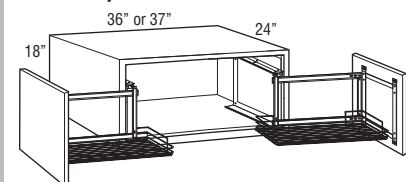

W361824PO L or R  
W371824PO L or R  
W361824PO  
W371824PO

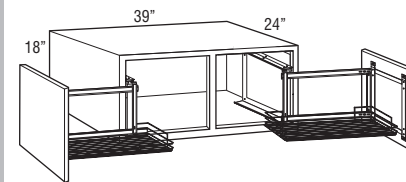

W391824PO L or R  
W391824PO

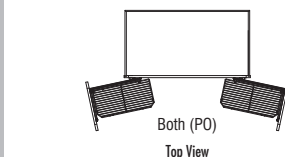
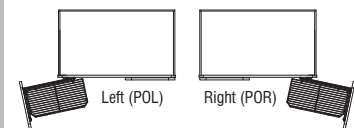

<b>W361824PO L or R</b>	2108	2146	2213	2319	2387	2432
<b>W371824PO L or R</b>	2129	2167	2232	2343	2418	2464
<b>W361824PO</b>	3661	3699	3766	3872	3940	3985
<b>W371824PO</b>	3682	3720	3785	3896	3971	4017

<b>W391824PO L or R</b>	2147	2186	2250	2366	2447	2493
<b>W391824PO</b>	3700	3739	3803	3919	4000	4046

- Door-mounted pull-out with a chrome wire rack that extends fully to the front of the cabinet then opens to the side for easy accessibility to contents. Designed for use above refrigerators or other high applications. Smart Stop not included.
- Available installed in either the left side, right side, or both sides.
- For sufficient pull-out clearance, 13 1/8" of adjacent space is required for door to open fully when installed near a wall or corner.
- Chrome rack is 10" wide and 20 13/16" deep.
- 24" deep cabinets must be fully supported by screws installed in a structural member in the ceiling or soffit, and into adjacent cabinets.
- Load limit is 20 lbs. per pull-out.

**WALL SINGLE DOOR, 21" HIGH**

12", 15", 18", 21", or 24"

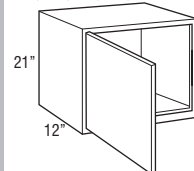

<b>W1221 L or R</b>	353	377	432	485	518	546
<b>W1521 L or R</b>	373	398	456	512	546	575
<b>W1821 L or R</b>	394	417	478	537	575	604
<b>W2121 L or R</b>	412	441	504	568	603	636
<b>W2421 L or R</b>	426	454	519	584	623	658

Model	7	8	9	10	11	12	13	14	15	16	17	18
<b>WVL301824</b>	2058	2145	2159	2194	2202	2219	2257	2263	2304	2331	2374	2418
<b>WVL361824</b>	2123	2213	2232	2270	2279	2298	2339	2341	2386	2418	2465	2512

**Custom Modifications**

ADDTK	AUTHL AUTHR	CBO	CCO	CFNTO	CFRMO	CND	EXBKL EXBKR	EXL EXR	FB	FFDL FFDR	FPEB	ID	INVFRM	MIP	P	PFINBTMB	RD	TD	TVRAV TVRFV TVRVV	WLI
•	•		•				•	•	•		•			•		•	•			•

**Construction Upgrades**

APC	PE
•	•

**Door Options**

ALF	CG	CG.BTM	CG.TOP	DPSRR	MD	MD.BTM	MD.TOP	MFO
•	•			•				•

<b>W361824PO L or R</b>	2395	2485	2504	2542	2551	2570	2611	2613	2658	2690	2737	2784
<b>W371824PO L or R</b>	2422	2519	2538	2576	2587	2606	2649	2652	2699	2731	2780	2828
<b>W361824PO</b>	3948	4038	4057	4095	4104	4123	4164	4166	4211	4243	4290	4337
<b>W371824PO</b>	3975	4072	4091	4129	4140	4159	4202	4205	4252	4284	4333	4381

<b>W391824PO L or R</b>	2446	2552	2571	2612	2622	2642	2687	2691	2739	2772	2823	2874
<b>W391824PO</b>	3999	4105	4124	4165	4175	4195	4240	4244	4292	4325	4376	4427

**Custom Modifications**

ADDTK	AUTHL AUTHR	CBO	CCO	CFNTO	CFRMO	CND	EXBKL EXBKR	EXL EXR	FB	FFDL FFDR	FPEB	ID	INVFRM	MIP	P	PFINBTMB	RD	TD	TVRAV TVRFV TVRVV	WLI
•	•	•					•	•	•		•			•		•	•			•

**Construction Upgrades**

APC	PE
•	•

**Door Options**

ALF	CG	CG.BTM	CG.TOP	DPSRR	MD	MD.BTM	MD.TOP	MFO
				•				•

<b>W1221 L or R</b>	535	579	591	616	619	631	658	661	687	708	737	766
<b>W1521 L or R</b>	564	611	623	646	652	664	691	695	725	744	777	808
<b>W1821 L or R</b>	593	640	657	681	686	700	728	731	762	784	818	849
<b>W2121 L or R</b>	625	676	689	717	724	736	765	768	804	824	862	893
<b>W2421 L or R</b>	643	697	711	739	745	759	789	792	827	852	885	922

**Custom Modifications**

ADDTK	AUTHL AUTHR	CBO	CCO	CFNTO	CFRMO	CND	EXBKL EXBKR	EXL EXR	FB	FFDL FFDR	FPEB	ID	INVFRM	MIP	P	PFINBTMB	RD	TD	TVRAV TVRFV TVRVV	WLI
•	•		•				•	•	•		•			•		•	•			•

**Construction Upgrades**

APC	PE
•	•

**Door Options**

ALF	CG	CG.BTM	CG.TOP	DPSRR	MD	MD.BTM	MD.TOP	MFO
	•			•				•

**WALL TOP HINGE, 21" HIGH**

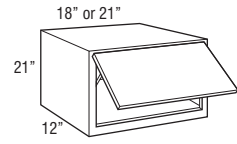

Model	1	2	3	4	5	6
<b>WTH1821</b>	758	791	878	960	1009	1053
<b>WTH2121</b>	766	799	887	970	1019	1064

- Utilizes standard doors with vertical grain on center panel and standard door configuration. Gallio will have standard vertical grain pattern. Derazi will have standard horizontal grain pattern.
- Not available on Whittaker.
- Door lift mechanism tension can be field adjusted.
- Depth can be reduced to a minimum of 9".
- Door will open a maximum of 107° due to hinges. For applications close to a ceiling, door angle can be restricted to 86° with a Hinge Angle Restriction Clip (HINGERESCLIP, see page 590).
- Lift mechanisms and mounting brackets will be visible if used with transparent textured glass.
- Lift mechanism not available for order for field installation, only available factory installed.

Model	7	8	9	10	11	12	13	14	15	16	17	18
<b>WTH1821</b>	1035	1104	1119	1156	1162	1184	1222	1269	1269	1298	1342	1386
<b>WTH2121</b>	1045	1115	1130	1168	1174	1196	1234	1282	1282	1311	1355	1400

**Custom Modifications**

ADDTK	AUTHL AUTHR	CBO	CCO	CFNTO	CFRMO	CND	EXBKL EXBKR	EXL EXR	FB	FFDL FFDR	FPEB	ID	INVFRM	MIP	P	PFINBTMB	RD	TD	TVRAV TVRFV TVRVV	WLI	
•	•		•				•	•	•	•	•			•					•	•	•

**Construction Upgrades**

APC	PE
•	•

**Door Options**

ALF	CG	CG.BTM	CG.TOP	DPSRR	MD	MD.BTM	MD.TOP	MFO
•				•				•

<b>W2421</b>	671	727	740	769	777	790	822	826	863	885	923	961
<b>W2721</b>	692	750	763	793	801	815	846	853	888	914	951	989
<b>W3021</b>	720	780	794	827	833	849	882	886	925	951	990	1031
<b>W3321</b>	764	810	827	863	868	882	918	924	963	987	1029	1071
<b>W3421</b>	785	826	843	878	884	898	936	943	981	1007	1048	1090
<b>W3621</b>	806	839	861	891	898	917	956	961	999	1026	1068	1111
<b>W3721</b>	820	859	877	912	918	936	973	979	1019	1047	1089	1133

<b>W3921</b>	833	875	892	930	936	957	992	998	1040	1066	1112	1157
<b>W4221</b>	867	912	929	967	975	992	1034	1039	1082	1110	1157	1202
<b>W4521</b>	921	969	988	1027	1037	1055	1098	1105	1150	1179	1227	1277
<b>W4821CS</b>	975	1026	1046	1087	1098	1117	1163	1169	1217	1249	1300	1351

<b>W4821</b>	1083	1139	1162	1209	1219	1242	1291	1299	1351	1387	1446	1503
--------------	------	------	------	------	------	------	------	------	------	------	------	------

**Custom Modifications**

ADDTK	AUTHL AUTHR	CBO	CCO	CFNTO	CFRMO	CND	EXBKL EXBKR	EXL EXR	FB	FFDL FFDR	FPEB	ID	INVFRM	MIP	P	PFINBTMB	RD	TD	TVRAV TVRFV TVRVV	WLI	
•	•		•				•	•	•	•	•			•					•	•*	•

\*Not available on 39", 42", 45", and 48" wide

**Construction Upgrades**

APC	PE
•	•

**Door Options**

ALF	CG	CG.BTM	CG.TOP	DPSRR	MD	MD.BTM	MD.TOP	MFO
•				•				•

<b>WTH3021</b>	1089	1162	1178	1217	1223	1246	1286	1336	1336	1366	1413	1459
<b>WTH3621</b>	1189	1232	1254	1296	1303	1324	1368	1423	1423	1453	1504	1554

**Custom Modifications**

ADDTK	AUTHL AUTHR	CBO	CCO	CFNTO	CFRMO	CND	EXBKL EXBKR	EXL EXR	FB	FFDL FFDR	FPEB	ID	INVFRM	MIP	P	PFINBTMB	RD	TD	TVRAV TVRFV TVRVV	WLI	
	•		•				•	•	•		•			•					•	•	•

**Construction Upgrades**

APC	PE
•	•

**Door Options**

ALF	CG	CG.BTM	CG.TOP	DPSRR	MD	MD.BTM	MD.TOP	MFO
•	•			•				•

**WALL DOUBLE DOOR, 21" HIGH**

24", 27", 30", 33", 34", 36", or 37"

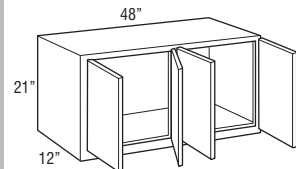
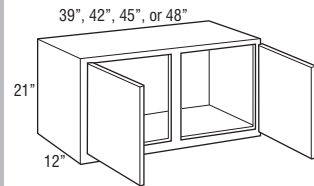
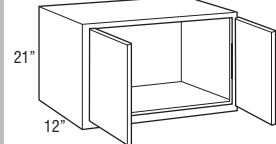

<b>W2421</b>	445	472	541	611	649	684
<b>W2721</b>	458	486	557	629	669	706
<b>W3021</b>	476	506	581	655	697	735
<b>W3321</b>	488	521	610	695	726	763
<b>W3421</b>	496	528	621	714	739	779
<b>W3621</b>	503	534	633	731	752	793
<b>W3721</b>	514	548	645	744	769	810

<b>W3921</b>	525	561	660	758	786	826
<b>W4221</b>	546	583	685	788	818	861
<b>W4521</b>	581	619	728	838	870	914
<b>W4821CS</b>	615	657	771	886	921	967

<b>W4821</b>	681	729	857	986	1022	1075
--------------	-----	-----	-----	-----	------	------

**WALL TOP HINGE, 21" HIGH**

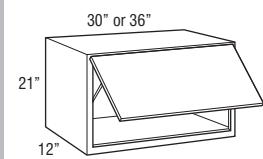

<b>WTH3021</b>	798	833	924	1011	1062	1108
<b>WTH3621</b>	831	871	988	1101	1128	1176

- Utilizes doors from 30" and 36" high wall cabinets. Grain on center panels and slab doors will run horizontally and door rail configuration on non-miter doors will be unique from adjacent cabinet doors. Gallio will have standard vertical grain pattern. Derazi will have standard horizontal grain pattern.
- Not available on Whittaker.
- When ordered in Arch door styles, door will be Square.
- Art Glass not available.
- Cabinet may utilize one or two lift mechanisms depending on door size and weight. Door lift mechanism tension can be field adjusted.
- Depth can be reduced to a minimum of 9".
- Door will open a maximum of 107° due to hinges. For applications close to a ceiling, door angle can be restricted to 86° with a Hinge Angle Restriction Clip (HINGERESCLIP, see page 590).
- Lift mechanisms and mounting brackets will be visible if used with transparent textured glass.
- Lift mechanism not available for order for field installation, only available factory installed.

**WALL VERTICAL-LIFT, 21" HIGH, 12" DEEP**

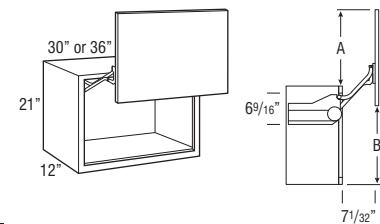

	Full Overlay	Partial Overlay
A	16 13/16"	16 1/16"
B	17 5/16"	18 1/16"

Model	1	2	3	4	5	6
WVL3021	1757	1787	1862	1936	1978	2016
WVL3621	1784	1815	1914	2012	2033	2074

- Utilizes doors from 30" and 36" high wall cabinets. Grain on center panels and slab doors will run horizontally and door rail configuration on non-miter doors will be unique from adjacent cabinet doors. Gallio will have standard vertical grain pattern. Derazi will have standard horizontal grain pattern.
- Decorative hardware required.
- See side view drawing for required clearances.
- Lift mechanism features a single motion for up and out movement with Smart Stop, tension can be field adjusted.
- Lift mechanisms and mounting brackets will be visible if used with transparent textured glass.
- Lift mechanism not available for order for field installation, only available factory installed.
- Hardware extends 1" into opening on each side.
- Art Glass not available.
- Not available on Whittaker.
- When ordered in Arch door styles, door will be Square.

**WALL REFRIGERATOR SINGLE or DOUBLE DOOR, 21" HIGH, 24" DEEP**

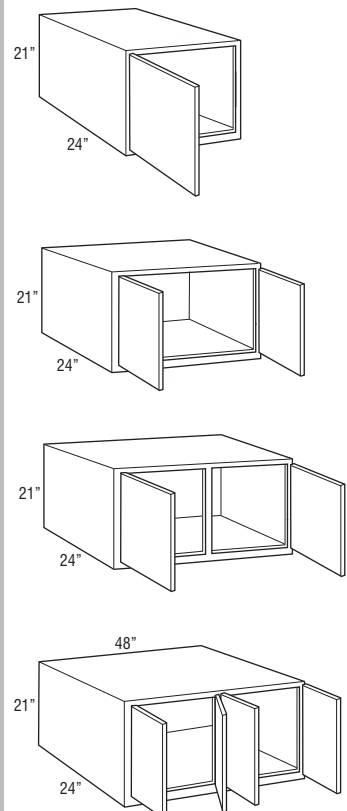

Model	1	2	3	4	5	6
W242124 L or R	525	557	638	718	765	809
W242124	546	581	667	750	797	841
W272124	564	598	672	762	815	863
W302124	581	617	677	773	833	883
W332124	598	634	700	803	864	910
W342124	600	637	714	822	881	928
W362124	601	640	727	840	896	946
W372124	613	654	741	860	916	964
W392124	624	666	756	877	934	981
W422124	672	717	842	969	1007	1057
W452124	715	762	895	1031	1070	1124
W482124CS	756	808	949	1091	1133	1190
W482124	837	896	1053	1213	1258	1322

- 24" deep cabinets must be fully supported by screws installed in a structural member in the ceiling or soffit, and into adjacent cabinets.
- Load limit is 15 lbs. per square foot of load bearing surface.

**WALL TOP HINGE REFRIGERATOR, 21" HIGH, 24" DEEP**

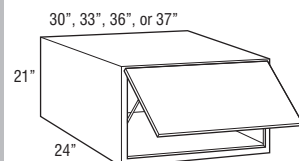

WTH302124	924	967	1039	1153	1223	1287
WTH332124	936	981	1068	1194	1262	1324
WTH362124	947	994	1096	1235	1300	1361
WTH372124	966	1014	1118	1260	1326	1388

- Utilizes doors from 30" and 36" high wall cabinets. Grain on center panels and slab doors will run horizontally and door rail configuration on non-miter doors will be unique from adjacent cabinet doors. Gallio will have standard vertical grain pattern. Derazi will have standard horizontal grain pattern.
- Not available on Whittaker.
- When ordered in Arch door styles, door will be Square.
- 24" deep cabinets must be fully supported by screws installed in a structural member in the ceiling or soffit, and into adjacent cabinets.
- Load limit is 15 lbs. per square foot of load bearing surface.
- Art Glass not available.
- Cabinet may utilize one or two lift mechanisms depending on door size and weight. Door lift mechanism tension can be field adjusted.
- Depth can be reduced to a minimum of 9".
- Door will open a maximum of 107° due to hinges. For applications close to a ceiling, door angle can be restricted to 86° with a Hinge Angle Restriction Clip (HINGERESCLIP, see page 590).
- Lift mechanisms and mounting brackets will be visible if used with transparent textured glass.
- Lift mechanism not available for order for field installation, only available factory installed.

Model	7	8	9	10	11	12	13	14	15	16	17	18
WVL3021	2001	2061	2075	2108	2114	2130	2163	2167	2206	2232	2271	2312
WVL3621	2087	2120	2142	2172	2179	2198	2237	2242	2280	2307	2349	2392

**Custom Modifications**

ADDTK	AUTHL AUTHR	CBO	CCO	CFNTD	CFRMO	CND	EXBKL EXBKR	EXL EXR	FB	FFDL FFDR	FPEB	ID	INVRM	MIP	P	PFINBTMB	RD	TD	TVRAV TVRFV TVRVV	WLI
	•		•				•	•	•					•						•

**Construction Upgrades**

APC	PE
•	•

**Door Options**

ALF	CG	CG.BTM	CG.TOP	DPSRR	MD	MD.BTM	MD.TOP	MFO
•	•			•				•

Model	792	860	874	910	933	933	970	975	1017	1047	1089	1134
W242124 L or R	792	860	874	910	933	933	970	975	1017	1047	1089	1134
W242124	824	892	911	947	971	971	1013	1016	1059	1089	1136	1181
W272124	838	916	934	970	988	998	1038	1042	1086	1117	1164	1211
W302124	853	937	958	993	1005	1023	1063	1069	1114	1142	1190	1239
W332124	881	963	984	1020	1030	1051	1092	1097	1142	1174	1223	1272
W342124	904	982	1002	1041	1051	1072	1115	1119	1166	1199	1249	1299
W362124	924	1001	1020	1062	1072	1092	1136	1140	1188	1222	1273	1325
W372124	945	1020	1040	1082	1092	1115	1160	1163	1212	1247	1299	1351
W392124	965	1039	1060	1101	1113	1135	1181	1184	1233	1270	1324	1377
W422124	1065	1121	1142	1189	1220	1220	1270	1278	1330	1366	1422	1478
W452124	1132	1192	1215	1263	1298	1298	1350	1359	1415	1451	1512	1572
W482124CS	1199	1262	1286	1338	1374	1374	1429	1438	1497	1537	1600	1664
W482124	1331	1401	1428	1487	1525	1525	1589	1598	1664	1705	1777	1849

**Custom Modifications**

ADDTK	AUTHL AUTHR	CBO	CCO	CFNTD	CFRMO	CND	EXBKL EXBKR	EXL EXR	FB	FFDL FFDR	FPEB	ID	INVRM	MIP	P	PFINBTMB	RD	TD	TVRAV TVRFV TVRVV	WLI
•	•		•				•	•	•	•	•			•					•*	•

\*Not available on 39", 42", 45", and 48" wide

**Construction Upgrades**

APC	PE
•	•

**Door Options**

ALF	CG	CG.BTM	CG.TOP	DPSRR	MD	MD.BTM	MD.TOP	MFO
•	•			•				•

Model	1245	1349	1372	1418	1428	1451	1501	1559	1559	1596	1651	1709
WTH302124	1245	1349	1372	1418	1428	1451	1501	1559	1559	1596	1651	1709
WTH332124	1290	1388	1411	1459	1469	1494	1545	1604	1604	1642	1700	1759
WTH362124	1335	1426	1450	1500	1509	1537	1588	1649	1649	1687	1749	1808
WTH372124	1362	1455	1479	1530	1539	1568	1620	1682	1682	1721	1784	1844

**Custom Modifications**

ADDTK	AUTHL AUTHR	CBO	CCO	CFNTD	CFRMO	CND	EXBKL EXBKR	EXL EXR	FB	FFDL FFDR	FPEB	ID	INVRM	MIP	P	PFINBTMB	RD	TD	TVRAV TVRFV TVRVV	WLI
	•		•				•	•	•					•						•

**Construction Upgrades**

APC	PE
•	•

**Door Options**

ALF	CG	CG.BTM	CG.TOP	DPSRR	MD	MD.BTM	MD.TOP	MFO
•†	•			•				•

†Not available on 33" and 37" wide



**WALL REFRIGERATOR VERTICAL-LIFT, 21" HIGH, 24" DEEP**

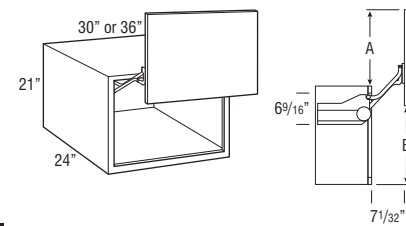

	Full Overlay	Partial Overlay
A	16 13/16"	16 1/16"
B	17 5/16"	18 1/16"

Model	1	2	3	4	5	6
<b>WVL302124</b>	1862	1898	1958	2054	2114	2164
<b>WVL362124</b>	1882	1921	2008	2121	2177	2227

- Utilizes doors from 30" and 36" high wall cabinets. Grain on center panels and slab doors will run horizontally and door rail configuration on non-miter doors will be unique from adjacent cabinet doors. Gallio will have standard vertical grain pattern. Derazi will have standard horizontal grain pattern.
- Decorative hardware required.
- See side view drawing for required clearances.
- Lift mechanism features a single motion for up and out movement with Smart Stop, tension can be field adjusted.
- Lift mechanisms and mounting brackets will be visible if used with transparent textured glass.
- Lift mechanism not available for order for field installation, only available factory installed.
- Hardware extends 1" into opening on each side.
- Art Glass not available.
- Not available on Whittaker.
- When ordered in Arch door styles, door will be Square.
- Depth can be reduced to a minimum of 12".

**WALL REFRIGERATOR PULL-OUT, 21" HIGH, 24" DEEP**

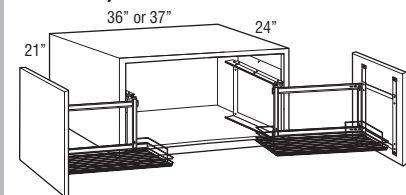

W362124PO L or R  
W372124PO L or R  
W362124PO  
W372124PO

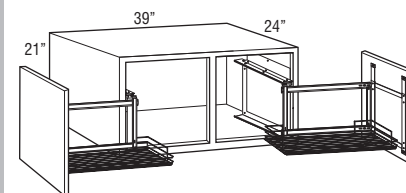

W392124PO L or R  
W392124PO

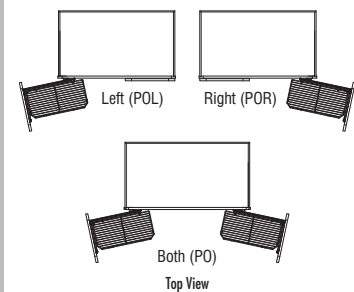

<b>W362124PO L or R</b>	2154	2193	2280	2393	2449	2499
<b>W372124PO L or R</b>	2166	2207	2294	2413	2469	2517
<b>W362124PO</b>	3707	3746	3833	3946	4002	4052
<b>W372124PO</b>	3719	3760	3847	3966	4022	4070

<b>W392124PO L or R</b>	2177	2219	2309	2430	2487	2534
<b>W392124PO</b>	3730	3772	3862	3983	4040	4087

- Door-mounted pull-out with a chrome wire rack that extends fully to the front of the cabinet then opens to the side for easy accessibility to contents. Designed for use above refrigerators or other high applications. Smart Stop not included.
- Available installed in either the left side, right side, or both sides.
- For sufficient pull-out clearance, 13 1/8" of adjacent space is required for door to open fully when installed near a wall or corner.
- Chrome rack is 10" wide and 20 13/16" deep.
- 24" deep cabinets must be fully supported by screws installed in a structural member in the ceiling or soffit, and into adjacent cabinets.
- Load limit is 20 lbs. per pull-out.

**WALL SINGLE DOOR, 24" HIGH**

12", 15", 18", 21", or 24"

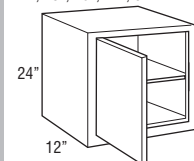

<b>W1224 L or R</b>	310	331	390	430	438	461
<b>W1524 L or R</b>	317	339	400	440	448	471
<b>W1824 L or R</b>	337	357	423	464	475	498
<b>W2124 L or R</b>	366	395	465	511	522	548
<b>W2424 L or R</b>	375	403	473	518	530	556

Model	7	8	9	10	11	12	13	14	15	16	17	18
<b>WVL302124</b>	2134	2218	2239	2274	2286	2304	2344	2350	2395	2423	2471	2520
<b>WVL362124</b>	2205	2282	2301	2343	2353	2373	2417	2421	2469	2503	2554	2606

**Custom Modifications**

ADDTK	AUTHL AUTHR	CBO	CCO	CFNTO	CFRMO	CND	EXBKL EXBKR	EXL EXR	FB	FFDL FFDR	FPEB	ID	INVRM	MIP	P	PFINBTMB	RD	TD	TVRAV TVRFV TVRVV	WLI
•	•	•	•	•	•	•	•	•	•	•	•	•	•	•	•	•	•	•	•	•

**Construction Upgrades**

APC	PE
•	•

**Door Options**

ALF	CG	CG.BTM	CG.TOP	DPSRR	MD	MD.BTM	MD.TOP	MFO
•	•	•	•	•	•	•	•	•

<b>W362124PO L or R</b>	2477	2554	2573	2615	2625	2645	2689	2693	2741	2775	2826	2878
<b>W372124PO L or R</b>	2498	2573	2593	2635	2645	2668	2713	2716	2765	2800	2852	2904
<b>W362124PO</b>	4030	4107	4126	4168	4178	4198	4242	4246	4294	4328	4379	4431
<b>W372124PO</b>	4051	4126	4146	4188	4198	4221	4266	4269	4318	4353	4405	4457

<b>W392124PO L or R</b>	2518	2592	2613	2654	2666	2688	2734	2737	2786	2823	2877	2930
<b>W392124PO</b>	4071	4145	4166	4207	4219	4241	4287	4290	4339	4376	4430	4483

**Custom Modifications**

ADDTK	AUTHL AUTHR	CBO	CCO	CFNTO	CFRMO	CND	EXBKL EXBKR	EXL EXR	FB	FFDL FFDR	FPEB	ID	INVRM	MIP	P	PFINBTMB	RD	TD	TVRAV TVRFV TVRVV	WLI
•	•	•	•	•	•	•	•	•	•	•	•	•	•	•	•	•	•	•	•	•

**Construction Upgrades**

APC	PE
•	•

**Door Options**

ALF	CG	CG.BTM	CG.TOP	DPSRR	MD	MD.BTM	MD.TOP	MFO
•	•	•	•	•	•	•	•	•

<b>W1224 L or R</b>	473	492	500	519	524	535	556	558	584	600	625	650
<b>W1524 L or R</b>	483	501	511	530	533	547	569	571	597	613	637	663
<b>W1824 L or R</b>	511	527	536	560	563	575	598	601	627	641	668	695
<b>W2124 L or R</b>	561	579	591	616	619	632	657	662	691	707	736	765
<b>W2424 L or R</b>	570	587	600	624	628	639	664	670	700	715	744	773

**Custom Modifications**

ADDTK	AUTHL AUTHR	CBO	CCO	CFNTO	CFRMO	CND	EXBKL EXBKR	EXL EXR	FB	FFDL FFDR	FPEB	ID	INVRM	MIP	P	PFINBTMB	RD	TD	TVRAV TVRFV TVRVV	WLI
•	•	•	•	•	•	•	•	•	•	•	•	•	•	•	•	•	•	•	•	•

**Construction Upgrades**

APC	PE
•	•

**Door Options**

ALF	CG	CG.BTM	CG.TOP	DPSRR	MD	MD.BTM	MD.TOP	MFO
•	•	•	•	•	•	•	•	•

WALL DOUBLE DOOR, 24" HIGH

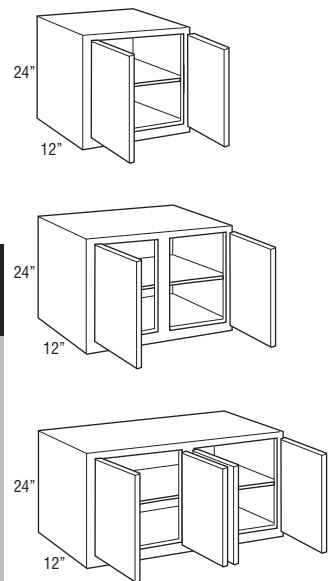

Model	1	2	3	4	5	6
W2424	432	461	582	651	658	686
W2724	450	478	599	655	685	721
W3024	506	539	640	702	715	757
W3324	529	568	664	743	779	823
W3424	538	576	681	764	795	841
W3624	548	583	697	784	813	860
W3724	567	604	718	804	834	880
W3924	585	627	738	823	855	898
W4224	599	635	761	854	892	939
W4524	641	681	817	915	964	1001
W4824CS	684	728	871	975	1035	1062
W4824	766	819	981	1097	1174	1183

WALL REFRIGERATOR SINGLE or DOUBLE DOOR, 24" HIGH, 24" DEEP

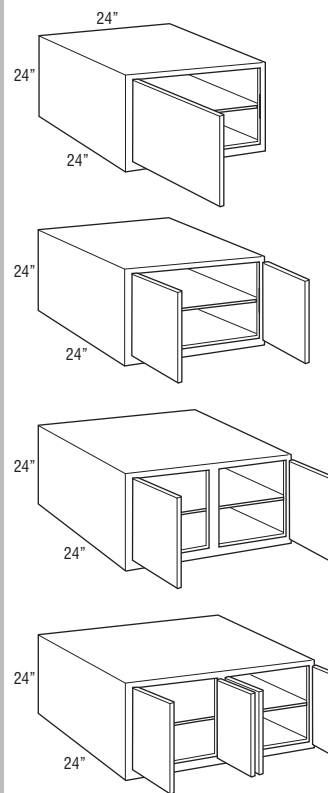

Model	1	2	3	4	5	6
W242424 L or R	524	560	636	739	758	795
W242424	552	588	669	779	797	837
W272424	582	620	701	810	829	871
W302424	612	651	733	840	861	905
W332424	635	677	757	865	917	963
W342424	640	683	772	887	937	986
W362424	644	688	789	910	959	1008
W372424	683	727	829	949	998	1047
W392424	720	764	867	988	1037	1085
W422424	743	790	879	1019	1102	1158
W452424	786	837	934	1074	1173	1216
W482424CS	830	883	989	1128	1245	1273
W482424	917	976	1099	1237	1384	1391

- 24" deep cabinets must be fully supported by screws installed in a structural member in the ceiling or soffit, and into adjacent cabinets.
- Load limit is 15 lbs. per square foot of load bearing surface.
- Shelf is 21" deep on W392424, W422424, W452424, W482424CS, and W482424 to allow for the shelf to be removed from the cabinet.

Model	7	8	9	10	11	12	13	14	15	16	17	18
W2424	716	728	743	769	780	794	827	830	865	886	925	963
W2724	720	765	783	813	821	836	871	874	911	935	975	1015
W3024	772	804	820	854	862	875	911	917	957	979	1018	1058
W3324	818	871	886	925	932	951	989	994	1037	1060	1105	1149
W3424	840	889	907	944	952	971	1010	1015	1059	1084	1130	1174
W3624	863	909	925	963	970	991	1030	1036	1080	1107	1154	1200
W3724	885	932	950	988	995	1016	1057	1062	1107	1136	1184	1231
W3924	908	956	972	1013	1019	1040	1084	1088	1134	1165	1214	1262
W4224	937	998	1017	1058	1068	1088	1133	1137	1184	1216	1267	1317
W4524	1007	1063	1083	1127	1169	1175	1245	1231	1283	1343	1398	1455
W4824CS	1073	1126	1149	1196	1271	1263	1354	1325	1379	1469	1529	1592
W4824	1207	1255	1279	1331	1473	1438	1575	1512	1575	1721	1793	1863

Custom Modifications

ADDTK	AUTHL AUTHR	CBO	CCO	CFNTO	CFRMO	CND	EXBKL EXBKR	EXL EXR	FB	FFDL FFDR	FPEB	ID	INVFRM	MIP	P	PFINBTMB	RD	TD	TVRAV TVRFV TVRVV	WLI	
•	•	•	•	•	•	•	•	•	•	•	•	•	•	•	•	•	•	•	•*	•	•

\*Not available on 39", 42", 45", and 48" wide

Construction Upgrades

APC	PE
•	•

Door Options

ALF	CG	CG.BTM	CG.TOP	DPSRR	MD	MD.BTM	MD.TOP	MFO
•	•	•	•	•	•†	•	•	•

†Available only on 30" and 36" wide

Model	7	8	9	10	11	12	13	14	15	16	17	18
W242424 L or R	814	843	864	896	907	922	961	964	1006	1034	1076	1119
W242424	857	886	909	943	954	970	1011	1015	1057	1087	1133	1176
W272424	890	922	942	979	989	1007	1049	1053	1097	1127	1175	1220
W302424	924	958	975	1015	1023	1043	1086	1089	1136	1167	1216	1264
W332424	950	1019	1040	1084	1091	1114	1160	1165	1214	1246	1297	1348
W342424	974	1043	1064	1108	1117	1139	1185	1189	1241	1272	1326	1378
W362424	999	1066	1087	1132	1140	1165	1212	1215	1266	1300	1354	1408
W372424	1042	1107	1131	1176	1185	1211	1260	1264	1317	1351	1408	1465
W392424	1086	1147	1174	1220	1228	1256	1306	1313	1368	1401	1462	1520
W422424	1122	1225	1253	1302	1314	1340	1393	1397	1457	1497	1560	1623
W452424	1182	1289	1315	1368	1379	1406	1464	1469	1532	1572	1640	1706
W482424CS	1242	1350	1377	1431	1447	1473	1535	1541	1604	1647	1718	1787
W482424	1362	1475	1503	1563	1577	1606	1674	1682	1750	1798	1874	1951

Custom Modifications

ADDTK	AUTHL AUTHR	CBO	CCO	CFNTO	CFRMO	CND	EXBKL EXBKR	EXL EXR	FB	FFDL FFDR	FPEB	ID	INVFRM	MIP	P	PFINBTMB	RD	TD	TVRAV TVRFV TVRVV	WLI	
•	•	•	•	•	•	•	•	•	•	•	•	•	•	•	•	•	•	•	•*	•	•

\*Not available on 39", 42", 45", and 48" wide

Construction Upgrades

APC	PE
•	•

Door Options

ALF	CG	CG.BTM	CG.TOP	DPSRR	MD	MD.BTM	MD.TOP	MFO
•	•	•	•	•	•†	•	•	•

†Available only on 30" and 36" wide

**WALL REFRIGERATOR PULL-OUT,  
24" HIGH, 24" DEEP**

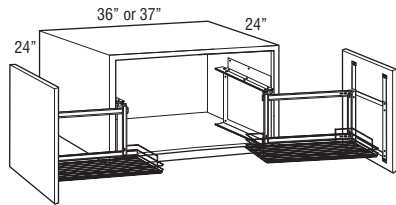

W362424PO L or R  
W372424PO L or R  
W362424PO  
W372424PO

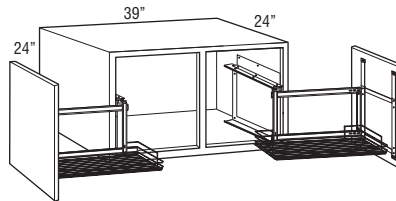

W392424PO L or R  
W392424PO

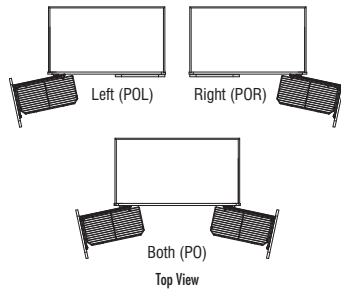

Model	1	2	3	4	5	6
<b>W362424PO L or R</b>	2197	2241	2342	2463	2512	2561
<b>W372424PO L or R</b>	2236	2280	2382	2502	2551	2600
<b>W362424PO</b>	3750	3794	3895	4016	4065	4114
<b>W372424PO</b>	3789	3833	3935	4055	4104	4153
<hr/>						
<b>W392424PO L or R</b>	2273	2317	2420	2541	2590	2638
<b>W392424PO</b>	3826	3870	3973	4094	4143	4191

- Door-mounted pull-out with a chrome wire rack that extends fully to the front of the cabinet then opens to the side for easy accessibility to contents. Designed for use above refrigerators or other high applications. Smart Stop not included.
- Available installed in either the left side, right side, or both sides.
- For sufficient pull-out clearance, 13 1/8" of adjacent space is required for door to open fully when installed near a wall or corner.
- Chrome rack is 10" wide and 20 13/16" deep.
- 24" deep cabinets must be fully supported by screws installed in a structural member in the ceiling or soffit, and into adjacent cabinets.
- Load limit is 20 lbs. per pull-out.

**WALL SINGLE DOOR, 27" HIGH**

12", 15", 18", 21", or 24"

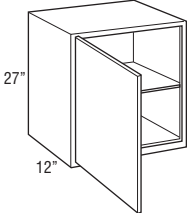

<b>W1227 L or R</b>	338	360	420	474	505	531
<b>W1527 L or R</b>	354	380	443	500	531	560
<b>W1827 L or R</b>	374	401	466	526	560	588
<b>W2127 L or R</b>	395	421	492	553	588	620
<b>W2427 L or R</b>	414	445	517	582	620	653

Model	7	8	9	10	11	12	13	14	15	16	17	18
<b>W362424PO L or R</b>	2552	2619	2640	2685	2693	2718	2765	2768	2819	2853	2907	2961
<b>W372424PO L or R</b>	2595	2660	2684	2729	2738	2764	2813	2817	2870	2904	2961	3018
<b>W362424PO</b>	4105	4172	4193	4238	4246	4271	4318	4321	4372	4406	4460	4514
<b>W372424PO</b>	4148	4213	4237	4282	4291	4317	4366	4370	4423	4457	4514	4571
<hr/>												
<b>W392424PO L or R</b>	2639	2700	2727	2773	2781	2809	2859	2866	2921	2954	3015	3073
<b>W392424PO</b>	4192	4253	4280	4326	4334	4362	4412	4419	4474	4507	4568	4626

**Custom Modifications**

ADDTK	AUTHL AUTHR	CBO	CCO	CFNTO	CFRMO	CND	EXBKL EXBKR	EXL EXR	FB	FFDL FFDR	FPEB	ID	INVRM	MIP	P	PFINBTMB	RD	TD	TVRAV TVRFV TVRVV	WLI
•	•		•		•		•	•	•		•			•		•				•

**Construction Upgrades**

APC	PE
•	•

**Door Options**

ALF	CG	CG.BTM	CG.TOP	DPSRR	MD	MD.BTM	MD.TOP	MFO
				•				•

<b>W1227 L or R</b>	522	566	576	599	603	616	640	643	670	687	718	745
<b>W1527 L or R</b>	550	594	605	631	635	646	675	678	706	725	757	785
<b>W1827 L or R</b>	578	627	637	664	669	681	710	714	742	762	795	826
<b>W2127 L or R</b>	610	660	671	700	704	717	748	752	782	804	837	870
<b>W2427 L or R</b>	639	693	707	736	740	756	787	790	822	844	881	917

**Custom Modifications**

ADDTK	AUTHL AUTHR	CBO	CCO	CFNTO	CFRMO	CND	EXBKL EXBKR	EXL EXR	FB	FFDL FFDR	FPEB	ID	INVRM	MIP	P	PFINBTMB	RD	TD	TVRAV TVRFV TVRVV	WLI
•	•	•	•	•	•		•	•	•	•	•	•		•	•	•	•	•		•

**Construction Upgrades**

APC	PE
•	•

**Door Options**

ALF	CG	CG.BTM	CG.TOP	DPSRR	MD	MD.BTM	MD.TOP	MFO
	•			•				•

**WALL DOUBLE DOOR, 27" HIGH**

24", 27", 30", 33", 34", 36", or 37"

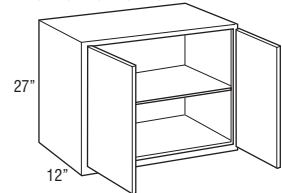

39", 42", 45", or 48"

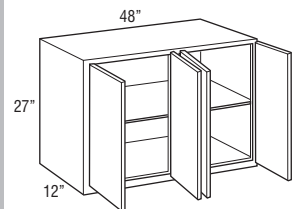
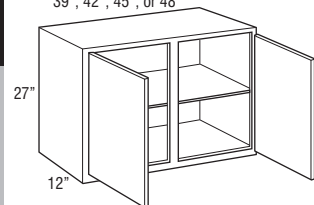

Model	1	2	3	4	5	6
<b>W2427</b>	487	522	610	685	730	767
<b>W2727</b>	514	550	639	720	767	809
<b>W3027</b>	534	573	668	751	801	841
<b>W3327</b>	556	594	697	790	831	875
<b>W3427</b>	566	603	710	811	846	892
<b>W3627</b>	575	613	720	831	864	910
<b>W3727</b>	588	627	737	848	882	929
<b>W3927</b>	601	640	753	867	898	949
<b>W4227</b>	625	668	783	903	934	987
<b>W4527</b>	665	710	832	959	993	1049
<b>W4827CS</b>	703	751	880	1014	1052	1111
<b>W4827</b>	782	834	978	1125	1169	1233

**WALL REFRIGERATOR SINGLE or DOUBLE DOOR, 27" HIGH, 24" DEEP**

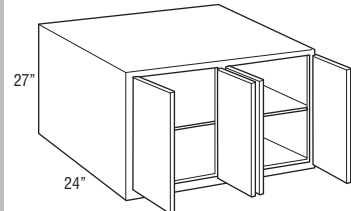
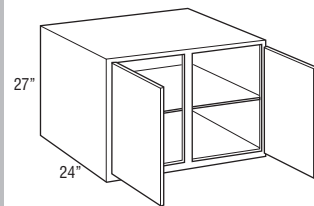
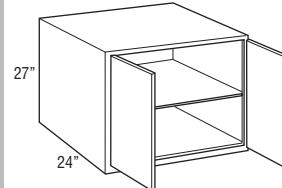
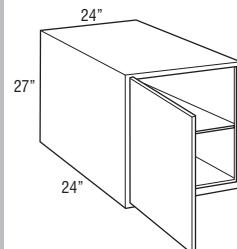

Model	1	2	3	4	5	6
<b>W242724 L or R</b>	509	546	636	716	762	805
<b>W242724</b>	599	641	748	842	897	944
<b>W272724</b>	617	660	763	864	924	975
<b>W302724</b>	633	676	778	883	950	1007
<b>W332724</b>	651	696	815	924	974	1019
<b>W342724</b>	661	707	831	950	992	1039
<b>W362724</b>	670	715	844	974	1009	1059
<b>W372724</b>	686	733	863	994	1032	1082
<b>W392724</b>	702	750	880	1014	1053	1103
<b>W422724</b>	737	787	924	1064	1107	1160
<b>W452724</b>	774	826	970	1117	1162	1218
<b>W482724CS</b>	813	867	1019	1173	1220	1279
<b>W482724</b>	886	945	1111	1279	1330	1394

- 24" deep cabinets must be fully supported by screws installed in a structural member in the ceiling or soffit, and into adjacent cabinets.
- Load limit is 15 lbs. per square foot of load bearing surface.

Model	7	8	9	10	11	12	13	14	15	16	17	18
<b>W2427</b>	755	815	831	867	872	888	925	930	968	993	1037	1077
<b>W2727</b>	792	860	874	912	919	935	974	979	1019	1046	1091	1134
<b>W3027</b>	826	892	912	949	958	975	1015	1019	1062	1089	1136	1181
<b>W3327</b>	870	929	947	985	993	1014	1053	1058	1101	1134	1181	1227
<b>W3427</b>	891	946	966	1004	1012	1033	1073	1077	1122	1155	1203	1251
<b>W3627</b>	914	963	984	1020	1030	1051	1092	1097	1142	1174	1223	1272
<b>W3727</b>	933	985	1005	1043	1052	1073	1116	1121	1168	1200	1250	1301
<b>W3927</b>	954	1007	1024	1065	1075	1095	1138	1145	1194	1224	1275	1328
<b>W4227</b>	990	1046	1066	1108	1117	1138	1183	1192	1241	1273	1327	1381
<b>W4527</b>	1052	1112	1133	1178	1187	1211	1258	1267	1317	1354	1410	1469
<b>W4827CS</b>	1114	1175	1200	1248	1258	1281	1331	1341	1395	1432	1493	1554
<b>W4827</b>	1238	1308	1333	1385	1396	1424	1479	1491	1550	1593	1658	1727

**Custom Modifications**

ADDTK	AUTHL AUTHR	CBO	CCO	CFNTO	CFRMO	CND	EXBKL EXBKR	EXL EXR	FB	FFDL FFDR	FPEB	ID	INVFRM	MIP	P	PFINBTMB	RD	TD	TVRAV TVRFV TVRVV	WLI
•	•	•	•	•	•	•	•	•	•	•	•	•	•	•	•	•	•	•	•	•

\*Not available on 39", 42", 45", and 48" wide

**Construction Upgrades**

APC	PE
•	•

**Door Options**

ALF	CG	CG.BTM	CG.TOP	DPSRR	MD	MD.BTM	MD.TOP	MFO
•	•	•	•	•	•	•	•	•

Model	7	8	9	10	11	12	13	14	15	16	17	18
<b>W242724 L or R</b>	787	853	870	906	911	929	967	971	1013	1039	1084	1126
<b>W242724</b>	928	1002	1021	1065	1073	1093	1138	1144	1192	1222	1274	1325
<b>W272724</b>	951	1034	1054	1099	1106	1128	1174	1179	1228	1260	1312	1365
<b>W302724</b>	972	1065	1086	1131	1138	1162	1209	1214	1264	1298	1350	1404
<b>W332724</b>	1017	1083	1102	1146	1158	1181	1226	1233	1286	1320	1376	1430
<b>W342724</b>	1046	1105	1123	1169	1179	1203	1251	1258	1311	1347	1404	1459
<b>W362724</b>	1073	1125	1144	1190	1202	1224	1274	1280	1335	1373	1429	1488
<b>W372724</b>	1093	1149	1170	1218	1228	1252	1303	1309	1365	1403	1461	1519
<b>W392724</b>	1115	1173	1197	1245	1255	1279	1331	1338	1393	1431	1492	1551
<b>W422724</b>	1170	1232	1256	1306	1317	1343	1398	1404	1462	1504	1565	1628
<b>W452724</b>	1229	1294	1319	1371	1383	1410	1468	1474	1535	1579	1643	1709
<b>W482724CS</b>	1290	1359	1385	1440	1452	1481	1541	1548	1612	1658	1725	1794
<b>W482724</b>	1406	1481	1510	1570	1583	1614	1680	1687	1757	1807	1880	1955

**Custom Modifications**

ADDTK	AUTHL AUTHR	CBO	CCO	CFNTO	CFRMO	CND	EXBKL EXBKR	EXL EXR	FB	FFDL FFDR	FPEB	ID	INVFRM	MIP	P	PFINBTMB	RD	TD	TVRAV TVRFV TVRVV	WLI
•	•	•	•	•	•	•	•	•	•	•	•	•	•	•	•	•	•	•	•	•

\*Not available on 39", 42", 45", and 48" wide

**Construction Upgrades**

APC	PE
•	•

**Door Options**

ALF	CG	CG.BTM	CG.TOP	DPSRR	MD	MD.BTM	MD.TOP	MFO
•	•	•	•	•	•	•	•	•

**WALL SINGLE DOOR, 30" HIGH**

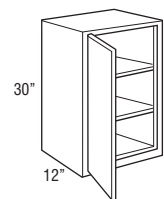

Model	1	2	3	4	5	6
<b>W930 L or R</b>	311	336	390	420	472	497
<b>W1230 L or R</b>	337	358	403	450	490	515
<b>W1530 L or R</b>	352	377	418	493	506	530
<b>W1830 L or R</b>	368	391	452	526	544	573
<b>W2130 L or R</b>	399	425	493	570	599	624
<b>W2430 L or R</b>	449	479	557	643	695	703

Model	7	8	9	10	11	12	13	14	15	16	17	18
<b>W930 L or R</b>	463	526	534	558	562	573	597	599	624	640	667	693
<b>W1230 L or R</b>	496	546	557	578	581	569	619	621	649	680	708	736
<b>W1530 L or R</b>	542	563	575	598	603	615	640	641	668	687	715	744
<b>W1830 L or R</b>	578	610	619	645	651	662	691	693	721	742	771	803
<b>W2130 L or R</b>	627	661	677	703	708	720	752	755	786	809	840	874
<b>W2430 L or R</b>	708	745	762	791	797	814	845	852	884	912	949	987

**Custom Modifications**

ADDTK	AUTHL AUTHR	CBO	CCO	CFNTD	CFRMO	CND	EXBKL EXBKR	EXL EXR	FB	FFDL FFDR	FPEB	ID	INVFRM	MIP	P	PFINBTMB	RD	TD	TVRAV TVRFV TVRVV	WLI
•	•	•	•	•	•	•	•	•	•	•	•	•	•	•	•	•	•	•	•	•

**Construction Upgrades**

APC	PE
•	•

**Door Options**

ALF	CG	CG.BTM	CG.TOP	DPSRR	MD	MD.BTM	MD.TOP	MFO
• <sup>†</sup>	•			•	• <sup>†</sup>			•

<sup>†</sup>Not available on 9" and 24" wide

<sup>†</sup>Not available on 9" and 12" wide

**WALL DOUBLE DOOR, 30" HIGH**

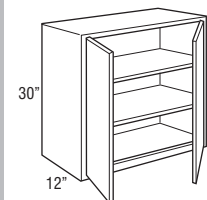

<b>W2430</b>	501	534	621	718	790	783
<b>W2730</b>	530	569	660	763	803	844
<b>W3030</b>	562	601	693	803	834	879
<b>W3330</b>	578	616	727	837	880	925
<b>W3630</b>	602	641	750	878	912	959

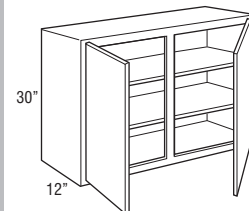

<b>W3930</b>	621	664	777	906	946	994
<b>W4230</b>	634	676	815	949	991	1042
<b>W4530</b>	692	736	889	1034	1080	1131
<b>W4830CS</b>	748	795	962	1117	1168	1218

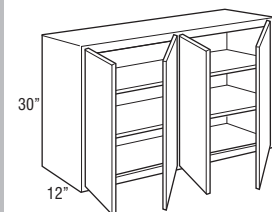

<b>W4830</b>	864	917	1107	1286	1345	1394
--------------	-----	-----	------	------	------	------

<b>W2430</b>	789	830	844	879	885	908	940	946	986	1014	1056	1098
<b>W2730</b>	839	896	914	951	960	979	1017	1023	1065	1093	1139	1184
<b>W3030</b>	881	932	951	989	998	1017	1058	1060	1105	1137	1184	1231
<b>W3330</b>	922	981	1000	1040	1050	1071	1114	1119	1167	1198	1248	1297
<b>W3630</b>	966	1015	1036	1078	1086	1107	1153	1161	1209	1239	1290	1341

<b>W3930</b>	993	1056	1077	1121	1131	1150	1198	1204	1254	1287	1341	1394
<b>W4230</b>	1043	1103	1130	1173	1183	1209	1256	1262	1314	1348	1405	1462
<b>W4530</b>	1136	1198	1223	1272	1283	1309	1363	1368	1424	1462	1523	1586
<b>W4830CS</b>	1228	1291	1317	1371	1382	1410	1466	1473	1535	1575	1642	1709

<b>W4830</b>	1416	1478	1506	1566	1581	1613	1678	1685	1753	1802	1881	1955
--------------	------	------	------	------	------	------	------	------	------	------	------	------

**Custom Modifications**

ADDTK	AUTHL AUTHR	CBO	CCO	CFNTD	CFRMO	CND	EXBKL EXBKR	EXL EXR	FB	FFDL FFDR	FPEB	ID	INVFRM	MIP	P	PFINBTMB	RD	TD	TVRAV TVRFV TVRVV	WLI
•	•	•	•	•	•	•	•	•	•	•	•	•	•	•	•	•	•	•*	•	•

\*Not available on 39", 42", 45", and 48" wide

**Construction Upgrades**

APC	PE
•	•

**Door Options**

ALF	CG	CG.BTM	CG.TOP	DPSRR	MD	MD.BTM	MD.TOP	MFO
•	•			•	• <sup>†</sup>			•

<sup>†</sup>Not available on 39" wide

**WALL SINGLE DOOR, 33" HIGH**

9", 12", 15", 18", 21", or 24"

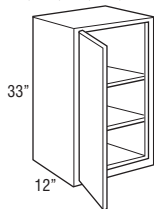

Model	1	2	3	4	5	6
<b>W933 L or R</b>	354	381	435	476	522	550
<b>W1233 L or R</b>	379	404	454	506	551	577
<b>W1533 L or R</b>	399	425	473	551	570	594
<b>W1833 L or R</b>	416	445	507	589	614	641
<b>W2133 L or R</b>	450	477	552	639	672	702
<b>W2433 L or R</b>	506	541	628	726	773	789

**WALL DOUBLE DOOR, 33" HIGH**

24", 27", 30", 33", or 36"

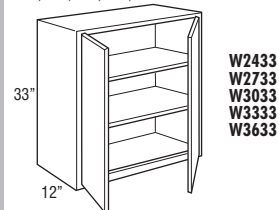

39", 42", 45", or 48"

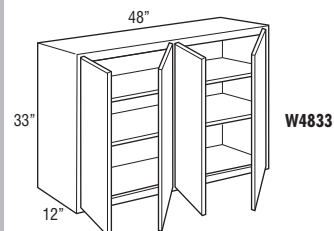

<b>W2433</b>	564	602	702	811	874	877
<b>W2733</b>	598	638	743	862	903	947
<b>W3033</b>	635	678	778	904	938	988
<b>W3333</b>	655	697	815	940	989	1038
<b>W3633</b>	684	730	843	984	1024	1076
<b>W3933</b>	716	765	884	1030	1077	1132
<b>W4233</b>	727	776	911	1058	1103	1162
<b>W4533</b>	792	844	993	1154	1204	1264
<b>W4833CS</b>	860	915	1075	1249	1304	1367
<b>W4833</b>	989	1053	1238	1438	1503	1571

Model	7	8	9	10	11	12	13	14	15	16	17	18
<b>W933 L or R</b>	526	582	592	618	623	634	660	663	689	710	738	767
<b>W1233 L or R</b>	556	612	624	645	651	652	692	696	726	753	784	815
<b>W1533 L or R</b>	604	632	643	671	677	688	718	720	750	769	803	834
<b>W1833 L or R</b>	650	682	696	725	730	744	777	779	811	833	868	904
<b>W2133 L or R</b>	704	743	759	789	793	811	843	845	882	909	944	984
<b>W2433 L or R</b>	797	836	855	888	893	914	949	956	992	1022	1065	1108

**Custom Modifications**

ADDTK	AUTHL AUTHR	CBO	CCO	CFNTO	CFRMO	CND	EXBKL EXBKR	EXL EXR	FB	FFDL FFDR	FPEB	ID	INVFRM	MIP	P	PFINBTMB	RD	TD	TVRAV TVRFV TVRVV	WLI
•	•	•	•	•	•	•	•	•	•	•	•	•	•	•	•	•	•	•	•	•

**Construction Upgrades**

APC	PE
•	•

**Door Options**

ALF	CG	CG.BTM	CG.TOP	DPSRR	MD	MD.BTM	MD.TOP	MFO
•	•	•	•	•	• <sup>†</sup>	•	•	•

<sup>†</sup>Not available on 9" and 12" wide

<b>W2433</b>	890	930	949	986	993	1017	1056	1062	1105	1136	1183	1229
<b>W2733</b>	944	1006	1023	1066	1074	1096	1139	1146	1195	1224	1277	1327
<b>W3033</b>	991	1047	1069	1112	1122	1141	1188	1195	1245	1278	1331	1385
<b>W3333</b>	1036	1100	1124	1168	1178	1201	1251	1256	1309	1343	1398	1454
<b>W3633</b>	1083	1139	1164	1212	1221	1245	1296	1302	1355	1393	1450	1507
<b>W3933</b>	1133	1199	1222	1272	1284	1308	1363	1369	1425	1462	1522	1583
<b>W4233</b>	1164	1227	1255	1305	1316	1343	1397	1404	1462	1501	1564	1627
<b>W4533</b>	1269	1338	1367	1420	1432	1461	1519	1528	1592	1633	1703	1770
<b>W4833CS</b>	1373	1447	1476	1535	1549	1578	1642	1651	1719	1765	1839	1913

<b>W4833</b>	1582	1662	1696	1762	1781	1812	1888	1897	1976	2028	2116	2200
--------------	------	------	------	------	------	------	------	------	------	------	------	------

**Custom Modifications**

ADDTK	AUTHL AUTHR	CBO	CCO	CFNTO	CFRMO	CND	EXBKL EXBKR	EXL EXR	FB	FFDL FFDR	FPEB	ID	INVFRM	MIP	P	PFINBTMB	RD	TD	TVRAV TVRFV TVRVV	WLI
•	•	•	•	•	•	•	•	•	•	•	•	•	•	•	•	•	•	•	•	•

**Construction Upgrades**

APC	PE
•	•

**Door Options**

ALF	CG	CG.BTM	CG.TOP	DPSRR	MD	MD.BTM	MD.TOP	MFO
•	•	•	•	•	• <sup>†</sup>	•	•	•

<sup>†</sup>Not available on 39" wide

WALL SINGLE DOOR, 36" HIGH

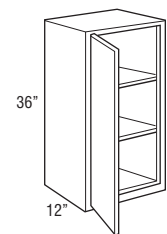

Model	1	2	3	4	5	6
W936 L or R	399	426	478	533	573	601
W1236 L or R	420	448	503	562	611	637
W1536 L or R	443	472	528	609	632	660
W1836 L or R	465	496	564	655	681	712
W2136 L or R	501	531	612	710	744	779
W2436 L or R	564	601	696	808	853	874

Model	7	8	9	10	11	12	13	14	15	16	17	18
W936 L or R	587	637	650	677	682	696	721	727	757	778	810	841
W1236 L or R	618	676	688	715	720	736	764	769	804	824	861	892
W1536 L or R	668	700	712	743	750	763	794	797	831	854	886	923
W1836 L or R	720	757	771	804	810	827	863	864	898	924	963	1000
W2136 L or R	782	824	839	874	880	898	935	937	979	1008	1049	1092
W2436 L or R	885	927	946	985	991	1014	1051	1057	1100	1134	1181	1227

Custom Modifications

ADDTK	AUTHL AUTHR	CBO	CCO	CFNTO	CFRMO	CND	EXBKL EXBKR	EXL EXR	FB	FFDL FFDR	FPEB	ID	INVFRM	MIP	P	PFINBTMB	RD	TD	TVRAV TVRFV TVRVV	WLI
•	•	•	•	•	•	•	•	•	•	•	•	•	•	•	•	•	•	•	•	•

Construction Upgrades

APC	PE
•	•

Door Options

ALF	CG	CG.BTM	CG.TOP	DPSRR	MD	MD.BTM	MD.TOP	MFO
• <sup>†</sup>	•			•	• <sup>†</sup>			•

<sup>†</sup>Not available on 9" and 24" wide

<sup>†</sup>Not available on 9" and 12" wide

WALL DOUBLE DOOR, 36" HIGH

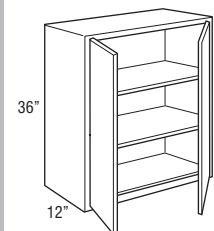

W2436  
W2736  
W3036  
W3336  
W3636

W2436	628	669	782	905	959	970
W2736	664	709	827	958	999	1049
W3036	708	755	863	1000	1044	1096
W3336	731	778	905	1044	1097	1150
W3636	764	818	936	1088	1137	1195

39", 42", 45", or 48"

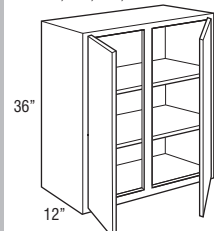

W3936  
W4236  
W4536  
W4836CS

W3936	811	867	993	1155	1205	1267
W4236	819	874	1005	1166	1217	1279
W4536	893	956	1096	1272	1328	1396
W4836CS	968	1035	1187	1377	1438	1513

W4836	1116	1194	1370	1590	1659	1746
-------	------	------	------	------	------	------

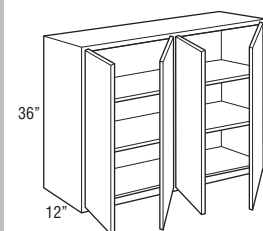

W4836

W2436	992	1030	1051	1092	1101	1126	1169	1174	1223	1259	1311	1364
W2736	1051	1112	1134	1179	1188	1214	1262	1269	1322	1355	1413	1469
W3036	1100	1163	1186	1232	1245	1268	1319	1327	1381	1420	1478	1539
W3336	1149	1220	1247	1296	1306	1333	1388	1394	1451	1489	1550	1610
W3636	1199	1266	1290	1342	1354	1381	1438	1445	1504	1546	1607	1674

W3936	1270	1342	1368	1423	1437	1463	1524	1532	1596	1638	1704	1772
W4236	1283	1351	1381	1436	1449	1478	1539	1547	1609	1652	1722	1793
W4536	1399	1476	1507	1566	1581	1613	1679	1687	1757	1803	1880	1955
W4836CS	1515	1600	1633	1697	1714	1747	1818	1829	1903	1954	2036	2118

W4836	1748	1848	1885	1958	1978	2014	2098	2108	2199	2255	2350	2441
-------	------	------	------	------	------	------	------	------	------	------	------	------

Custom Modifications

ADDTK	AUTHL AUTHR	CBO	CCO	CFNTO	CFRMO	CND	EXBKL EXBKR	EXL EXR	FB	FFDL FFDR	FPEB	ID	INVFRM	MIP	P	PFINBTMB	RD	TD	TVRAV TVRFV TVRVV	WLI
•	•	•	•	•	•	•	•	•	•	•	•	•	•	•	•	•	•	•	•	•

Construction Upgrades

APC	PE
•	•

Door Options

ALF	CG	CG.BTM	CG.TOP	DPSRR	MD	MD.BTM	MD.TOP	MFO
	•			•	• <sup>†</sup>			•

<sup>†</sup>Not available on 39" wide

**WALL SINGLE DOOR, 39" HIGH**

9", 12", 15", 18", 21" or 24"

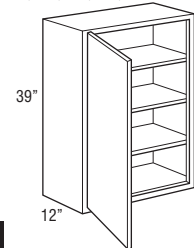

Model	1	2	3	4	5	6
<b>W939 L or R</b>	438	468	527	587	629	661
<b>W1239 L or R</b>	463	493	553	618	670	701
<b>W1539 L or R</b>	486	519	580	668	695	726
<b>W1839 L or R</b>	512	546	620	720	750	785
<b>W2139 L or R</b>	551	584	671	782	819	857
<b>W2439 L or R</b>	620	661	765	885	936	963

Model	7	8	9	10	11	12	13	14	15	16	17	18
<b>W939 L or R</b>	645	701	714	744	751	765	792	798	832	856	889	925
<b>W1239 L or R</b>	680	743	758	787	791	811	840	845	882	909	944	984
<b>W1539 L or R</b>	735	769	785	818	824	839	874	878	914	937	976	1016
<b>W1839 L or R</b>	791	832	847	882	889	911	947	949	989	1017	1058	1100
<b>W2139 L or R</b>	861	909	923	963	968	989	1030	1032	1076	1110	1155	1201
<b>W2439 L or R</b>	975	1020	1041	1083	1091	1115	1160	1164	1213	1248	1299	1349

**Custom Modifications**

ADDTK	AUTHL AUTHR	CBO	CCO	CFNTO	CFRMO	CND	EXBKL EXBKR	EXL EXR	FB	FFDL FFDR	FPEB	ID	INVFRM	MIP	P	PFINBTMB	RD	TD	TAVR TVRFV TVRVV	WLI
•	•	•	•	•	•	•	•	•	•	•	•	•	•	•	•	•	•	•	•	•

**Construction Upgrades**

APC	PE
•	•

**Door Options**

ALF	CG	CG.BTM	CG.TOP	DPSRR	MD	MD.BTM	MD.TOP	MFO
•	•	•	•	•	• <sup>†</sup>	•	•	•

<sup>†</sup>Not available on 9" and 12" wide

<b>W2439</b>	1092	1133	1160	1202	1214	1241	1286	1293	1346	1387	1443	1501
<b>W2739</b>	1160	1221	1248	1298	1308	1335	1389	1395	1454	1493	1553	1616
<b>W3039</b>	1213	1278	1305	1355	1368	1394	1450	1458	1519	1560	1626	1691
<b>W3339</b>	1266	1342	1371	1426	1437	1465	1524	1535	1597	1636	1704	1772
<b>W3639</b>	1319	1392	1420	1476	1491	1519	1581	1590	1655	1699	1769	1839

<b>W3939</b>	1396	1476	1504	1564	1579	1608	1679	1685	1753	1801	1874	1951
<b>W4239</b>	1408	1489	1519	1578	1595	1626	1691	1700	1771	1816	1896	1971
<b>W4539</b>	1539	1624	1658	1722	1742	1774	1846	1855	1933	1982	2068	2149
<b>W4839CS</b>	1666	1758	1797	1867	1886	1923	2001	2009	2095	2148	2240	2329

<b>W4839</b>	1923	2032	2074	2154	2177	2217	2308	2318	2418	2479	2584	2686
--------------	------	------	------	------	------	------	------	------	------	------	------	------

**Custom Modifications**

ADDTK	AUTHL AUTHR	CBO	CCO	CFNTO	CFRMO	CND	EXBKL EXBKR	EXL EXR	FB	FFDL FFDR	FPEB	ID	INVFRM	MIP	P	PFINBTMB	RD	TD	TAVR TVRFV TVRVV	WLI
•	•	•	•	•	•	•	•	•	•	•	•	•	•	•	•	•	•	•	•	•

**Construction Upgrades**

APC	PE
•	•

**Door Options**

ALF	CG	CG.BTM	CG.TOP	DPSRR	MD	MD.BTM	MD.TOP	MFO
•	•	•	•	•	• <sup>†</sup>	•	•	•

<sup>†</sup>Not available on 39" wide

**WALL DOUBLE DOOR, 39" HIGH**

24", 27", 30", 33", or 36"

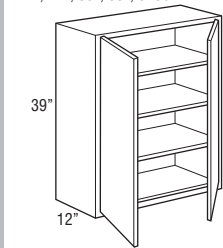

W2439  
W2739  
W3039  
W3339  
W3639

39", 42", 45", or 48"

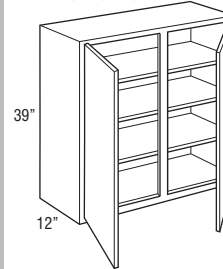

W3939  
W4239  
W4539  
W4839CS

48"

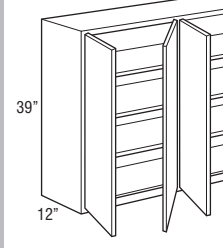

W4839

<b>W2439</b>	691	736	861	992	1052	1069
<b>W2739</b>	731	780	911	1051	1099	1155
<b>W3039</b>	779	830	947	1100	1149	1205
<b>W3339</b>	806	856	992	1149	1207	1267
<b>W3639</b>	840	898	1031	1199	1252	1314

<b>W3939</b>	891	954	1093	1270	1327	1393
<b>W4239</b>	903	963	1103	1283	1339	1406
<b>W4539</b>	984	1051	1204	1399	1459	1537
<b>W4839CS</b>	1064	1138	1305	1515	1581	1664

<b>W4839</b>	1226	1313	1506	1748	1826	1921
--------------	------	------	------	------	------	------



**WALL SINGLE DOOR, 42" HIGH**

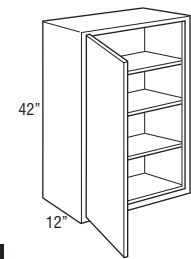

Model	1	2	3	4	5	6
<b>W942 L or R</b>	479	514	573	640	696	721
<b>W1242 L or R</b>	504	537	603	671	733	768
<b>W1542 L or R</b>	531	570	637	742	755	794
<b>W1842 L or R</b>	561	600	677	787	813	854
<b>W2142 L or R</b>	603	643	734	854	889	934
<b>W2442 L or R</b>	678	724	834	967	1011	1050

Model	7	8	9	10	11	12	13	14	15	16	17	18
<b>W942 L or R</b>	706	765	783	813	821	836	871	874	911	935	975	1015
<b>W1242 L or R</b>	738	817	832	867	873	889	927	931	969	996	1038	1080
<b>W1542 L or R</b>	817	840	862	892	904	918	957	962	1000	1027	1069	1112
<b>W1842 L or R</b>	867	907	923	960	967	988	1026	1031	1075	1101	1146	1194
<b>W2142 L or R</b>	937	990	1010	1050	1059	1082	1125	1130	1175	1211	1259	1309
<b>W2442 L or R</b>	1065	1115	1136	1182	1192	1216	1264	1270	1322	1361	1419	1473

**Custom Modifications**

ADDTK	AUTHL AUTHR	CBO	CCO	CFNTO	CFRMO	CND	EXBKL EXBKR	EXL EXR	FB	FFDL FFDR	FPEB	ID	INVFRM	MIP	P	PFINBTMB	RD	TD	TVRAV TVRFV TVRVV	WLI
•	•	•	•	•	•	•	•	•	•	•	•	•	•	•	•	•	•	•	•	•

**Construction Upgrades**

APC	PE
•	•

**Door Options**

ALF	CG	CG.BTM	CG.TOP	DPSRR	MD	MD.BTM	MD.TOP	MFO
•	•	•	•	•	• <sup>†</sup>	•	•	•

<sup>†</sup>Not available on 9" and 12" wide

**WALL DOUBLE DOOR, 42" HIGH**

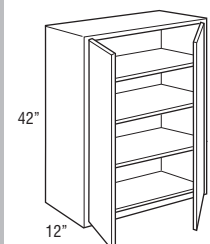

W2442  
W2742  
W3042  
W3342  
W3642

39", 42", 45", or 48"

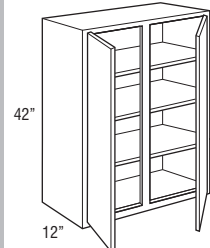

W3942  
W4242  
W4542  
W4842CS

<b>W2442</b>	751	801	934	1082	1131	1167
<b>W2742</b>	795	849	991	1144	1197	1260
<b>W3042</b>	860	914	1030	1198	1251	1316
<b>W3342</b>	878	935	1082	1248	1314	1387
<b>W3642</b>	934	993	1125	1299	1367	1437
<b>W3942</b>	991	1052	1190	1377	1448	1522
<b>W4242</b>	1000	1063	1203	1391	1462	1538
<b>W4542</b>	1092	1161	1313	1517	1596	1678
<b>W4842CS</b>	1183	1256	1423	1644	1728	1816
<b>W4842</b>	1366	1450	1641	1897	1995	2097

<b>W2442</b>	1189	1237	1262	1313	1324	1348	1401	1408	1469	1511	1574	1638
<b>W2742</b>	1259	1335	1362	1416	1430	1457	1516	1522	1588	1633	1699	1768
<b>W3042</b>	1316	1395	1424	1480	1493	1522	1583	1593	1657	1702	1773	1844
<b>W3342</b>	1373	1467	1497	1556	1572	1602	1666	1676	1745	1794	1867	1943
<b>W3642</b>	1429	1522	1552	1616	1628	1659	1728	1738	1808	1856	1936	2012
<b>W3942</b>	1514	1613	1647	1712	1727	1757	1833	1843	1921	1971	2051	2132
<b>W4242</b>	1529	1628	1662	1729	1744	1777	1849	1857	1938	1987	2073	2154
<b>W4542</b>	1668	1777	1813	1887	1902	1939	2016	2028	2116	2170	2260	2351
<b>W4842CS</b>	1807	1926	1965	2043	2061	2100	2185	2199	2291	2351	2447	2547
<b>W4842</b>	2087	2222	2267	2357	2379	2423	2522	2537	2643	2712	2824	2938

**Custom Modifications**

ADDTK	AUTHL AUTHR	CBO	CCO	CFNTO	CFRMO	CND	EXBKL EXBKR	EXL EXR	FB	FFDL FFDR	FPEB	ID	INVFRM	MIP	P	PFINBTMB	RD	TD	TVRAV TVRFV TVRVV	WLI
•	•	•	•	•	•	•	•	•	•	•	•	•	•	•	•	•	•	•	•	•

**Construction Upgrades**

APC	PE
•	•

**Door Options**

ALF	CG	CG.BTM	CG.TOP	DPSRR	MD	MD.BTM	MD.TOP	MFO
•	•	•	•	•	• <sup>†</sup>	•	•	•

<sup>†</sup>Not available on 39" wide

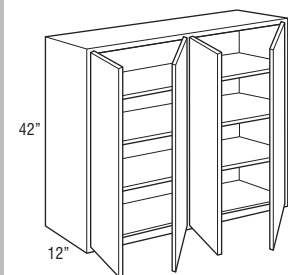

W4842

**WALL EASY ACCESS STORAGE CABINET, 30" HIGH**

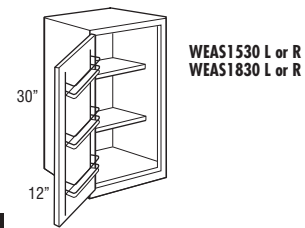

WEAS1530 L or R  
WEAS1830 L or R

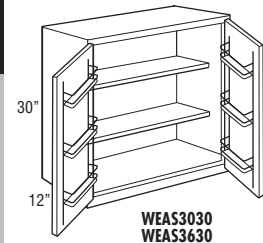

WEAS3030  
WEAS3630

Model	1	2	3	4	5	6
WEAS1530 L or R	526	551	592	667	680	704
WEAS1830 L or R	542	565	626	700	718	747
WEAS3030	872	911	1003	1113	1144	1189
WEAS3630	912	951	1060	1188	1222	1269

- Adjustable shelves are 7 1/2" deep.
- Each door features a chrome and wood three-tiered rack.
- Door rack width is 9 3/8" on 15" and 30" wide cabinets.
- Door rack width is 12 3/8" on 18" and 36" wide cabinets.
- Door rack depth is 3".

**WALL TWO DRAWER CABINET, 18" HIGH, 12" DEEP**

12", 15", 18", 21", 24", 27", 30", 33", or 36"

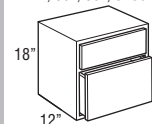

W2D1218	807	807	807	807	815	837
W2D1518	894	894	894	894	907	931
W2D1818	932	932	932	932	951	980
W2D2118	972	972	972	972	993	1029
W2D2418	1023	1023	1023	1023	1065	1065
W2D2718	1085	1085	1085	1085	1129	1129
W2D3018	1146	1146	1146	1146	1194	1194
W2D3318	1208	1208	1208	1208	1257	1257
W2D3618	1269	1269	1269	1269	1321	1321

Model	7	8	9	10	11	12	13	14	15	16	17	18
WEAS1530 L or R	716	737	749	772	777	789	814	815	842	861	889	918
WEAS1830 L or R	752	784	793	819	825	836	865	867	895	916	945	977
WEAS3030	1191	1242	1261	1299	1308	1327	1368	1370	1415	1447	1494	1541
WEAS3630	1276	1325	1346	1388	1396	1417	1463	1471	1519	1549	1600	1651

**Custom Modifications**

ADDTK	AUTHL AUTHR	CBO	CCO	CFNTO	CFRMO	CND	EXBKL EXBKR	EXL EXR	FB	FFDL FFDR	FPEB	ID	INVFRM	MIP	P	PFINBTMB	RD	TD	TVRAV TVRFV TVRVV	WLI
•	•	•	•	•	•		•	•	•		•			•		•				•

**Construction Upgrades**

APC	PE
•	•

**Door Options**

ALF	CG	CG.BTM	CG.TOP	DPSRR	MD	MD.BTM	MD.TOP	MFO
				•				•

W2D1218	860	867	875	896	904	913	932	935	960	975	1001	1031
W2D1518	954	963	972	995	1000	1014	1037	1039	1066	1084	1114	1144
W2D1818	992	1014	1024	1048	1052	1069	1092	1093	1123	1141	1173	1209
W2D2118	1037	1065	1078	1102	1111	1123	1150	1154	1183	1204	1235	1271
W2D2418	1089	1102	1117	1144	1150	1165	1194	1199	1227	1252	1286	1322
W2D2718	1155	1168	1183	1213	1219	1235	1264	1270	1301	1327	1364	1401
W2D3018	1220	1233	1251	1281	1289	1305	1336	1342	1375	1403	1440	1480
W2D3318	1285	1301	1317	1350	1357	1374	1408	1414	1449	1476	1517	1559
W2D3618	1351	1367	1384	1418	1426	1445	1479	1487	1522	1552	1595	1639

**Custom Modifications**

ADDTK	AUTHL AUTHR	CBO	CCO	CFNTO	CFRMO	CND	EXBKL EXBKR	EXL EXR	FB	FFDL FFDR	FPEB	ID	INVFRM	MIP	P	PFINBTMB	RD	TD	TVRAV TVRFV TVRVV	WLI
•	•	•	•	•	•		•	•	•		•			•		•				•

**Construction Upgrades**

APC	PE
•	•

**Door Options**

ALF	CG	CG.BTM	CG.TOP	DPSRR	MD	MD.BTM	MD.TOP	MFO
				•				•

**WALL TWO DRAWER SINGLE DOOR CABINET, 48", 51", 54", 57", or 60" HIGH, 12" DEEP**

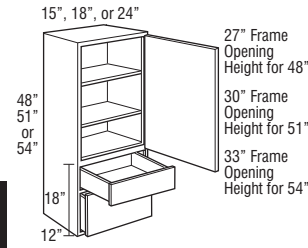

27" Frame Opening Height for 48"  
 W2D1548 L or R  
 W2D1848 L or R  
 W2D2448 L or R

30" Frame Opening Height for 51"  
 W2D1551 L or R  
 W2D1851 L or R  
 W2D2451 L or R

33" Frame Opening Height for 54"  
 W2D1554 L or R  
 W2D1854 L or R  
 W2D2454 L or R

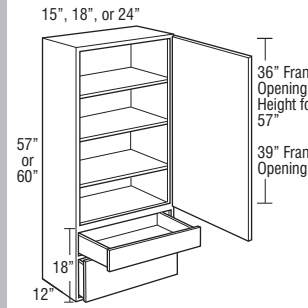

36" Frame Opening Height for 57"  
 W2D1557 L or R  
 W2D1857 L or R  
 W2D2457 L or R

39" Frame Opening  
 W2D1560 L or R  
 W2D1860 L or R  
 W2D2460 L or R

Model	1	2	3	4	5	6
W2D1548 L or R	965	989	1037	1117	1088	1393
W2D1848 L or R	1019	1046	1112	1190	1173	1481
W2D2448 L or R	1181	1213	1285	1377	1499	1719
W2D1551 L or R	1015	1041	1096	1179	1158	1462
W2D1851 L or R	1074	1101	1172	1262	1247	1558
W2D2451 L or R	1251	1286	1368	1470	1597	1815
W2D1554 L or R	1063	1093	1155	1242	1224	1534
W2D1854 L or R	1126	1158	1233	1333	1319	1635
W2D2454 L or R	1321	1362	1448	1560	1693	1913
W2D1557 L or R	1157	1189	1255	1348	1333	1666
W2D1857 L or R	1224	1258	1343	1449	1435	1780
W2D2457 L or R	1437	1480	1575	1698	1840	2082
W2D1560 L or R	1162	1200	1274	1387	1357	1681
W2D1860 L or R	1228	1269	1354	1473	1462	1786
W2D2460 L or R	1462	1508	1608	1749	1900	2117

Model	7	8	9	10	11	12	13	14	15	16	17	18
W2D1548 L or R	1227	1477	1505	1565	1579	1610	1676	1684	1752	1801	1879	1954
W2D1848 L or R	1310	1572	1602	1666	1682	1714	1784	1794	1867	1917	1999	2078
W2D2448 L or R	1514	1824	1859	1932	1950	1987	2068	2079	2165	2222	2315	2409
W2D1551 L or R	1297	1551	1581	1646	1660	1693	1760	1769	1842	1894	1973	2052
W2D1851 L or R	1389	1652	1685	1752	1768	1803	1874	1886	1961	2014	2100	2184
W2D2451 L or R	1617	1926	1966	2043	2060	2102	2185	2200	2291	2351	2446	2545
W2D1554 L or R	1366	1626	1657	1725	1741	1776	1845	1853	1930	1985	2067	2149
W2D1854 L or R	1465	1733	1768	1839	1853	1893	1965	1977	2057	2114	2203	2291
W2D2454 L or R	1718	2031	2073	2154	2173	2216	2303	2317	2415	2478	2581	2683
W2D1557 L or R	1484	1769	1801	1875	1893	1930	2007	2013	2099	2159	2249	2337
W2D1857 L or R	1595	1885	1922	2001	2013	2057	2138	2149	2236	2299	2393	2489
W2D2457 L or R	1867	2208	2255	2344	2361	2412	2506	2520	2623	2694	2809	2918
W2D1560 L or R	1523	1782	1815	1889	1902	1943	2021	2032	2116	2175	2263	2353
W2D1860 L or R	1620	1894	1930	2007	2026	2065	2148	2157	2248	2310	2408	2503
W2D2460 L or R	1924	2242	2288	2379	2401	2446	2545	2558	2665	2735	2850	2965

**Custom Modifications**

ADDTK	AUTHL AUTHR	CBO	CCO	CFNTO	CFRMO	CND	EXBKL EXBKR	EXL EXR	FB	FFDL FFDR	FPEB	ID	INVFRM	MIP	P	PFINBTMB	RD	TD	TVRAV TVRFV TVRVV	WLI
•	•	•	•		•	•	•	•	•		•	•		•						•

**Construction Upgrades**

APC	PE
•	•

**Door Options**

ALF	CG	CG.BTM	CG.TOP	DPSRR	MD	MD.BTM	MD.TOP	MFO
	•			•	•			•

**WALL TWO DRAWER DOUBLE DOOR CABINET, 48", 51", 54", 57", or 60" HIGH, 12" DEEP**

24", 27", 30", 33", or 36"

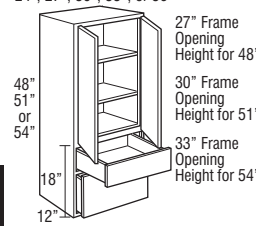

W2D2448  
W2D2748  
W2D3048  
W2D3348  
W2D3648  
W2D2451  
W2D2751  
W2D3051  
W2D3351  
W2D3651  
W2D2454  
W2D2754  
W2D3054  
W2D3354  
W2D3654

24", 27", 30", 33", or 36"

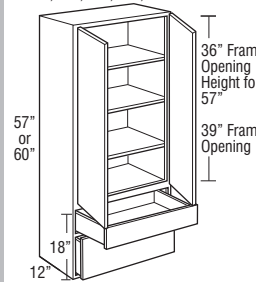

W2D2457  
W2D2757  
W2D3057  
W2D3357  
W2D3657  
W2D2460  
W2D2760  
W2D3060  
W2D3360  
W2D3660

Model	1	2	3	4	5	6
W2D2448	1245	1274	1351	1450	1577	1808
W2D2748	1319	1351	1431	1537	1671	1917
W2D3048	1394	1427	1513	1623	1766	2025
W2D3348	1468	1504	1594	1710	1860	2134
W2D3648	1543	1581	1675	1797	1956	2243
W2D2451	1317	1353	1439	1547	1681	1912
W2D2751	1397	1435	1525	1640	1782	2027
W2D3051	1475	1515	1612	1732	1883	2141
W2D3351	1555	1597	1699	1826	1983	2256
W2D3651	1634	1678	1785	1918	2084	2371
W2D2454	1391	1432	1523	1644	1783	2013
W2D2754	1474	1518	1615	1743	1889	2134
W2D3054	1557	1604	1707	1842	1996	2255
W2D3354	1641	1690	1798	1940	2103	2376
W2D3654	1724	1777	1889	2039	2210	2497
W2D2457	1512	1558	1658	1787	1939	2190
W2D2757	1603	1651	1757	1893	2055	2322
W2D3057	1693	1746	1856	2001	2172	2453
W2D3357	1785	1839	1956	2107	2289	2585
W2D3657	1876	1932	2055	2216	2404	2716
W2D2460	1540	1589	1694	1842	2001	2228
W2D2760	1632	1684	1796	1953	2122	2362
W2D3060	1724	1780	1897	2062	2241	2495
W2D3360	1816	1875	1999	2174	2361	2629
W2D3660	1909	1970	2101	2284	2481	2763

Model	7	8	9	10	11	12	13	14	15	16	17	18
W2D2448	1596	1918	1957	2036	2051	2092	2177	2188	2278	2338	2436	2534
W2D2748	1692	2034	2075	2158	2175	2218	2307	2319	2416	2478	2583	2685
W2D3048	1788	2148	2191	2279	2297	2343	2438	2451	2551	2619	2728	2838
W2D3348	1884	2264	2310	2401	2421	2469	2568	2582	2688	2759	2875	2989
W2D3648	1979	2379	2427	2524	2543	2594	2699	2714	2824	2899	3021	3142
W2D2451	1702	2028	2070	2151	2170	2213	2301	2314	2411	2474	2579	2679
W2D2751	1804	2149	2194	2280	2299	2345	2439	2453	2555	2623	2733	2840
W2D3051	1906	2272	2318	2411	2430	2478	2578	2591	2699	2771	2888	3001
W2D3351	2008	2393	2442	2539	2560	2611	2716	2730	2845	2920	3044	3162
W2D3651	2109	2515	2567	2668	2690	2743	2854	2870	2988	3067	3197	3321
W2D2454	1807	2138	2181	2267	2287	2333	2425	2438	2539	2609	2717	2824
W2D2754	1916	2267	2312	2402	2424	2473	2570	2585	2691	2766	2880	2995
W2D3054	2024	2394	2442	2539	2561	2612	2716	2731	2843	2922	3044	3164
W2D3354	2133	2523	2573	2675	2697	2753	2861	2877	2997	3079	3206	3334
W2D3654	2241	2651	2705	2811	2835	2892	3007	3023	3148	3235	3368	3503
W2D2457	1965	2326	2373	2467	2484	2537	2637	2652	2764	2837	2954	3072
W2D2757	2084	2465	2515	2614	2633	2688	2795	2811	2929	3008	3130	3257
W2D3057	2201	2605	2657	2763	2782	2841	2954	2970	3096	3177	3308	3441
W2D3357	2319	2744	2800	2911	2931	2994	3112	3129	3261	3348	3485	3626
W2D3657	2437	2883	2942	3059	3081	3146	3270	3289	3427	3518	3661	3810
W2D2460	2026	2359	2409	2505	2527	2578	2679	2692	2806	2879	3000	3121
W2D2760	2147	2500	2553	2655	2679	2732	2840	2854	2974	3052	3179	3308
W2D3060	2269	2641	2696	2805	2831	2887	3001	3016	3143	3224	3359	3496
W2D3360	2390	2784	2841	2956	2982	3042	3162	3177	3311	3397	3540	3683
W2D3660	2513	2925	2985	3105	3134	3196	3321	3340	3479	3569	3720	3870

Custom Modifications

ADDTK	AUTHL AUTHR	CBO	CCO	CFNTO	CFRMO	CND	EXBKL EXBKR	EXL EXR	FB	FFDL FFDR	FPEB	ID	INVERM	MIP	P	PFINBTMB	RD	TD	TVRAV TVRFV TVRVV	WLI
•	•	•	•		•	•	•	•	•		•	•		•						•

Construction Upgrades

APC	PE
•	•

Door Options

ALF	CG	CG.BTM	CG.TOP	DPSRR	MD	MD.BTM	MD.TOP	MFO
•				•	•			•

**WALL THREE DRAWER SINGLE DOOR, 48", 51", 54", 57", or 60" HIGH**

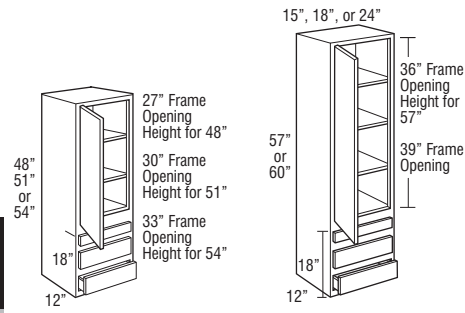

W3D1548 L or R  
W3D1848 L or R  
W3D2448 L or R

W3D1551 L or R  
W3D1851 L or R  
W3D2451 L or R

W3D1554 L or R  
W3D1854 L or R  
W3D2454 L or R

W3D1557 L or R  
W3D1857 L or R  
W3D2457 L or R

W3D1560 L or R  
W3D1860 L or R  
W3D2460 L or R

Model	1	2	3	4	5	6
W3D1548 L or R	965	989	1037	1117	1088	1393
W3D1848 L or R	1019	1046	1112	1190	1173	1481
W3D2448 L or R	1181	1213	1285	1377	1499	1719
W3D1551 L or R	1015	1041	1096	1179	1158	1462
W3D1851 L or R	1074	1101	1172	1262	1247	1558
W3D2451 L or R	1251	1286	1368	1470	1597	1815
W3D1554 L or R	1063	1093	1155	1242	1224	1534
W3D1854 L or R	1126	1158	1233	1333	1319	1635
W3D2454 L or R	1321	1362	1448	1560	1693	1913
W3D1557 L or R	1157	1189	1255	1348	1333	1666
W3D1857 L or R	1224	1258	1343	1449	1435	1780
W3D2457 L or R	1437	1480	1575	1698	1840	2082
W3D1560 L or R	1162	1200	1274	1387	1357	1681
W3D1860 L or R	1228	1269	1354	1473	1462	1786
W3D2460 L or R	1462	1508	1608	1749	1900	2117

- Includes one shallow depth drawer and two standard drawers.
- Top drawer will be slab drawer front for all 5-piece drawer and Drawer Front Raised applications.
- Drawer front to face frame reveal is justified to the top to be consistent with both full and partial overlay. Bottom reveal is 1" for both full and partial overlay.

**WALL THREE DRAWER DOUBLE DOOR, 48", 51", 54", 57", or 60" HIGH**

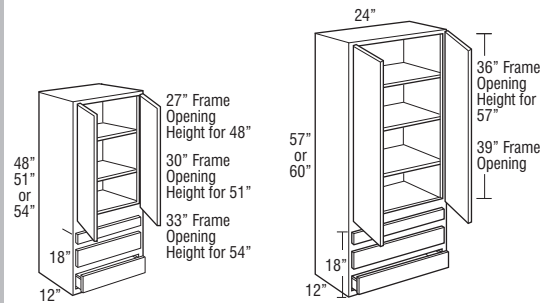

W3D2448  
W3D2451  
W3D2454

W3D2457  
W3D2460

W3D2448	1245	1274	1351	1450	1577	1808
W3D2451	1317	1353	1439	1547	1681	1912
W3D2454	1391	1432	1523	1644	1783	2013
W3D2457	1512	1558	1658	1787	1939	2190
W3D2460	1540	1589	1694	1842	2001	2228

- Includes one shallow depth drawer and two standard drawers.
- Top drawer will be slab drawer front for all 5-piece drawer and Drawer Front Raised applications.
- Drawer front to face frame reveal is justified to the top to be consistent with both full and partial overlay. Bottom reveal is 1" for both full and partial overlay.

Model	7	8	9	10	11	12	13	14	15	16	17	18
W3D1548 L or R	1227	1477	1505	1565	1579	1610	1676	1684	1752	1801	1879	1954
W3D1848 L or R	1310	1572	1602	1666	1682	1714	1784	1794	1867	1917	1999	2078
W3D2448 L or R	1514	1824	1859	1932	1950	1987	2068	2079	2165	2222	2315	2409
W3D1551 L or R	1297	1551	1581	1646	1660	1693	1760	1769	1842	1894	1973	2052
W3D1851 L or R	1389	1652	1685	1752	1768	1803	1874	1886	1961	2014	2100	2184
W3D2451 L or R	1617	1926	1966	2043	2060	2102	2185	2200	2291	2351	2446	2545
W3D1554 L or R	1366	1626	1657	1725	1741	1776	1845	1853	1930	1985	2067	2149
W3D1854 L or R	1465	1733	1768	1839	1853	1893	1965	1977	2057	2114	2203	2291
W3D2454 L or R	1718	2031	2073	2154	2173	2216	2303	2317	2415	2478	2581	2683
W3D1557 L or R	1484	1769	1801	1875	1893	1930	2007	2013	2099	2159	2249	2337
W3D1857 L or R	1595	1885	1922	2001	2013	2057	2138	2149	2236	2299	2393	2489
W3D2457 L or R	1867	2208	2255	2344	2361	2412	2506	2520	2623	2694	2809	2918
W3D1560 L or R	1523	1782	1815	1889	1902	1943	2021	2032	2116	2175	2263	2353
W3D1860 L or R	1620	1894	1930	2007	2026	2065	2148	2157	2248	2310	2408	2503
W3D2460 L or R	1924	2242	2288	2379	2401	2446	2545	2558	2665	2735	2850	2965

**Custom Modifications**

ADDTK	AUTHL AUTHR	CBO	CCO	CFNTO	CFRMO	CND	EXBKL EXBKR	EXL EXR	FB	FFDL FFDR	FPEB	ID	INVRM	MIP	P	PFINBTMB	RD	TD	TVRAV TVRFV TVRVV	WLI
•	•	•	•		•	•	•	•	•		•	•		•						•

**Construction Upgrades**

APC	PE
•	•

**Door Options**

ALF	CG	CG.BTM	CG.TOP	DPSRR	MD	MD.BTM	MD.TOP	MFO
•				•	•			•

W3D2448	1596	1918	1957	2036	2051	2092	2177	2188	2278	2338	2436	2534
W3D2451	1702	2028	2070	2151	2170	2213	2301	2314	2411	2474	2579	2679
W3D2454	1807	2138	2181	2267	2287	2333	2425	2438	2539	2609	2717	2824
W3D2457	1965	2326	2373	2467	2484	2537	2637	2652	2764	2837	2954	3072
W3D2460	2026	2359	2409	2505	2527	2578	2679	2692	2806	2879	3000	3121

**Custom Modifications**

ADDTK	AUTHL AUTHR	CBO	CCO	CFNTO	CFRMO	CND	EXBKL EXBKR	EXL EXR	FB	FFDL FFDR	FPEB	ID	INVRM	MIP	P	PFINBTMB	RD	TD	TVRAV TVRFV TVRVV	WLI
•	•	•	•		•	•	•	•	•		•	•		•						•

**Construction Upgrades**

APC	PE
•	•

**Door Options**

ALF	CG	CG.BTM	CG.TOP	DPSRR	MD	MD.BTM	MD.TOP	MFO
•				•	•			•

**STACKED WALL CABINETS SINGLE DOOR, 48", 51", 54", 57", or 60" HIGH**

12", 15", 18", 21", or 24"

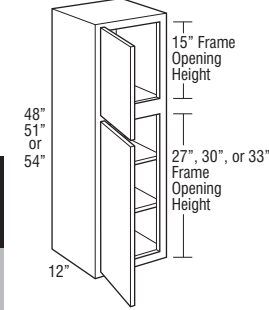

12", 15", 18", 21", or 24"

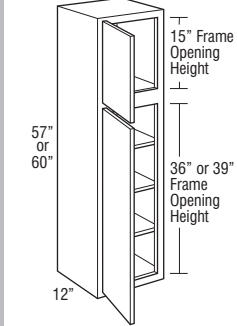

Model	1	2	3	4	5	6
STW1248 L or R	984	1027	1132	1245	1309	1355
STW1548 L or R	1018	1066	1171	1315	1354	1403
STW1848 L or R	1057	1102	1229	1378	1427	1480
STW2148 L or R	1105	1164	1289	1447	1508	1564
STW2448 L or R	1162	1221	1355	1524	1608	1649
STW1251 L or R	1026	1073	1181	1299	1370	1419
STW1551 L or R	1064	1115	1225	1373	1419	1469
STW1851 L or R	1105	1155	1287	1445	1496	1551
STW2151 L or R	1158	1217	1347	1516	1582	1642
STW2451 L or R	1218	1281	1426	1606	1689	1735
STW1254 L or R	1068	1116	1229	1354	1428	1479
STW1554 L or R	1110	1163	1280	1429	1480	1534
STW1854 L or R	1154	1207	1344	1507	1564	1622
STW2154 L or R	1209	1270	1405	1589	1655	1719
STW2454 L or R	1274	1342	1495	1689	1767	1819
STW1257 L or R	1111	1162	1280	1410	1490	1544
STW1557 L or R	1153	1211	1334	1491	1545	1599
STW1857 L or R	1200	1256	1399	1573	1633	1693
STW2157 L or R	1258	1324	1467	1658	1729	1797
STW2457 L or R	1333	1401	1564	1769	1852	1908
STW1260 L or R	1150	1207	1333	1464	1551	1609
STW1560 L or R	1198	1259	1391	1564	1603	1668
STW1860 L or R	1250	1311	1456	1640	1696	1761
STW2160 L or R	1311	1382	1529	1731	1800	1874
STW2460 L or R	1389	1463	1634	1850	1925	1998

• Bottom doors will always be square.

Model	7	8	9	10	11	12	13	14	15	16	17	18
STW1248 L or R	1368	1420	1442	1488	1495	1493	1571	1575	1627	1679	1734	1802
STW1548 L or R	1447	1471	1493	1541	1553	1575	1628	1634	1687	1725	1784	1855
STW1848 L or R	1515	1551	1576	1628	1639	1664	1719	1727	1785	1827	1887	1961
STW2148 L or R	1593	1639	1667	1720	1733	1760	1818	1827	1889	1932	2000	2079
STW2448 L or R	1679	1729	1756	1812	1829	1858	1919	1927	1997	2042	2114	2200

STW1251 L or R	1428	1484	1507	1554	1564	1576	1642	1650	1705	1750	1808	1883
STW1551 L or R	1509	1541	1562	1613	1627	1650	1707	1712	1769	1807	1869	1947
STW1851 L or R	1588	1626	1654	1708	1718	1747	1804	1810	1873	1917	1982	2061
STW2151 L or R	1669	1720	1749	1806	1818	1851	1911	1918	1985	2034	2103	2188
STW2451 L or R	1768	1819	1851	1910	1925	1958	2023	2032	2102	2153	2230	2319

STW1254 L or R	1491	1549	1573	1624	1634	1660	1715	1724	1783	1824	1885	1959
STW1554 L or R	1573	1606	1632	1686	1699	1724	1784	1791	1851	1892	1956	2035
STW1854 L or R	1658	1699	1729	1786	1797	1831	1889	1896	1961	2008	2078	2160
STW2154 L or R	1747	1802	1832	1893	1906	1940	2003	2009	2082	2132	2208	2298
STW2454 L or R	1857	1910	1944	2006	2023	2058	2126	2134	2210	2265	2346	2439

STW1257 L or R	1552	1617	1642	1696	1705	1735	1793	1800	1861	1906	1971	2049
STW1557 L or R	1640	1679	1703	1760	1776	1800	1861	1869	1932	1975	2045	2127
STW1857 L or R	1731	1776	1805	1865	1879	1912	1975	1982	2052	2100	2175	2260
STW2157 L or R	1825	1886	1914	1979	1994	2029	2096	2102	2179	2233	2313	2405
STW2457 L or R	1947	2004	2038	2103	2122	2160	2230	2242	2320	2379	2465	2562

STW1260 L or R	1609	1690	1717	1776	1787	1813	1879	1886	1950	1997	2062	2146
STW1560 L or R	1721	1748	1780	1836	1852	1879	1944	1953	2021	2064	2136	2220
STW1860 L or R	1804	1849	1882	1943	1955	1990	2054	2062	2138	2185	2263	2353
STW2160 L or R	1902	1968	2002	2068	2085	2123	2191	2202	2278	2334	2418	2513
STW2460 L or R	2035	2097	2132	2205	2220	2262	2336	2349	2432	2491	2582	2684

**Custom Modifications**

ADTK	AUTHL AUTHR	CBO	CCO	CFNTO	CFRMO	CND	EXBKL EXBKR	EXL EXR	FB	FFDL FFDR	FPEB	ID	INVRM	MIP	P	PFINBTMB	RD	TD	TVRAV TVRFV TVRVV	WLI
•	•	•	•	•	•	•	•	•	•	•	•	•	•	•	•	•	•	•	•	•

**Construction Upgrades**

APC	PE
•	•

**Door Options**

ALF	CG	CG.BTM	CG.TOP	DPSRR	MD	MD.BTM	MD.TOP	MFO
•	•	•	•	•	•	• <sup>†</sup>	• <sup>†</sup>	•

<sup>†</sup>Not available on 12", 21", and 24" wide

**STACKED WALL CABINETS DOUBLE DOOR, 48", 51", 54", 57", or 60" HIGH**

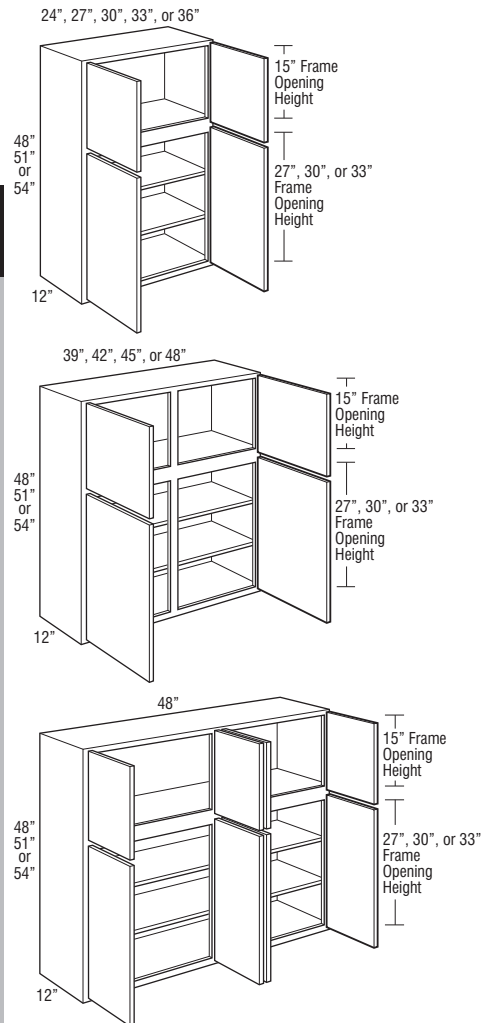

Model	1	2	3	4	5	6
STW2448	1215	1279	1425	1603	1710	1733
STW2748	1256	1322	1476	1661	1724	1802
STW3048	1299	1370	1525	1718	1777	1857
STW3348	1334	1400	1588	1792	1856	1944
STW3648	1368	1439	1626	1844	1911	1995

STW2451	1278	1346	1504	1696	1795	1829
STW2751	1325	1393	1559	1757	1825	1906
STW3051	1373	1447	1609	1816	1883	1966
STW3351	1410	1482	1676	1895	1965	2056
STW3651	1449	1525	1720	1950	2025	2112

STW2454	1342	1414	1583	1789	1877	1921
STW2754	1391	1463	1644	1855	1922	2007
STW3054	1446	1521	1694	1917	1986	2075
STW3354	1488	1563	1762	1999	2074	2168
STW3654	1529	1614	1812	2055	2138	2231

STW3948	1404	1477	1680	1899	1972	2061
STW4248	1431	1505	1741	1971	2048	2139
STW4548	1525	1605	1859	2109	2208	2287
STW4848CS	1621	1707	1980	2248	2367	2433

STW3951	1500	1578	1789	2025	2101	2199
STW4251	1523	1604	1835	2079	2160	2258
STW4551	1627	1716	1964	2229	2331	2420
STW4851CS	1731	1827	2093	2379	2501	2582

STW3954	1595	1680	1897	2149	2231	2333
STW4254	1617	1704	1927	2187	2273	2377
STW4554	1728	1825	2065	2347	2454	2553
STW4854CS	1839	1944	2205	2508	2636	2727

STW4848	1808	1907	2219	2526	2683	2726
---------	------	------	------	------	------	------

STW4851	1936	2045	2352	2676	2841	2902
---------	------	------	------	------	------	------

STW4854	2061	2183	2481	2828	2998	3078
---------	------	------	------	------	------	------

• Bottom doors will always be square.

Model	7	8	9	10	11	12	13	14	15	16	17	18
STW2448	1765	1816	1849	1908	1922	1957	2019	2031	2100	2151	2228	2316
STW2748	1830	1894	1924	1990	2004	2039	2108	2118	2190	2244	2326	2418
STW3048	1889	1952	1982	2051	2067	2100	2174	2179	2257	2313	2395	2492
STW3348	1970	2040	2075	2146	2162	2200	2274	2286	2367	2422	2511	2612
STW3648	2029	2093	2130	2206	2220	2257	2336	2347	2432	2485	2579	2681

STW2451	1865	1917	1952	2013	2029	2067	2133	2146	2219	2274	2355	2449
STW2751	1935	2001	2035	2104	2119	2156	2231	2241	2319	2376	2463	2560
STW3051	2001	2065	2099	2175	2189	2226	2303	2311	2393	2453	2542	2644
STW3351	2085	2159	2198	2273	2292	2330	2413	2422	2510	2567	2664	2769
STW3651	2146	2218	2258	2337	2356	2393	2480	2489	2581	2640	2736	2847

STW2454	1966	2015	2055	2122	2138	2178	2248	2259	2338	2395	2482	2583
STW2754	2041	2105	2144	2218	2233	2273	2353	2362	2447	2507	2596	2701
STW3054	2109	2180	2216	2296	2311	2352	2433	2442	2531	2593	2690	2795
STW3354	2199	2278	2318	2402	2419	2463	2549	2560	2652	2713	2815	2927
STW3654	2260	2345	2384	2470	2489	2530	2622	2633	2727	2792	2897	3013

STW3948	2089	2170	2207	2284	2301	2336	2418	2432	2521	2576	2669	2775
STW4248	2168	2249	2289	2367	2385	2428	2514	2523	2614	2677	2777	2887
STW4548	2320	2405	2446	2533	2553	2597	2690	2701	2799	2869	2974	3093
STW4848CS	2473	2561	2606	2697	2717	2767	2866	2877	2984	3057	3172	3298

STW3951	2228	2313	2353	2435	2454	2493	2583	2595	2691	2751	2850	2966
STW4251	2288	2373	2415	2498	2519	2563	2656	2667	2764	2829	2936	3053
STW4551	2452	2543	2589	2680	2702	2751	2850	2861	2967	3038	3152	3278
STW4851CS	2617	2715	2763	2861	2884	2936	3044	3055	3169	3247	3370	3505

STW3954	2364	2456	2497	2586	2608	2648	2744	2761	2861	2926	3031	3154
STW4254	2408	2496	2539	2629	2651	2697	2794	2810	2912	2981	3093	3219
STW4554	2584	2683	2730	2826	2851	2901	3006	3021	3132	3208	3331	3463
STW4854CS	2760	2870	2919	3023	3050	3104	3218	3231	3353	3434	3565	3709

STW4848	2778	2873	2921	3026	3050	3105	3216	3230	3351	3435	3567	3709
---------	------	------	------	------	------	------	------	------	------	------	------	------

STW4851	2945	3056	3110	3224	3249	3307	3427	3443	3572	3660	3803	3953
---------	------	------	------	------	------	------	------	------	------	------	------	------

STW4854	3112	3241	3299	3419	3447	3509	3638	3654	3794	3887	4036	4198
---------	------	------	------	------	------	------	------	------	------	------	------	------

**Custom Modifications**

ADDTK	AUTHL AUTHR	CBO	CCO	CFNTO	CFRMO	CND	EXBKL EXBKR	EXL EXR	FB	FFDL FFDR	FPEB	ID	INVRM	MIP	P	PFINBTMB	RD	TD	TVRAV TVRFV TVRVV	WLI
•	•	•	•	•	•	•	•	•	•	•	•	•	•	•	•*	•	•	•*	•	•

\*Not available on 39", 42", 45", and 48" wide

**Construction Upgrades**

APC	PE
•	•

**Door Options**

ALF	CG	CG.BTM	CG.TOP	DPSRR	MD	MD.BTM	MD.TOP	MFO
•	•	•	•	•	•	•	•	•

†Available only on 30" and 36" wide

**STACKED WALL CABINETS DOUBLE DOOR, 48", 51", 54", 57", or 60" HIGH (cont'd)**

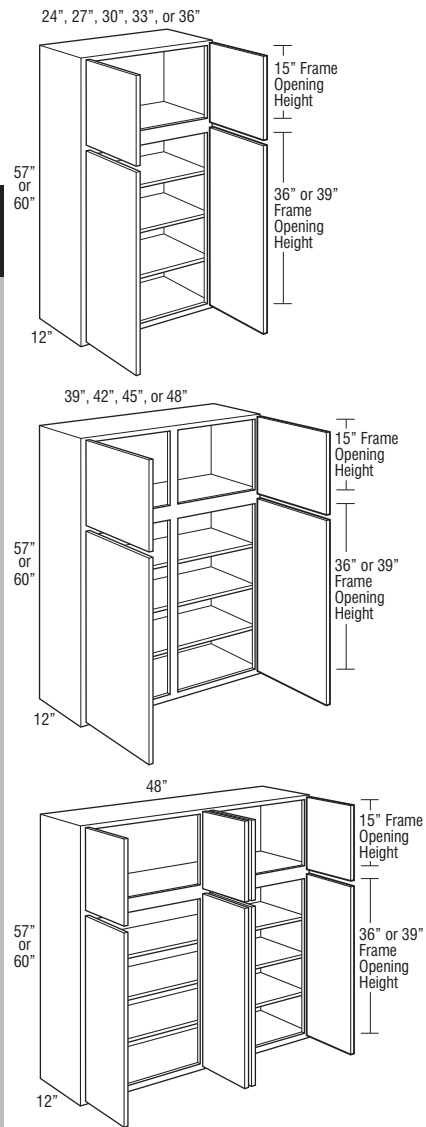

Model	1	2	3	4	5	6
STW2457	1404	1480	1661	1879	1973	2016
STW2757	1457	1535	1727	1952	2023	2112
STW3057	1515	1598	1782	2015	2091	2183
STW3357	1559	1641	1853	2101	2182	2284
STW3657	1605	1696	1908	2163	2252	2351
STW2460	1464	1546	1738	1966	2049	2118
STW2760	1522	1603	1807	2043	2119	2217
STW3060	1596	1682	1861	2114	2191	2295
STW3360	1634	1721	1943	2201	2291	2403
STW3660	1699	1792	2003	2265	2366	2473
STW3957	1676	1766	1998	2265	2352	2462
STW4257	1698	1793	2029	2304	2394	2505
STW4557	1816	1921	2177	2476	2588	2692
STW4857CS	1936	2047	2325	2646	2780	2879
STW3960	1776	1865	2093	2373	2473	2590
STW4260	1799	1894	2128	2414	2520	2634
STW4560	1928	2031	2285	2594	2724	2833
STW4860CS	2056	2166	2440	2774	2927	3030
STW4857	2175	2303	2619	2988	3164	3253
STW4860	2311	2439	2756	3137	3334	3430

• Bottom doors will always be square.

Model	7	8	9	10	11	12	13	14	15	16	17	18
STW2457	2065	2122	2160	2230	2249	2292	2363	2378	2464	2523	2614	2720
STW2757	2146	2217	2258	2336	2353	2394	2479	2488	2582	2642	2737	2848
STW3057	2218	2298	2335	2419	2435	2478	2564	2578	2670	2735	2838	2950
STW3357	2313	2402	2441	2531	2549	2594	2686	2699	2795	2861	2968	3088
STW3657	2381	2471	2513	2605	2624	2669	2767	2775	2878	2947	3056	3179
STW2460	2163	2224	2264	2339	2359	2401	2480	2493	2584	2647	2744	2854
STW2760	2249	2331	2373	2453	2476	2519	2609	2617	2713	2782	2884	3000
STW3060	2326	2415	2453	2542	2561	2608	2697	2710	2810	2877	2986	3104
STW3360	2420	2527	2569	2663	2683	2731	2828	2840	2945	3018	3131	3256
STW3660	2491	2604	2646	2742	2765	2811	2913	2925	3031	3104	3224	3352
STW3957	2491	2589	2635	2727	2751	2794	2898	2913	3021	3090	3203	3333
STW4257	2534	2633	2679	2772	2794	2847	2948	2963	3072	3145	3265	3397
STW4557	2722	2830	2882	2984	3007	3063	3174	3189	3308	3387	3517	3658
STW4857CS	2911	3028	3083	3194	3221	3278	3399	3413	3544	3630	3769	3920
STW3960	2610	2726	2777	2876	2897	2945	3052	3071	3188	3258	3380	3514
STW4260	2654	2772	2822	2923	2945	2997	3105	3120	3238	3315	3443	3581
STW4560	2853	2984	3038	3146	3171	3226	3345	3361	3489	3572	3711	3859
STW4860CS	3052	3195	3253	3370	3397	3457	3583	3602	3740	3831	3979	4137
STW4857	3289	3426	3487	3612	3645	3710	3849	3864	4014	4112	4271	4441
STW4860	3450	3615	3684	3816	3848	3917	4061	4084	4240	4343	4513	4691

**Custom Modifications**

ADTK	AUTHL AUTHR	CBO	CCO	CFNTO	CFRMO	CND	EXBKL EXBKR	EXL EXR	FB	FFDL FFDR	FPEB	ID	INVRM	MIP	P	PFINBTMB	RD	TD	TVRAV TVRFV TVRVV	WLI
•	•	•	•	•	•	•	•	•	•	•	•	•	•	•	•*	•	•	•*	•	•

\*Not available on 39", 42", 45", and 48" wide

**Construction Upgrades**

APC	PE
•	•

**Door Options**

ALF	CG	CG.BTM	CG.TOP	DPSRR	MD	MD.BTM	MD.TOP	MFO
•	•	•	•	•	•	•†	•†	•

†Available only on 30" and 36" wide



**Wall Corner Cabinets**

- Wall corner cabinets may be installed flush to the wall (left) or pulled up to 3" away from wall (right) to accommodate odd dimensions in a kitchen design. In either case, the adjoining run of 12" wall cabinets plus a 3" filler will butt against the solid-wood panel.
- When a cabinet is "pulled" it will use proportionally more wall space, for example, a 30" wide WC pulled 2" will use 32" of space.
- The L or R in the cabinet's nomenclature indicates the location of cabinet void.
- Blind side of wall corner cabinets cannot be installed next to a range hood or microwave shelf unit due to door interference.

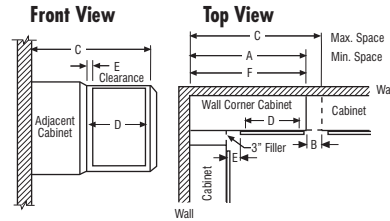

NOTE: All outside stiles are 1 1/2" wide

**WALL CORNER SINGLE DOOR, 24" or 27" HIGH**

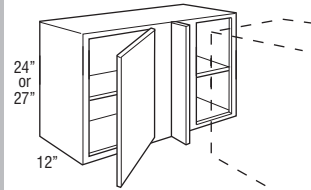

Model	1	2	3	4	5	6
WC2424 L or R	410	431	465	514	529	556
WC2724 L or R	427	452	493	557	576	603
WC3024 L or R	443	468	521	601	618	650
<b>NEW</b> WC2427 L or R	441	465	500	551	571	598
<b>NEW</b> WC2727 L or R	460	487	531	600	621	652
<b>NEW</b> WC3027 L or R	479	505	562	649	667	703

- Includes one 3" filler, shipped unattached.
- L or R indicates void. R (right) void shown.

Model	A Min. Space	B Max. Pull*	C Max. Space	D Cabinet Opening	E* Full Overlay At Min. At Max.		E Partial Overlay At Min. At Max.		F Actual Cabinet
WC24../STWC24..	24"	5"	29"	7 1/2"	1 3/4"	6 3/4"	2 1/2"	7 1/2"	24"
WC27../STWC27..	27"	4 1/2"	31 1/2"	9"	3 1/4"	7 3/4"	4"	8 1/2"	27"
WC30../STWC30..	30"	5"	35"	13 1/2"	1 3/4"	6 3/4"	2 1/2"	7 1/2"	30"
WC33../STWC33..	33"	4 1/2"	37 1/2"	15"	3 1/4"	7 3/4"	4"	8 1/2"	33"
WC36../STWC36..	36"	5"	41"	19 1/2"	1 3/4"	6 3/4"	2 1/2"	7 1/2"	36"
WC39../STWC39..	39"	4 1/2"	43 1/2"	21"	3 1/4"	7 3/4"	4"	8 1/2"	39"
WC42../STWC42..	42"	4 1/2"	46 1/2"	24"	3 1/4"	7 3/4"	4"	8 1/2"	42"
WC45../STWC45..	45"	4 1/2"	49 1/2"	27"	3 1/4"	7 3/4"	4"	8 1/2"	45"
WC48../STWC48..	48"	4 1/2"	52 1/2"	30"	3 1/4"	7 3/4"	4"	8 1/2"	48"

\*Minimum/maximum space between inside edge of door and face of filler/adjoining cabinet. If cabinet is pulled to maximum stated dimension, filler will need to be cleated for proper attachment.

Model	7	8	9	10	11	12	13	14	15	16	17	18
WC2424 L or R	564	588	600	621	631	643	668	669	699	718	748	779
WC2724 L or R	614	639	651	678	684	697	726	728	758	779	811	842
WC3024 L or R	661	688	703	731	737	753	784	786	819	841	877	913
WC2427 L or R	605	634	647	670	679	693	718	723	754	773	806	838
WC2727 L or R	661	691	704	733	739	753	783	787	820	843	875	911
WC3027 L or R	713	743	759	788	796	812	846	849	884	908	946	983

**Custom Modifications**

ADDTK	AUTHL AUTHR	CBO	CCO	CFNTO	CFRMO	CND	EXBKL EXBKR	EXL EXR	FB	FFDL FFDR	FPEB	ID	INVFRM	MIP	P	PFINBTMB	RD	TD	TVRAV TVRFV TVRVV	WLI
•	•	•	•	•	•		•	•	•	•*	•	•		•	•	•	•			•

\*Face Frame and Door on End modification not available on the void side of the cabinet.

**Construction Upgrades**

APC	PE
•	•

**Door Options**

ALF	CG	CG.BTM	CG.TOP	DPSRR	MD	MD.BTM	MD.TOP	MFO
•				•				•

**WALL CORNER SINGLE DOOR,  
30", 33", or 36" HIGH**

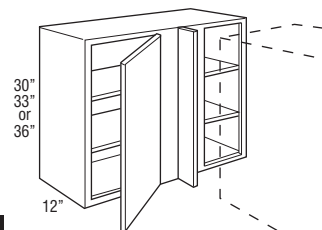

Model	1	2	3	4	5	6
WC2430 L or R	471	499	534	588	613	640
WC2730 L or R	492	521	569	643	666	700
WC3030 L or R	514	541	602	696	716	755
WC3330 L or R	529	561	633	733	758	794
WC3630 L or R	547	578	664	766	797	832
WC2433 L or R	531	562	605	663	687	719
WC2733 L or R	554	586	638	721	748	784
WC3033 L or R	580	613	676	780	808	845
WC3333 L or R	599	634	711	821	853	891
WC3633 L or R	620	657	747	863	893	933
WC2436 L or R	589	627	677	736	762	797
WC2736 L or R	616	653	710	798	831	868
WC3036 L or R	644	682	748	864	897	936
WC3336 L or R	668	708	789	910	946	988
WC3636 L or R	693	734	830	957	991	1036

- Includes one 3" filler, shipped unattached.
- L or R indicates void. R (right) void shown.

**WALL CORNER DOUBLE DOOR,  
30", 33", or 36" HIGH**

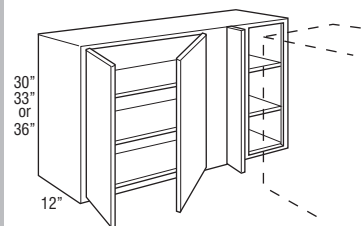

WC3930 L or R	666	702	795	909	954	950
WC4230 L or R	693	733	836	961	1009	1057
WC4530 L or R	715	756	865	996	1041	1091
WC4830 L or R	736	779	892	1034	1074	1125
WC3933 L or R	713	755	860	992	1028	1074
WC4233 L or R	748	792	903	1041	1079	1127
WC4533 L or R	786	832	947	1093	1133	1183
WC4833 L or R	826	874	994	1148	1189	1244
WC3936 L or R	796	843	955	1100	1139	1192
WC4236 L or R	836	885	1003	1156	1197	1252
WC4536 L or R	878	929	1053	1213	1256	1314
WC4836 L or R	922	975	1105	1273	1319	1380

- Includes one 3" filler, shipped unattached.
- L or R indicates void. R (right) void shown.
- On 39" wide cabinets, Peninsula and Mullion Door options cannot be ordered together due to the unavailability of Mullion Doors for the double door side.

Model	7	8	9	10	11	12	13	14	15	16	17	18
WC2430 L or R	646	679	693	719	727	742	768	776	808	828	864	896
WC2730 L or R	708	743	757	787	793	809	839	845	881	906	939	979
WC3030 L or R	765	798	814	844	855	871	908	911	949	974	1015	1053
WC3330 L or R	807	840	862	892	904	918	957	962	1000	1027	1069	1112
WC3630 L or R	842	881	904	936	943	963	1001	1009	1050	1080	1124	1169

WC2433 L or R	729	762	779	809	815	832	865	870	907	929	967	1007
WC2733 L or R	793	831	846	880	888	907	939	947	987	1014	1053	1097
WC3033 L or R	860	894	914	949	960	978	1018	1021	1065	1093	1138	1183
WC3333 L or R	905	942	964	1001	1013	1030	1072	1077	1123	1152	1200	1248
WC3633 L or R	946	989	1014	1051	1060	1081	1124	1132	1178	1211	1260	1310

WC2436 L or R	811	843	864	896	906	921	959	964	1005	1029	1072	1114
WC2736 L or R	879	918	936	974	984	1001	1042	1048	1091	1121	1168	1215
WC3036 L or R	949	992	1013	1052	1062	1084	1128	1133	1179	1213	1262	1311
WC3336 L or R	999	1046	1066	1111	1121	1140	1187	1194	1245	1275	1330	1384
WC3636 L or R	1050	1097	1123	1166	1175	1199	1247	1253	1305	1340	1395	1451

**Custom Modifications**

ADDTK	AUTHL AUTHR	CBO	CCO	CFNTD	CFRMO	CND	EXBKL EXBKR	EXL EXR	FB	FFDL FFDR	FPEB	ID	INVRM	MIP	P	PFINBTMB	RD	TD	TVRAV TVRFV TVRVV	WLI
•	•	•	•	•	•	•	•	•	•	•*	•	•	•	•	•	•	•	•	•	•

\*Face Frame and Door on End modification not available on the void side of the cabinet.

**Construction Upgrades**

APC	PE
•	•

**Door Options**

ALF	CG	CG.BTM	CG.TOP	DPSRR	MD	MD.BTM	MD.TOP	MFO
•	•	•	•	•	• <sup>1</sup>	•	•	•

<sup>1</sup>Available only on 33" and 36" wide

WC3930 L or R	998	1008	1026	1066	1078	1097	1141	1146	1195	1227	1279	1331
WC4230 L or R	1056	1121	1140	1187	1198	1220	1270	1275	1330	1366	1423	1479
WC4530 L or R	1097	1157	1178	1225	1237	1260	1310	1316	1372	1408	1467	1525
WC4830 L or R	1136	1189	1215	1263	1274	1299	1349	1356	1414	1451	1512	1573

WC3933 L or R	1088	1137	1166	1209	1219	1244	1293	1302	1355	1393	1450	1507
WC4233 L or R	1142	1195	1224	1269	1280	1305	1357	1367	1423	1463	1521	1583
WC4533 L or R	1201	1254	1286	1333	1344	1370	1425	1435	1495	1537	1598	1662
WC4833 L or R	1260	1316	1350	1400	1411	1438	1497	1507	1568	1613	1678	1745

WC3936 L or R	1207	1261	1292	1341	1351	1378	1433	1441	1501	1541	1604	1668
WC4236 L or R	1267	1324	1356	1408	1419	1448	1506	1513	1576	1618	1685	1752
WC4536 L or R	1331	1390	1424	1477	1491	1519	1582	1589	1655	1699	1769	1840
WC4836 L or R	1398	1459	1496	1552	1564	1596	1661	1668	1738	1784	1858	1932

**Custom Modifications**

ADDTK	AUTHL AUTHR	CBO	CCO	CFNTD	CFRMO	CND	EXBKL EXBKR	EXL EXR	FB	FFDL FFDR	FPEB	ID	INVRM	MIP	P	PFINBTMB	RD	TD	TVRAV TVRFV TVRVV	WLI
•	•	•	•	•	•	•	•	•	•	•*	•	•	•	•	•	•	•	•	•	•

\*Face Frame and Door on End modification not available on the void side of the cabinet.

**Construction Upgrades**

APC	PE
•	•

**Door Options**

ALF	CG	CG.BTM	CG.TOP	DPSRR	MD	MD.BTM	MD.TOP	MFO
•	•	•	•	•	•	•	•	•

**WALL CORNER SINGLE DOOR, 39" or 42" HIGH**

24", 27", 30", 33", or 36"

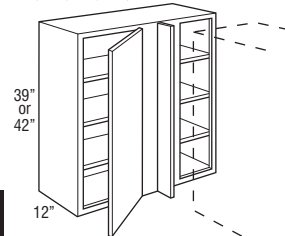

Model	1	2	3	4	5	6
WC2439 L or R	650	689	744	811	837	878
WC2739 L or R	678	719	782	879	914	956
WC3039 L or R	709	751	823	949	988	1031
WC3339 L or R	735	779	869	999	1041	1086
WC3639 L or R	763	808	913	1050	1091	1138
WC2442 L or R	710	753	819	889	915	959
WC2742 L or R	748	792	862	961	993	1040
WC3042 L or R	784	827	897	1031	1075	1124
WC3342 L or R	811	862	949	1087	1133	1183
WC3642 L or R	840	889	994	1141	1188	1243

- Includes one 3" filler, shipped unattached.
- L or R indicates void. R (right) void shown.

**WALL CORNER DOUBLE DOOR, 39" or 42" HIGH**

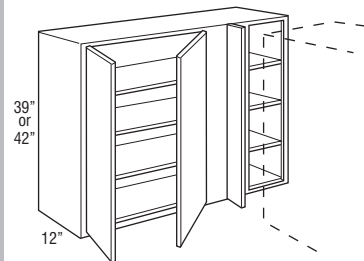

WC3939 L or R	877	929	1050	1207	1255	1309
WC4239 L or R	921	975	1102	1267	1317	1375
WC4539 L or R	967	1024	1158	1331	1383	1445
WC4839 L or R	1015	1076	1215	1398	1453	1516
WC3942 L or R	966	1023	1144	1313	1367	1428
WC4242 L or R	1014	1075	1202	1379	1435	1500
WC4542 L or R	1064	1128	1261	1449	1507	1575
WC4842 L or R	1118	1184	1324	1520	1583	1654

- Includes one 3" filler, shipped unattached.
- L or R indicates void. R (right) void shown.
- On 39" wide cabinets, Peninsula and Mullion Door options cannot be ordered together due to the unavailability of Mullion Doors for the double door side.

Model	7	8	9	10	11	12	13	14	15	16	17	18
WC2439 L or R	891	928	949	987	993	1014	1052	1059	1103	1132	1176	1224
WC2739 L or R	967	1009	1031	1073	1082	1101	1146	1154	1201	1231	1285	1336
WC3039 L or R	1043	1092	1114	1161	1168	1192	1242	1247	1298	1334	1389	1445
WC3339 L or R	1099	1150	1172	1220	1231	1255	1306	1313	1368	1403	1462	1520
WC3639 L or R	1157	1207	1233	1283	1294	1319	1371	1378	1436	1473	1537	1597
WC2442 L or R	980	1015	1036	1078	1086	1107	1153	1161	1209	1239	1290	1341
WC2742 L or R	1056	1102	1128	1170	1181	1204	1254	1260	1313	1346	1401	1458
WC3042 L or R	1134	1188	1214	1262	1273	1297	1348	1355	1413	1450	1511	1572
WC3342 L or R	1197	1255	1279	1331	1342	1370	1424	1431	1492	1530	1595	1657
WC3642 L or R	1256	1316	1342	1396	1406	1437	1493	1502	1564	1604	1674	1741

**Custom Modifications**

ADDTK	AUTHL AUTHR	CBO	CCO	CFNTO	CFRMO	CND	EXBKL EXBKR	EXL EXR	FB	FFDL FFDR	FPEB	ID	INVFRM	MIP	P	PFINBTMB	RD	TD	TVRAV TVRFV TVRVV	WLI
•	•	•	•	•	•	•	•	•	•	•*	•	•	•	•	•	•	•	•	•	•

\*Face Frame and Door on End modification not available on the void side of the cabinet.

**Construction Upgrades**

APC	PE
•	•

**Door Options**

ALF	CG	CG.BTM	CG.TOP	DPSRR	MD	MD.BTM	MD.TOP	MFO
•	•	•	•	•	• <sup>†</sup>	•	•	•

<sup>†</sup>Available only on 33" and 36" wide

WC3939 L or R	1330	1388	1419	1475	1488	1516	1577	1586	1651	1694	1766	1837
WC4239 L or R	1397	1457	1491	1550	1561	1592	1656	1665	1734	1780	1854	1929
WC4539 L or R	1467	1530	1564	1627	1640	1671	1739	1749	1821	1868	1948	2025
WC4839 L or R	1541	1606	1643	1709	1721	1755	1826	1837	1912	1961	2045	2127
WC3942 L or R	1445	1514	1543	1605	1616	1652	1716	1727	1799	1845	1926	2001
WC4242 L or R	1516	1590	1620	1686	1697	1735	1802	1813	1889	1937	2022	2101
WC4542 L or R	1592	1669	1701	1770	1782	1822	1892	1905	1983	2035	2124	2206
WC4842 L or R	1671	1753	1786	1859	1870	1913	1986	2000	2083	2136	2229	2316

**Custom Modifications**

ADDTK	AUTHL AUTHR	CBO	CCO	CFNTO	CFRMO	CND	EXBKL EXBKR	EXL EXR	FB	FFDL FFDR	FPEB	ID	INVFRM	MIP	P	PFINBTMB	RD	TD	TVRAV TVRFV TVRVV	WLI
•	•	•	•	•	•	•	•	•	•	•*	•	•	•	•	•	•	•	•	•	•

\*Face Frame and Door on End modification not available on the void side of the cabinet.

**Construction Upgrades**

APC	PE
•	•

**Door Options**

ALF	CG	CG.BTM	CG.TOP	DPSRR	MD	MD.BTM	MD.TOP	MFO
•	•	•	•	•	•	•	•	•

**NEW** STACKED WALL CORNER SINGLE DOOR, 48", 51", or 54" HIGH

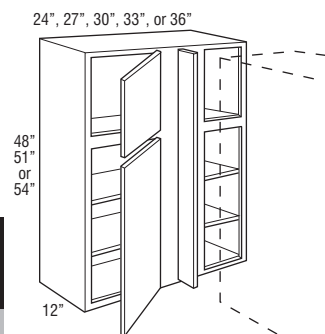

Model	1	2	3	4	5	6
STWC2448 L or R	996	1049	1169	1314	1402	1421
STWC2748 L or R	1042	1097	1225	1379	1431	1496
STWC3048 L or R	1104	1165	1296	1460	1510	1578
STWC3348 L or R	1134	1190	1350	1523	1578	1652
STWC3648 L or R	1190	1252	1415	1604	1663	1736
STWC2451 L or R	1048	1104	1233	1391	1472	1500
STWC2751 L or R	1100	1156	1294	1458	1515	1582
STWC3051 L or R	1167	1230	1368	1544	1601	1671
STWC3351 L or R	1199	1260	1425	1611	1670	1748
STWC3651 L or R	1261	1327	1496	1697	1762	1837
STWC2454 L or R	1100	1159	1298	1467	1539	1575
STWC2754 L or R	1155	1214	1365	1540	1595	1666
STWC3054 L or R	1229	1293	1440	1629	1688	1764
STWC3354 L or R	1265	1329	1498	1699	1763	1843
STWC3654 L or R	1330	1404	1576	1788	1860	1941

- Includes one 3" filler, shipped unattached.
- L or R indicates void. R (right) void shown.

**NEW** STACKED WALL CORNER DOUBLE DOOR, 48", 51", or 54" HIGH

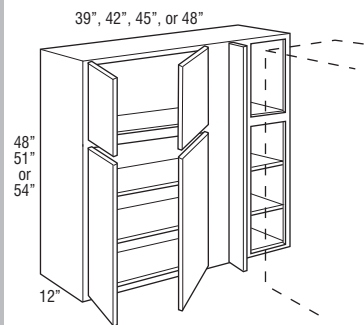

STWC3948 L or R	1320	1388	1579	1785	1854	1937
STWC4248 L or R	1402	1475	1706	1932	2007	2096
STWC4548 L or R	1434	1509	1747	1982	2076	2150
STWC4848 L or R	1663	1754	2041	2324	2468	2508
STWC3951 L or R	1410	1483	1682	1904	1975	2067
STWC4251 L or R	1493	1572	1798	2037	2117	2213
STWC4551 L or R	1529	1613	1846	2095	2191	2275
STWC4851 L or R	1781	1881	2164	2462	2614	2670
STWC3954 L or R	1499	1579	1783	2020	2097	2193
STWC4254 L or R	1585	1670	1888	2143	2228	2329
STWC4554 L or R	1624	1716	1941	2206	2307	2400
STWC4854 L or R	1896	2008	2283	2602	2758	2832

- Includes one 3" filler, shipped unattached.
- L or R indicates void. R (right) void shown.

Model	7	8	9	10	11	12	13	14	15	16	17	18
STWC2448 L or R	1447	1489	1516	1565	1576	1605	1656	1665	1722	1764	1827	1899
STWC2748 L or R	1519	1572	1597	1652	1663	1692	1750	1758	1818	1863	1931	2007
STWC3048 L or R	1606	1659	1685	1743	1757	1785	1848	1852	1918	1966	2036	2118
STWC3348 L or R	1675	1734	1764	1824	1838	1870	1933	1943	2012	2059	2134	2220
STWC3648 L or R	1765	1821	1853	1919	1931	1964	2032	2042	2116	2162	2244	2332
STWC2451 L or R	1529	1572	1601	1651	1664	1695	1749	1760	1820	1865	1931	2008
STWC2751 L or R	1606	1661	1689	1746	1759	1789	1852	1860	1925	1972	2044	2125
STWC3051 L or R	1701	1755	1784	1849	1861	1892	1958	1964	2034	2085	2161	2247
STWC3351 L or R	1772	1835	1868	1932	1948	1981	2051	2059	2134	2182	2264	2354
STWC3651 L or R	1867	1930	1964	2033	2050	2082	2158	2165	2245	2297	2380	2477
STWC2454 L or R	1612	1652	1685	1740	1753	1786	1843	1852	1917	1964	2035	2118
STWC2754 L or R	1694	1747	1780	1841	1853	1887	1953	1960	2031	2081	2155	2242
STWC3054 L or R	1793	1853	1884	1952	1964	1999	2068	2076	2151	2204	2287	2376
STWC3354 L or R	1869	1936	1970	2042	2056	2094	2167	2176	2254	2306	2393	2488
STWC3654 L or R	1966	2040	2074	2149	2165	2201	2281	2291	2372	2429	2520	2621

Custom Modifications

ADTK	AUTHL AUTHR	CBO	CCO	CFNTD	CFRMO	CND	EXBKL EXBKR	EXL EXR	FB	FFDL FFDR	FPEB	ID	INVFRM	MIP	P	PFINBTMB	RD	TD	TVRAV TVRFV TVRVV	WLI
•	•	•	•	•	•	•	•	•	•	•*	•	•	•	•	•	•	•	•	•	•

\*Face Frame and Door on End modification not available on the void side of the cabinet.

Construction Upgrades

APC	PE
•	•

Door Options

ALF	CG	CG.BTM	CG.TOP	DPSRR	MD	MD.BTM	MD.TOP	MFO
•	•	•	•	•	•	•	•	•

STWC3948 L or R	1964	2040	2075	2147	2163	2196	2273	2286	2370	2421	2509	2609
STWC4248 L or R	2125	2204	2243	2320	2337	2379	2464	2473	2562	2623	2721	2829
STWC4548 L or R	2181	2261	2299	2381	2400	2441	2529	2539	2631	2697	2796	2907
STWC4848 L or R	2556	2643	2687	2784	2806	2857	2959	2972	3083	3160	3282	3412
STWC3951 L or R	2094	2174	2212	2289	2307	2343	2428	2439	2530	2586	2679	2788
STWC4251 L or R	2242	2326	2367	2448	2469	2512	2603	2614	2709	2772	2877	2992
STWC4551 L or R	2305	2390	2434	2519	2540	2586	2679	2689	2789	2856	2963	3081
STWC4851 L or R	2709	2812	2861	2966	2989	3042	3153	3168	3286	3367	3499	3637
STWC3954 L or R	2222	2309	2347	2431	2452	2489	2579	2595	2689	2750	2849	2965
STWC4254 L or R	2360	2446	2488	2576	2598	2643	2738	2754	2854	2921	3031	3155
STWC4554 L or R	2429	2522	2566	2656	2680	2727	2826	2840	2944	3016	3131	3255
STWC4854 L or R	2863	2982	3035	3145	3171	3228	3347	3362	3490	3576	3713	3862

Custom Modifications

ADTK	AUTHL AUTHR	CBO	CCO	CFNTD	CFRMO	CND	EXBKL EXBKR	EXL EXR	FB	FFDL FFDR	FPEB	ID	INVFRM	MIP	P	PFINBTMB	RD	TD	TVRAV TVRFV TVRVV	WLI
•	•	•	•	•	•	•	•	•	•	•*	•	•	•	•	•	•	•	•	•	•

\*Face Frame and Door on End modification not available on the void side of the cabinet.

Construction Upgrades

APC	PE
•	•

Door Options

ALF	CG	CG.BTM	CG.TOP	DPSRR	MD	MD.BTM	MD.TOP	MFO
•	•	•	•	•	•	•	•	•

**NEW** STACKED WALL CORNER SINGLE DOOR, 57" or 60" HIGH

24", 27", 30", 33", or 36"

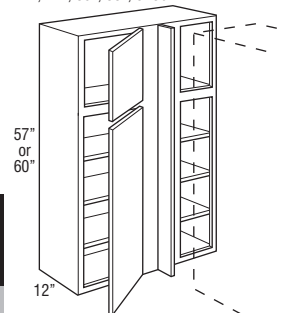

Model	1	2	3	4	5	6
STWC2457 L or R	1151	1214	1362	1541	1618	1653
STWC2757 L or R	1209	1274	1433	1620	1679	1753
STWC3057 L or R	1288	1358	1515	1713	1777	1856
STWC3357 L or R	1325	1395	1575	1786	1855	1941
STWC3657 L or R	1396	1476	1660	1882	1959	2045
STWC2460 L or R	1200	1268	1425	1612	1680	1737
STWC2760 L or R	1263	1330	1500	1696	1759	1840
STWC3060 L or R	1357	1430	1582	1797	1862	1951
STWC3360 L or R	1389	1463	1652	1871	1947	2043
STWC3660 L or R	1478	1559	1743	1971	2058	2152

- Includes one 3" filler, shipped unattached.
- L or R indicates void. R (right) void shown.

**NEW** STACKED WALL CORNER DOUBLE DOOR, 57" or 60" HIGH

39", 42", 45", or 48"

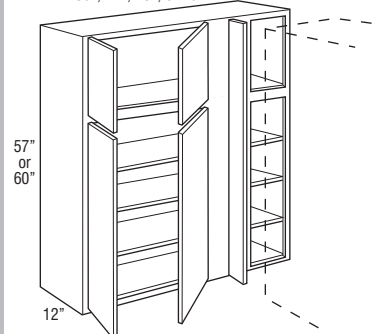

STWC3957 L or R	1575	1660	1878	2129	2211	2314
STWC4257 L or R	1664	1757	1988	2258	2346	2455
STWC4557 L or R	1707	1806	2046	2327	2433	2530
STWC4857 L or R	2001	2119	2409	2749	2911	2993
STWC3960 L or R	1669	1753	1967	2231	2325	2435
STWC4260 L or R	1763	1856	2085	2366	2470	2581
STWC4560 L or R	1812	1909	2148	2438	2561	2663
STWC4860 L or R	2126	2244	2536	2886	3067	3156

- Includes one 3" filler, shipped unattached.
- L or R indicates void. R (right) void shown.

Model	7	8	9	10	11	12	13	14	15	16	17	18
STWC2457 L or R	1693	1740	1771	1829	1844	1879	1938	1950	2020	2069	2143	2230
STWC2757 L or R	1781	1840	1874	1939	1953	1987	2058	2065	2143	2193	2272	2364
STWC3057 L or R	1885	1953	1985	2056	2070	2106	2179	2191	2270	2325	2412	2508
STWC3357 L or R	1966	2042	2075	2151	2167	2205	2283	2294	2376	2432	2523	2625
STWC3657 L or R	2071	2150	2186	2266	2283	2322	2407	2414	2504	2564	2659	2766
STWC2460 L or R	1774	1824	1856	1918	1934	1969	2034	2044	2119	2171	2250	2340
STWC2760 L or R	1867	1935	1970	2036	2055	2091	2165	2172	2252	2309	2394	2490
STWC3060 L or R	1977	2053	2085	2161	2177	2217	2292	2304	2389	2445	2538	2638
STWC3360 L or R	2057	2148	2184	2264	2281	2321	2404	2414	2503	2565	2661	2768
STWC3660 L or R	2167	2265	2302	2386	2406	2446	2534	2545	2637	2700	2805	2916

Custom Modifications

ADDTK	AUTHL AUTHR	CBO	CCO	CFNTO	CFRMO	CND	EXBKL EXBKR	EXL EXR	FB	FFDL FFDR	FPEB	ID	INVFRM	MIP	P	PFINBTMB	RD	TD	TVRAV TVRFV TVRVV	WLI
•	•	•	•	•	•	•	•	•	•	•*	•	•	•	•	•	•	•	•	•	•

\*Face Frame and Door on End modification not available on the void side of the cabinet.

Construction Upgrades

APC	PE
•	•

Door Options

ALF	CG	CG.BTM	CG.TOP	DPSRR	MD	MD.BTM	MD.TOP	MFO
•	•	•	•	•	•	•	•	•

STWC3957 L or R	2342	2434	2477	2563	2586	2626	2724	2738	2840	2905	3011	3133
STWC4257 L or R	2483	2580	2625	2717	2738	2790	2889	2904	3011	3082	3200	3329
STWC4557 L or R	2559	2660	2709	2805	2827	2879	2984	2998	3110	3184	3306	3439
STWC4857 L or R	3026	3152	3208	3323	3353	3413	3541	3555	3693	3783	3929	4086
STWC3960 L or R	2453	2562	2610	2703	2723	2768	2869	2887	2997	3063	3177	3303
STWC4260 L or R	2601	2717	2766	2865	2886	2937	3043	3058	3173	3249	3374	3509
STWC4560 L or R	2682	2805	2856	2957	2981	3032	3144	3159	3280	3358	3488	3627
STWC4860 L or R	3174	3326	3389	3511	3540	3604	3736	3757	3901	3996	4152	4316

Custom Modifications

ADDTK	AUTHL AUTHR	CBO	CCO	CFNTO	CFRMO	CND	EXBKL EXBKR	EXL EXR	FB	FFDL FFDR	FPEB	ID	INVFRM	MIP	P	PFINBTMB	RD	TD	TVRAV TVRFV TVRVV	WLI
•	•	•	•	•	•	•	•	•	•	•*	•	•	•	•	•	•	•	•	•	•

\*Face Frame and Door on End modification not available on the void side of the cabinet.

Construction Upgrades

APC	PE
•	•

Door Options

ALF	CG	CG.BTM	CG.TOP	DPSRR	MD	MD.BTM	MD.TOP	MFO
•	•	•	•	•	•	•	•	•

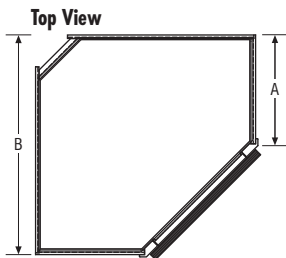

Diagonal Wall Cabinets with Increased or Reduced Depth

	RD9	RD10	RD11	STD	ID13	ID14	ID15	ID16	ID17	ID18	ID19	ID20	ID21	ID22	ID23	ID24	
Cabinet Depth	A	9"	10"	11"	12"	13"	14"	15"	16"	17"	18"	19"	20"	21"	22"	23"	24"
Wall Space	B	21"	22"	23"	24"	25"	26"	27"	28"	29"	30"	31"	32"	33"	34"	35"	36"

DIAGONAL WALL, 12", 15", or 18" HIGH, 24" x 24"

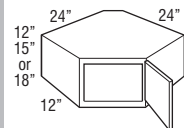

Model	1	2	3	4	5	6
DW122424 L or R	278	297	338	391	408	427
DW152424 L or R	307	330	375	436	454	474
DW182424 L or R	343	367	416	485	504	527

- Cabinets require 24" x 24" of corner wall space.
- Full overlay styles use HINGEQRPO, see page 590.

DIAGONAL WALL, 24" or 27" HIGH, 24" x 24"

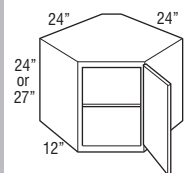

Model	7	8	9	10	11	12
DW242424 L or R	381	407	463	537	560	585
DW272424 L or R	424	453	514	598	623	650

- Cabinets require 24" x 24" of corner wall space.
- Adjustable shelf cannot be removed/retrofitted.
- Full overlay styles use HINGEQRPO, see page 590.

DIAGONAL WALL, 30", 33", 36", 39", or 42" HIGH, 24" x 24"

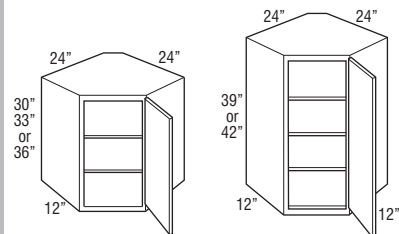

DW302424 L or R	471	502	571	664	692	721
DW332424 L or R	536	574	636	745	780	814
DW362424 L or R	603	643	702	827	867	908
DW392424 L or R	664	708	772	911	954	996
DW422424 L or R	734	782	830	989	1038	1088

- Cabinets require 24" x 24" of corner wall space.
- Adjustable shelves.
- Full overlay styles use HINGEQRPO, see page 590.

DW302424 L or R  
DW332424 L or R  
DW362424 L or R

DW392424 L or R  
DW422424 L or R

Model	7	8	9	10	11	12	13	14	15	16	17	18
DW122424 L or R	432	453	461	482	485	494	515	516	536	553	578	599
DW152424 L or R	479	502	513	534	539	548	573	575	597	615	640	666
DW182424 L or R	533	557	570	592	599	611	635	637	663	682	711	739

Custom Modifications

ADDTK	AUTHL AUTHR	CBO	CCO	CFNTO	CFRMO	CND	EXBKL EXBKR	EXL EXR	FB	FFDL FFDR	FPEB	ID	INVRM	MIP	P	PFINBTMB	RD	TD	TVRAV TVRFV TVRVV	WLI
	•		•	•	•				•	•*	•	•		•		•	•			•

\*Available only on 18" high

Construction Upgrades

APC	PE
•	•

Door Options

ALF	CG	CG.BTM	CG.TOP	DPSRR	MD	MD.BTM	MD.TOP	MFO
	•			•				•

DW242424 L or R	591	620	633	660	666	678	706	708	737	758	790	821
DW272424 L or R	659	689	703	733	739	753	785	787	819	842	878	913

Custom Modifications

ADDTK	AUTHL AUTHR	CBO	CCO	CFNTO	CFRMO	CND	EXBKL EXBKR	EXL EXR	FB	FFDL FFDR	FPEB	ID	INVRM	MIP	P	PFINBTMB	RD	TD	TVRAV TVRFV TVRVV	WLI
	•	•	•	•	•				•	•	•	•		•		•	•			•

Construction Upgrades

APC	PE
•	•

Door Options

ALF	CG	CG.BTM	CG.TOP	DPSRR	MD	MD.BTM	MD.TOP	MFO
	•			•				•

DW302424 L or R	731	765	783	813	821	836	871	874	911	935	975	1015
DW332424 L or R	821	864	881	917	924	942	981	985	1026	1053	1098	1141
DW362424 L or R	911	961	980	1018	1027	1049	1089	1095	1140	1172	1220	1269

DW392424 L or R	1000	1056	1078	1121	1130	1155	1200	1204	1255	1290	1342	1395
DW422424 L or R	1087	1154	1178	1224	1233	1260	1311	1316	1373	1407	1467	1524

Custom Modifications

ADDTK	AUTHL AUTHR	CBO	CCO	CFNTO	CFRMO	CND	EXBKL EXBKR	EXL EXR	FB	FFDL FFDR	FPEB	ID	INVRM	MIP	P	PFINBTMB	RD	TD	TVRAV TVRFV TVRVV	WLI
	•	•	•	•	•				•	•	•	•		•		•	•			•

Construction Upgrades

APC	PE
•	•

Door Options

ALF	CG	CG.BTM	CG.TOP	DPSRR	MD	MD.BTM	MD.TOP	MFO
	•			•	•			•

**DIAGONAL WALL, 12", 15", or 18" HIGH, 27" x 27"**

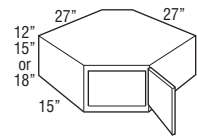

Model	1	2	3	4	5	6
DW122727 L or R	489	513	546	618	639	808
DW152727 L or R	543	570	605	686	710	896
DW182727 L or R	603	633	674	762	789	995

- Cabinets require 27" x 27" of corner wall space.
- Full overlay styles use HINGEQRPO, see page 590.

**DIAGONAL WALL, 24" or 27" HIGH, 27" x 27"**

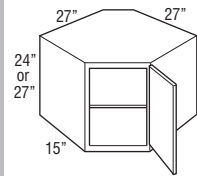

DW242727 L or R	671	703	748	846	877	1107
DW272727 L or R	745	782	832	939	974	1228

- Cabinets require 27" x 27" of corner wall space.
- Adjustable shelf cannot be removed/retrofitted.
- Full overlay styles use HINGEQRPO, see page 590.

**DIAGONAL WALL, 30", 33", 36", 39", or 42" HIGH, 27" x 27"**

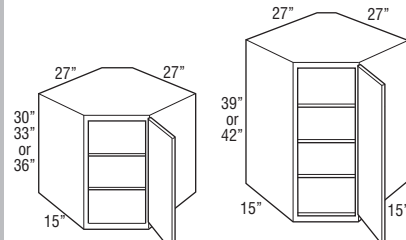

DW302727 L or R  
DW332727 L or R  
DW362727 L or R

DW392727 L or R  
DW422727 L or R

DW302727 L or R	828	868	924	1044	1082	1367
DW332727 L or R	884	927	987	1116	1157	1457
DW362727 L or R	939	986	1049	1187	1228	1549

DW392727 L or R	1035	1084	1155	1306	1351	1703
DW422727 L or R	1085	1136	1188	1363	1416	1749

- Cabinets require 27" x 27" of corner wall space.
- Full overlay styles use HINGEQRPO, see page 590.

**DIAGONAL WALL with LAZY SUSAN, 30", 33", 36", 39", or 42" HIGH, 24" x 24"**

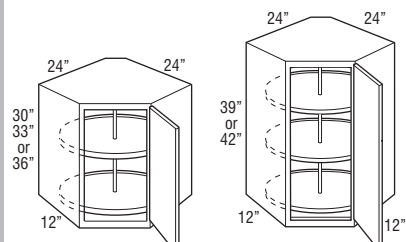

DW302424 L or R  
DW332424 L or R  
DW362424 L or R

DW392424 L or R  
DW422424 L or R

DW302424 L or R	697	745	817	932	990	1035
DW332424 L or R	791	844	904	1043	1107	1155
DW362424 L or R	885	942	987	1153	1222	1275

DW392424 L or R	975	1038	1085	1267	1345	1403
DW422424 L or R	1068	1136	1157	1372	1454	1518

- Cabinets require 24" x 24" of corner wall space.
- Plywood shelves are 18" in overall diameter with a 17" interior diameter and 1" high lip.
- Shelves rotate independently.
- Full overlay styles use HINGEQRPO, see page 590.

Model	7	8	9	10	11	12	13	14	15	16	17	18
DW122727 L or R	680	855	873	908	915	932	1053	1009	1053	1111	1157	1203
DW152727 L or R	756	950	970	1008	1017	1037	1170	1121	1170	1233	1284	1336
DW182727 L or R	839	1055	1078	1119	1131	1153	1300	1247	1300	1371	1426	1484

**Custom Modifications**

ADDTK	AUTHL AUTHR	CBO	CCO	CFNTO	CFRMO	CND	EXBKL EXBKR	EXL EXR	FB	FFDL FFDR	FPEB	ID	INVRM	MIP	P	PFINBTMB	RD	TD	TVRAV TVRFV TVRVV	WLI
	•		•	•	•				•	•*	•	•		•		•	•			•

\*Available only on 18" high

**Construction Upgrades**

APC	PE
•	•

**Door Options**

ALF	CG	CG.BTM	CG.TOP	DPSRR	MD	MD.BTM	MD.TOP	MFO
	•			•				•

DW242727 L or R	931	1171	1198	1246	1255	1280	1446	1385	1446	1522	1584	1649
DW272727 L or R	1035	1303	1330	1382	1394	1423	1605	1540	1605	1692	1760	1832

**Custom Modifications**

ADDTK	AUTHL AUTHR	CBO	CCO	CFNTO	CFRMO	CND	EXBKL EXBKR	EXL EXR	FB	FFDL FFDR	FPEB	ID	INVRM	MIP	P	PFINBTMB	RD	TD	TVRAV TVRFV TVRVV	WLI
	•	•	•	•	•				•	•	•	•		•		•	•			•

**Construction Upgrades**

APC	PE
•	•

**Door Options**

ALF	CG	CG.BTM	CG.TOP	DPSRR	MD	MD.BTM	MD.TOP	MFO
	•			•				•

DW302727 L or R	1149	1448	1478	1538	1549	1581	1784	1710	1784	1881	1956	2035
DW332727 L or R	1227	1546	1577	1640	1654	1687	1906	1829	1906	2007	2090	2174
DW362727 L or R	1306	1642	1678	1745	1756	1794	2026	1945	2026	2133	2222	2311

DW392727 L or R	1437	1806	1844	1918	1935	1972	2229	2139	2229	2347	2444	2542
DW422727 L or R	1499	1853	1893	1965	1983	2024	2301	2208	2301	2435	2536	2638

**Custom Modifications**

ADDTK	AUTHL AUTHR	CBO	CCO	CFNTO	CFRMO	CND	EXBKL EXBKR	EXL EXR	FB	FFDL FFDR	FPEB	ID	INVRM	MIP	P	PFINBTMB	RD	TD	TVRAV TVRFV TVRVV	WLI
	•	•	•	•	•				•	•	•	•		•		•	•			•

**Construction Upgrades**

APC	PE
•	•

**Door Options**

ALF	CG	CG.BTM	CG.TOP	DPSRR	MD	MD.BTM	MD.TOP	MFO
	•			•	•			•

DW302424 L or R	1026	1097	1118	1164	1172	1198	1245	1252	1304	1339	1395	1452
DW332424 L or R	1146	1224	1250	1300	1311	1338	1390	1398	1456	1494	1557	1620
DW362424 L or R	1267	1353	1377	1435	1447	1475	1535	1545	1607	1649	1718	1786

DW392424 L or R	1394	1489	1516	1577	1592	1623	1687	1699	1770	1811	1890	1965
DW422424 L or R	1508	1613	1644	1711	1722	1757	1830	1839	1914	1966	2049	2132

**Custom Modifications**

ADDTK	AUTHL AUTHR	CBO	CCO	CFNTO	CFRMO	CND	EXBKL EXBKR	EXL EXR	FB	FFDL FFDR	FPEB	ID	INVRM	MIP	P	PFINBTMB	RD	TD	TVRAV TVRFV TVRVV	WLI
	•	•	•	•	•				•	•	•	•		•		•	•			•

**Construction Upgrades**

APC	PE
•	•

**Door Options**

ALF	CG	CG.BTM	CG.TOP	DPSRR	MD	MD.BTM	MD.TOP	MFO
	•			•	•			•

**DIAGONAL WALL with LOWER DOOR, 48", 51", 54", 57", or 60" HIGH, 24" x 24"**

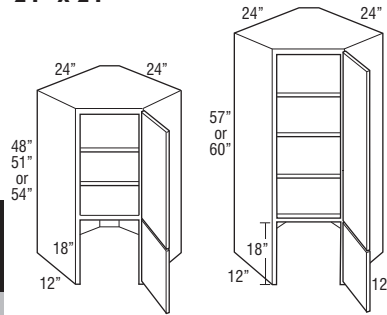

DW302424D L or R  
DW332424D L or R  
DW362424D L or R

DW392424D L or R  
DW422424D L or R

Model	1	2	3	4	5	6
DW302424D L or R	956	1016	1052	1179	1222	1278
DW332424D L or R	1019	1083	1116	1260	1306	1364
DW362424D L or R	1083	1150	1176	1340	1391	1448
DW392424D L or R	1190	1267	1296	1473	1529	1594
DW422424D L or R	1212	1289	1300	1494	1554	1625

- Cabinets require 24" x 24" of corner wall space.
- Bottom door will always be square.
- Bottom section does not have floor.
- Mullion Doors not available on bottom door.
- Full overlay styles use HINGEQRPO, see page 590.

**DIAGONAL WALL with LOWER DOOR, 48", 51", 54", 57", or 60" HIGH, 27" x 27"**

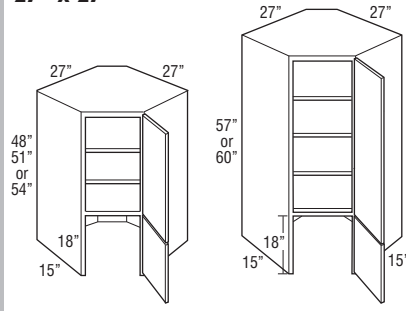

DW302727D L or R  
DW332727D L or R  
DW362727D L or R

DW392727D L or R  
DW422727D L or R

DW302727D L or R	1396	1437	1493	1614	1650	1943
DW332727D L or R	1453	1496	1554	1685	1722	2036
DW362727D L or R	1509	1553	1618	1754	1797	2128
DW392727D L or R	1660	1709	1781	1930	1977	2339
DW422727D L or R	1654	1704	1755	1931	1984	2326

- Cabinets require 27" x 27" of corner wall space.
- Bottom door will always be square.
- Bottom section does not have floor.
- Mullion Doors not available on bottom door.
- Full overlay styles use HINGEQRPO, see page 590.

**DIAGONAL WALL with LOWER DOOR and LAZY SUSAN, 48", 51", 54", 57", or 60" HIGH, 24" x 24"**

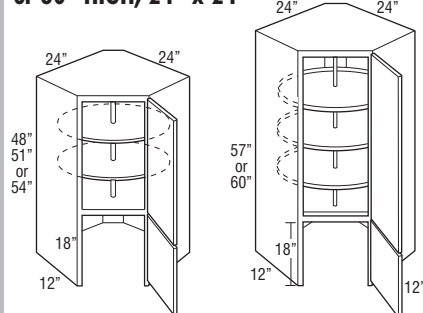

DW302424DS L or R  
DW332424DS L or R  
DW362424DS L or R

DW392424DS L or R  
DW422424DS L or R

DW302424DS L or R	1248	1327	1371	1514	1579	1650
DW332424DS L or R	1334	1422	1449	1633	1696	1768
DW362424DS L or R	1421	1517	1525	1753	1809	1886
DW392424DS L or R	1563	1669	1680	1927	1991	2074
DW422424DS L or R	1594	1666	1683	1957	2031	2122

- Cabinets require 24" x 24" of corner wall space.
- Bottom door will always be square.
- Bottom section does not have floor.
- Mullion Doors not available on bottom door.
- Plywood shelves are 18" in overall diameter with a 17" interior diameter and 1" high lip.
- Shelves rotate independently.
- Full overlay styles use HINGEQRPO, see page 590.

Model	7	8	9	10	11	12	13	14	15	16	17	18
DW302424D L or R	1298	1354	1381	1438	1449	1479	1539	1546	1607	1651	1721	1792
DW332424D L or R	1387	1446	1473	1535	1546	1577	1640	1649	1717	1762	1837	1910
DW362424D L or R	1473	1537	1565	1628	1641	1676	1744	1750	1826	1874	1952	2029
DW392424D L or R	1620	1689	1722	1793	1805	1843	1917	1925	2007	2061	2146	2232
DW422424D L or R	1644	1721	1754	1829	1842	1881	1954	1961	2045	2100	2188	2275

**Custom Modifications**

ADDTK	AUTHL AUTHR	CBO	CCO	CFNTO	CFRMO	CND	EXBKL EXBKR	EXL EXR	FB	FFDL FFDR	FPEB	ID	INVFRM	MIP	P	PFINBTMB	RD	TD	TVRAV TVRFV TVRVV	WLI
	•	•	•	•	•				•		•	•		•			•			•

**Construction Upgrades**

APC	PE
•	•

**Door Options**

ALF	CG	CG.BTM	CG.TOP	DPSRR	MD	MD.BTM	MD.TOP	MFO
		•	•	•			•	•

DW302727D L or R	1777	2057	2099	2184	2203	2246	2416	2317	2416	2483	2588	2691
DW332727D L or R	1853	2156	2201	2289	2307	2354	2536	2434	2536	2612	2721	2829
DW362727D L or R	1930	2256	2300	2392	2414	2463	2657	2553	2657	2738	2852	2967
DW392727D L or R	2125	2480	2529	2634	2654	2708	2923	2809	2923	3014	3139	3263
DW422727D L or R	2126	2465	2512	2613	2639	2690	2931	2815	2931	3044	3170	3296

**Custom Modifications**

ADDTK	AUTHL AUTHR	CBO	CCO	CFNTO	CFRMO	CND	EXBKL EXBKR	EXL EXR	FB	FFDL FFDR	FPEB	ID	INVFRM	MIP	P	PFINBTMB	RD	TD	TVRAV TVRFV TVRVV	WLI
	•	•	•	•	•				•		•	•		•			•			•

**Construction Upgrades**

APC	PE
•	•

**Door Options**

ALF	CG	CG.BTM	CG.TOP	DPSRR	MD	MD.BTM	MD.TOP	MFO
		•	•	•			•	•

DW302424DS L or R	1666	1748	1784	1855	1870	1909	1985	1997	2078	2134	2224	2313
DW332424DS L or R	1798	1874	1912	1987	2004	2045	2127	2138	2226	2288	2383	2477
DW362424DS L or R	1927	2000	2038	2122	2136	2181	2265	2279	2375	2439	2541	2642
DW392424DS L or R	2122	2200	2242	2333	2350	2395	2493	2508	2610	2683	2794	2908
DW422424DS L or R	2152	2249	2292	2384	2404	2453	2553	2567	2674	2740	2855	2971

**Custom Modifications**

ADDTK	AUTHL AUTHR	CBO	CCO	CFNTO	CFRMO	CND	EXBKL EXBKR	EXL EXR	FB	FFDL FFDR	FPEB	ID	INVFRM	MIP	P	PFINBTMB	RD	TD	TVRAV TVRFV TVRVV	WLI
	•	•	•	•	•				•		•	•		•			•			•

**Construction Upgrades**

APC	PE
•	•

**Door Options**

ALF	CG	CG.BTM	CG.TOP	DPSRR	MD	MD.BTM	MD.TOP	MFO
		•	•	•			•	•



**STACKED DIAGONAL WALL,  
48", 51", 54", 57", or 60" HIGH,  
24" x 24"**

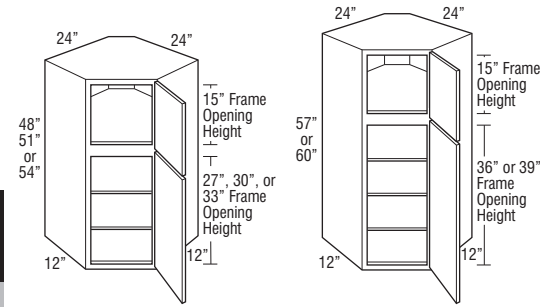

STDW482424 L or R  
STDW512424 L or R  
STDW542424 L or R

STDW572424 L or R  
STDW602424 L or R

Model	1	2	3	4	5	6
STDW482424 L or R	1731	1760	1831	1923	1952	1981
STDW512424 L or R	1797	1833	1896	2005	2039	2074
STDW542424 L or R	1861	1902	1960	2087	2126	2165
STDW572424 L or R	1923	1966	2032	2170	2211	2257
STDW602424 L or R	1994	2040	2089	2249	2298	2349

- Cabinet requires 24" x 24" of corner wall space.
- Bottom doors will always be square.
- Full overlay styles use HINGEQRPO, see page 590.

**STACKED DIAGONAL WALL,  
48", 51", 54", 57", or 60" HIGH,  
27" x 27"**

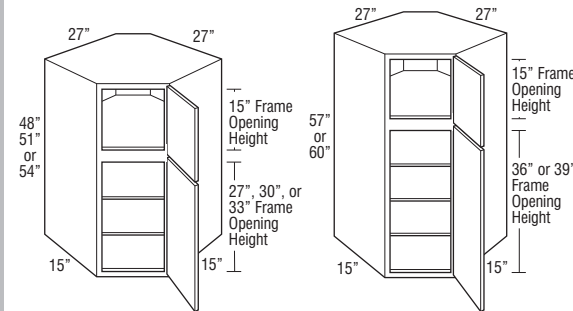

STDW482727 L or R  
STDW512727 L or R  
STDW542727 L or R

STDW572727 L or R  
STDW602727 L or R

STDW482727 L or R	2337	2378	2434	2556	2591	2876
STDW512727 L or R	2393	2436	2497	2625	2667	2967
STDW542727 L or R	2449	2494	2560	2696	2738	3057
STDW572727 L or R	2543	2593	2665	2817	2863	3213
STDW602727 L or R	2594	2645	2697	2873	2925	3258

- Cabinet requires 27" x 27" of corner wall space.
- Bottom doors will always be square.
- Full overlay styles use HINGEQRPO, see page 590.

Model	7	8	9	10	11	12	13	14	15	16	17	18
STDW482424 L or R	1990	2025	2041	2073	2081	2096	2130	2133	2170	2196	2234	2324
STDW512424 L or R	2081	2123	2141	2176	2183	2203	2241	2244	2286	2314	2357	2451
STDW542424 L or R	2170	2218	2240	2276	2287	2308	2350	2354	2401	2432	2479	2580
STDW572424 L or R	2260	2315	2336	2380	2387	2415	2461	2465	2514	2549	2600	2707
STDW602424 L or R	2347	2414	2437	2483	2493	2520	2569	2576	2633	2668	2726	2836

**Custom Modifications**

ADDTK	AUTHL AUTHR	CBO	CCO	CFNTO	CFRMO	CND	EXBKL EXBKR	EXL EXR	FB	FFDL FFDR	FPEB	ID	INVRM	MIP	P	PFINBTMB	RD	TD	TVRAV TVRFV TVRVV	WLI
	•	•	•	•	•				•		•	•	•	•		•	•			•

**Construction Upgrades**

APC	PE
•	•

**Door Options**

ALF	CG	CG.BTM	CG.TOP	DPSRR	MD	MD.BTM	MD.TOP	MFO
		•	•	•				•

STDW482727 L or R	2660	2957	2988	3047	3057	3091	3294	3221	3294	3391	3466	3604
STDW512727 L or R	2737	3055	3088	3149	3164	3197	3413	3338	3413	3517	3600	3743
STDW542727 L or R	2817	3152	3187	3254	3268	3303	3535	3454	3535	3644	3733	3881
STDW572727 L or R	2946	3315	3353	3429	3444	3482	3739	3648	3739	3857	3954	4113
STDW602727 L or R	3007	3361	3401	3477	3492	3532	3810	3717	3810	3945	4046	4210

**Custom Modifications**

ADDTK	AUTHL AUTHR	CBO	CCO	CFNTO	CFRMO	CND	EXBKL EXBKR	EXL EXR	FB	FFDL FFDR	FPEB	ID	INVRM	MIP	P	PFINBTMB	RD	TD	TVRAV TVRFV TVRVV	WLI
	•	•	•	•	•				•		•	•	•	•		•	•			•

**Construction Upgrades**

APC	PE
•	•

**Door Options**

ALF	CG	CG.BTM	CG.TOP	DPSRR	MD	MD.BTM	MD.TOP	MFO
		•	•	•				•

**DIAGONAL WALL PENINSULA,  
30", 33", 36", 39", or 42" HIGH,  
24" x 24 1/4"**

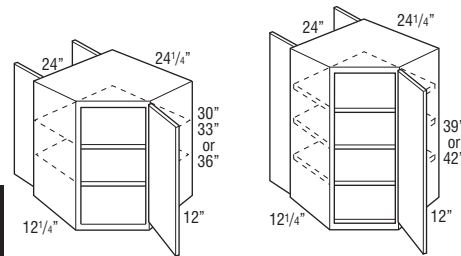

Model	1	2	3	4	5	6
DW302424PLL	847	905	1027	1197	1247	1298
DW302424PLR	847	905	1027	1197	1247	1298
DW302424PRL	847	905	1027	1197	1247	1298
DW302424PRR	847	905	1027	1197	1247	1298
DW332424PLL	967	1031	1145	1342	1403	1464
DW332424PLR	967	1031	1145	1342	1403	1464
DW332424PRL	967	1031	1145	1342	1403	1464
DW332424PRR	967	1031	1145	1342	1403	1464
DW362424PLL	1086	1160	1264	1490	1559	1632
DW362424PLR	1086	1160	1264	1490	1559	1632
DW362424PRL	1086	1160	1264	1490	1559	1632
DW362424PRR	1086	1160	1264	1490	1559	1632

DW392424PLL*	1197	1274	1391	1638	1714	1796
DW392424PLR*	1197	1274	1391	1638	1714	1796
DW392424PRL*	1197	1274	1391	1638	1714	1796
DW392424PRR*	1197	1274	1391	1638	1714	1796
DW422424PLL*	1320	1405	1494	1781	1867	1959
DW422424PLR*	1320	1405	1494	1781	1867	1959
DW422424PRL*	1320	1405	1494	1781	1867	1959
DW422424PRR*	1320	1405	1494	1781	1867	1959

- RL door hinging shown.
- Full overlay styles use HINGEORPO, see page 590.
- \*When ordered with MD, shelves will not align with mullions.

**Diagonal Wall Peninsula**

Diagonals are different. All PLL, PLR, etc. designations refer to wall openings as well as hinge location. A PLL is left hinged on the kitchen (DW) side. Peninsula side is 24" wide and features butt doors. The second L or R in the product code indicates the position of the butt doors relative to the DW side.

**NOTE:**  
All Peninsula wall cabinets must be fully supported by screwing into ceiling or soffit, and by screwing into adjoining cabinets. Weight load limit is 15 lbs. per square foot.

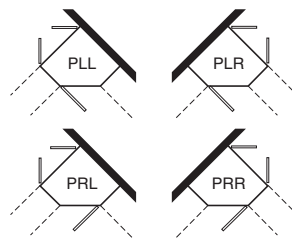

Model	7	8	9	10	11	12	13	14	15	16	17	18
DW302424PLL	1315	1377	1406	1462	1478	1506	1567	1574	1638	1684	1755	1827
DW302424PLR	1315	1377	1406	1462	1478	1506	1567	1574	1638	1684	1755	1827
DW302424PRL	1315	1377	1406	1462	1478	1506	1567	1574	1638	1684	1755	1827
DW302424PRR	1315	1377	1406	1462	1478	1506	1567	1574	1638	1684	1755	1827
DW332424PLL	1478	1552	1588	1649	1664	1698	1766	1772	1848	1898	1976	2056
DW332424PLR	1478	1552	1588	1649	1664	1698	1766	1772	1848	1898	1976	2056
DW332424PRL	1478	1552	1588	1649	1664	1698	1766	1772	1848	1898	1976	2056
DW332424PRR	1478	1552	1588	1649	1664	1698	1766	1772	1848	1898	1976	2056
DW362424PLL	1638	1728	1762	1834	1849	1889	1961	1971	2054	2111	2198	2284
DW362424PLR	1638	1728	1762	1834	1849	1889	1961	1971	2054	2111	2198	2284
DW362424PRL	1638	1728	1762	1834	1849	1889	1961	1971	2054	2111	2198	2284
DW362424PRR	1638	1728	1762	1834	1849	1889	1961	1971	2054	2111	2198	2284

DW392424PLL	1801	1900	1941	2015	2032	2078	2159	2168	2260	2320	2416	2512
DW392424PLR	1801	1900	1941	2015	2032	2078	2159	2168	2260	2320	2416	2512
DW392424PRL	1801	1900	1941	2015	2032	2078	2159	2168	2260	2320	2416	2512
DW392424PRR	1801	1900	1941	2015	2032	2078	2159	2168	2260	2320	2416	2512
DW422424PLL	1957	2076	2123	2206	2222	2268	2360	2371	2470	2535	2641	2744
DW422424PLR	1957	2076	2123	2206	2222	2268	2360	2371	2470	2535	2641	2744
DW422424PRL	1957	2076	2123	2206	2222	2268	2360	2371	2470	2535	2641	2744
DW422424PRR	1957	2076	2123	2206	2222	2268	2360	2371	2470	2535	2641	2744

**Custom Modifications**

ADDTK	AUTHL AUTHR	CBO	CCO	CFNTO	CFRMO	CND	EXBKL EXBKR	EXL EXR	FB	FFDL FFDR	FPEB	ID	INVFRM	MIP	P	PFINBTMB	RD	TD	TVRAV TVRFV TVRVV	WLI
		•	•		•				•		•			•	STD	•				•

**Construction Upgrades**

APC	PE
•	•

**Door Options**

ALF	CG	CG.BTM	CG.TOP	DPSRR	MD	MD.BTM	MD.TOP	MFO
	•			•	•			•

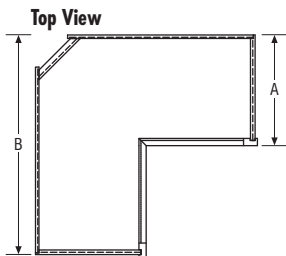

Easy Reach Wall Corner Cabinets with Increased or Reduced Depth

	RD9	RD10	RD11	STD	ID13	ID14	ID15	ID16	ID17	ID18	ID19	ID20	ID21	ID22	ID23	ID24
Cabinet Depth (ER_2424)	A 9"	10"	11"	12"	13"	14"	15"	16"	17"	18"	19"	20"	21"	22"	23"	24"
Wall Space (ER_2424)	B 21"	22"	23"	24"	25"	26"	27"	28"	29"	30"	31"	32"	33"	34"	35"	36"
Cabinet Depth (ER_2121)	A 9"	10"	11"	12"	13"	14"	15"	16"	17"	18"	19"	20"	21"	22"	23"	24"
Wall Space (ER_2121)	B 18"	19"	20"	21"	22"	23"	24"	25"	26"	27"	28"	29"	30"	31"	32"	33"

**EASY REACH WALL CORNER, 30", 33", 36", 39", or 42" HIGH, 21" x 21"**

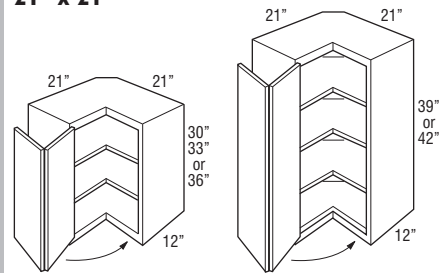

Model	1	2	3	4	5	6
ER302121 L or R	707	753	813	924	974	1015
ER332121 L or R	792	844	904	1026	1081	1128
ER362121 L or R	878	935	990	1128	1187	1242
ER392121 L or R	966	1030	1088	1242	1306	1366
ER422121 L or R	966	1030	1088	1242	1306	1366

- Decorative hardware screws must be countersunk to prevent scratching of adjacent cabinets and face frame of ER.
- Adjustable shelves.
- Hinged door opens 170°.
- Integrated soft-close hinge not included.

**EASY REACH WALL CORNER, 30", 33", 36", 39", or 42" HIGH, 24" x 24"**

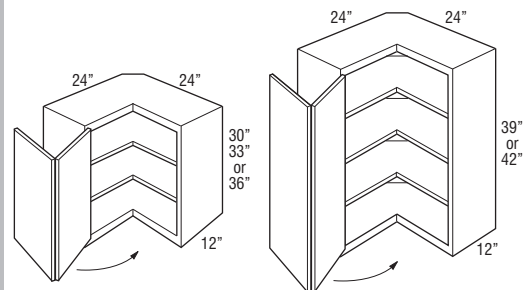

Model	1	2	3	4	5	6
ER30 L or R	707	753	813	924	974	1015
ER33 L or R	792	844	904	1026	1081	1128
ER36 L or R	878	935	990	1128	1187	1242
ER39 L or R	966	1030	1088	1242	1306	1366
ER42 L or R	1044	1116	1167	1327	1399	1464

- Requires 24" x 24" of corner wall space.
- Decorative hardware screws must be countersunk to prevent scratching of adjacent cabinets and face frame of ER.
- Adjustable shelves.
- Hinged door opens 170°.
- Integrated soft-close hinge not included.

Model	7	8	9	10	11	12	13	14	15	16	17	18
ER302121 L or R	1017	1077	1096	1139	1150	1175	1222	1225	1277	1314	1370	1424
ER332121 L or R	1130	1197	1219	1268	1278	1306	1356	1363	1421	1457	1519	1579
ER362121 L or R	1242	1315	1341	1394	1405	1436	1492	1499	1562	1602	1668	1736
ER392121 L or R	1366	1447	1475	1535	1548	1578	1641	1649	1718	1762	1836	1909
ER422121 L or R	1366	1447	1475	1535	1548	1578	1641	1649	1718	1762	1836	1909

Custom Modifications

ADDTK	AUTHL AUTHR	CBO	CCO	CFNTO	CFRMO	CND	EXBKL EXBKR	EXL EXR	FB	FFDL FFDR	FPEB	ID	INVRM	MIP	P	PFINBTMB	RD	TD	TVRAV TVRFV TVRVV	WLI
	•	•	•						•		•	•		•		•	•			•

Construction Upgrades

APC	PE
•	•

Door Options

ALF	CG	CG.BTM	CG.TOP	DPSRR	MD	MD.BTM	MD.TOP	MFO
				•				•

Model	7	8	9	10	11	12	13	14	15	16	17	18
ER30 L or R	1017	1077	1096	1139	1150	1175	1222	1225	1277	1314	1370	1424
ER33 L or R	1130	1197	1219	1268	1278	1306	1356	1363	1421	1457	1519	1579
ER36 L or R	1242	1315	1341	1394	1405	1436	1492	1499	1562	1602	1668	1736
ER39 L or R	1366	1447	1475	1535	1548	1578	1641	1649	1718	1762	1836	1909
ER42 L or R	1458	1552	1583	1646	1661	1696	1765	1771	1844	1896	1975	2055

Custom Modifications

ADDTK	AUTHL AUTHR	CBO	CCO	CFNTO	CFRMO	CND	EXBKL EXBKR	EXL EXR	FB	FFDL FFDR	FPEB	ID	INVRM	MIP	P	PFINBTMB	RD	TD	TVRAV TVRFV TVRVV	WLI
	•	•	•						•		•	•		•		•	•			•

Construction Upgrades

APC	PE
•	•

Door Options

ALF	CG	CG.BTM	CG.TOP	DPSRR	MD	MD.BTM	MD.TOP	MFO
				•				•

**ASYMMETRICAL EASY REACH WALL CORNER, 30", 33", 36", 39", or 42" HIGH**

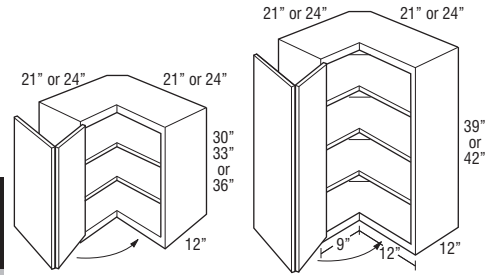

Model	1	2	3	4	5	6
ER302124 L or R	707	753	813	924	974	1015
ER302421 L or R	707	753	813	924	974	1015
ER332124 L or R	792	844	904	1026	1081	1128
ER332421 L or R	792	844	904	1026	1081	1128
ER362124 L or R	878	935	990	1128	1187	1242
ER362421 L or R	878	935	990	1128	1187	1242
ER392124 L or R	966	1030	1088	1242	1306	1366
ER392421 L or R	966	1030	1088	1242	1306	1366
ER422124 L or R	1044	1116	1167	1327	1399	1464
ER422421 L or R	1044	1116	1167	1327	1399	1464

- Hinged door opens to 170°.
- Adjustable shelves.
- Legs at the front frames are 9" on 21" leg and 12" on 24" leg.
- Nomenclature for asymmetrical cabinets reads as follows:  
 First set of numbers = height  
 Second set of numbers = left side  
 Third set of numbers = right side
- Decorative hardware screws must be countersunk to prevent scratching of adjacent cabinets and face frame of ER.
- ER\_2124L shown.
- Integrated soft-close hinge not included.

**135° CORNER OUTSIDE WALL, 30", 33", or 36" HIGH**

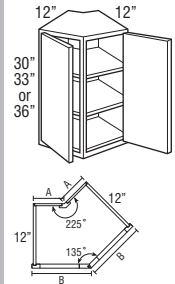

Model	A Dimension	B Dimension
W6(*)COA	6"	10 15/16"
W9(*)COA	9"	13 15/16"
W12(*)COA	12"	16 15/16"

A indicates back width of cabinet and wall space.  
 (\*) indicates height of cabinet.  
 B indicates face frame width.

W630COA	1060	1131	1220	1388	1461	1521
W930COA	1114	1187	1281	1456	1535	1599
W1230COA	1167	1245	1343	1524	1606	1675
W633COA	1189	1267	1353	1541	1621	1692
W933COA	1249	1330	1422	1618	1702	1777
W1233COA	1309	1394	1490	1693	1783	1860
W636COA	1317	1404	1487	1692	1781	1861
W936COA	1384	1475	1559	1777	1869	1956
W1236COA	1450	1545	1633	1860	1958	2048

- Doors are hinged on outside of frame.
- Adjustable shelves cannot be removed from cabinet.

Model	7	8	9	10	11	12	13	14	15	16	17	18
ER302124 L or R	1017	1077	1096	1139	1150	1175	1222	1225	1277	1314	1370	1424
ER302421 L or R	1017	1077	1096	1139	1150	1175	1222	1225	1277	1314	1370	1424
ER332124 L or R	1130	1197	1219	1268	1278	1306	1356	1363	1421	1457	1519	1579
ER332421 L or R	1130	1197	1219	1268	1278	1306	1356	1363	1421	1457	1519	1579
ER362124 L or R	1242	1315	1341	1394	1405	1436	1492	1499	1562	1602	1668	1736
ER362421 L or R	1242	1315	1341	1394	1405	1436	1492	1499	1562	1602	1668	1736
ER392124 L or R	1366	1447	1475	1535	1548	1578	1641	1649	1718	1762	1836	1909
ER392421 L or R	1366	1447	1475	1535	1548	1578	1641	1649	1718	1762	1836	1909
ER422124 L or R	1458	1552	1583	1646	1661	1696	1765	1771	1844	1896	1975	2055
ER422421 L or R	1458	1552	1583	1646	1661	1696	1765	1771	1844	1896	1975	2055

**Custom Modifications**

ADDTK	AUTHL AUTHR	CBO	CCO	CFNTO	CFRMO	CND	EXBKL EXBKR	EXL EXR	FB	FFDL	FPEB	ID	INVFRM	MIP	P	PFINBTMB	RD	TD	TVRAV TVRFV TVRVV	WLI
	•	•	•						•		•	•		•		•	•			•

**Construction Upgrades**

APC	PE
•	•

**Door Options**

ALF	CG	CG.BTM	CG.TOP	DPSRR	MD	MD.BTM	MD.TOP	MFO
				•				•

W630COA	1524	1617	1644	1710	1724	1766	1835	1839	1915	1972	2055	2136
W930COA	1602	1697	1725	1796	1810	1853	1926	1931	2011	2070	2157	2243
W1230COA	1679	1778	1807	1882	1897	1943	2019	2024	2106	2168	2260	2351
W633COA	1693	1795	1830	1901	1918	1959	2036	2042	2131	2186	2279	2371
W933COA	1778	1885	1921	1998	2013	2058	2138	2144	2237	2296	2393	2488
W1233COA	1861	1974	2011	2091	2109	2154	2240	2248	2344	2405	2508	2608
W636COA	1861	1974	2011	2091	2108	2153	2237	2248	2343	2404	2502	2606
W936COA	1956	2073	2112	2196	2214	2262	2350	2360	2461	2524	2626	2735
W1236COA	2048	2173	2213	2301	2319	2369	2462	2472	2579	2644	2753	2866

**Custom Modifications**

ADDTK	AUTHL AUTHR	CBO	CCO	CFNTO	CFRMO	CND	EXBKL EXBKR	EXL EXR	FB	FFDL	FPEB	ID	INVFRM	MIP	P	PFINBTMB	RD	TD	TVRAV TVRFV TVRVV	WLI
		•	•						•		•	•		•		•	•			•

**Construction Upgrades**

APC	PE
•	•

**Door Options**

ALF	CG	CG.BTM	CG.TOP	DPSRR	MD	MD.BTM	MD.TOP	MFO
				•				•

**135° CORNER OUTSIDE WALL, 39" or 42" HIGH**

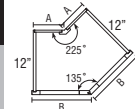
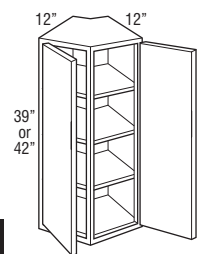

Model	A Dimension	B Dimension
W6(*)COA	6"	10 15/16"
W9(*)COA	9"	13 15/16"
W12(*)COA	12"	16 15/16"

A indicates back width of cabinet and wall space.  
 (\*) indicates height of cabinet.  
 B indicates face frame width.

Model	1	2	3	4	5	6
W639COA	1450	1545	1633	1861	1959	2047
W939COA	1521	1622	1716	1956	2058	2150
W1239COA	1595	1699	1797	2048	2154	2252
W642COA	1567	1675	1751	1990	2099	2198
W942COA	1646	1757	1839	2090	2205	2306
W1242COA	1724	1843	1926	2189	2310	2417

- Doors are hinged on outside of frame.
- Adjustable shelves cannot be removed from cabinet.

**135° CORNER INSIDE WALL, 30", 33", or 36" HIGH**

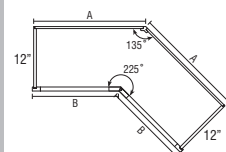
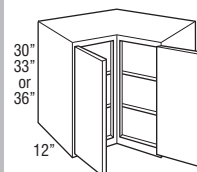

Model	A Dimension	B Dimension
W21(*)CIA	21"	16 1/16"
W24(*)CIA	24"	19 1/16"
W27(*)CIA	27"	22 1/16"

A indicates back width of cabinet and wall space.  
 (\*) indicates height of cabinet.  
 B indicates face frame width.

W2130CIA	1060	1131	1220	1388	1461	1521
W2430CIA	1114	1187	1281	1456	1535	1599
W2730CIA	1167	1245	1343	1524	1606	1675
W2133CIA	1189	1267	1353	1541	1621	1692
W2433CIA	1249	1330	1422	1618	1702	1777
W2733CIA	1309	1394	1490	1693	1783	1860
W2136CIA	1317	1404	1487	1692	1781	1861
W2436CIA	1384	1475	1559	1777	1869	1956
W2736CIA	1450	1545	1633	1860	1958	2048

- Doors are hinged on outside of frame.
- Adjustable shelves cannot be removed from cabinet.

Model	7	8	9	10	11	12	13	14	15	16	17	18
W639COA	2047	2170	2213	2301	2321	2369	2464	2473	2579	2644	2756	2863
W939COA	2150	2277	2325	2416	2437	2487	2586	2596	2707	2775	2891	3006
W1239COA	2252	2386	2434	2531	2555	2607	2710	2721	2836	2910	3028	3149
W642COA	2188	2329	2377	2470	2492	2543	2646	2657	2766	2845	2963	3081
W942COA	2299	2444	2495	2593	2617	2671	2778	2790	2904	2987	3111	3235
W1242COA	2409	2561	2613	2717	2739	2798	2912	2924	3044	3129	3258	3391

**Custom Modifications**

ADDTK	AUTHL AUTHR	CBO	CCO	CFNTO	CFRMO	CND	EXBKL EXBKR	EXL EXR	FB	FFDL FFDR	FPEB	ID	INVRM	MIP	P	PFINBTMB	RD	TD	TVRAV TVRFV TVRVV	WLI
		•	•						•		•			•		•				•

**Construction Upgrades**

APC	PE
•	•

**Door Options**

ALF	CG	CG.BTM	CG.TOP	DPSRR	MD	MD.BTM	MD.TOP	MFO
	•			•				•

W2130CIA	1524	1617	1644	1710	1724	1766	1835	1839	1915	1972	2055	2136
W2430CIA	1602	1697	1725	1796	1810	1853	1926	1931	2011	2070	2157	2243
W2730CIA	1679	1778	1807	1882	1897	1943	2019	2024	2106	2168	2260	2351
W2133CIA	1693	1795	1830	1901	1918	1959	2036	2042	2131	2186	2279	2371
W2433CIA	1778	1885	1921	1998	2013	2058	2138	2144	2237	2296	2393	2488
W2733CIA	1861	1974	2011	2091	2109	2154	2240	2248	2344	2405	2508	2608
W2136CIA	1861	1974	2011	2091	2108	2153	2237	2248	2343	2404	2502	2606
W2436CIA	1956	2073	2112	2196	2214	2262	2350	2360	2461	2524	2626	2735
W2736CIA	2048	2173	2213	2301	2319	2369	2462	2472	2579	2644	2753	2866

**Custom Modifications**

ADDTK	AUTHL AUTHR	CBO	CCO	CFNTO	CFRMO	CND	EXBKL EXBKR	EXL EXR	FB	FFDL FFDR	FPEB	ID	INVRM	MIP	P	PFINBTMB	RD	TD	TVRAV TVRFV TVRVV	WLI
		•	•						•		•			•		•				•

**Construction Upgrades**

APC	PE
•	•

**Door Options**

ALF	CG	CG.BTM	CG.TOP	DPSRR	MD	MD.BTM	MD.TOP	MFO
	•			•	• <sup>†</sup>			•

<sup>†</sup>Available only on W2430CIA, W2433CIA, and W2436CIA

**135° CORNER INSIDE WALL, 39" or 42" HIGH**

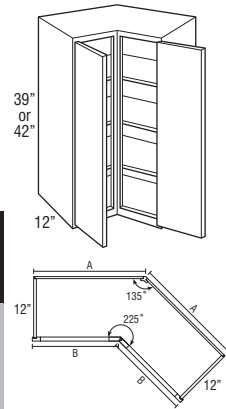

Model	A Dimension	B Dimension
W21(*)CIA	21"	16 1/16"
W24(*)CIA	24"	19 1/16"
W27(*)CIA	27"	22 1/16"

A indicates back width of cabinet and wall space.  
 (\*) indicates height of cabinet.  
 B indicates face frame width.

Model	1	2	3	4	5	6
W2139CIA	1450	1545	1633	1861	1959	2047
W2439CIA	1521	1622	1716	1956	2058	2150
W2739CIA	1595	1699	1797	2048	2154	2252
W2142CIA	1567	1675	1751	1990	2099	2198
W2442CIA	1646	1757	1839	2090	2205	2306
W2742CIA	1724	1843	1926	2189	2310	2417

- Doors are hinged on outside of frame.
- Adjustable shelves cannot be removed from cabinet.

**WALL END CABINET SINGLE DOOR, 30", 33", 36", 39", or 42" HIGH, 12" x 12"**

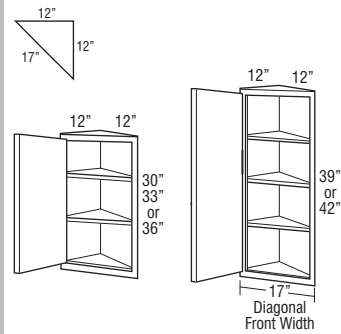

WEC1230 L or R	362	387	452	526	544	573
WEC1233 L or R	398	425	506	589	614	641
WEC1236 L or R	429	461	561	655	681	712
WEC1239 L or R*	472	507	617	720	750	785
WEC1242 L or R*	498	528	666	787	813	854

- Width at wall: 12" x 12".
- Cabinet features two unfinished back panels. Must be installed with one back panel adjacent to a cabinet of equal height with the other back panel attached to the wall.

\*When ordered with MD, shelves will not align with mullions.

**WALL END CABINET DOUBLE DOOR, 30", 33", 36", 39", or 42" HIGH, 12" x 12"**

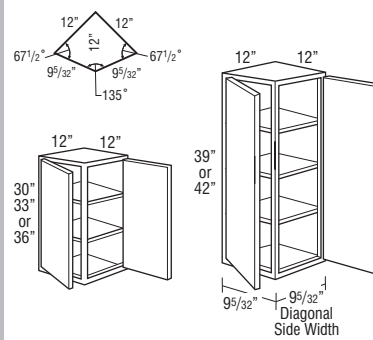

WEC1230D	663	688	708	743	777	819
WEC1233D	699	734	763	806	843	888
WEC1236D	733	779	818	867	912	959
WEC1239D	807	857	898	954	1001	1052
WEC1242D	797	852	925	990	1043	1100

- Width at wall: 12" x 12".
- Cabinet features two unfinished back panels. Must be installed with one back panel adjacent to a cabinet of equal height with the other back panel attached to the wall.
- Decorative glass inserts are not available.

Model	7	8	9	10	11	12	13	14	15	16	17	18
W2139CIA	2047	2170	2213	2301	2321	2369	2464	2473	2579	2644	2756	2863
W2439CIA	2150	2277	2325	2416	2437	2487	2586	2596	2707	2775	2891	3006
W2739CIA	2252	2386	2434	2531	2555	2607	2710	2721	2836	2910	3028	3149
W2142CIA	2188	2329	2377	2470	2492	2543	2646	2657	2766	2845	2963	3081
W2442CIA	2299	2444	2495	2593	2617	2671	2778	2790	2904	2987	3111	3235
W2742CIA	2409	2561	2613	2717	2739	2798	2912	2924	3044	3129	3258	3391

**Custom Modifications**

ADDTK	AUTHL AUTHR	CBO	CCO	CFNTO	CFRMO	CND	EXBKL EXBKR	EXL EXR	FB	FFDL FFDR	FPEB	ID	INVERM	MIP	P	PFINBTMB	RD	TD	TVRAV TVRFV TVRVV	WLI
			•	•					•		•			•		•				•

**Construction Upgrades**

APC	PE
•	•

**Door Options**

ALF	CG	CG.BTM	CG.TOP	DPSRR	MD	MD.BTM	MD.TOP	MFO
	•			•	•†			•

†Available only on W2439CIA and W2442CIA

WEC1230 L or R	578	610	619	645	651	662	691	693	721	742	771	803
WEC1233 L or R	650	682	696	725	730	744	777	779	811	833	868	904
WEC1236 L or R	720	757	771	804	810	827	863	864	898	924	963	1000
WEC1239 L or R	791	832	847	882	889	911	947	949	989	1017	1058	1100
WEC1242 L or R	867	907	923	960	967	988	1026	1031	1075	1101	1146	1194

**Custom Modifications**

ADDTK	AUTHL AUTHR	CBO	CCO	CFNTO	CFRMO	CND	EXBKL EXBKR	EXL EXR	FB	FFDL FFDR	FPEB	ID	INVERM	MIP	P	PFINBTMB	RD	TD	TVRAV TVRFV TVRVV	WLI
			•	•										•		•				•

**Construction Upgrades**

APC	PE
•	

**Door Options**

ALF	CG	CG.BTM	CG.TOP	DPSRR	MD	MD.BTM	MD.TOP	MFO
	•			•	•			•

WEC1230D	818	868	882	918	929	947	985	987	1029	1058	1101	1145
WEC1233D	884	939	961	996	1009	1027	1069	1074	1118	1149	1197	1245
WEC1236D	954	1015	1036	1078	1086	1107	1153	1161	1209	1239	1290	1341
WEC1239D	1047	1116	1138	1186	1195	1218	1268	1274	1329	1363	1420	1476
WEC1242D	1088	1167	1189	1239	1249	1274	1327	1334	1389	1426	1484	1545

**Custom Modifications**

ADDTK	AUTHL AUTHR	CBO	CCO	CFNTO	CFRMO	CND	EXBKL EXBKR	EXL EXR	FB	FFDL FFDR	FPEB	ID	INVERM	MIP	P	PFINBTMB	RD	TD	TVRAV TVRFV TVRVV	WLI
			•	•										•		•				•

**Construction Upgrades**

APC	PE
•	

**Door Options**

ALF	CG	CG.BTM	CG.TOP	DPSRR	MD	MD.BTM	MD.TOP	MFO
	•			•				•

**WALL QUARTER ROUND END SHELF, 30", 33", 36", 39", or 42" HIGH**

**Radius Top and Bottom Panels**

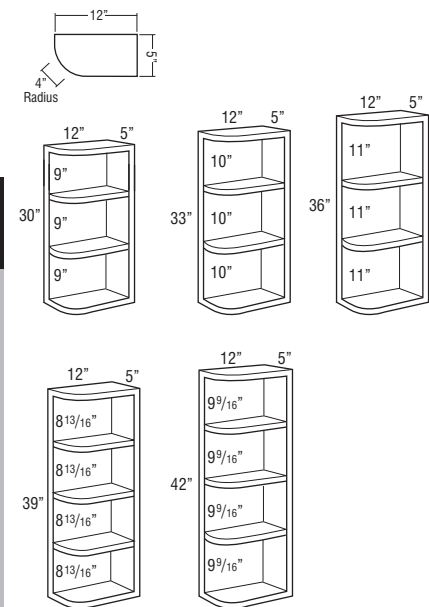

**Square Top and Radius Bottom Panels**

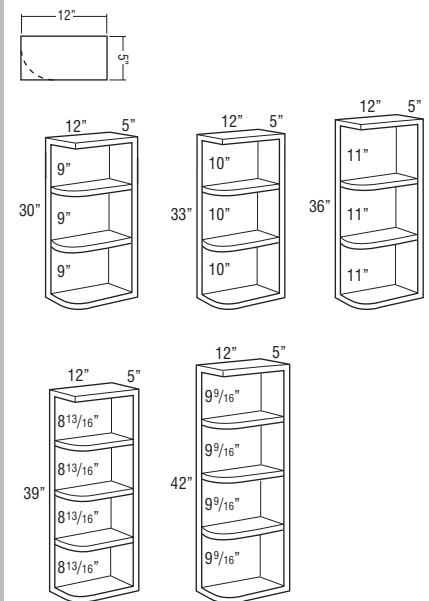

**Square Top and Bottom Panels**

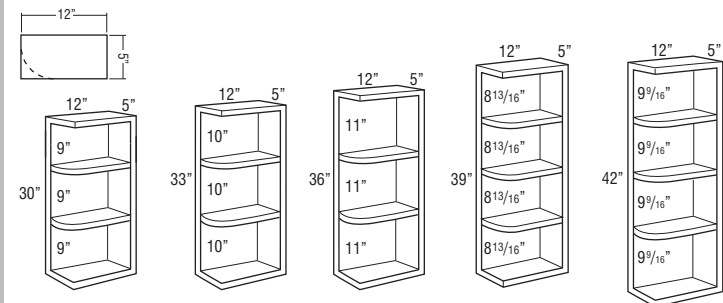

Model	1	2	3	4	5	6
WQRES630RT	459	459	459	459	459	459
WQRES633RT	484	484	484	484	484	484
WQRES636RT	509	509	509	509	509	509
WQRES639RT	560	560	560	560	560	560
WQRES642RT	560	560	560	560	560	560

- Units are reversible.
- 12" deep x 5" wide, 4" shelf radius.
- Radius moulding is not available for WQRES636RT.
- Veneer on 3/4" furniture board core with matching interior.
- If ordered with Heirloom Technique, will not feature sand-through characteristics.
- Cabinet features two unfinished back panels. Must be installed with one back panel adjacent to a cabinet of equal height with the other back panel attached to the wall.

WQRES630ST L or R	459	459	459	459	459	459
WQRES633ST L or R	484	484	484	484	484	484
WQRES636ST L or R	509	509	509	509	509	509
WQRES639ST L or R	560	560	560	560	560	560
WQRES642ST L or R	560	560	560	560	560	560

- Specify left or right. Only top panel is square. Right shown.
- Veneer on 3/4" furniture board core with matching interior.
- If ordered with Heirloom Technique, will not feature sand-through characteristics.
- Cabinet features two unfinished back panels. Must be installed with one back panel adjacent to a cabinet of equal height with the other back panel attached to the wall.

WQRES630STSB	459	459	459	459	459	459
WQRES633STSB	484	484	484	484	484	484
WQRES636STSB	509	509	509	509	509	509
WQRES639STSB	560	560	560	560	560	560
WQRES642STSB	560	560	560	560	560	560

- Units are reversible.
- Veneer on 3/4" furniture board core with matching interior.
- If ordered with Heirloom Technique, will not feature sand-through characteristics.
- Cabinet features two unfinished back panels. Must be installed with one back panel adjacent to a cabinet of equal height with the other back panel attached to the wall.

Model	7	8	9	10	11	12	13	14	15	16	17	18
WQRES630RT	459	459	459	459	459	459	459	459	459	459	459	459
WQRES633RT	484	484	484	484	484	484	484	484	484	484	484	484
WQRES636RT	509	509	509	509	509	509	509	509	509	509	509	509
WQRES639RT	560	560	560	560	560	560	560	560	560	560	560	560
WQRES642RT	560	560	560	560	560	560	560	560	560	560	560	560

WQRES630ST L or R	459	459	459	459	459	459	459	459	459	459	459	459
WQRES633ST L or R	484	484	484	484	484	484	484	484	484	484	484	484
WQRES636ST L or R	509	509	509	509	509	509	509	509	509	509	509	509
WQRES639ST L or R	560	560	560	560	560	560	560	560	560	560	560	560
WQRES642ST L or R	560	560	560	560	560	560	560	560	560	560	560	560

WQRES630STSB	459	459	459	459	459	459	459	459	459	459	459	459
WQRES633STSB	484	484	484	484	484	484	484	484	484	484	484	484
WQRES636STSB	509	509	509	509	509	509	509	509	509	509	509	509
WQRES639STSB	560	560	560	560	560	560	560	560	560	560	560	560
WQRES642STSB	560	560	560	560	560	560	560	560	560	560	560	560

**MODIFICATIONS**

No modifications available for these products.

**Construction Upgrades**

APC	PE
•	

**WALL QUARTER ROUND END SHELF,  
12" RADIUS, 30", 33", 36", 39", or  
42" HIGH**

**Radius Top and Bottom Panels**

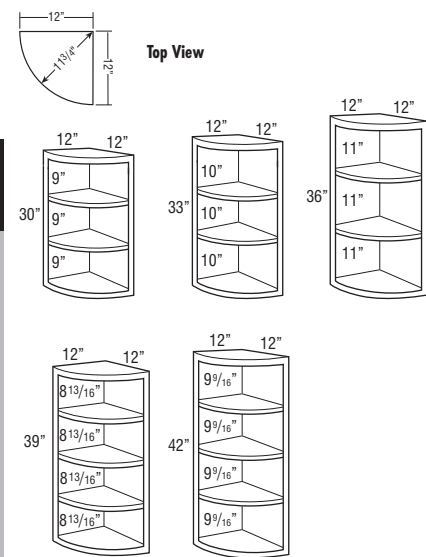

**Square Top and Radius Bottom Panels**

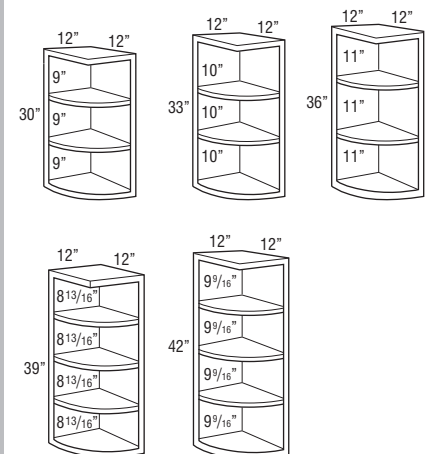

**Square Top and Bottom Panels**

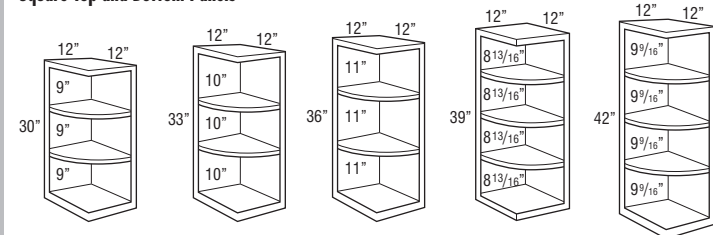

Model	1	2	3	4	5	6
WQRES1230RT	709	709	709	709	709	709
WQRES1233RT	783	783	783	783	783	783
WQRES1236RT	855	855	855	855	855	855
WQRES1239RT	938	938	938	938	938	938
WQRES1242RT	999	999	999	999	999	999

- Veneer on 3/4" furniture board core with matching interior.
- If ordered with Heirlooming Technique, will not feature sand-through characteristics.
- Cabinet features two unfinished back panels. Must be installed with one back panel adjacent to a cabinet of equal height with the other back panel attached to the wall.

WQRES1230STRB	709	709	709	709	709	709
WQRES1233STRB	783	783	783	783	783	783
WQRES1236STRB	855	855	855	855	855	855
WQRES1239STRB	938	938	938	938	938	938
WQRES1242STRB	999	999	999	999	999	999

- Veneer on 3/4" furniture board core with matching interior.
- If ordered with Heirlooming Technique, will not feature sand-through characteristics.
- Cabinet features two unfinished back panels. Must be installed with one back panel adjacent to a cabinet of equal height with the other back panel attached to the wall.

WQRES1230STSB	709	709	709	709	709	709
WQRES1233STSB	783	783	783	783	783	783
WQRES1236STSB	855	855	855	855	855	855
WQRES1239STSB	938	938	938	938	938	938
WQRES1242STSB	999	999	999	999	999	999

- Veneer on 3/4" furniture board core with matching interior.
- If ordered with Heirlooming Technique, will not feature sand-through characteristics.
- Cabinet features two unfinished back panels. Must be installed with one back panel adjacent to a cabinet of equal height with the other back panel attached to the wall.

Model	7	8	9	10	11	12	13	14	15	16	17	18
WQRES1230RT	709	709	709	709	709	709	709	709	709	709	709	709
WQRES1233RT	783	783	783	783	783	783	783	783	783	783	783	783
WQRES1236RT	855	855	855	855	855	855	855	855	855	855	855	855
WQRES1239RT	938	938	938	938	938	938	938	938	938	938	938	938
WQRES1242RT	999	999	999	999	999	999	999	999	999	999	999	999

WQRES1230STRB	709	709	709	709	709	709	709	709	709	709	709	709
WQRES1233STRB	783	783	783	783	783	783	783	783	783	783	783	783
WQRES1236STRB	855	855	855	855	855	855	855	855	855	855	855	855
WQRES1239STRB	938	938	938	938	938	938	938	938	938	938	938	938
WQRES1242STRB	999	999	999	999	999	999	999	999	999	999	999	999

WQRES1230STSB	709	709	709	709	709	709	709	709	709	709	709	709
WQRES1233STSB	783	783	783	783	783	783	783	783	783	783	783	783
WQRES1236STSB	855	855	855	855	855	855	855	855	855	855	855	855
WQRES1239STSB	938	938	938	938	938	938	938	938	938	938	938	938
WQRES1242STSB	999	999	999	999	999	999	999	999	999	999	999	999

**MODIFICATIONS**

No modifications available for these products.

**Construction Upgrades**

APC	PE
•	



**WALL TRANSITION CABINET, 30", 33", 36", 39", or 42" HIGH**

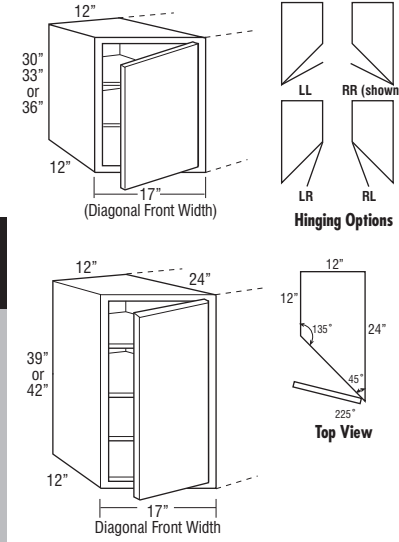

Model	1	2	3	4	5	6
WTC1230LL	516	539	552	609	678	710
WTC1230RL	516	539	552	609	678	710
WTC1230LR	516	539	552	609	678	710
WTC1230RR	516	539	552	609	678	710
WTC1233LL	583	612	625	682	762	797
WTC1233RL	583	612	625	682	762	797
WTC1233LR	583	612	625	682	762	797
WTC1233RR	583	612	625	682	762	797
WTC1236LL	650	681	697	759	844	883
WTC1236RL	650	681	697	759	844	883
WTC1236LR	650	681	697	759	844	883
WTC1236RR	650	681	697	759	844	883
WTC1239LL	714	750	766	834	930	972
WTC1239RL	714	750	766	834	930	972
WTC1239LR	714	750	766	834	930	972
WTC1239RR	714	750	766	834	930	972
WTC1242LL	782	818	841	919	1014	1063
WTC1242RL	782	818	841	919	1014	1063
WTC1242LR	782	818	841	919	1014	1063
WTC1242RR	782	818	841	919	1014	1063

- Specify door hinging. RR shown.
- Depth can be reduced to a minimum of 18".
- Full overlay styles use the same width doors as partial overlay styles (14 1/2" wide) with a partial overlay hinge (38NPOHINGE) to allow for proper door clearance with adjacent cabinets.

Model	7	8	9	10	11	12	13	14	15	16	17	18
WTC1230LL	668	755	768	801	808	824	861	862	896	921	961	998
WTC1230RL	668	755	768	801	808	824	861	862	896	921	961	998
WTC1230LR	668	755	768	801	808	824	861	862	896	921	961	998
WTC1230RR	668	755	768	801	808	824	861	862	896	921	961	998
WTC1233LL	752	845	864	896	907	924	962	965	1007	1032	1076	1119
WTC1233RL	752	845	864	896	907	924	962	965	1007	1032	1076	1119
WTC1233LR	752	845	864	896	907	924	962	965	1007	1032	1076	1119
WTC1233RR	752	845	864	896	907	924	962	965	1007	1032	1076	1119
WTC1236LL	834	937	958	993	1005	1023	1063	1069	1114	1142	1190	1239
WTC1236RL	834	937	958	993	1005	1023	1063	1069	1114	1142	1190	1239
WTC1236LR	834	937	958	993	1005	1023	1063	1069	1114	1142	1190	1239
WTC1236RR	834	937	958	993	1005	1023	1063	1069	1114	1142	1190	1239
WTC1239LL	919	1032	1051	1093	1103	1125	1169	1174	1224	1258	1310	1363
WTC1239RL	919	1032	1051	1093	1103	1125	1169	1174	1224	1258	1310	1363
WTC1239LR	919	1032	1051	1093	1103	1125	1169	1174	1224	1258	1310	1363
WTC1239RR	919	1032	1051	1093	1103	1125	1169	1174	1224	1258	1310	1363
WTC1242LL	1011	1130	1147	1197	1209	1228	1279	1286	1340	1377	1435	1492
WTC1242RL	1011	1130	1147	1197	1209	1228	1279	1286	1340	1377	1435	1492
WTC1242LR	1011	1130	1147	1197	1209	1228	1279	1286	1340	1377	1435	1492
WTC1242RR	1011	1130	1147	1197	1209	1228	1279	1286	1340	1377	1435	1492

**Custom Modifications**

ADDTK	AUTHL AUTHR	CBO	CCO	CFNTO	CFRMO	CND	EXBKL EXBKR	EXL EXR	FB	FFDL FFDR	FPEB	ID	INVRM	MIP	P	PFINBTMB	RD	TD	TVRAV TVRFV TVRVV	WLI
	•*	•	•	•	•				•	•*	•*			•		•	•			•

\*Available only on 12" deep side of cabinet

**Construction Upgrades**

APC	PE
•	•

**Door Options**

ALF	CG	CG.BTM	CG.TOP	DPSRR	MD	MD.BTM	MD.TOP	MFO
	•			•	•			•

**STACKED WALL TRANSITION CABINET,  
48", 51", 54", 57", or 60" HIGH**

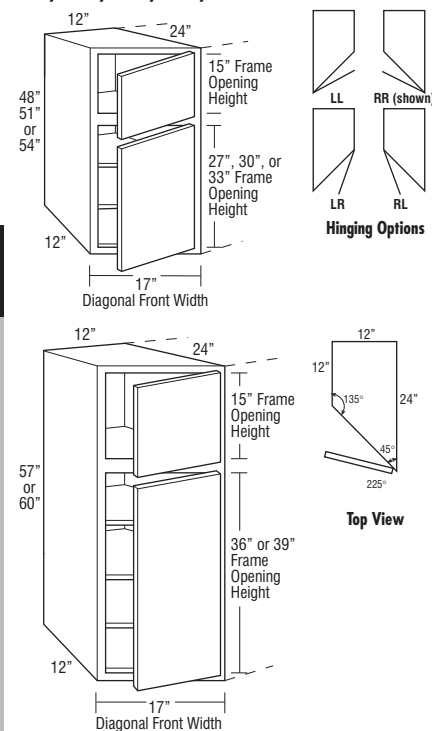

Model	1	2	3	4	5	6
STWTC1248LL	1328	1391	1429	1562	1723	1806
STWTC1248RL	1328	1391	1429	1562	1723	1806
STWTC1248LR	1328	1391	1429	1562	1723	1806
STWTC1248RR	1328	1391	1429	1562	1723	1806
STWTC1251LL	1461	1530	1573	1718	1896	1986
STWTC1251RL	1461	1530	1573	1718	1896	1986
STWTC1251LR	1461	1530	1573	1718	1896	1986
STWTC1251RR	1461	1530	1573	1718	1896	1986
STWTC1254LL	1606	1683	1731	1890	2086	2185
STWTC1254RL	1606	1683	1731	1890	2086	2185
STWTC1254LR	1606	1683	1731	1890	2086	2185
STWTC1254RR	1606	1683	1731	1890	2086	2185
STWTC1257LL	1768	1851	1903	2081	2294	2404
STWTC1257RL	1768	1851	1903	2081	2294	2404
STWTC1257LR	1768	1851	1903	2081	2294	2404
STWTC1257RR	1768	1851	1903	2081	2294	2404
STWTC1260LL	1945	2036	2095	2288	2523	2644
STWTC1260RL	1945	2036	2095	2288	2523	2644
STWTC1260LR	1945	2036	2095	2288	2523	2644
STWTC1260RR	1945	2036	2095	2288	2523	2644

- Specify door hinging. RR shown.
- Depth can be reduced to a minimum of 18".
- Full overlay styles use the same width doors as partial overlay styles (14 1/2" wide) with a partial overlay hinge (38NPOHINGE) to allow for proper door clearance with adjacent cabinets.

Model	7	8	9	10	11	12	13	14	15	16	17	18
STWTC1248LL	1718	1921	1951	2035	2054	2090	2176	2186	2277	2343	2439	2536
STWTC1248RL	1718	1921	1951	2035	2054	2090	2176	2186	2277	2343	2439	2536
STWTC1248LR	1718	1921	1951	2035	2054	2090	2176	2186	2277	2343	2439	2536
STWTC1248RR	1718	1921	1951	2035	2054	2090	2176	2186	2277	2343	2439	2536
STWTC1251LL	1890	2111	2146	2237	2259	2299	2392	2405	2506	2579	2683	2790
STWTC1251RL	1890	2111	2146	2237	2259	2299	2392	2405	2506	2579	2683	2790
STWTC1251LR	1890	2111	2146	2237	2259	2299	2392	2405	2506	2579	2683	2790
STWTC1251RR	1890	2111	2146	2237	2259	2299	2392	2405	2506	2579	2683	2790
STWTC1254LL	2081	2324	2360	2462	2484	2529	2633	2645	2757	2836	2953	3069
STWTC1254RL	2081	2324	2360	2462	2484	2529	2633	2645	2757	2836	2953	3069
STWTC1254LR	2081	2324	2360	2462	2484	2529	2633	2645	2757	2836	2953	3069
STWTC1254RR	2081	2324	2360	2462	2484	2529	2633	2645	2757	2836	2953	3069
STWTC1257LL	2288	2556	2595	2708	2733	2782	2896	2911	3030	3119	3248	3376
STWTC1257RL	2288	2556	2595	2708	2733	2782	2896	2911	3030	3119	3248	3376
STWTC1257LR	2288	2556	2595	2708	2733	2782	2896	2911	3030	3119	3248	3376
STWTC1257RR	2288	2556	2595	2708	2733	2782	2896	2911	3030	3119	3248	3376
STWTC1260LL	2517	2811	2855	2977	3006	3060	3184	3201	3335	3431	3571	3714
STWTC1260RL	2517	2811	2855	2977	3006	3060	3184	3201	3335	3431	3571	3714
STWTC1260LR	2517	2811	2855	2977	3006	3060	3184	3201	3335	3431	3571	3714
STWTC1260RR	2517	2811	2855	2977	3006	3060	3184	3201	3335	3431	3571	3714

**Custom Modifications**

ADDTK	AUTHL AUTHR	CBO	CCO	CFNTO	CFRMO	CND	EXBKL EXBKR	EXL EXR	FB STD	FFDL FFDR	FPEB	ID	INVERM	MIP	P	PFINBTMB	RD	TD	TVRAV TVRFV TVRVV	WLI
	•*	•	•	•	•					•*	•*		•	•		•	•			•

\*Available only on 12" deep side of cabinet

**Construction Upgrades**

APC	PE
•	•

**Door Options**

ALF	CG	CG.BTM	CG.TOP	DPSRR	MD	MD.BTM	MD.TOP	MFO
		•	•	•				•

**WALL MICROWAVE CABINET,  
18" or 21" HIGH**

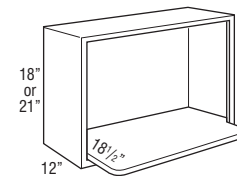

	Opening		Cabinet	
	Width	Height	Width	Height
MW2718	24"	14 1/4"	27"	18"
MW3018	27"	14 1/4"	30"	18"
MW2721	24"	17 1/4"	27"	21"
MW3021	27"	17 1/4"	30"	21"

Model	1	2	3	4	5	6
MW2718	803	803	803	803	803	803
MW3018	803	803	803	803	803	803
MW2721	803	803	803	803	803	803
MW3021	803	803	803	803	803	803

- Includes one 3/4" shelf with six mounting screws. Microwave shelf extends beyond the front of the cabinet by 6 1/2", for a total shelf depth of 18 1/2".
- Microwave cabinet must be attached to wall stud and adjacent cabinets on both sides for support.
- Matching Interior Plywood (MIP) standard.
- When ID is ordered, shelf will not be included with cabinet.
- If ordered with Heirlooming Technique, will not feature sand-through characteristics.

Model	7	8	9	10	11	12	13	14	15	16	17	18
MW2718	803	803	803	803	803	803	803	803	803	803	803	803
MW3018	803	803	803	803	803	803	803	803	803	803	803	803
MW2721	803	803	803	803	803	803	803	803	803	803	803	803
MW3021	803	803	803	803	803	803	803	803	803	803	803	803

**Custom Modifications**

ADDTK	AUTHL AUTHR	CBO	CCO	CFNTO	CFRMO	CND	EXBKL EXBKR	EXL EXR	FB	FFDL FFDR	FPEB	ID	INVFRM	MIP	P	PFINBTMB	RD	TD	TVRAV TVRFV TVRVV	WLI
	•	•	•		•		•	•			•	•		•		•				

**Construction Upgrades**

APC	PE

**Door Options**

ALF	CG	CG.BTM	CG.TOP	DPSRR	MD	MD.BTM	MD.TOP	MFO

MW2436	1856	1903	1944	2023	2039	2081	2161	2176	2264	2326	2422	2520
MW2736	1856	1903	1944	2023	2039	2081	2161	2176	2264	2326	2422	2520
MW3036	1950	2000	2038	2118	2138	2181	2267	2277	2373	2438	2539	2642

MW2439	1837	1884	1925	2003	2019	2060	2139	2154	2241	2303	2398	2495
MW2739	1930	1979	2022	2104	2121	2164	2247	2263	2355	2419	2519	2621
MW3039	1986	2036	2080	2165	2182	2227	2312	2328	2422	2489	2592	2696

MW2442	2004	2055	2100	2185	2202	2247	2334	2350	2445	2512	2616	2722
MW2742	2079	2131	2177	2266	2284	2331	2420	2437	2536	2605	2713	2822
MW3042	2116	2169	2216	2306	2324	2372	2464	2481	2581	2652	2761	2873

**Custom Modifications**

ADDTK	AUTHL AUTHR	CBO	CCO	CFNTO	CFRMO	CND	EXBKL EXBKR	EXL EXR	FB	FFDL FFDR	FPEB	ID	INVFRM	MIP	P	PFINBTMB	RD	TD	TVRAV TVRFV TVRVV	WLI
	•	•	•	•	•		•	•			•	•		•		•				

**Construction Upgrades**

APC	PE

**Door Options**

ALF	CG	CG.BTM	CG.TOP	DPSRR	MD	MD.BTM	MD.TOP	MFO
	•			•				•

**WALL MICROWAVE DOUBLE DOOR  
CABINET, 36", 39", or 42" HIGH**

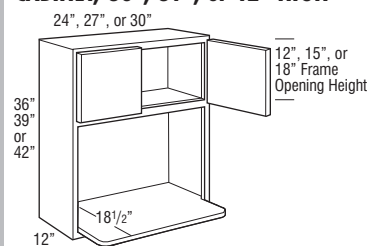

	Opening		Cabinet	
	Width	Height	Width	Height
MW2436	21"	18 3/4"	24"	36"
MW2736	24"	18 3/4"	27"	36"
MW3036	27"	18 3/4"	30"	36"
MW2439	21"	18 3/4"	24"	39"
MW2739	24"	18 3/4"	27"	39"
MW3039	27"	18 3/4"	30"	39"
MW2442	21"	18 3/4"	24"	42"
MW2742	24"	18 3/4"	27"	42"
MW3042	27"	18 3/4"	30"	42"

<b>NEW</b> MW2436	1279	1366	1627	1687	1703	1797
MW2736	1279	1366	1627	1687	1703	1797
MW3036	1346	1437	1705	1771	1791	1886
<b>NEW</b> MW2439	1266	1352	1611	1670	1686	1779
<b>NEW</b> MW2739	1330	1421	1692	1754	1771	1869
<b>NEW</b> MW3039	1369	1462	1741	1805	1822	1923
<b>NEW</b> MW2442	1381	1475	1757	1822	1839	1941
<b>NEW</b> MW2742	1432	1530	1822	1889	1907	2013
<b>NEW</b> MW3042	1458	1557	1855	1923	1941	2049

- Includes one 3/4" shelf with six mounting screws. Microwave shelf extends beyond the front of the cabinet by 6 1/2", for a total shelf depth of 18 1/2".
- Microwave cabinet must be attached to wall stud and adjacent cabinets on both sides for support.
- Matching Interior Plywood (MIP) standard.
- When ID is ordered, shelf will not be included with cabinet.

**WALL BUILT-IN MICROWAVE CABINET,  
18" or 21" HIGH**

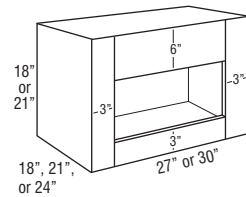

Model	Factory Opening	Maximum Cut-out
2718	21W x 9H	25 1/2W x 15H
2721	21W x 12H	25 1/2W x 18H
3018	24W x 9H	28 1/2W x 15H
3021	24W x 12H	28 1/2W x 18H

Model	1	2	3	4	5	6
<b>WBMW271818</b>	697	697	697	697	697	697
<b>WBMW301818</b>	697	697	697	697	697	697
<b>WBMW272118</b>	697	697	697	697	697	697
<b>WBMW302118</b>	697	697	697	697	697	697
<b>WBMW271821</b>	752	752	752	752	752	752
<b>WBMW301821</b>	752	752	752	752	752	752
<b>WBMW272121</b>	752	752	752	752	752	752
<b>WBMW302121</b>	752	752	752	752	752	752
<b>WBMW271824</b>	828	828	828	828	828	828
<b>WBMW301824</b>	828	828	828	828	828	828
<b>WBMW272124</b>	828	828	828	828	828	828
<b>WBMW302124</b>	828	828	828	828	828	828

- WBMWs can be used to stack with other cabinets to create custom appliance cabinet designs.
- Microwave cabinet must be attached to wall stud and adjacent cabinets on both sides for support.
- If ordered with Heirlooming Technique, will not feature sand-through characteristics.

Model	7	8	9	10	11	12	13	14	15	16	17	18
<b>WBMW271818</b>	697	697	697	697	697	697	697	697	697	697	697	697
<b>WBMW301818</b>	697	697	697	697	697	697	697	697	697	697	697	697
<b>WBMW272118</b>	697	697	697	697	697	697	697	697	697	697	697	697
<b>WBMW302118</b>	697	697	697	697	697	697	697	697	697	697	697	697
<b>WBMW271821</b>	752	752	752	752	752	752	752	752	752	752	752	752
<b>WBMW301821</b>	752	752	752	752	752	752	752	752	752	752	752	752
<b>WBMW272121</b>	752	752	752	752	752	752	752	752	752	752	752	752
<b>WBMW302121</b>	752	752	752	752	752	752	752	752	752	752	752	752
<b>WBMW271824</b>	828	828	828	828	828	828	828	828	828	828	828	828
<b>WBMW301824</b>	828	828	828	828	828	828	828	828	828	828	828	828
<b>WBMW272124</b>	828	828	828	828	828	828	828	828	828	828	828	828
<b>WBMW302124</b>	828	828	828	828	828	828	828	828	828	828	828	828

**Custom Modifications**

ADDTK	AUTHL AUTHR	CBO	CCO	CFNTO	CFRMO	CND	EXBKL EXBKR	EXL EXR	FB	FFDL FFDR	FPEB	ID	INVRM	MIP	P	PFINBTMB	RD	TD	TVRAV TVRFV TVRVV	WLI
	•	STD			•		•	•	•		•	•		•		•	•			•

**Construction Upgrades**

APC	PE
•	•

**Door Options**

ALF	CG	CG.BTM	CG.TOP	DPSRR	MD	MD.BTM	MD.TOP	MFO

**WALL BUILT-IN MICROWAVE DOUBLE DOOR CABINET, 36", 39", or 42" HIGH, 18" or 21" DEEP**

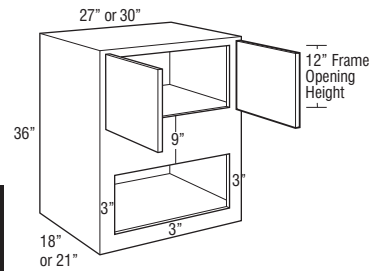

WBMW273618 WBMW273621  
WBMW303618 WBMW303621

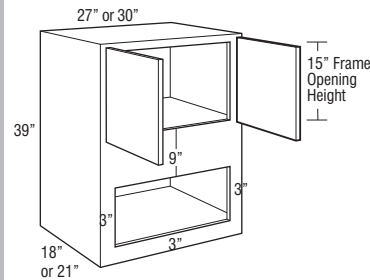

WBMW273918 WBMW273921  
WBMW303918 WBMW303921

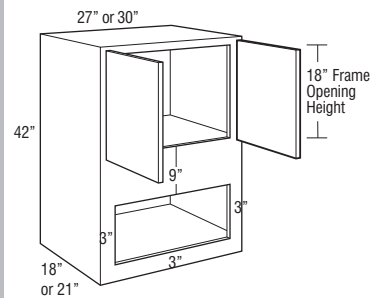

WBMW274218 WBMW274221  
WBMW304218 WBMW304221

Model	Factory Opening	Maximum Cut-out
2736	21W x 10 1/2H	25 1/2W x 19 3/4H
2739	21W x 10 1/2H	25 1/2W x 19 3/4H
2742	21W x 10 1/2H	25 1/2W x 19 3/4H
3036	24W x 10 1/2H	28 1/2W x 19 3/4H
3039	24W x 10 1/2H	28 1/2W x 19 3/4H
3042	24W x 10 1/2H	28 1/2W x 19 3/4H

Model	1	2	3	4	5	6
WBMW273618	782	832	992	1030	1039	1096
WBMW303618	821	875	1040	1081	1091	1150
WBMW273918	861	915	1092	1133	1141	1205
WBMW303918	906	964	1144	1188	1201	1267
WBMW274218	936	998	1190	1233	1248	1315
WBMW304218	986	1050	1249	1297	1310	1381
WBMW273621	835	885	1047	1084	1093	1150
WBMW303621	875	930	1095	1135	1145	1205
WBMW273921	914	969	1146	1187	1198	1260
WBMW303921	960	1018	1200	1245	1255	1321
WBMW274221	991	1052	1247	1290	1302	1371
WBMW304221	1040	1105	1303	1350	1366	1436

- Two 1/4" fillers included, except with FPEB, AUTHL, and AUTHR.
- Microwave cabinet must be attached to wall stud and adjacent cabinets on both sides for support.
- All cabinets have 3" stiles on frames.
- When CG is specified, face frame will be visible through door if used with a translucent art or textured glass design.
- Uses face mount hinges on all styles.

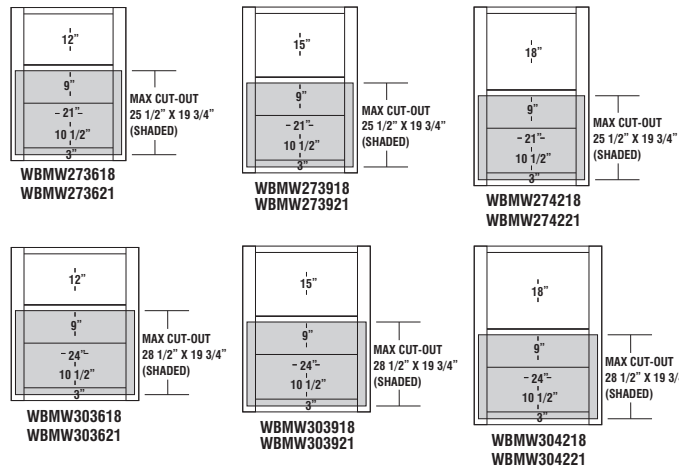

Model	7	8	9	10	11	12	13	14	15	16	17	18
WBMW273618	1133	1163	1184	1232	1245	1269	1319	1328	1381	1420	1478	1539
WBMW303618	1188	1219	1245	1291	1304	1331	1384	1391	1448	1489	1550	1610
WBMW273918	1247	1278	1303	1355	1368	1395	1450	1459	1519	1560	1626	1691
WBMW303918	1308	1341	1368	1421	1435	1463	1521	1529	1594	1636	1704	1773
WBMW274218	1357	1394	1423	1480	1493	1522	1582	1594	1657	1702	1772	1843
WBMW304218	1427	1463	1492	1550	1564	1597	1659	1667	1736	1786	1858	1932
WBMW273621	1187	1217	1241	1289	1298	1324	1374	1382	1436	1473	1534	1594
WBMW303621	1245	1273	1298	1345	1357	1387	1438	1446	1503	1544	1604	1666
WBMW273921	1300	1334	1356	1410	1423	1450	1505	1514	1574	1616	1682	1746
WBMW303921	1363	1395	1423	1475	1490	1518	1576	1583	1647	1691	1757	1830
WBMW274221	1414	1449	1477	1537	1548	1577	1638	1647	1711	1755	1829	1898
WBMW304221	1481	1518	1547	1604	1619	1651	1714	1722	1792	1840	1913	1987

**Custom Modifications**

ADDTK	AUTHL AUTHR	CBO	CCO	CFNTO	CFRMO	CND	EXBKL EXBKR	EXL EXR	FB	FFDL FFDR	FPEB	ID	INVRM	MIP	P	PFINBTMB	RD	TD	TVRAV TVRFV TVRVV	WLI
	•		•				•	•	•		•	•		•		•				•

**Construction Upgrades**

APC	PE
•	•

**Door Options**

ALF	CG	CG.BTM	CG.TOP	DPSRR	MD	MD.BTM	MD.TOP	MFO
	•			•				•

**WALL APPLIANCE GARAGE DOOR, 18" HIGH, 12" DEEP**

12", 15", 18", 21", or 24"

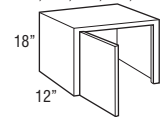

24", 27", 30", 33", or 36"

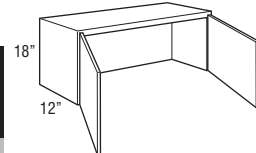

Model	1	2	3	4	5	6
<b>WAGD12 L or R</b>	728	728	728	728	728	728
<b>WAGD15 L or R</b>	751	751	751	751	751	751
<b>WAGD18 L or R</b>	773	773	773	773	773	773
<b>WAGD21 L or R</b>	794	794	794	794	794	794
<b>WAGD24 L or R</b>	834	834	834	834	834	834
<hr/>						
<b>WAGD24</b>	875	875	875	875	875	875
<b>WAGD27</b>	903	903	903	903	903	903
<b>WAGD30</b>	929	929	929	929	929	929
<b>WAGD33</b>	958	958	958	958	958	958
<b>WAGD36</b>	986	986	986	986	986	986

- Cabinet does not have floor.
- When ordered in Arch door styles, door will be Square.

**WALL APPLIANCE GARAGE VERTICAL-LIFT DOOR, 18" HIGH, 12" DEEP**

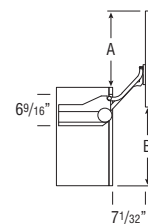
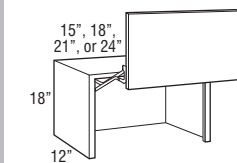

	Full Overlay	Partial Overlay
<b>A</b>	16 13/16"	16 1/16"
<b>B</b>	17 5/16"	18 1/16"

<b>WAGVLD15</b>	1525	1557	1622	1706	1731	1766
<b>WAGVLD18</b>	1571	1603	1668	1752	1777	1812
<b>WAGVLD21</b>	1617	1649	1714	1798	1822	1858
<b>WAGVLD24</b>	1663	1695	1760	1844	1868	1904

- Utilizes standard doors with vertical grain on center panel and standard door configuration. Gallo will have standard vertical grain pattern. Derazi will have standard horizontal grain pattern.
- When ordered in Arch door styles, door will be Square.
- Decorative hardware required.
- See side view drawing for required clearances.
- Lift mechanism features a single motion for up and out movement with Smart Stop, tension can be field adjusted.
- Lift mechanisms and mounting brackets will be visible if used with transparent textured glass.
- Lift mechanism not available for order for field installation, only available factory installed.
- Hardware extends 1" into opening on each side.
- Bottom edge not trimmable.

**CORNER DOOR, 18" HIGH**

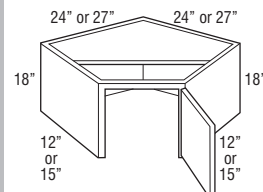

<b>CD2424 L or R</b>	833	833	833	833	833	833
<hr/>						
<b>CD2727 L or R</b>	1084	1084	1084	1084	1084	1084

- CD2424 L or R requires 24" x 24" corner wall space.
- CD2727 L or R requires 27" x 27" corner wall space.
- Cabinet is designed to fit beneath Diagonal Wall Cabinets.
- When ordered in Arch door styles, door will be Square.
- Cabinet has partial top and no floor.
- Full overlay styles use the same width doors as partial overlay styles (14 1/2" wide) with a partial overlay hinge (38NPOHINGE) to allow for proper door clearance with adjacent cabinets.

Model	7	8	9	10	11	12	13	14	15	16	17	18
<b>WAGD12 L or R</b>	728	728	728	728	728	728	728	728	728	728	728	728
<b>WAGD15 L or R</b>	751	751	751	751	751	751	751	751	751	751	751	751
<b>WAGD18 L or R</b>	773	773	773	773	773	773	773	773	773	773	773	773
<b>WAGD21 L or R</b>	794	794	794	794	794	794	794	794	794	794	794	794
<b>WAGD24 L or R</b>	834	834	834	834	834	834	834	834	834	834	834	834
<hr/>												
<b>WAGD24</b>	875	875	875	875	875	875	875	875	875	875	875	875
<b>WAGD27</b>	903	903	903	903	903	903	903	903	903	903	903	903
<b>WAGD30</b>	929	929	929	929	929	929	929	929	929	929	929	929
<b>WAGD33</b>	958	958	958	958	958	958	958	958	958	958	958	958
<b>WAGD36</b>	986	986	986	986	986	986	986	986	986	986	986	986

**Custom Modifications**

ADDTK	AUTHL AUTHR	CBO	CCO	CFNTO	CFRMO	CND	EXBKL EXBKR	EXL EXR	FB	FFDL FFDR	FPEB	ID	INVERM	MIP	P	PFINBTMB	RD	TD	TVRAV TVRFV TVRVV	WLI	
	•		•	•	•		•	•	STD		•	•		•					•		•

**Construction Upgrades**

APC	PE
•	STD

**Door Options**

ALF	CG	CG.BTM	CG.TOP	DPSRR	MD	MD.BTM	MD.TOP	MFO
	•			•				

<b>WAGVLD15</b>	1765	1806	1818	1851	1856	1874	1904	1907	1939	1964	2002	2036
<b>WAGVLD18</b>	1811	1852	1864	1897	1902	1919	1950	1953	1985	2010	2048	2082
<b>WAGVLD21</b>	1857	1898	1910	1943	1948	1965	1996	1999	2031	2056	2094	2128
<b>WAGVLD24</b>	1903	1944	1956	1989	1994	2011	2042	2045	2077	2102	2140	2174

**Custom Modifications**

ADDTK	AUTHL AUTHR	CBO	CCO	CFNTO	CFRMO	CND	EXBKL EXBKR	EXL EXR	FB	FFDL FFDR	FPEB	ID	INVERM	MIP	P	PFINBTMB	RD	TD	TVRAV TVRFV TVRVV	WLI	
	•		•		•		•	•	•		•	•		•					•		•

**Construction Upgrades**

APC	PE
•	•

**Door Options**

ALF	CG	CG.BTM	CG.TOP	DPSRR	MD	MD.BTM	MD.TOP	MFO
	•			•				

<b>CD2424 L or R</b>	833	833	833	833	833	833	833	833	833	833	833	833
<hr/>												
<b>CD2727 L or R</b>	1084	1084	1084	1084	1084	1084	1084	1084	1084	1084	1084	1084

**Custom Modifications**

ADDTK	AUTHL AUTHR	CBO	CCO	CFNTO	CFRMO	CND	EXBKL EXBKR	EXL EXR	FB	FFDL FFDR	FPEB	ID	INVERM	MIP	P	PFINBTMB	RD	TD	TVRAV TVRFV TVRVV	WLI	
	•		•	•	•				•		•	•		•					•		•

**Construction Upgrades**

APC	PE
•	•

**Door Options**

ALF	CG	CG.BTM	CG.TOP	DPSRR	MD	MD.BTM	MD.TOP	MFO
	•			•				

**WALL BOX COLUMN PULL-OUT, PLAIN**

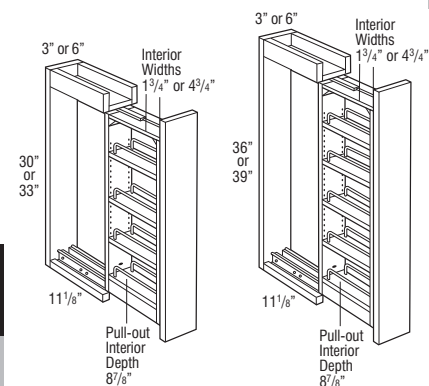

WBCPO\_30  
WBCPO\_33

WBCPO\_36  
WBCPO\_39

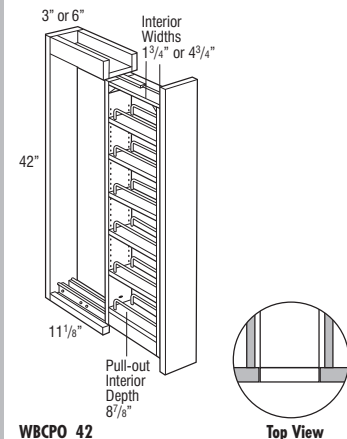

WBCPO\_42

Top View

Model	1	2	3	4	5	6
WBCPO330	733	733	733	733	733	733
WBCPO333	789	789	789	789	789	789
WBCPO336	845	845	845	845	845	845
WBCPO339	901	901	901	901	901	901
WBCPO342	957	957	957	957	957	957
WBCPO630	940	940	940	940	940	940
WBCPO633	996	996	996	996	996	996
WBCPO636	1052	1052	1052	1052	1052	1052
WBCPO639	1108	1108	1108	1108	1108	1108
WBCPO642	1164	1164	1164	1164	1164	1164

- Recommend installation between two cabinets. Can be installed on the end of a run or adjacent to an appliance with a 3/4" thick end panel.
- All styles feature a natural finish full extension wood pull-out with adjustable shelves and chrome rail sides.
- If ordered with Heirlooming Technique, will not feature sand-through characteristics.
- In order to allow proper clearance for opening and closing, allow an additional 1/8" space between adjacent cabinet face frames. The 3" wide pull-outs require 3 1/8" space and the 6" wide pull-outs require 6 1/8" space. Spacers are included with the pull-outs to allow for proper installation.
- For full access from both sides of unit, do not install against a wall or next to deeper appliances and cabinets.

**WALL BOX COLUMN PULL-OUT, OVERLAY**

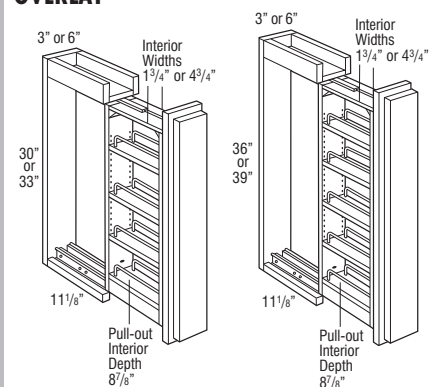

WBCPO\_300L  
WBCPO\_330L

WBCPO\_360L  
WBCPO\_390L

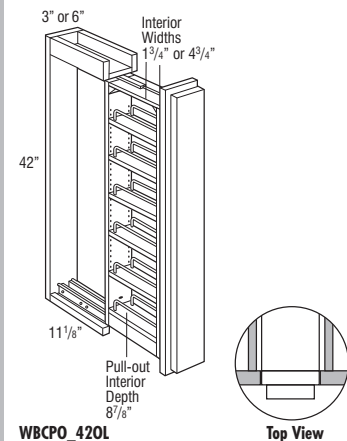

WBCPO\_420L

Top View

WBCPO3300L	785	785	785	785	785	785
WBCPO3330L	841	841	841	841	841	841
WBCPO3360L	897	897	897	897	897	897
WBCPO3390L	953	953	953	953	953	953
WBCPO3420L	1009	1009	1009	1009	1009	1009
WBCPO6300L	992	992	992	992	992	992
WBCPO6330L	1048	1048	1048	1048	1048	1048
WBCPO6360L	1104	1104	1104	1104	1104	1104
WBCPO6390L	1160	1160	1160	1160	1160	1160
WBCPO6420L	1216	1216	1216	1216	1216	1216

- Recommend installation between two cabinets. Can be installed on the end of a run or adjacent to an appliance with a 3/4" thick end panel.
- Overlay application includes profiled full overlay filler.
- All styles feature a natural finish full extension wood pull-out with adjustable shelves and chrome rail sides.
- In order to allow proper clearance for opening and closing, allow an additional 1/8" space between adjacent cabinet face frames. The 3" wide pull-outs require 3 1/8" space and the 6" wide pull-outs require 6 1/8" space. Spacers are included with the pull-outs to allow for proper installation.
- For full access from both sides of unit, do not install against a wall or next to deeper appliances and cabinets.
- Not compatible with face mount moulding.

Model	7	8	9	10	11	12	13	14	15	16	17	18
WBCPO330	733	733	733	733	733	733	733	733	733	733	733	733
WBCPO333	789	789	789	789	789	789	789	789	789	789	789	789
WBCPO336	845	845	845	845	845	845	845	845	845	845	845	845
WBCPO339	901	901	901	901	901	901	901	901	901	901	901	901
WBCPO342	957	957	957	957	957	957	957	957	957	957	957	957
WBCPO630	940	940	940	940	940	940	940	940	940	940	940	940
WBCPO633	996	996	996	996	996	996	996	996	996	996	996	996
WBCPO636	1052	1052	1052	1052	1052	1052	1052	1052	1052	1052	1052	1052
WBCPO639	1108	1108	1108	1108	1108	1108	1108	1108	1108	1108	1108	1108
WBCPO642	1164	1164	1164	1164	1164	1164	1164	1164	1164	1164	1164	1164

**MODIFICATIONS**

No modifications available for these products.

**Finish Techniques**

Distressing	Heirlooming
•	

WBCPO3300L	785	785	785	785	785	785	785	785	785	785	785	785
WBCPO3330L	841	841	841	841	841	841	841	841	841	841	841	841
WBCPO3360L	897	897	897	897	897	897	897	897	897	897	897	897
WBCPO3390L	953	953	953	953	953	953	953	953	953	953	953	953
WBCPO3420L	1009	1009	1009	1009	1009	1009	1009	1009	1009	1009	1009	1009
WBCPO6300L	992	992	992	992	992	992	992	992	992	992	992	992
WBCPO6330L	1048	1048	1048	1048	1048	1048	1048	1048	1048	1048	1048	1048
WBCPO6360L	1104	1104	1104	1104	1104	1104	1104	1104	1104	1104	1104	1104
WBCPO6390L	1160	1160	1160	1160	1160	1160	1160	1160	1160	1160	1160	1160
WBCPO6420L	1216	1216	1216	1216	1216	1216	1216	1216	1216	1216	1216	1216

**MODIFICATIONS**

No modifications available for these products.

**Finish Techniques**

Distressing	Heirlooming
•	•

**WALL BOX COLUMN PULL-OUT with K-CUP\*, PLAIN**

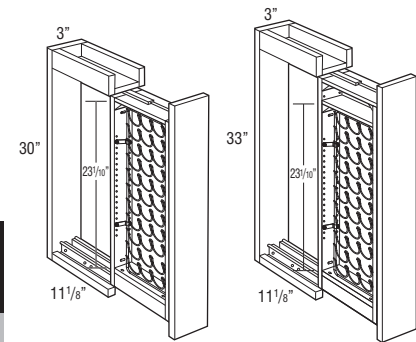

WBCPOKCUP330 WBCPOKCUP333

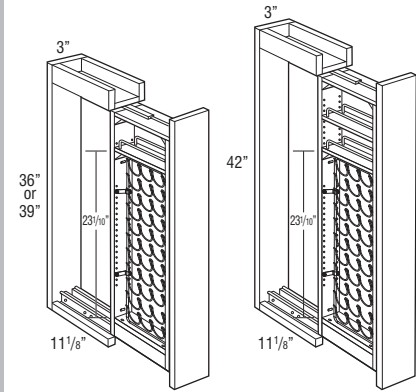

WBCPOKCUP336 WBCPOKCUP339 WBCPOKCUP342

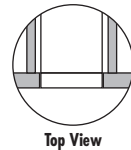

Top View

Model	1	2	3	4	5	6
WBCPOKCUP330	856	856	856	856	856	856
WBCPOKCUP333	912	912	912	912	912	912
WBCPOKCUP336	968	968	968	968	968	968
WBCPOKCUP339	1024	1024	1024	1024	1024	1024
WBCPOKCUP342	1080	1080	1080	1080	1080	1080

- Holds 44 K-Cups, compatible with K-Cup pods only.
- Wire K-Cup rack included for easy field installation on either the left or right side (K-Cups are only accessible from one side). All units include adjustable shelves with chrome rail sides that can be used for future installation if K-Cup insert is no longer desired. Depending on height of pull-out, shelves can be used above or below insert for additional storage:  
30" & 33" high include 4 shelves, not compatible with insert.  
36" & 39" high include 5 shelves, one shelf recommended for use with insert.  
42" high includes 6 shelves, two shelves recommended for use with insert.
- Recommend installation between two cabinets. Can be installed on the end of a run or adjacent to an appliance with a 3/4" thick end panel.
- All styles feature a natural finish full extension wood pull-out.
- In order to allow proper clearance for opening and closing, allow an additional 1/8" space between adjacent cabinet face frames. The 3" wide pull-outs require 3 1/8" space. Spacers are included with the pull-outs to allow for proper installation.
- For full access of upper shelves from both sides of unit, do not install against a wall or next to deeper appliances and cabinets.
- Finger pull routed on bottom edge of wall unit. Hardware optional.
- Pull-out does not have Smart Stop feature.

\*K-Cup is a registered trademark of Keurig Green Mountain, Inc.

**WALL BOX COLUMN PULL-OUT with K-CUP\*, OVERLAY**

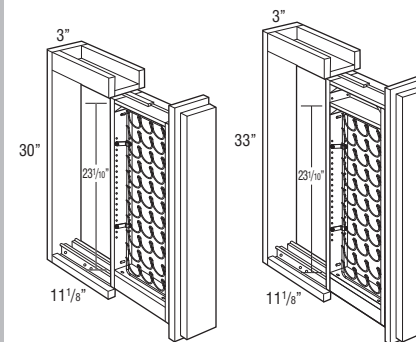

WBCPOKCUP330OL WBCPOKCUP333OL

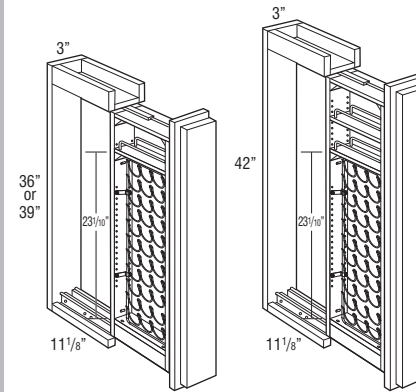

WBCPOKCUP336OL WBCPOKCUP339OL WBCPOKCUP342OL

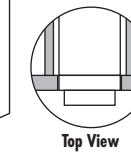

Top View

Model	1	2	3	4	5	6
WBCPOKCUP330OL	908	908	908	908	908	908
WBCPOKCUP333OL	964	964	964	964	964	964
WBCPOKCUP336OL	1020	1020	1020	1020	1020	1020
WBCPOKCUP339OL	1076	1076	1076	1076	1076	1076
WBCPOKCUP342OL	1132	1132	1132	1132	1132	1132

- Holds 44 K-Cups, compatible with K-Cup pods only.
- Wire K-Cup rack included for easy field installation on either the left or right side (K-Cups are only accessible from one side). All units include adjustable shelves with chrome rail sides that can be used for future installation if K-Cup insert is no longer desired. Depending on height of pull-out, shelves can be used above or below insert for additional storage:  
30" & 33" high include 4 shelves, not compatible with insert.  
36" & 39" high include 5 shelves, one shelf recommended for use with insert.  
42" high includes 6 shelves, two shelves recommended for use with insert.
- Overlay application includes profiled full overlay filler.
- Recommend installation between two cabinets. Can be installed on the end of a run or adjacent to an appliance with a 3/4" thick end panel.
- All styles feature a natural finish full extension wood pull-out.
- In order to allow proper clearance for opening and closing, allow an additional 1/8" space between adjacent cabinet face frames. The 3" wide pull-outs require 3 1/8" space. Spacers are included with the pull-outs to allow for proper installation.
- For full access of upper shelves from both sides of unit, do not install against a wall or next to deeper appliances and cabinets.
- Finger pull routed on bottom edge of wall unit. Hardware optional.
- Pull-out does not have Smart Stop feature.
- Not compatible with face mount moulding.

\*K-Cup is a registered trademark of Keurig Green Mountain, Inc.

Model	7	8	9	10	11	12	13	14	15	16	17	18
WBCPOKCUP330	856	856	856	856	856	856	856	856	856	856	856	856
WBCPOKCUP333	912	912	912	912	912	912	912	912	912	912	912	912
WBCPOKCUP336	968	968	968	968	968	968	968	968	968	968	968	968
WBCPOKCUP339	1024	1024	1024	1024	1024	1024	1024	1024	1024	1024	1024	1024
WBCPOKCUP342	1080	1080	1080	1080	1080	1080	1080	1080	1080	1080	1080	1080

**MODIFICATIONS**

No modifications available for these products.

**Finish Techniques**

Distressing	Heirlooming
•	

Model	1	2	3	4	5	6	7	8	9	10	11	12	13	14	15	16	17	18
WBCPOKCUP330OL	908	908	908	908	908	908	908	908	908	908	908	908	908	908	908	908	908	908
WBCPOKCUP333OL	964	964	964	964	964	964	964	964	964	964	964	964	964	964	964	964	964	964
WBCPOKCUP336OL	1020	1020	1020	1020	1020	1020	1020	1020	1020	1020	1020	1020	1020	1020	1020	1020	1020	1020
WBCPOKCUP339OL	1076	1076	1076	1076	1076	1076	1076	1076	1076	1076	1076	1076	1076	1076	1076	1076	1076	1076
WBCPOKCUP342OL	1132	1132	1132	1132	1132	1132	1132	1132	1132	1132	1132	1132	1132	1132	1132	1132	1132	1132

**MODIFICATIONS**

No modifications available for these products.

**Finish Techniques**

Distressing	Heirlooming
•	•



**WALL SPICE PULL-OUT, 30", 33", 36", 39", or 42" HIGH**

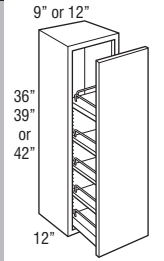
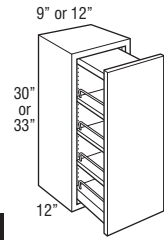

Model	1	2	3	4	5	6
<b>WSP930</b>	794	819	873	903	955	980
<b>WSP1230</b>	848	869	914	961	1001	1026
<b>WSP933</b>	837	864	918	959	1005	1033
<b>WSP1233</b>	890	915	965	1017	1062	1088
<b>WSP936</b>	882	909	961	1016	1056	1084
<b>WSP1236</b>	931	959	1014	1073	1122	1148
<b>WSP939</b>	921	951	1010	1070	1112	1144
<b>WSP1239</b>	974	1004	1064	1129	1181	1212
<b>WSP942</b>	962	997	1056	1123	1179	1204
<b>WSP1242</b>	1015	1048	1114	1182	1244	1279

- 30" and 33" high units include a natural finish, full extension wood pull-out with three adjustable shelves, one fixed shelf, and chrome finish rail sides.
- Wood plugs for top of 30" high pull-out included for field installation.
- 36" to 42" high units include a natural finish, full extension wood pull-out with three adjustable shelves, two fixed shelves, and chrome finish rail sides.
- Wire for top rail on 36" to 42" high pull-out included separately for field installation.
- For full access from both sides of unit, do not install against a wall or next to deeper appliances and cabinets.
- Pull-out does not have Smart Stop feature.

**WALL SPICE PULL-DOWN**

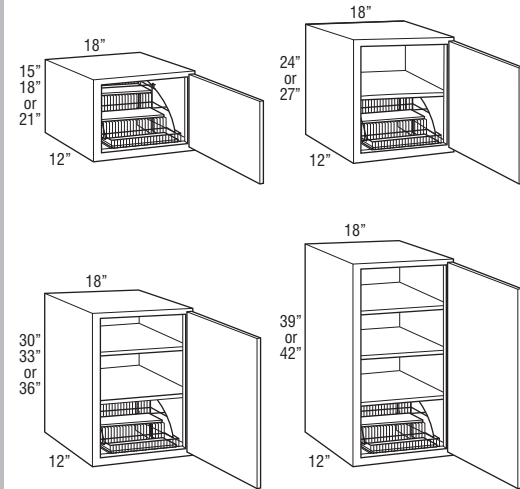

<b>W1815SPD L or R</b>	578	602	663	730	757	783
<b>W1818SPD L or R</b>	607	630	698	771	802	827
<b>W1821SPD L or R</b>	621	644	705	764	802	831
<b>W1824SPD L or R</b>	564	584	650	691	702	725
<b>W1827SPD L or R</b>	601	628	693	753	787	815
<b>W1830SPD L or R</b>	595	618	679	753	771	800
<b>W1833SPD L or R</b>	643	672	734	816	841	868
<b>W1836SPD L or R</b>	692	723	791	882	908	939
<b>W1839SPD L or R</b>	739	773	847	947	977	1012
<b>W1842SPD L or R</b>	788	827	904	1014	1040	1081

- Spice Rack Pull-down dimensions: 8 15/16" high x 14 13/16" wide x 10 5/16" deep.
- Interior dimensions of pull-down trays: 11 3/4" wide x 3" deep.
- Maximum Weight Capacity for Spice Rack Pull-down: 15 lbs.
- Extends 3 3/4" below and 9 1/4" in front of the cabinet box when fully extended.
- When Increased Depth (ID) is ordered, insert will not increase in size.

Model	7	8	9	10	11	12	13	14	15	16	17	18
<b>WSP930</b>	946	1009	1017	1041	1045	1056	1080	1082	1107	1123	1150	1176
<b>WSP1230</b>	1007	1057	1068	1089	1092	1080	1130	1132	1160	1191	1219	1247
<b>WSP933</b>	1009	1065	1075	1101	1106	1117	1143	1146	1172	1193	1221	1250
<b>WSP1233</b>	1067	1123	1135	1156	1162	1163	1203	1207	1237	1264	1295	1326
<b>WSP936</b>	1070	1120	1133	1160	1165	1179	1204	1210	1240	1261	1293	1324
<b>WSP1236</b>	1129	1187	1199	1226	1231	1247	1275	1280	1315	1335	1372	1403
<b>WSP939</b>	1128	1184	1197	1227	1234	1248	1275	1281	1315	1339	1372	1408
<b>WSP1239</b>	1191	1254	1269	1298	1302	1322	1351	1356	1393	1420	1455	1495
<b>WSP942</b>	1189	1248	1266	1296	1304	1319	1354	1357	1394	1418	1458	1498
<b>WSP1242</b>	1249	1328	1343	1378	1384	1400	1438	1442	1480	1507	1549	1591

**Custom Modifications**

ADDTK	AUTHL AUTHR	CBO	CCO	CFNTO	CFRMO	CND	EXBKL EXBKR	EXL EXR	FB	FFDL FFDR	FPEB	ID	INVFRM	MIP	P	PFINBTMB	RD	TD	TVRAV TVRFV TVRVV	WLI
•	•	•	•		•		•	•	•		•			•		•				•

**Construction Upgrades**

APC	PE
•	•

**Door Options**

ALF	CG	CG.BTM	CG.TOP	DPSRR	MD	MD.BTM	MD.TOP	MFO
				•				•

<b>W1815SPD L or R</b>	780	815	828	848	856	868	894	896	926	945	975	1006
<b>W1818SPD L or R</b>	826	861	876	902	906	920	946	952	982	1003	1035	1066
<b>W1821SPD L or R</b>	820	867	884	908	913	927	955	958	989	1011	1045	1076
<b>W1824SPD L or R</b>	738	754	763	787	790	802	825	828	854	868	895	922
<b>W1827SPD L or R</b>	805	854	864	891	896	908	937	941	969	989	1022	1053
<b>W1830SPD L or R</b>	805	837	846	872	878	889	918	920	948	969	998	1030
<b>W1833SPD L or R</b>	877	909	923	952	957	971	1004	1006	1038	1060	1095	1131
<b>W1836SPD L or R</b>	947	984	998	1031	1037	1054	1090	1091	1125	1151	1190	1227
<b>W1839SPD L or R</b>	1018	1059	1074	1109	1116	1138	1174	1176	1216	1244	1285	1327
<b>W1842SPD L or R</b>	1094	1134	1150	1187	1194	1215	1253	1258	1302	1328	1373	1421

**Custom Modifications**

ADDTK	AUTHL AUTHR	CBO	CCO	CFNTO	CFRMO	CND	EXBKL EXBKR	EXL EXR	FB	FFDL FFDR	FPEB	ID	INVFRM	MIP	P	PFINBTMB	RD	TD	TVRAV TVRFV TVRVV	WLI
•	•	•*	•		•		•	•	•		•			•		•				•

\*Not available on 15", 18", or 21" high

\*Not available on 15" high

**Construction Upgrades**

APC	PE
•	•

**Door Options**

ALF	CG	CG.BTM	CG.TOP	DPSRR	MD	MD.BTM	MD.TOP	MFO
				•	• <sup>i</sup>			•

<sup>i</sup>Not available on 15", 24", or 27" high

**WALL SHELF PULL-DOWN**

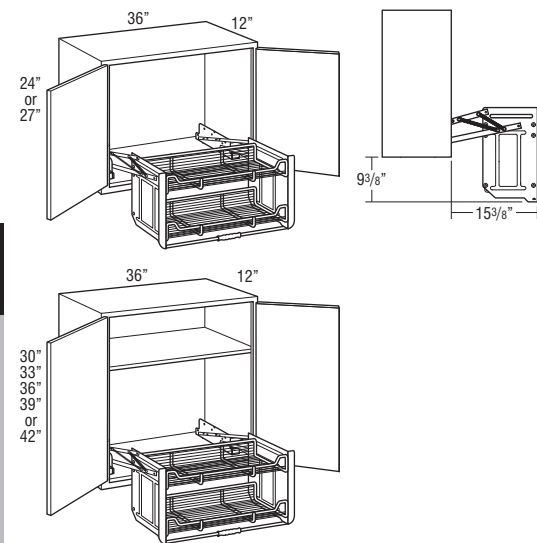

Model	1	2	3	4	5	6
<b>W3624SHLFPD</b>	1568	1603	1717	1804	1833	1880
<b>W3627SHLFPD</b>	1595	1633	1740	1851	1884	1930
<b>W3630SHLFPD</b>	1622	1661	1770	1898	1932	1979
<b>W3633SHLFPD</b>	1704	1750	1863	2004	2044	2096
<b>W3636SHLFPD</b>	1784	1838	1956	2108	2157	2215
<b>W3639SHLFPD</b>	1860	1918	2051	2219	2272	2334
<b>W3642SHLFPD</b>	1954	2013	2145	2319	2387	2457

- Shelf Pull-down dimensions: 18 11/64" high x 28 1/4" wide x 8 1/2" deep.
- Interior dimensions of pull-down trays: 28 1/4" wide x 8 1/2" deep.
- Clearance dimensions: 19 3/8" high x 15 3/8" wide.
- 30" to 42" high units will have one adjustable shelf above pull-down unit.
- Maximum Weight Capacity for Shelf Pull-down: 26 lbs.

**WALL SPICE RACK CABINET, 30", 33", 36", 39", or 42" HIGH**

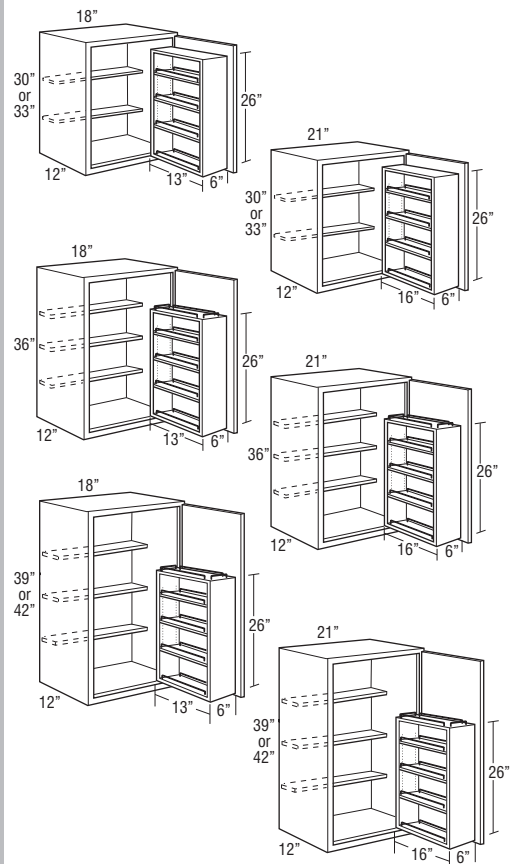

<b>WSR1830 L or R</b>	1092	1119	1137	1262	1371	1430
<b>WSR2130 L or R</b>	1124	1147	1178	1300	1423	1482
<b>WSR1833 L or R</b>	1119	1172	1190	1328	1441	1503
<b>WSR2133 L or R</b>	1157	1209	1238	1372	1495	1558
<b>WSR1836 L or R</b>	1146	1225	1245	1393	1509	1575
<b>WSR2136 L or R</b>	1188	1269	1297	1442	1566	1634
<b>WSR1839 L or R</b>	1144	1218	1327	1494	1624	1692
<b>WSR2139 L or R</b>	1239	1317	1391	1558	1689	1765
<b>WSR1842 L or R</b>	1163	1235	1346	1516	1649	1718
<b>WSR2142 L or R</b>	1256	1338	1410	1582	1714	1792

- Shelves are 4 1/2" deep.
- Field installed swing-out has three adjustable and one fixed bottom shelf with chrome finish wire rail sides.
- Dimensions: WSR18 wood insert is 26" high x 13" wide x 6" deep. WSR21 wood insert is 26" high x 16" wide x 6" deep.
- When Increased Depth (ID) is ordered, wood insert will not increase in size.
- Maximum Weight Capacity for Spice Rack Shelves: 15 lbs.

Model	7	8	9	10	11	12	13	14	15	16	17	18
<b>W3624SHLFPD</b>	1883	1929	1945	1983	1990	2011	2050	2056	2100	2127	2174	2220
<b>W3627SHLFPD</b>	1934	1983	2004	2040	2050	2071	2112	2117	2162	2194	2243	2292
<b>W3630SHLFPD</b>	1986	2035	2056	2098	2106	2127	2173	2181	2229	2259	2310	2361
<b>W3633SHLFPD</b>	2103	2159	2184	2232	2241	2265	2316	2322	2375	2413	2470	2527
<b>W3636SHLFPD</b>	2219	2286	2310	2362	2374	2401	2458	2465	2524	2566	2627	2694
<b>W3639SHLFPD</b>	2339	2412	2440	2496	2511	2539	2601	2610	2675	2719	2789	2859
<b>W3642SHLFPD</b>	2449	2542	2572	2636	2648	2679	2748	2758	2828	2876	2956	3032

**Custom Modifications**

ADDTK	AUTHL AUTHR	CBO	CCO	CFNTO	CFRMO	CND	EXBKL EXBKR	EXL EXR	FB	FFDL FFDR	FPEB	ID	INVFRM	MIP	P	PFINBTMB	RD	TD	TVRAV TVRFV TVRVV	WLI
	•	•	•	•	•		•	•	•		•			•		•				•

**Construction Upgrades**

APC	PE
•	•

**Door Options**

ALF	CG	CG.BTM	CG.TOP	DPSRR	MD	MD.BTM	MD.TOP	MFO
	•			•	•			•

<b>WSR1830 L or R</b>	1389	1515	1546	1605	1623	1654	1718	1728	1798	1849	1925	2003
<b>WSR2130 L or R</b>	1430	1574	1603	1667	1683	1715	1785	1795	1870	1921	2001	2081
<b>WSR1833 L or R</b>	1459	1593	1624	1689	1704	1739	1806	1813	1890	1944	2024	2103
<b>WSR2133 L or R</b>	1508	1654	1685	1752	1768	1803	1874	1886	1963	2015	2100	2184
<b>WSR1836 L or R</b>	1534	1667	1702	1771	1786	1825	1895	1901	1982	2037	2122	2206
<b>WSR2136 L or R</b>	1588	1732	1767	1837	1852	1892	1964	1975	2056	2112	2202	2289
<b>WSR1839 L or R</b>	1644	1797	1830	1902	1918	1957	2037	2045	2129	2191	2278	2372
<b>WSR2139 L or R</b>	1715	1869	1908	1983	2002	2041	2122	2131	2220	2278	2376	2470
<b>WSR1842 L or R</b>	1668	1825	1856	1931	1949	1986	2067	2077	2161	2224	2315	2409
<b>WSR2142 L or R</b>	1742	1898	1938	2012	2032	2074	2153	2163	2256	2315	2412	2508

**Custom Modifications**

ADDTK	AUTHL AUTHR	CBO	CCO	CFNTO	CFRMO	CND	EXBKL EXBKR	EXL EXR	FB	FFDL FFDR	FPEB	ID	INVFRM	MIP	P	PFINBTMB	RD	TD	TVRAV TVRFV TVRVV	WLI
•	•	•	•	•	•		•	•	•		•			•		•				•

**Construction Upgrades**

APC	PE
•	•

**Door Options**

ALF	CG	CG.BTM	CG.TOP	DPSRR	MD	MD.BTM	MD.TOP	MFO
	•			•	•			•

**WALL OPEN CABINET with PLAIN BACK, 30", 33", 36", 39", or 42" HIGH**

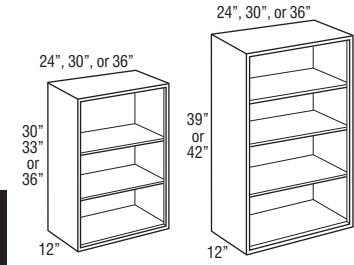

Model	1	2	3	4	5	6
WOCP2430	1212	1212	1212	1212	1212	1212
WOCP3030	1272	1272	1272	1272	1272	1272
WOCP3630	1334	1334	1334	1334	1334	1334
WOCP2433	1292	1292	1292	1292	1292	1292
WOCP3033	1355	1355	1355	1355	1355	1355
WOCP3633	1424	1424	1424	1424	1424	1424
WOCP2436	1373	1373	1373	1373	1373	1373
WOCP3036	1441	1441	1441	1441	1441	1441
WOCP3636	1512	1512	1512	1512	1512	1512
WOCP2439	1392	1392	1392	1392	1392	1392
WOCP3039	1461	1461	1461	1461	1461	1461
WOCP3639	1534	1534	1534	1534	1534	1534
WOCP2442	1392	1392	1392	1392	1392	1392
WOCP3042	1461	1461	1461	1461	1461	1461
WOCP3642	1534	1534	1534	1534	1534	1534

- Matching Interior Plywood (MIP) standard.
- Face frame has a profiled inside edge.
- If ordered with Heirlooming Technique, will not feature sand-through characteristics.
- To change the top rail valance, specify one of the following modifications: Arch (TVRAV), Furniture (TVRFV), or Straight Valance (TVRVV).

Model	7	8	9	10	11	12	13	14	15	16	17	18
WOCP2430	1212	1212	1212	1212	1212	1212	1212	1212	1212	1212	1212	1212
WOCP3030	1272	1272	1272	1272	1272	1272	1272	1272	1272	1272	1272	1272
WOCP3630	1334	1334	1334	1334	1334	1334	1334	1334	1334	1334	1334	1334
WOCP2433	1292	1292	1292	1292	1292	1292	1292	1292	1292	1292	1292	1292
WOCP3033	1355	1355	1355	1355	1355	1355	1355	1355	1355	1355	1355	1355
WOCP3633	1424	1424	1424	1424	1424	1424	1424	1424	1424	1424	1424	1424
WOCP2436	1373	1373	1373	1373	1373	1373	1373	1373	1373	1373	1373	1373
WOCP3036	1441	1441	1441	1441	1441	1441	1441	1441	1441	1441	1441	1441
WOCP3636	1512	1512	1512	1512	1512	1512	1512	1512	1512	1512	1512	1512
WOCP2439	1392	1392	1392	1392	1392	1392	1392	1392	1392	1392	1392	1392
WOCP3039	1461	1461	1461	1461	1461	1461	1461	1461	1461	1461	1461	1461
WOCP3639	1534	1534	1534	1534	1534	1534	1534	1534	1534	1534	1534	1534
WOCP2442	1392	1392	1392	1392	1392	1392	1392	1392	1392	1392	1392	1392
WOCP3042	1461	1461	1461	1461	1461	1461	1461	1461	1461	1461	1461	1461
WOCP3642	1534	1534	1534	1534	1534	1534	1534	1534	1534	1534	1534	1534

**Custom Modifications**

ADDTK	AUTHL AUTHR	CBO	CCO	CFNTO	CFRMO	CND	EXBKL EXBKR	EXL EXR	FB	FFDL FFDR	FPEB	ID	INVFRM	MIP	P	PFINBTMB	RD	TD	TVRAV TVRFV TVRVV	WLI
•	•	STD			•		•	•			•	•		STD	•	•	•		•	

**Construction Upgrades**

APC	PE

**Door Options**

ALF	CG	CG.BTM	CG.TOP	DPSRR	MD	MD.BTM	MD.TOP	MFO

**WALL OPEN CABINET with BEADED BACK, 30", 33", 36", 39", or 42" HIGH**

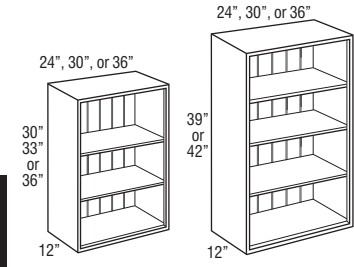

Model	1	2	3	4	5	6
WOCB2430	1212	1212	1212	1212	1212	1212
WOCB3030	1272	1272	1272	1272	1272	1272
WOCB3630	1334	1334	1334	1334	1334	1334
WOCB2433	1292	1292	1292	1292	1292	1292
WOCB3033	1355	1355	1355	1355	1355	1355
WOCB3633	1424	1424	1424	1424	1424	1424
WOCB2436	1373	1373	1373	1373	1373	1373
WOCB3036	1441	1441	1441	1441	1441	1441
WOCB3636	1512	1512	1512	1512	1512	1512
WOCB2439	1392	1392	1392	1392	1392	1392
WOCB3039	1461	1461	1461	1461	1461	1461
WOCB3639	1534	1534	1534	1534	1534	1534
WOCB2442	1392	1392	1392	1392	1392	1392
WOCB3042	1461	1461	1461	1461	1461	1461
WOCB3642	1534	1534	1534	1534	1534	1534

- Matching Interior Plywood (MIP) standard.
- Beaded back panel is veneer on furniture board core.
- Face frame has a profiled inside edge.
- If ordered with Heirlooming Technique, will not feature sand-through characteristics.
- To change the top rail valance, specify one of the following modifications: Arch (TVRAV), Furniture (TVRFV), or Straight Valance (TVRVV).

Model	7	8	9	10	11	12	13	14	15	16	17	18
WOCB2430	1212	1212	1212	1212	1212	1212	1212	1212	1212	1212	1212	1212
WOCB3030	1272	1272	1272	1272	1272	1272	1272	1272	1272	1272	1272	1272
WOCB3630	1334	1334	1334	1334	1334	1334	1334	1334	1334	1334	1334	1334
WOCB2433	1292	1292	1292	1292	1292	1292	1292	1292	1292	1292	1292	1292
WOCB3033	1355	1355	1355	1355	1355	1355	1355	1355	1355	1355	1355	1355
WOCB3633	1424	1424	1424	1424	1424	1424	1424	1424	1424	1424	1424	1424
WOCB2436	1373	1373	1373	1373	1373	1373	1373	1373	1373	1373	1373	1373
WOCB3036	1441	1441	1441	1441	1441	1441	1441	1441	1441	1441	1441	1441
WOCB3636	1512	1512	1512	1512	1512	1512	1512	1512	1512	1512	1512	1512
WOCB2439	1392	1392	1392	1392	1392	1392	1392	1392	1392	1392	1392	1392
WOCB3039	1461	1461	1461	1461	1461	1461	1461	1461	1461	1461	1461	1461
WOCB3639	1534	1534	1534	1534	1534	1534	1534	1534	1534	1534	1534	1534
WOCB2442	1392	1392	1392	1392	1392	1392	1392	1392	1392	1392	1392	1392
WOCB3042	1461	1461	1461	1461	1461	1461	1461	1461	1461	1461	1461	1461
WOCB3642	1534	1534	1534	1534	1534	1534	1534	1534	1534	1534	1534	1534

**Custom Modifications**

ADDTK	AUTHL AUTHR	CBO	CCO	CFNTO	CFRMO	CND	EXBKL EXBKR	EXL EXR	FB	FFDL FFDR	FPEB	ID	INVRM	MIP	P	PFINBTMB	RD	TD	TVRAV TVRFV TVRVV	WLI
•	•	STD			•		•	•			•	•		STD	•	•	•		•	

**Construction Upgrades**

APC	PE

**Door Options**

ALF	CG	CG.BTM	CG.TOP	DPSRR	MD	MD.BTM	MD.TOP	MFO

**WALL CHINA DISPLAY, 15" HIGH**

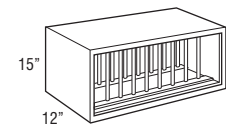

Model	# of Plates
WCD2415	10
WCD3015	13
WCD3615	16

Model	1	2	3	4	5	6
WCD2415	1228	1228	1228	1228	1228	1228
WCD3015	1324	1324	1324	1324	1324	1324
WCD3615	1416	1416	1416	1416	1416	1416

- Matching Interior Plywood (MIP) standard.
- Vertical dowels are 3/8" diameter, 1 1/2" apart.
- Individual dowels are not removable. Complete rack assembly is removable.
- If ordered with Heirloom Technique, will not feature sand-through characteristics.

Model	7	8	9	10	11	12	13	14	15	16	17	18
WCD2415	1228	1228	1228	1228	1228	1228	1228	1228	1228	1228	1228	1228
WCD3015	1324	1324	1324	1324	1324	1324	1324	1324	1324	1324	1324	1324
WCD3615	1416	1416	1416	1416	1416	1416	1416	1416	1416	1416	1416	1416

**Custom Modifications**

ADDTK	AUTHL AUTHR	CBO	CCO	CFNTO	CFRMO	CND	EXBKL EXBKR	EXL EXR	FB	FFDL	FPEB	ID	INVRM	MIP	P	PFINBTMB	RD	TD	TVRAV TVRFV TVRVV	WLI
•		STD			•		•	•			•			STD		•				

**Construction Upgrades**

APC	PE

**Door Options**

ALF	CG	CG.BTM	CG.TOP	DPSRR	MD	MD.BTM	MD.TOP	MFO

WCD2430	1686	1699	1733	1801	1816	1853	2051	1971	2051	2040	2126	2210
WCD3030	1812	1830	1860	1939	1956	1995	2204	2116	2204	2189	2280	2373
WCD3630	1941	1956	1995	2076	2092	2134	2360	2265	2360	2345	2440	2538

WCD2433	1821	1833	1868	1943	1959	2000	2192	2105	2192	2176	2266	2357
WCD3033	1957	1970	2007	2088	2105	2148	2357	2262	2357	2335	2434	2531
WCD3633	2096	2106	2148	2235	2255	2300	2523	2421	2523	2501	2606	2709

WCD2436	1956	1963	2004	2083	2100	2144	2334	2242	2334	2310	2408	2503
WCD3036	2099	2108	2151	2236	2257	2301	2510	2410	2510	2482	2587	2690
WCD3636	2251	2258	2302	2394	2416	2465	2685	2579	2685	2656	2767	2877

WCD2439AH	2152	2159	2205	2292	2311	2359	2567	2466	2567	2540	2646	2753
WCD3039AH	2310	2318	2366	2463	2482	2530	2762	2648	2762	2731	2845	2961
WCD3639AH	2476	2483	2531	2636	2657	2711	2955	2836	2955	2921	3044	3166

WCD2442AH	2223	2226	2269	2359	2382	2427	2617	2512	2617	2581	2687	2794
WCD3042AH	2390	2389	2437	2536	2558	2609	2813	2699	2813	2774	2890	3005
WCD3642AH	2558	2558	2609	2714	2735	2791	3014	2895	3014	2968	3091	3216

**Custom Modifications**

ADDTK	AUTHL AUTHR	CBO	CCO	CFNTO	CFRMO	CND	EXBKL EXBKR	EXL EXR	FB	FFDL	FPEB	ID	INVRM	MIP	P	PFINBTMB	RD	TD	TVRAV TVRFV TVRVV	WLI
•	•	•	•*	•	•		•	•			•			STD		•				

\*Available only on 39" and 42" high

**Construction Upgrades**

APC	PE

**Door Options**

ALF	CG	CG.BTM	CG.TOP	DPSRR	MD	MD.BTM	MD.TOP	MFO
	•			•				•

**WALL CHINA DISPLAY with DOORS, 30", 33", 36", 39", or 42" HIGH**

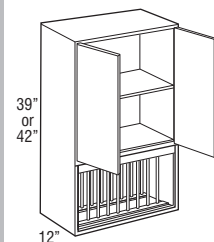
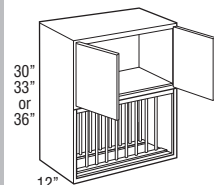

Model	# of Plates
WCD2430	10
WCD3030	13
WCD3630	16
WCD2433	10
WCD3033	13
WCD3633	16
WCD2436	10
WCD3036	13
WCD3636	16
WCD2439AH	10
WCD3039AH	13
WCD3639AH	16
WCD2442AH	10
WCD3042AH	13
WCD3642AH	16

WCD2430	1437	1459	1488	1534	1559	1602
WCD3030	1546	1568	1597	1649	1676	1725
WCD3630	1652	1681	1708	1765	1794	1845

WCD2433	1558	1582	1607	1656	1681	1728
WCD3033	1676	1700	1727	1780	1806	1856
WCD3633	1795	1819	1849	1906	1933	1987

WCD2436	1681	1704	1731	1780	1800	1852
WCD3036	1804	1833	1856	1909	1938	1987
WCD3636	1935	1958	1989	2046	2074	2131

WCD2439AH	1849	1874	1902	1956	1981	2037
WCD3039AH	1984	2014	2042	2099	2130	2185
WCD3639AH	2128	2154	2188	2251	2278	2345

WCD2442AH	1925	1948	1973	2023	2046	2098
WCD3042AH	2065	2093	2119	2175	2199	2256
WCD3642AH	2211	2243	2267	2326	2354	2414

- Matching Interior Plywood (MIP) standard.
- Vertical dowels are 3/8" diameter, 1 1/2" apart.
- Individual dowels are not removable. Complete rack assembly is removable.
- China display section has 12" frame opening height.

**WALL WINE RACK, 15", 18", or 30" HIGH**

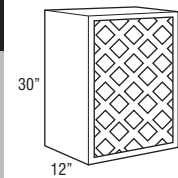
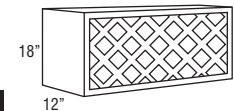
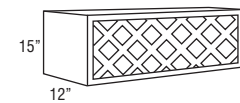

Model	# of Bottles
WNR3015	11
WNR3315	13
WNR3615	13
WNR3018	11
WNR3318	13
WNR3618	13
WNR1530	11
WNR1830	11
WNR2130	11

Model	1	2	3	4	5	6
WNR3015	1027	1027	1027	1027	1027	1027
WNR3315	1069	1069	1069	1069	1069	1069
WNR3615	1123	1123	1123	1123	1123	1123
WNR3018	1059	1059	1059	1059	1059	1059
WNR3318	1101	1101	1101	1101	1101	1101
WNR3618	1144	1144	1144	1144	1144	1144
WNR1530	1007	1007	1007	1007	1007	1007
WNR1830	1059	1059	1059	1059	1059	1059
WNR2130	1123	1123	1123	1123	1123	1123

- Matching Interior Plywood (MIP) standard.
- Cabinet interior finished to match cabinet face frame.
- Solid-wood lattice work.
- Wine bottle opening 4" x 4".
- If ordered with Heirlooming Technique, will not feature sand-through characteristics.

Model	7	8	9	10	11	12	13	14	15	16	17	18
WNR3015	1027	1027	1027	1027	1027	1027	1027	1027	1027	1027	1027	1027
WNR3315	1069	1069	1069	1069	1069	1069	1069	1069	1069	1069	1069	1069
WNR3615	1123	1123	1123	1123	1123	1123	1123	1123	1123	1123	1123	1123
WNR3018	1059	1059	1059	1059	1059	1059	1059	1059	1059	1059	1059	1059
WNR3318	1101	1101	1101	1101	1101	1101	1101	1101	1101	1101	1101	1101
WNR3618	1144	1144	1144	1144	1144	1144	1144	1144	1144	1144	1144	1144
WNR1530	1007	1007	1007	1007	1007	1007	1007	1007	1007	1007	1007	1007
WNR1830	1059	1059	1059	1059	1059	1059	1059	1059	1059	1059	1059	1059
WNR2130	1123	1123	1123	1123	1123	1123	1123	1123	1123	1123	1123	1123

**Custom Modifications**

ADDTK	AUTHL AUTHR	CBO	CCO	CFNTO	CFRMO	CND	EXBKL EXBKR	EXL EXR	FB	FFDL	FFDR	FPEB	ID	INVFRM	MIP	P	PFINBTMB	RD	TD	TVRAV TVRFV TVRVV	WLI
•		STD			•		•	•				•			STD		•				

**Construction Upgrades**

APC	PE

**Door Options**

ALF	CG	CG.BTM	CG.TOP	DPSRR	MD	MD.BTM	MD.TOP	MFO

**WINE STORAGE CABINET, 12", 15", 18", 21", or 24" HIGH**

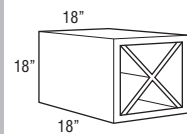
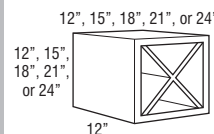

Model	# of Bottles
WSC121212	4
WSC151512	10
WSC181812	18
WSC212112	24
WSC242412	32
WSC181818	18

Model	1	2	3	4	5	6
WSC121212	618	618	618	618	618	618
WSC151512	652	652	652	652	652	652
WSC181812	686	686	686	686	686	686
WSC212112	720	720	720	720	720	720
WSC242412	756	756	756	756	756	756
WSC181818	745	745	745	745	745	745

- Matching Interior Plywood (MIP) standard.
- Must be installed between two cabinets, between a cabinet and a wall, or mounted to a horizontal surface.
- "X" shelf configuration cannot be removed.
- If ordered with Heirlooming Technique, will not feature sand-through characteristics.
- Reduced depth not recommended for safe wine bottle storage.

Model	7	8	9	10	11	12	13	14	15	16	17	18
WSC121212	618	618	618	618	618	618	618	618	618	618	618	618
WSC151512	652	652	652	652	652	652	652	652	652	652	652	652
WSC181812	686	686	686	686	686	686	686	686	686	686	686	686
WSC212112	720	720	720	720	720	720	720	720	720	720	720	720
WSC242412	756	756	756	756	756	756	756	756	756	756	756	756
WSC181818	745	745	745	745	745	745	745	745	745	745	745	745

**Custom Modifications**

ADDTK	AUTHL AUTHR	CBO	CCO	CFNTO	CFRMO	CND	EXBKL EXBKR	EXL EXR	FB	FFDL	FFDR	FPEB	ID	INVFRM	MIP	P	PFINBTMB	RD	TD	TVRAV TVRFV TVRVV	WLI
							•					•	•*		STD		•	•			

\*ID on 12" deep models available up to 18" deep

**Construction Upgrades**

APC	PE

**Door Options**

ALF	CG	CG.BTM	CG.TOP	DPSRR	MD	MD.BTM	MD.TOP	MFO

**WALL WINE CUBBY, 24", 30", 36", or 42" WIDE, 6" HIGH**

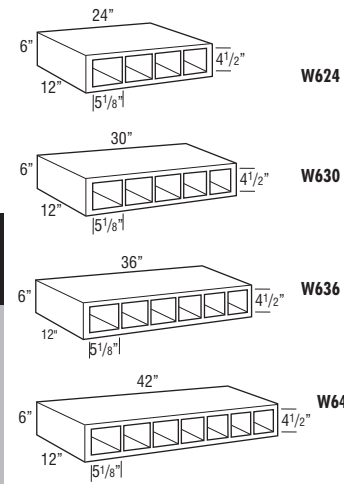

Model	1	2	3	4	5	6
<b>W624</b> (4 openings)	864	864	864	864	864	864
<b>W630</b> (5 openings)	908	908	908	908	908	908
<b>W636</b> (6 openings)	996	996	996	996	996	996
<b>W642</b> (7 openings)	1097	1097	1097	1097	1097	1097

- Veneer on 3/4" furniture board core.
- Matching interior.
- Frameless construction.
- If ordered with Heirlooming Technique, will not feature sand-through characteristics.
- Increased Depth only available in 3" increments.

**WALL ORGANIZER, 24", 30", or 36" WIDE, 6" HIGH**

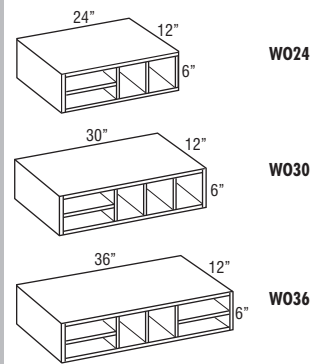

Model	1	2	3	4	5	6
<b>WO24</b>	864	864	864	864	864	864
<b>WO30</b>	908	908	908	908	908	908
<b>WO36</b>	996	996	996	996	996	996

- Veneer on a 3/4" furniture board core.
- Frameless construction.
- Matching interior.
- If ordered with Heirlooming Technique, will not feature sand-through characteristics.
- Increased Depth only available in 3" increments.

**WALL SPICE DRAWER, 24", 30", 36", or 42" WIDE, 6" HIGH**

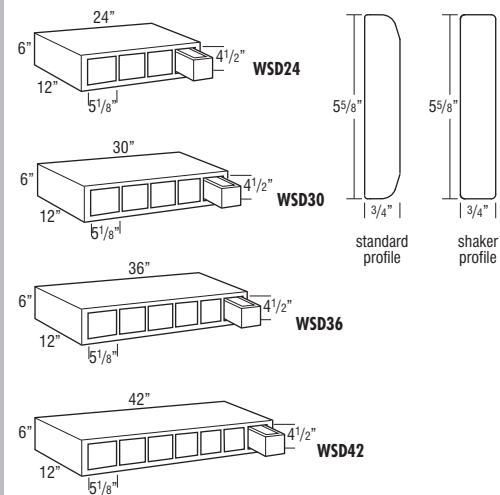

Model	1	2	3	4	5	6
<b>WSD24</b> (4 drawers)	974	974	974	974	974	974
<b>WSD30</b> (5 drawers)	1039	1039	1039	1039	1039	1039
<b>WSD36</b> (6 drawers)	1136	1136	1136	1136	1136	1136
<b>WSD42</b> (7 drawers)	1364	1364	1364	1364	1364	1364

- Drawer front is unique to item and will not match profile chosen.
- All styles use standard drawer front profile except Ainsley, Brantley, Campbell, Denton, Elston, Huxley, Kennedy, Lainey, Natcher, Pleasant Hill, Prestley, Rivali, Seaton, and Whittaker, which use the shaker profile.
- Aspen, Derazi, Gallo, and Hera drawer fronts will match doors and drawer fronts.
- Veneer on 3/4" furniture board core.
- 1/2" hardwood drawer with rabbet joint.
- Horizontal application only.
- Matching interior.
- Frameless construction.
- Increased Depth only available in 3" increments.

Model	7	8	9	10	11	12	13	14	15	16	17	18
<b>W624</b> (4 openings)	864	864	864	864	864	864	864	864	864	864	864	864
<b>W630</b> (5 openings)	908	908	908	908	908	908	908	908	908	908	908	908
<b>W636</b> (6 openings)	996	996	996	996	996	996	996	996	996	996	996	996
<b>W642</b> (7 openings)	1097	1097	1097	1097	1097	1097	1097	1097	1097	1097	1097	1097

**Custom Modifications**

ADDTK	AUTHL AUTHR	CBO	CCO	CFNTD	CFRMO	CND	EXBKL EXBKR	EXL EXR	FB	FFDL FFDR	FPEB	ID	INVFRM	MIP	P	PFINBTMB	RD	TD	TVRAV TVRFV TVRVV	WLI
									STD											

**Construction Upgrades**

APC	PE

**Door Options**

ALF	CG	CG.BTM	CG.TOP	DPSRR	MD	MD.BTM	MD.TOP	MFO

Model	1	2	3	4	5	6	7	8	9	10	11	12	13	14	15	16	17	18
<b>WO24</b>	864	864	864	864	864	864	864	864	864	864	864	864	864	864	864	864	864	864
<b>WO30</b>	908	908	908	908	908	908	908	908	908	908	908	908	908	908	908	908	908	908
<b>WO36</b>	996	996	996	996	996	996	996	996	996	996	996	996	996	996	996	996	996	996

**Custom Modifications**

ADDTK	AUTHL AUTHR	CBO	CCO	CFNTD	CFRMO	CND	EXBKL EXBKR	EXL EXR	FB	FFDL FFDR	FPEB	ID	INVFRM	MIP	P	PFINBTMB	RD	TD	TVRAV TVRFV TVRVV	WLI
									STD											

**Construction Upgrades**

APC	PE

**Door Options**

ALF	CG	CG.BTM	CG.TOP	DPSRR	MD	MD.BTM	MD.TOP	MFO

Model	1	2	3	4	5	6	7	8	9	10	11	12	13	14	15	16	17	18
<b>WSD24</b> (4 drawers)	974	974	974	974	974	974	974	974	974	974	974	974	974	974	974	974	974	974
<b>WSD30</b> (5 drawers)	1039	1039	1039	1039	1039	1039	1039	1039	1039	1039	1039	1039	1039	1039	1039	1039	1039	1039
<b>WSD36</b> (6 drawers)	1136	1136	1136	1136	1136	1136	1136	1136	1136	1136	1136	1136	1136	1136	1136	1136	1136	1136
<b>WSD42</b> (7 drawers)	1364	1364	1364	1364	1364	1364	1364	1364	1364	1364	1364	1364	1364	1364	1364	1364	1364	1364

**Custom Modifications**

ADDTK	AUTHL AUTHR	CBO	CCO	CFNTD	CFRMO	CND	EXBKL EXBKR	EXL EXR	FB	FFDL FFDR	FPEB	ID	INVFRM	MIP	P	PFINBTMB	RD	TD	TVRAV TVRFV TVRVV	WLI
									STD											

**Construction Upgrades**

APC	PE

**Door Options**

ALF	CG	CG.BTM	CG.TOP	DPSRR	MD	MD.BTM	MD.TOP	MFO

**WALL MESSAGE CENTER, 30", 33", 36", 39", or 42" HIGH, 3" DEEP**

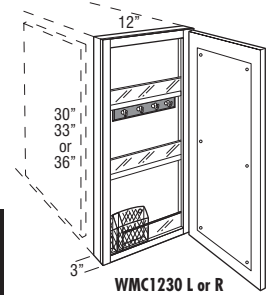

WMC1230 L or R  
WMC1233 L or R  
WMC1236 L or R

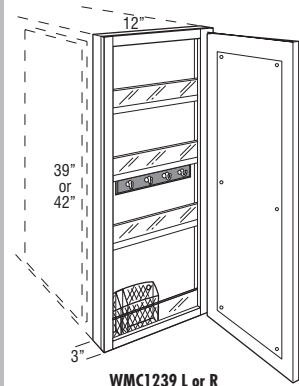

WMC1239 L or R  
WMC1242 L or R

Model	1	2	3	4	5	6
WMC1230 L or R	868	889	933	981	1021	1046
WMC1233 L or R	910	934	985	1038	1082	1107
WMC1236 L or R	951	979	1035	1093	1140	1168
WMC1239 L or R	993	1023	1084	1149	1201	1231
WMC1242 L or R	1036	1069	1135	1202	1263	1300

- Includes magnetic whiteboard on back of door, key hooks, pencil holder, and fixed plexi-glass fronted shelves.
- WMC1230, WMC1233 L or R, and WMC1236 have 2 fixed shelves. WMC1239 and WMC1242 have 3 fixed shelves.
- Not recommended for use next to a Peninsula cabinet due to the additional 1/4" cabinet depth.
- Door will open 90° without decorative hardware.
- Cabinet should be hinged on wall side.
- For proper installation, adjacent cabinet must have FPEB or 1/4" skin applied.
- Embellishments or overlay fillers can be used on side of cabinet to add a decorative touch.

**CLASSIC ARCH WOOD HOOD, 36", 42", or 48" WIDE, 24 7/8" HIGH**

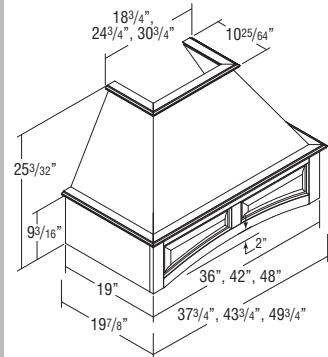

WHA36	4169	4169	4169	4169	4169	4169
WHA42	4466	4466	4466	4466	4466	4466
WHA48	4691	4691	4691	4691	4691	4691

- Freestanding unit (must be properly secured to wall and cannot be attached to adjacent cabinets).
- Exhaust system not included. Compatible with all Schrock blowers.
- Compatible with Classic Wood Hood Chimney (WHC\_ ), which can be trimmed. See page 206.
- Check your local building code for installation heights above the range.
- Silver metallic liner included. Assembly required.
- Arched raised panel valance front.
- Installation instructions and hardware included.
- Liner opening size: 10 1/4" deep by 19 1/2" wide.
- Wood hoods ordered in Rustic Alder and Rustic Hickory will not feature Rustic characteristics.

**CLASSIC SQUARE WOOD HOOD, 30", 36", 42", or 48" WIDE, 22 7/8" HIGH**

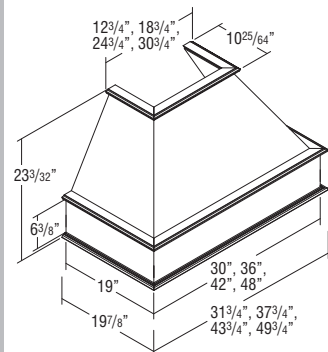

WHS30	3586	3586	3586	3586	3586	3586
WHS36	3775	3775	3775	3775	3775	3775
WHS42	3897	3897	3897	3897	3897	3897
WHS48	4078	4078	4078	4078	4078	4078

- Wood hoods are designed for use with decorative overlays.
- Freestanding unit (must be properly secured to wall and cannot be attached to adjacent cabinets).
- Exhaust system not included. Compatible with all Schrock blowers.
- Compatible with Classic Wood Hood Chimney (WHC\_ ), which can be trimmed. See page 206.
- Check your local building code for installation heights above the range.
- Silver metallic liner included. Assembly required.
- Installation instructions and hardware included.
- Liner opening size: 10 1/4" deep by 19 1/2" wide.
- Wood hoods ordered in Rustic Alder and Rustic Hickory will not feature Rustic characteristics.

Model	7	8	9	10	11	12	13	14	15	16	17	18
WMC1230 L or R	1026	1077	1088	1108	1112	1099	1150	1153	1179	1212	1239	1267
WMC1233 L or R	1087	1141	1155	1176	1182	1183	1222	1226	1256	1284	1314	1346
WMC1236 L or R	1149	1207	1219	1247	1252	1267	1296	1302	1334	1355	1391	1424
WMC1239 L or R	1212	1273	1289	1317	1322	1342	1371	1376	1414	1439	1476	1514
WMC1242 L or R	1269	1347	1364	1397	1404	1421	1457	1462	1501	1528	1568	1609

**Custom Modifications**

ADDTK	AUTHL AUTHR	CBO	CCO	CFNTO	CFRMO	CND	EXBKL EXBKR	EXL EXR	FB	FFDL FFDR	FPEB	ID	INVFRM	MIP	P	PFINBTMB	RD	TD	TVRAV TVRFV TVRVV	WLI	
		•	•								STD			•							•

**Construction Upgrades**

APC	PE
•	

**Door Options**

ALF	CG	CG.BTM	CG.TOP	DPSRR	MD	MD.BTM	MD.TOP	MFO
				•				•

WHA36	4169	4169	4169	4169	4169	4169	4169	4169	4169	4169	4169	4169
WHA42	4466	4466	4466	4466	4466	4466	4466	4466	4466	4466	4466	4466
WHA48	4691	4691	4691	4691	4691	4691	4691	4691	4691	4691	4691	4691

**MODIFICATIONS**

No modifications available for these products.

**Finish Techniques**

Distressing	Heirlooming
•	•

WHS30	3586	3586	3586	3586	3586	3586	3586	3586	3586	3586	3586	3586
WHS36	3775	3775	3775	3775	3775	3775	3775	3775	3775	3775	3775	3775
WHS42	3897	3897	3897	3897	3897	3897	3897	3897	3897	3897	3897	3897
WHS48	4078	4078	4078	4078	4078	4078	4078	4078	4078	4078	4078	4078

**MODIFICATIONS**

No modifications available for these products.

**Finish Techniques**

Distressing	Heirlooming
•	•



**ARCH FLAT PANEL WOOD HOOD, 30", 36", 42", or 48" WIDE**

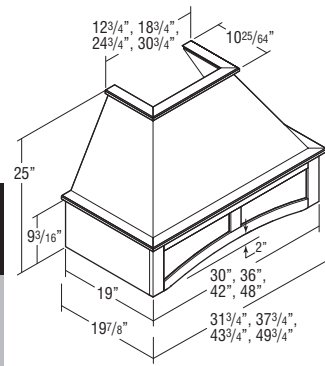

Model	1	2	3	4	5	6
WHAFP30	3921	3921	3921	3921	3921	3921
WHAFP36	3961	3961	3961	3961	3961	3961
WHAFP42	4243	4243	4243	4243	4243	4243
WHAFP48	4456	4456	4456	4456	4456	4456

- Freestanding unit (must be properly secured to wall and cannot be attached to adjacent cabinets).
- Exhaust system not included. Compatible with all Schrock blowers.
- Compatible with Classic Wood Hood Chimney (WHC\_ ), which can be trimmed. See below.
- Check local building code and appliance installation specifications for clearance requirements and installation heights above the range.
- Silver metallic liner included. Assembly required.
- Installation instructions and hardware included.
- Liner opening size: 10 1/4" deep by 19 1/2" wide.
- Wood hoods ordered in Rustic Alder and Rustic Hickory will not feature Rustic characteristics.
- No changes or cancellations will be accepted after 24 hours from acknowledgment of order.

**SQUARE FLAT PANEL WOOD HOOD, 30", 36", 42", or 48" WIDE**

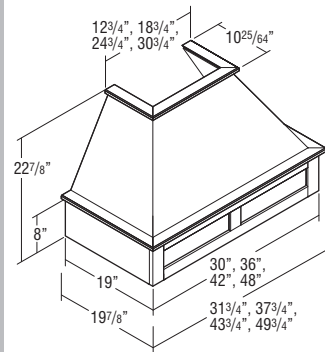

WHSFP30	3737	3737	3737	3737	3737	3737
WHSFP36	3775	3775	3775	3775	3775	3775
WHSFP42	3897	3897	3897	3897	3897	3897
WHSFP48	4078	4078	4078	4078	4078	4078

- Freestanding unit (must be properly secured to wall and cannot be attached to adjacent cabinets).
- Exhaust system not included. Compatible with all Schrock blowers.
- Compatible with Classic Wood Hood Chimney (WHC\_ ), which can be trimmed. See below.
- Check local building code and appliance installation specifications for clearance requirements and installation heights above the range.
- Silver metallic liner included. Assembly required.
- Installation instructions and hardware included.
- Liner opening size: 10 1/4" deep by 19 1/2" wide.
- Wood hoods ordered in Rustic Alder and Rustic Hickory will not feature Rustic characteristics.
- No changes or cancellations will be accepted after 24 hours from acknowledgment of order.

**CLASSIC WOOD HOOD CHIMNEY, 23 1/2" HIGH**

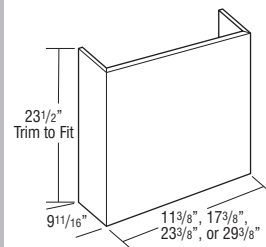

Model	1	2	3	4	5	6
WHC30	711	711	711	711	711	711
WHC36	711	711	711	711	711	711
WHC42	831	831	831	831	831	831
WHC48	905	905	905	905	905	905

- 3/4" thick plywood.
- Trimable.
- If trimmed, moulding is recommended to conceal any cut marks.
- Optional accessory for Classic Arch Wood Hood (WHA), Classic Square Wood Hood (WHS), Arch Flat Panel Wood Hood (WHAFP), and Square Flat Panel Wood Hood (WHSFP).
- Wood hoods ordered in Rustic Alder and Rustic Hickory will not feature Rustic characteristics.

**LINEAR TAPERED WOOD HOOD, 30", 36", or 42" WIDE**

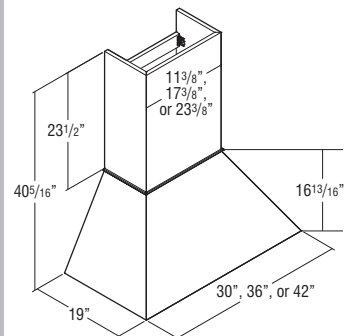

JWHL30	3660	3660	3660	3660	3660	3660
JWHL36	3897	3897	3897	3897	3897	3897
JWHL42	4078	4078	4078	4078	4078	4078

- Freestanding unit (must be properly secured to wall and cannot be attached to adjacent cabinets).
- Exhaust system not included. Compatible with all Schrock blowers.
- Chimney included and can be trimmed.
- Check your local building code for installation heights above the range.
- Silver metallic liner included. Assembly required.
- Installation instructions and hardware included.
- Liner opening size: 10 1/4" deep by 19 1/2" wide.
- Wood hoods ordered in Rustic Alder and Rustic Hickory will not feature Rustic characteristics.
- Available in glaze finishes, but wood hood design does not provide detail for glaze hang-up.
- No changes or cancellations will be accepted after 24 hours from acknowledgment of order.

Model	7	8	9	10	11	12	13	14	15	16	17	18
WHAFP30	3921	3921	3921	3921	3921	3921	3921	3921	3921	3921	3921	3921
WHAFP36	3961	3961	3961	3961	3961	3961	3961	3961	3961	3961	3961	3961
WHAFP42	4243	4243	4243	4243	4243	4243	4243	4243	4243	4243	4243	4243
WHAFP48	4456	4456	4456	4456	4456	4456	4456	4456	4456	4456	4456	4456

**MODIFICATIONS**

No modifications available for these products.

**Finish Techniques**

Distressing	Heirlooming
•	•

WHSFP30	3737	3737	3737	3737	3737	3737	3737	3737	3737	3737	3737	3737
WHSFP36	3775	3775	3775	3775	3775	3775	3775	3775	3775	3775	3775	3775
WHSFP42	3897	3897	3897	3897	3897	3897	3897	3897	3897	3897	3897	3897
WHSFP48	4078	4078	4078	4078	4078	4078	4078	4078	4078	4078	4078	4078

**MODIFICATIONS**

No modifications available for these products.

**Finish Techniques**

Distressing	Heirlooming
•	•

WHC30	711	711	711	711	711	711	711	711	711	711	711	711
WHC36	711	711	711	711	711	711	711	711	711	711	711	711
WHC42	831	831	831	831	831	831	831	831	831	831	831	831
WHC48	905	905	905	905	905	905	905	905	905	905	905	905

**MODIFICATIONS**

No modifications available for these products.

**Finish Techniques**

Distressing	Heirlooming
•	•

JWHL30	3660	3660	3660	3660	3660	3660	3660	3660	3660	3660	3660	3660
JWHL36	3897	3897	3897	3897	3897	3897	3897	3897	3897	3897	3897	3897
JWHL42	4078	4078	4078	4078	4078	4078	4078	4078	4078	4078	4078	4078

**MODIFICATIONS**

No modifications available for these products.

**SHIPLAP STRAIGHT WOOD HOOD,  
36", 42", or 48" WIDE**

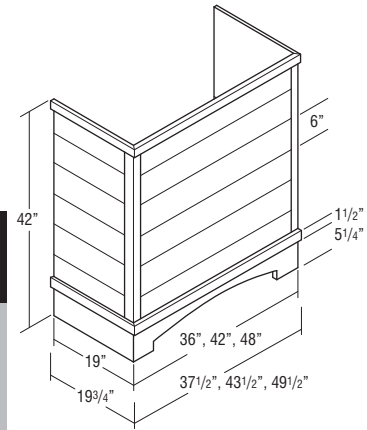

**SHIPLAP STRAIGHT WOOD HOOD  
with CORBELS, 36", 42", or 48" WIDE**

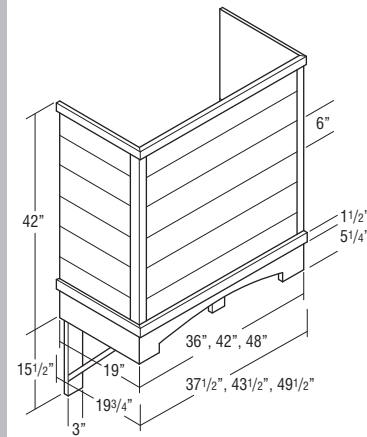

Model	1	2	3	4	5	6
<b>JWHSHPSTR36</b>	4337	4337	4337	4337	4337	4337
<b>JWHSHPSTR42</b>	4459	4459	4459	4459	4459	4459
<b>JWHSHPSTR48</b>	4640	4640	4640	4640	4640	4640

- Freestanding unit (must be properly secured to wall and cannot be attached to adjacent cabinets).
- Constructed of 3/4" thick grooved plywood creating a shiplap appearance.
- Trimable. If trimmed, moulding is recommended to conceal any cut marks.
- Exhaust system not included. Compatible with all Schrock blowers.
- Check local building code and appliance installation specifications for clearance requirements and installation heights above the range.
- Silver metallic liner included. Assembly required.
- Installation instructions and hardware included.
- Liner opening size: 10 1/4" deep by 19 1/2" wide.
- Wood hoods ordered in Rustic Alder will not feature Rustic characteristics.
- Not available in Rustic Hickory.
- No changes or cancellations will be accepted after 24 hours from acknowledgment of order.

<b>JWHSHPSTRCB36</b>	4643	4643	4643	4643	4643	4643
<b>JWHSHPSTRCB42</b>	4765	4765	4765	4765	4765	4765
<b>JWHSHPSTRCB48</b>	4946	4946	4946	4946	4946	4946

- Includes a pair of decorative corbels.
- Freestanding unit (must be properly secured to wall and cannot be attached to adjacent cabinets).
- Constructed of 3/4" thick grooved plywood creating a shiplap appearance.
- Trimable. If trimmed, moulding is recommended to conceal any cut marks.
- Exhaust system not included. Compatible with all Schrock blowers.
- Check local building code and appliance installation specifications for clearance requirements (including corbels) and installation heights above the range.
- Silver metallic liner included. Assembly required.
- Installation instructions and hardware included.
- Liner opening size: 10 1/4" deep by 19 1/2" wide.
- Wood hoods ordered in Rustic Alder will not feature Rustic characteristics.
- Not available in Rustic Hickory.
- No changes or cancellations will be accepted after 24 hours from acknowledgment of order.

Model	7	8	9	10	11	12	13	14	15	16	17	18
<b>JWHSHPSTR36</b>	4337	4337	4337	4337	4337	4337	4337	4337	4337	4337	4337	4337
<b>JWHSHPSTR42</b>	4459	4459	4459	4459	4459	4459	4459	4459	4459	4459	4459	4459
<b>JWHSHPSTR48</b>	4640	4640	4640	4640	4640	4640	4640	4640	4640	4640	4640	4640

**MODIFICATIONS**

No modifications available for these products.

**Finish Techniques**

Distressing	Heirlooming
•	•

<b>JWHSHPSTRCB36</b>	4643	4643	4643	4643	4643	4643	4643	4643	4643	4643	4643	4643
<b>JWHSHPSTRCB42</b>	4765	4765	4765	4765	4765	4765	4765	4765	4765	4765	4765	4765
<b>JWHSHPSTRCB48</b>	4946	4946	4946	4946	4946	4946	4946	4946	4946	4946	4946	4946

**MODIFICATIONS**

No modifications available for these products.

**Finish Techniques**

Distressing	Heirlooming
•	•

**SHIPLAP TAPERED WOOD HOOD, 30", 36", 42", or 48" WIDE**

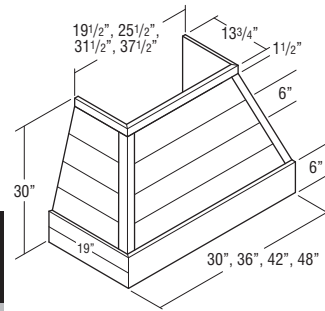

Model	1	2	3	4	5	6
<b>JWHSIPT30</b>	4169	4169	4169	4169	4169	4169
<b>JWHSIPT36</b>	4731	4731	4731	4731	4731	4731
<b>JWHSIPT42</b>	5028	5028	5028	5028	5028	5028
<b>JWHSIPT48</b>	5253	5253	5253	5253	5253	5253

- Freestanding unit (must be properly secured to wall and cannot be attached to adjacent cabinets).
- Constructed of 3/4" thick grooved plywood creating a shiplap appearance.
- Exhaust system not included. Compatible with all Schrock blowers.
- Compatible with Shiplap Wood Hood Chimney (JWHSIPCH\_\_), which can be trimmed. See below.
- Check local building code and appliance installation specifications for clearance requirements and installation heights above the range.
- Silver metallic liner included. Assembly required.
- Installation instructions and hardware included.
- Liner opening size: 10 1/4" deep by 19 1/2" wide.
- Wood hoods ordered in Rustic Alder will not feature Rustic characteristics.
- Not available in Rustic Hickory.
- No changes or cancellations will be accepted after 24 hours from acknowledgment of order.

**SHIPLAP TAPERED WOOD HOOD with CORBELS, 36", 42", or 48" WIDE**

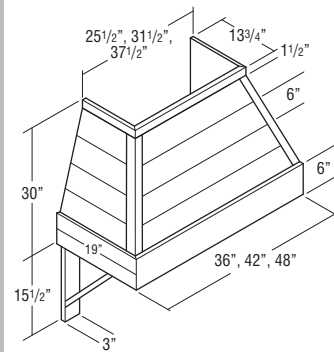

<b>JWHSIPTCB36</b>	5037	5037	5037	5037	5037	5037
<b>JWHSIPTCB42</b>	5334	5334	5334	5334	5334	5334
<b>JWHSIPTCB48</b>	5559	5559	5559	5559	5559	5559

- Includes a pair of decorative corbels.
- Freestanding unit (must be properly secured to wall and cannot be attached to adjacent cabinets).
- Constructed of 3/4" thick grooved plywood creating a shiplap appearance.
- Exhaust system not included. Compatible with all Schrock blowers.
- Compatible with Shiplap Wood Hood Chimney (JWHSIPCH\_\_), which can be trimmed. See below.
- Check local building code and appliance installation specifications for clearance requirements (including corbels) and installation heights above the range.
- Silver metallic liner included. Assembly required.
- Installation instructions and hardware included.
- Liner opening size: 10 1/4" deep by 19 1/2" wide.
- Wood hoods ordered in Rustic Alder will not feature Rustic characteristics.
- Not available in Rustic Hickory.
- No changes or cancellations will be accepted after 24 hours from acknowledgment of order.

**SHIPLAP WOOD HOOD CHIMNEY, 24 3/4" HIGH**

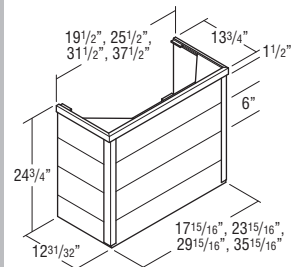

<b>JWHSIPCH30</b>	1273	1273	1273	1273	1273	1273
<b>JWHSIPCH36</b>	1273	1273	1273	1273	1273	1273
<b>JWHSIPCH42</b>	1393	1393	1393	1393	1393	1393
<b>JWHSIPCH48</b>	1467	1467	1467	1467	1467	1467

- Constructed of 3/4" thick grooved plywood creating a shiplap appearance.
- Trimtable. If trimmed, moulding is recommended to conceal any cut marks.
- Optional accessory for Shiplap Tapered Wood Hoods (JWHSIPT\_\_ and JWHSIPTCB\_\_) for an installed height of 54".
- Wood hoods ordered in Rustic Alder will not feature Rustic characteristics.
- Not available in Rustic Hickory.
- No changes or cancellations will be accepted after 24 hours from acknowledgment of order.

Model	7	8	9	10	11	12	13	14	15	16	17	18
<b>JWHSIPT30</b>	4169	4169	4169	4169	4169	4169	4169	4169	4169	4169	4169	4169
<b>JWHSIPT36</b>	4731	4731	4731	4731	4731	4731	4731	4731	4731	4731	4731	4731
<b>JWHSIPT42</b>	5028	5028	5028	5028	5028	5028	5028	5028	5028	5028	5028	5028
<b>JWHSIPT48</b>	5253	5253	5253	5253	5253	5253	5253	5253	5253	5253	5253	5253

**MODIFICATIONS**

No modifications available for these products.

**Finish Techniques**

Distressing	Heirlooming
•	•

<b>JWHSIPTCB36</b>	5037	5037	5037	5037	5037	5037	5037	5037	5037	5037	5037	5037
<b>JWHSIPTCB42</b>	5334	5334	5334	5334	5334	5334	5334	5334	5334	5334	5334	5334
<b>JWHSIPTCB48</b>	5559	5559	5559	5559	5559	5559	5559	5559	5559	5559	5559	5559

**MODIFICATIONS**

No modifications available for these products.

**Finish Techniques**

Distressing	Heirlooming
•	•

<b>JWHSIPCH30</b>	1273	1273	1273	1273	1273	1273	1273	1273	1273	1273	1273	1273
<b>JWHSIPCH36</b>	1273	1273	1273	1273	1273	1273	1273	1273	1273	1273	1273	1273
<b>JWHSIPCH42</b>	1393	1393	1393	1393	1393	1393	1393	1393	1393	1393	1393	1393
<b>JWHSIPCH48</b>	1467	1467	1467	1467	1467	1467	1467	1467	1467	1467	1467	1467

**MODIFICATIONS**

No modifications available for these products.

**Finish Techniques**

Distressing	Heirlooming
•	•

**NEW** SIMPLE TAPERED WOOD HOOD,  
30", 36", 42", or 48" WIDE

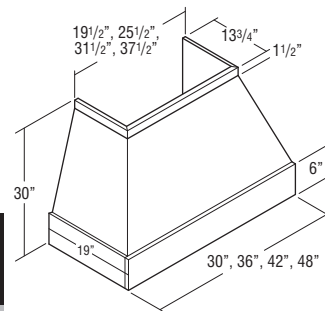

Model	1	2	3	4	5	6
WHSMT30	4169	4169	4169	4169	4169	4169
WHSMT36	4731	4731	4731	4731	4731	4731
WHSMT42	5028	5028	5028	5028	5028	5028
WHSMT48	5253	5253	5253	5253	5253	5253

- Freestanding unit (must be properly secured to wall and cannot be attached to adjacent cabinets).
- Exhaust system not included. Compatible with all Schrock blowers.
- Compatible with Simple Wood Hood Chimney (WHSMC\_ ), which can be trimmed. See below.
- Check local building code and appliance installation specifications for clearance requirements and installation heights above the range.
- Silver metallic liner included. Assembly required.
- Installation instructions and hardware included.
- Liner opening size: 10 1/4" deep by 19 1/2" wide.
- Wood hoods ordered in Rustic Alder will not feature Rustic characteristics.
- Not available in Rustic Hickory.
- No changes or cancellations will be accepted after 24 hours from acknowledgment of order.

**NEW** SIMPLE TAPERED WOOD HOOD  
with CORBELS, 36", 42", or  
48" WIDE

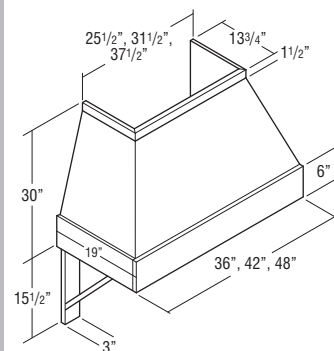

WHSMTCB36	5037	5037	5037	5037	5037	5037
WHSMTCB42	5334	5334	5334	5334	5334	5334
WHSMTCB48	5559	5559	5559	5559	5559	5559

- Includes a pair of decorative corbels.
- Freestanding unit (must be properly secured to wall and cannot be attached to adjacent cabinets).
- Exhaust system not included. Compatible with all Schrock blowers.
- Compatible with Simple Wood Hood Chimney (WHSMC\_ ), which can be trimmed. See below.
- Check local building code and appliance installation specifications for clearance requirements (including corbels) and installation heights above the range.
- Silver metallic liner included. Assembly required.
- Installation instructions and hardware included.
- Liner opening size: 10 1/4" deep by 19 1/2" wide.
- Wood hoods ordered in Rustic Alder will not feature Rustic characteristics.
- Not available in Rustic Hickory.
- No changes or cancellations will be accepted after 24 hours from acknowledgment of order.

**NEW** SIMPLE WOOD HOOD  
CHIMNEY, 24 3/4" HIGH

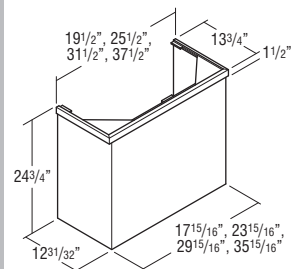

WHSMC30	1273	1273	1273	1273	1273	1273
WHSMC36	1273	1273	1273	1273	1273	1273
WHSMC42	1393	1393	1393	1393	1393	1393
WHSMC48	1467	1467	1467	1467	1467	1467

- Trimtable. If trimmed, moulding is recommended to conceal any cut marks.
- Optional accessory for Simple Tapered Wood Hoods (WHSMT\_ and WHSMTCB\_ ) for an installed height of 54".
- Wood hoods ordered in Rustic Alder will not feature Rustic characteristics.
- Not available in Rustic Hickory.
- No changes or cancellations will be accepted after 24 hours from acknowledgment of order.

Model	7	8	9	10	11	12	13	14	15	16	17	18
WHSMT30	4169	4169	4169	4169	4169	4169	4169	4169	4169	4169	4169	4169
WHSMT36	4731	4731	4731	4731	4731	4731	4731	4731	4731	4731	4731	4731
WHSMT42	5028	5028	5028	5028	5028	5028	5028	5028	5028	5028	5028	5028
WHSMT48	5253	5253	5253	5253	5253	5253	5253	5253	5253	5253	5253	5253

MODIFICATIONS
No modifications available for these products.

Finish Techniques

Distressing	Heirlooming
•	•

WHSMTCB36	5037	5037	5037	5037	5037	5037	5037	5037	5037	5037	5037	5037
WHSMTCB42	5334	5334	5334	5334	5334	5334	5334	5334	5334	5334	5334	5334
WHSMTCB48	5559	5559	5559	5559	5559	5559	5559	5559	5559	5559	5559	5559

MODIFICATIONS
No modifications available for these products.

Finish Techniques

Distressing	Heirlooming
•	•

WHSMC30	1273	1273	1273	1273	1273	1273	1273	1273	1273	1273	1273	1273
WHSMC36	1273	1273	1273	1273	1273	1273	1273	1273	1273	1273	1273	1273
WHSMC42	1393	1393	1393	1393	1393	1393	1393	1393	1393	1393	1393	1393
WHSMC48	1467	1467	1467	1467	1467	1467	1467	1467	1467	1467	1467	1467

MODIFICATIONS
No modifications available for these products.

Finish Techniques

Distressing	Heirlooming
•	•

**CANOPY ARCH WOOD HOOD, 30" or 36" WIDE, 24" HIGH**

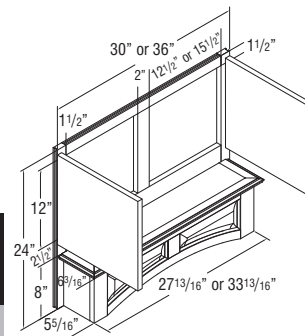

Model	1	2	3	4	5	6
<b>WHCA30</b>	2816	2816	2816	2816	2816	2816
<b>WHCA36</b>	3042	3042	3042	3042	3042	3042

- Install Wood Hoods between adjacent cabinets.
- Doors matching the style ordered will be installed on hood.
- Exhaust system not included. Compatible with all Schrock blowers.
- Check your local building code for installation heights above the range.
- Silver metallic liner included. Assembly required. Interior bottom section is finished below liner. Liner is not arched.
- Installation instructions and hardware included.
- Liner opening size: 10 1/4" deep by 19 1/2" wide.
- When ordered in Rustic Alder or Rustic Hickory, only the doors will have Rustic characteristics.
- Arched raised panel valance front.

**CANOPY ARCH WOOD HOOD, 30" or 36" WIDE, 30" HIGH**

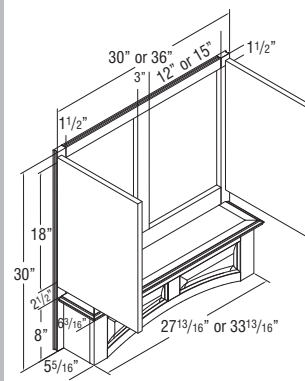

<b>JWHCA3030</b>	3081	3081	3081	3081	3081	3081
<b>JWHCA3630</b>	3332	3332	3332	3332	3332	3332

- Install Wood Hoods between adjacent cabinets.
- Doors matching the style ordered will be installed on hood.
- Exhaust system not included. Compatible with all Schrock blowers.
- Check your local building code for installation heights above the range.
- Silver metallic liner included. Assembly required. Interior bottom section is finished below liner. Liner is not arched.
- Installation instructions and hardware included.
- Liner opening size: 10 1/4" deep by 19 1/2" wide.
- When ordered in Rustic Alder or Rustic Hickory, only the doors will have Rustic characteristics.
- Filter is not required unless using a ductless conversion kit. If ductless conversion kit required, see CONVERSION on page 220.
- Arched raised panel valance front.
- No changes or cancellations will be accepted after 24 hours from acknowledgment of order.

**CANOPY SQUARE WOOD HOOD, 30" or 36" WIDE, 24" HIGH**

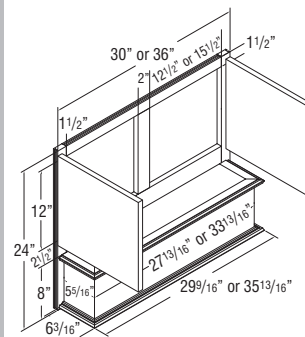

<b>WHCS30</b>	2513	2513	2513	2513	2513	2513
<b>WHCS36</b>	2715	2715	2715	2715	2715	2715

- Install Wood Hoods between adjacent cabinets.
- Doors matching the style ordered will be installed on hood.
- Exhaust system not included. Compatible with all Schrock blowers.
- Check your local building code for installation heights above the range.
- Silver metallic liner included. Assembly required. Interior bottom section is finished below liner.
- Installation instructions and hardware included.
- Liner opening size: 10 1/4" deep by 19 1/2" wide.
- When ordered in Rustic Alder or Rustic Hickory, only the doors will have Rustic characteristics.

**CANOPY SQUARE WOOD HOOD, 30" or 36" WIDE, 30" HIGH**

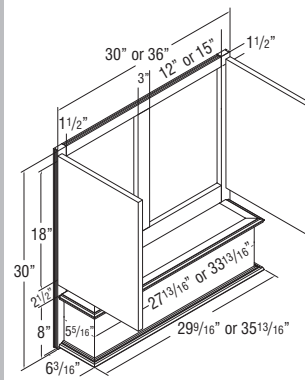

<b>JWHCS3030</b>	2753	2753	2753	2753	2753	2753
<b>JWHCS3630</b>	2972	2972	2972	2972	2972	2972

- Install Wood Hoods between adjacent cabinets.
- Doors matching the style ordered will be installed on hood.
- Exhaust system not included. Compatible with all Schrock blowers.
- Check your local building code for installation heights above the range.
- Silver metallic liner included. Assembly required. Interior bottom section is finished below liner.
- Installation instructions and hardware included.
- Liner opening size: 10 1/4" deep by 19 1/2" wide.
- When ordered in Rustic Alder or Rustic Hickory, only the doors will have Rustic characteristics.
- Filter is not required unless using a ductless conversion kit. If ductless conversion kit required, see CONVERSION on page 220.
- No changes or cancellations will be accepted after 24 hours from acknowledgment of order.

Model	7	8	9	10	11	12	13	14	15	16	17	18
<b>WHCA30</b>	2964	2964	2964	2964	2964	2964	3112	3112	3112	3112	3112	3112
<b>WHCA36</b>	3200	3200	3200	3200	3200	3200	3360	3360	3360	3360	3360	3360

MODIFICATIONS
No modifications available for these products.

Door Options								
ALF	CG	CG.BTM	CG.TOP	DPSRR	MD	MD.BTM	MD.TOP	MFO
								•

Finish Techniques	
Distressing	Heirlooming
•	•

<b>JWHCA3030</b>	3245	3245	3245	3245	3245	3245	3245	3245	3245	3245	3405	3405	3405	3405	3405	3405
<b>JWHCA3630</b>	3506	3506	3506	3506	3506	3506	3506	3506	3506	3506	3682	3682	3682	3682	3682	3682

MODIFICATIONS
No modifications available for these products.

Door Options								
ALF	CG	CG.BTM	CG.TOP	DPSRR	MD	MD.BTM	MD.TOP	MFO
								•

Finish Techniques	
Distressing	Heirlooming
•	•

<b>WHCS30</b>	2645	2645	2645	2645	2645	2645	2645	2645	2645	2645	2778	2778	2778	2778	2778	2778
<b>WHCS36</b>	2858	2858	2858	2858	2858	2858	2858	2858	2858	2858	3000	3000	3000	3000	3000	3000

MODIFICATIONS
No modifications available for these products.

Door Options								
ALF	CG	CG.BTM	CG.TOP	DPSRR	MD	MD.BTM	MD.TOP	MFO
								•

Finish Techniques	
Distressing	Heirlooming
•	•

<b>JWHCS3030</b>	2897	2897	2897	2897	2897	2897	2897	2897	2897	2897	3043	3043	3043	3043	3043	3043
<b>JWHCS3630</b>	3129	3129	3129	3129	3129	3129	3129	3129	3129	3129	3285	3285	3285	3285	3285	3285

MODIFICATIONS
No modifications available for these products.

Door Options								
ALF	CG	CG.BTM	CG.TOP	DPSRR	MD	MD.BTM	MD.TOP	MFO
								•

Finish Techniques	
Distressing	Heirlooming
•	•

**NEW** STRAIGHT BATTEN WOOD HOOD, 30" or 36" WIDE, 24" HIGH

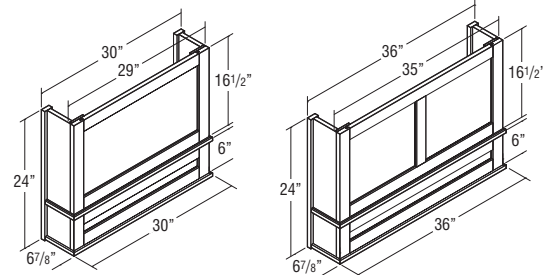

Model	1	2	3	4	5	6
WHSBATTEN3024	2885	2885	2885	2885	2885	2885
WHSBATTEN3624	3174	3174	3174	3174	3174	3174

- Install between adjacent cabinets.
- Exhaust system not included. Compatible with all Schrock blowers.
- Check local building code and appliance installation specifications for clearance requirements and installation heights above the range.
- Silver metallic liner included. Assembly required.
- Installation instructions and hardware included.
- Liner opening size: 10 1/4" deep by 19 1/2" wide.
- End rails, side stiles, and center stiles are 2 1/4" wide with a shaker profile.
- Grain runs vertical on center panels in upper section and horizontal on center panel in lower section.
- Wood hoods ordered in Rustic Alder and Rustic Hickory will not feature Rustic characteristics.
- No changes or cancellations will be accepted after 24 hours from acknowledgment of order.

Model	7	8	9	10	11	12	13	14	15	16	17	18
WHSBATTEN3024	2885	2885	2885	2885	2885	2885	2885	2885	2885	2885	2885	2885
WHSBATTEN3624	3174	3174	3174	3174	3174	3174	3174	3174	3174	3174	3174	3174

MODIFICATIONS	
No modifications available for these products.	

**Finish Techniques**

Distressing	Heirlooming
•	•

**NEW** STRAIGHT BATTEN WOOD HOOD, 30", 36", or 42" WIDE, 36" HIGH

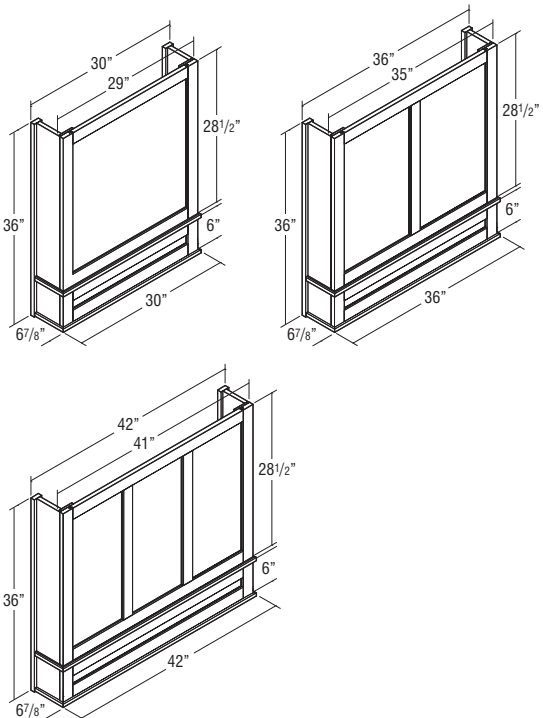

Model	3550	3550	3550	3550	3550	3550
WHSBATTEN3036	3550	3550	3550	3550	3550	3550
WHSBATTEN3636	3976	3976	3976	3976	3976	3976
WHSBATTEN4236	4374	4374	4374	4374	4374	4374

- Install between adjacent cabinets.
- Exhaust system not included. Compatible with all Schrock blowers.
- Check local building code and appliance installation specifications for clearance requirements and installation heights above the range.
- Silver metallic liner included. Assembly required.
- Installation instructions and hardware included.
- Liner opening size: 10 1/4" deep by 19 1/2" wide.
- End rails, side stiles, and center stiles are 2 1/4" wide with a shaker profile.
- Grain runs vertical on center panels in upper section and horizontal on center panel in lower section.
- Wood hoods ordered in Rustic Alder and Rustic Hickory will not feature Rustic characteristics.
- No changes or cancellations will be accepted after 24 hours from acknowledgment of order.

Model	3550	3550	3550	3550	3550	3550	3550	3550	3550	3550	3550	3550
WHSBATTEN3036	3550	3550	3550	3550	3550	3550	3550	3550	3550	3550	3550	3550
WHSBATTEN3636	3976	3976	3976	3976	3976	3976	3976	3976	3976	3976	3976	3976
WHSBATTEN4236	4374	4374	4374	4374	4374	4374	4374	4374	4374	4374	4374	4374

MODIFICATIONS	
No modifications available for these products.	

**Finish Techniques**

Distressing	Heirlooming
•	•

**TAPERED WOOD HOOD,  
30" or 36" WIDE, 24" HIGH**

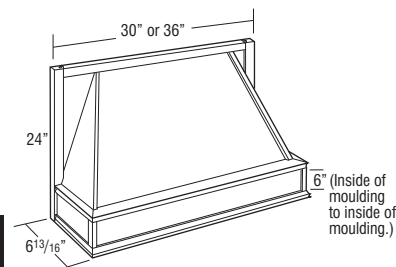

Model	1	2	3	4	5	6
<b>TWH30</b>	1408	1408	1408	1408	1408	1408
<b>TWH36FW</b>	1540	1540	1540	1540	1540	1540

- Wood hoods are designed for use with decorative overlays.
- Install Wood Hood between adjacent cabinets.
- Exhaust system not included. Compatible with all Schrock blowers.
- Check your local building code for installation heights above the range.
- Tapered design.
- Liner opening size: 10 1/4" deep x 19 1/2" wide.
- Silver metallic liner included, not available for order separately.
- Wood hoods ordered in Rustic Alder and Rustic Hickory will not feature Rustic characteristics.

Model	7	8	9	10	11	12	13	14	15	16	17	18
<b>TWH30</b>	1408	1408	1408	1408	1408	1408	1408	1408	1408	1408	1408	1408
<b>TWH36FW</b>	1540	1540	1540	1540	1540	1540	1540	1540	1540	1540	1540	1540

MODIFICATIONS	
No modifications available for these products.	

**Finish Techniques**

Distressing	Heirlooming
•	

BLOWER1100	8229	8229	8229	8229	8229	8229	8229	8229	8229	8229	8229	8229

MODIFICATIONS	
No modifications available for these products.	

**WOOD HOOD BLOWER, 1100 CFM**

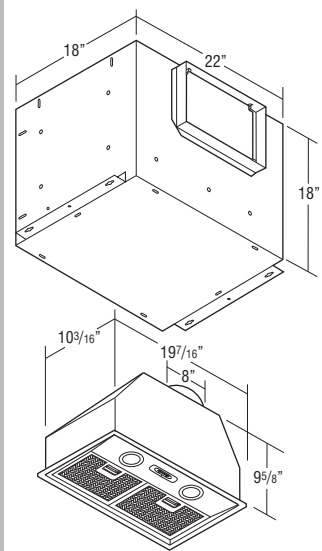

BLOWER1100	8229	8229	8229	8229	8229	8229

- 1100 CFM.
- One year warranty.
- Ventilator housing unit features stainless steel finish.
- Two 50 watt (120 volt) halogen lamps included.
- Satellite blower installs remotely in the interior of the home (i.e., unfinished attic area).
- Designed to work independently from internal blowers.
- Installation instructions, warranty, and repair information included.
- External ventilation required.
- Professional installation required.
- Compatible with all Wood Hoods and Hearths.
- Includes two in-line transitions (8" x 12" to 10" round).
- Includes two removable dishwasher safe grease filters.
- Designed for use in applications up to 110,000 BTUs.

**WOOD HOOD BLOWER, 500 CFM**

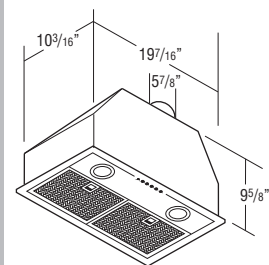

BLOWER500	4516	4516	4516	4516	4516	4516

- 500 CFM.
- One year warranty.
- Sound rating is 8.2 sones.
- Two 20 watt (12 volt, G4 base) halogen lamps included.
- Installation instructions, warranty, and repair information included.
- Silver metallic finish.
- Three speed push button control.
- Includes two removable dishwasher safe grease filters.
- Compatible with all Wood Hoods and Hearths.
- Designed for use in applications up to 60,000 BTUs.

**WOOD HOOD BLOWER, 390 CFM**

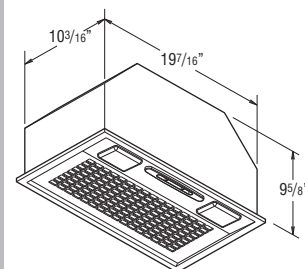

TWHBLOWER390	1696	1696	1696	1696	1696	1696

- Range Hood Component Package has 3-speed centrifugal fan and lighted filter control.
- 6" diameter vent.
- 1 year warranty.
- Sound rating is 6 sones.
- Uses 3.2 amps.
- Two 40 watt candelabra lights required, but not included.
- Compatible with all Wood Hoods and Hearths.
- Silver metallic exterior finish.
- Includes removable dishwasher safe grease filter.

BLOWER500	4516	4516	4516	4516	4516	4516	4516	4516	4516	4516	4516	4516

MODIFICATIONS	
No modifications available for these products.	

TWHBLOWER390	1696	1696	1696	1696	1696	1696	1696	1696	1696	1696	1696	1696

MODIFICATIONS	
No modifications available for these products.	

**WOOD HOOD BLOWER, 250 CFM**

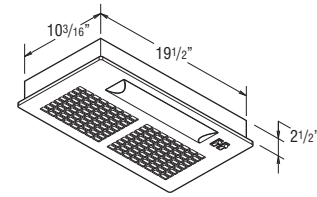

Model	1	2	3	4	5	6
<b>TWHBLOWER250</b>	892	892	892	892	892	892

- Range Hood Component Package has 2-speed single axial fan with lighted filter control.
- 7" diameter vent.
- 1 year warranty.
- Sound rating is 8 sones.
- Uses 2.1 amps.
- Two 40 watt candelabra lights required, but not included.
- Compatible with all Wood Hoods and Hearths.
- Silver metallic exterior finish.
- Includes removable dishwasher safe grease filter.

Model	7	8	9	10	11	12	13	14	15	16	17	18
<b>TWHBLOWER250</b>	892	892	892	892	892	892	892	892	892	892	892	892

MODIFICATIONS
No modifications available for these products.

CONVERSION	286	286	286	286	286	286	286	286	286	286	286	286
<b>FILTER250/390</b>	47	47	47	47	47	47	47	47	47	47	47	47
<b>FILTER500</b>	275	275	275	275	275	275	275	275	275	275	275	275

MODIFICATIONS
No modifications available for these products.

**WOOD HOOD DUCTLESS CONVERSION KIT AND FILTER KITS**

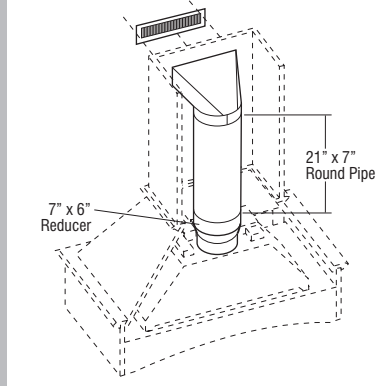

CONVERSION	286	286	286	286	286	286
<b>FILTER250/390</b>	47	47	47	47	47	47
<b>FILTER500</b>	275	275	275	275	275	275

- Must order charcoal filter with CONVERSION kit for proper filtration to replace metal mesh filters included with blower unit.
- FILTER250/390 required when CONVERSION is used with TWHBLOWER250/TWHBLOWER390.
- FILTER500 required when CONVERSION is used with BLOWER500.
- CONVERSION includes: (1) 21" x 7" round pipe, (1) adjustable collar, (1) white metal soffit grille (11 3/8" x 3 5/8"), (1) adjustable boot, (1) 7" x 6" reducer, and installation instructions.



**HEARTH, 48" HIGH, 21" DEEP**

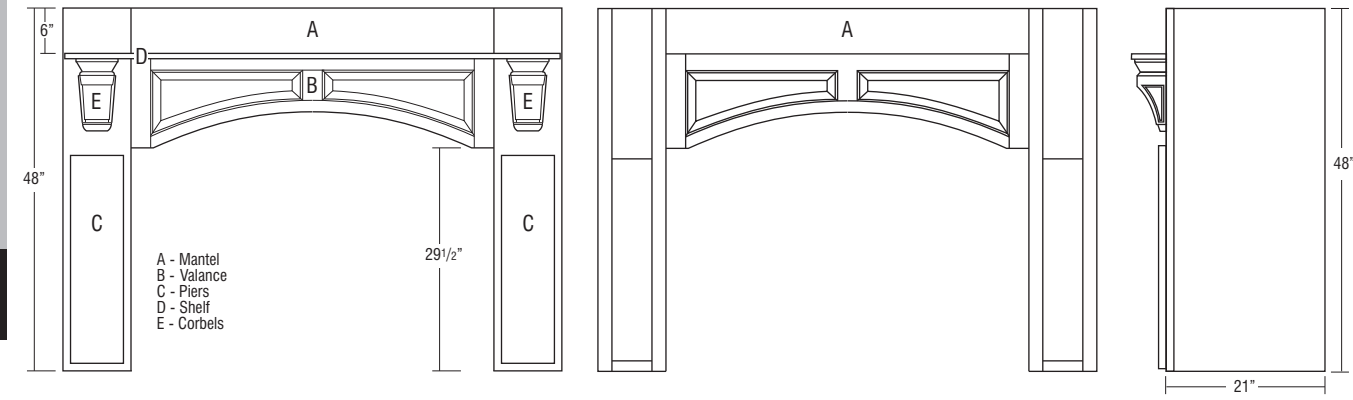

• Recommended clearance of 7"-12" on each side of gas burner to combustible surface, 3"-6" from non-combustible surfaces including the backsplash surface and 30" from the vent. Reference local codes before installation.

**HEARTH, 51" HIGH, 21" DEEP**

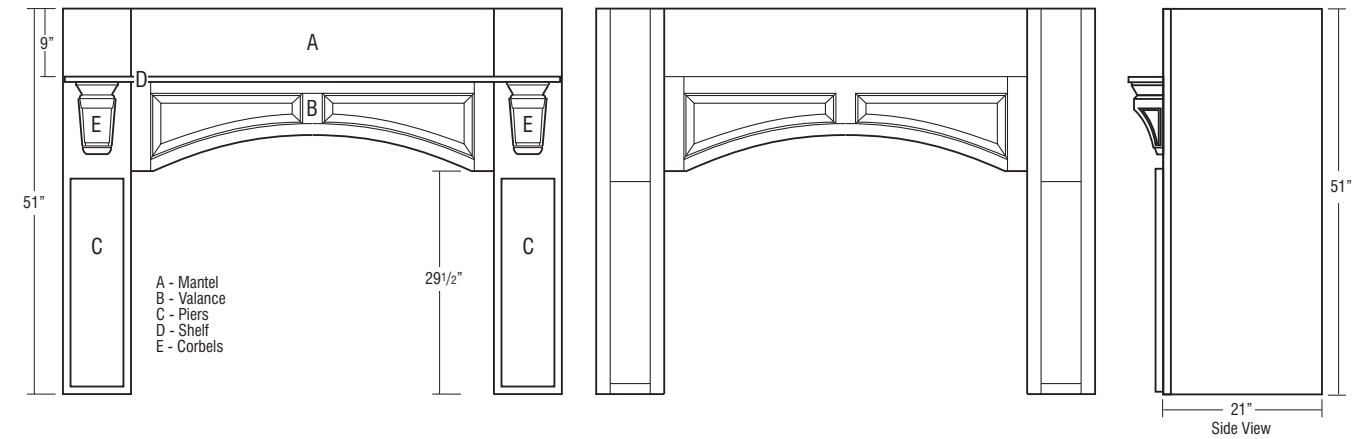

• Recommended clearance of 7"-12" on each side of gas burner to combustible surface, 3"-6" from non-combustible surfaces including the backsplash surface and 30" from the vent. Reference local codes before installation.

**HEARTH, 54" HIGH, 21" DEEP**

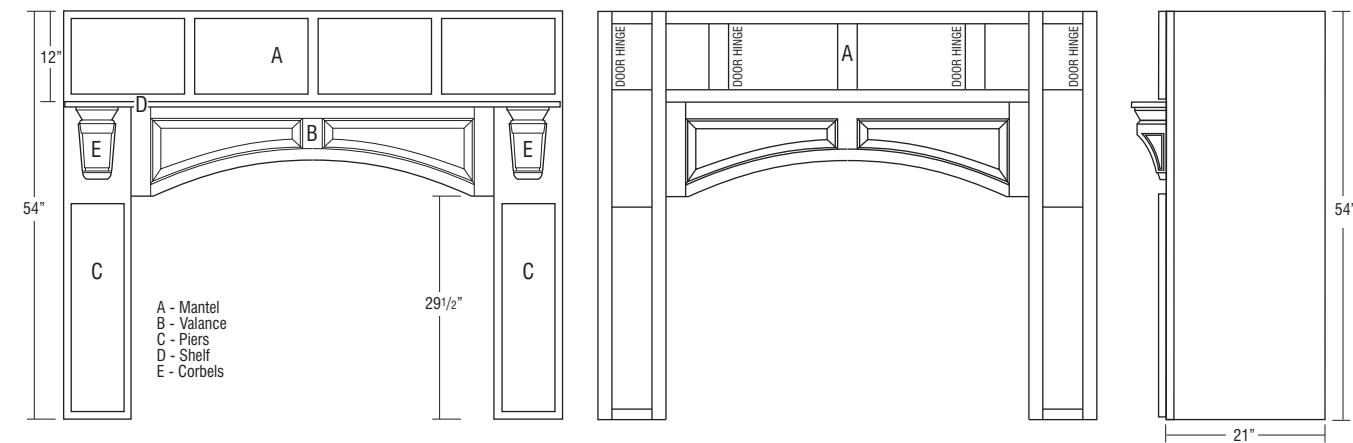

• Recommended clearance of 7"-12" on each side of gas burner to combustible surface, 3"-6" from non-combustible surfaces including the backsplash surface and 30" from the vent. Reference local codes before installation.

		Hearth Width					
		48"	54"	60"	66"	72"	78"
48" High	Pier (left)	HP94821L or HPP94821	HP94821L or HPP94821	HP94821L or HPP94821	HP94821L or HPP94821	HP94821L or HPP94821	HP94821L or HPP94821
	Pier (right)	HP94821R or HPP94821	HP94821R or HPP94821	HP94821R or HPP94821	HP94821R or HPP94821	HP94821R or HPP94821	HP94821R or HPP94821
	Mantel	HM306	HM366	HM426	HM486	HM546	HM606
	Valance	JRPV30 or JRCPV30	JRPV36 or JRCPV36	JRPV42 or JRCPV42	JRPV48 or JRCPV48	JRPV54 or JRCPV54	JRPV60 or JRCPV60
	Corbel (2 Qty)	CORBELMIS9	CORBELMIS9	CORBELMIS9	CORBELMIS9	CORBELMIS9	CORBELMIS9
	Shelf	HS48	HS54	HS60	HS66	HS72	HS78
	Hood Liner	HL30	HL36	HL42	HL48	HL54	HL60
Blower		All blowers are compatible					

		Hearth Width					
		48"	54"	60"	66"	72"	78"
51" High	Pier (left)	HP95121L or HPP95121	HP95121L or HPP95121	HP95121L or HPP95121	HP95121L or HPP95121	HP95121L or HPP95121	HP95121L or HPP95121
	Pier (right)	HP95121R or HPP95121	HP95121R or HPP95121	HP95121R or HPP95121	HP95121R or HPP95121	HP95121R or HPP95121	HP95121R or HPP95121
	Mantel	HM309	HM369	HM429	HM489	HM549	HM609
	Valance	JRPV30 or JRCPV30	JRPV36 or JRCPV36	JRPV42 or JRCPV42	JRPV48 or JRCPV48	JRPV54 or JRCPV54	JRPV60 or JRCPV60
	Corbel (2 Qty)	CORBELMIS9	CORBELMIS9	CORBELMIS9	CORBELMIS9	CORBELMIS9	CORBELMIS9
	Shelf	HS48	HS54	HS60	HS66	HS72	HS78
	Hood Liner	HL30	HL36	HL42	HL48	HL54	HL60
Blower		All blowers are compatible					

		Hearth Width					
		48"	54"	60"	66"	72"	78"
54" High	Pier (left)	HP95421L or HPP95421	HP95421L or HPP95421	HP95421L or HPP95421	HP95421L or HPP95421	HP95421L or HPP95421	HP95421L or HPP95421
	Pier (right)	HP95421R or HPP95421	HP95421R or HPP95421	HP95421R or HPP95421	HP95421R or HPP95421	HP95421R or HPP95421	HP95421R or HPP95421
	Mantel	HM3012	HM3612	HM4212	HM4812	HM5412	HM6012
	Valance	JRPV30 or JRCPV30	JRPV36 or JRCPV36	JRPV42 or JRCPV42	JRPV48 or JRCPV48	JRPV54 or JRCPV54	JRPV60 or JRCPV60
	Corbel (2 Qty)	CORBELMIS9	CORBELMIS9	CORBELMIS9	CORBELMIS9	CORBELMIS9	CORBELMIS9
	Shelf	HS48	HS54	HS60	HS66	HS72	HS78
	Hood Liner	HL30	HL36	HL42	HL48	HL54	HL60
Blower		All blowers are compatible					

**HEARTH, 57" HIGH, 21" DEEP**

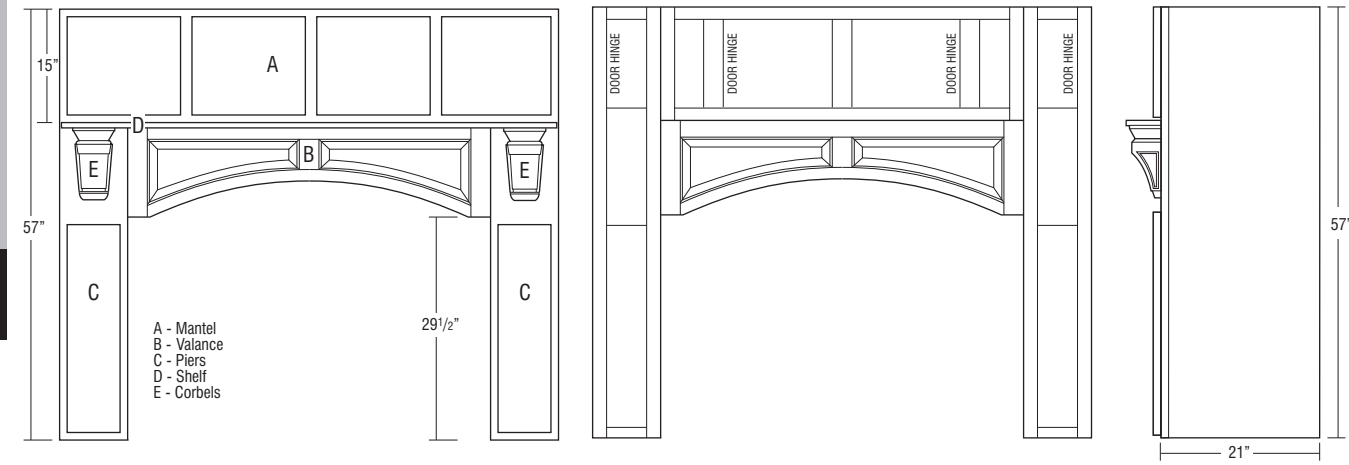

• Recommended clearance of 7"-12" on each side of gas burner to combustible surface, 3"-6" from non-combustible surfaces including the backsplash surface and 30" from the vent. Reference local codes before installation.

**HEARTH, 60" HIGH, 21" DEEP**

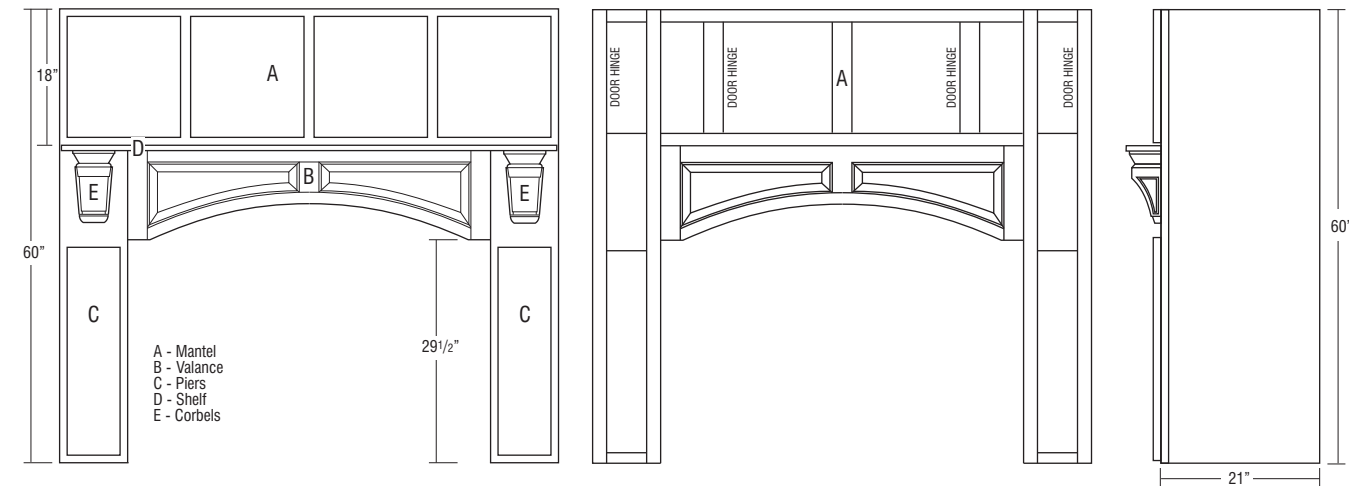

• Recommended clearance of 7"-12" on each side of gas burner to combustible surface, 3"-6" from non-combustible surfaces including the backsplash surface and 30" from the vent. Reference local codes before installation.

**HEARTH (FLOATING), 36" HIGH, 21" DEEP**

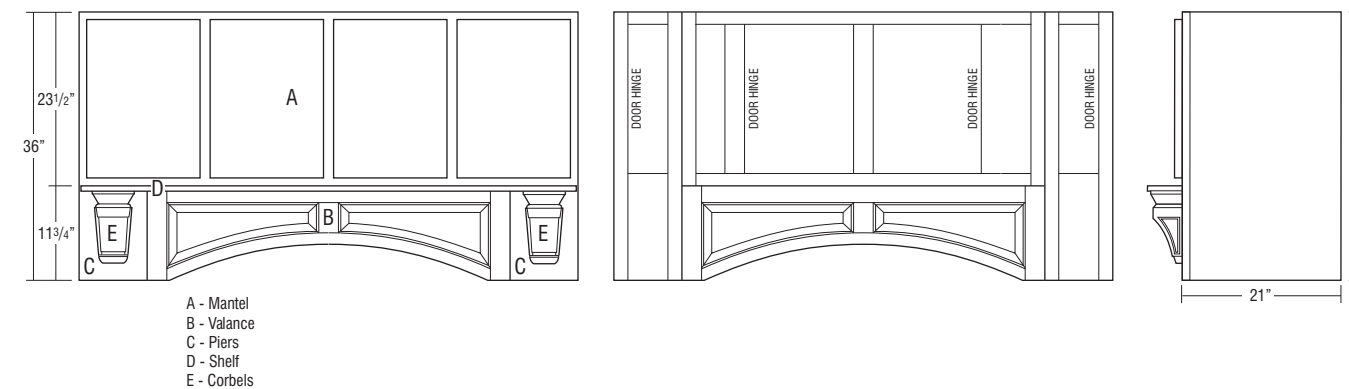

• Cabinets must be fully supported by screws in a structural member in the ceiling or soffit, and into adjacent cabinets.

		Hearth Width					
		48"	54"	60"	66"	72"	78"
57" High	Pier (left)	HP95721L or HPP95721	HP95721L or HPP95721	HP95721L or HPP95721	HP95721L or HPP95721	HP95721L or HPP95721	HP95721L or HPP95721
	Pier (right)	HP95721R or HPP95721	HP95721R or HPP95721	HP95721R or HPP95721	HP95721R or HPP95721	HP95721R or HPP95721	HP95721R or HPP95721
	Mantel	HM3015	HM3615	HM4215	HM4815	HM5415	HM6015
	Valance	JRPV30 or JRCPV30	JRPV36 or JRCPV36	JRPV42 or JRCPV42	JRPV48 or JRCPV48	JRPV54 or JRCPV54	JRPV60 or JRCPV60
	Corbel (2 Qty)	CORBELMIS9	CORBELMIS9	CORBELMIS9	CORBELMIS9	CORBELMIS9	CORBELMIS9
	Shelf	HS48	HS54	HS60	HS66	HS72	HS78
	Hood Liner	HL30	HL36	HL42	HL48	HL54	HL60
	Blower	All blowers are compatible					

		Hearth Width					
		48"	54"	60"	66"	72"	78"
60" High	Pier (left)	HP96021L or HPP96021	HP96021L or HPP96021	HP96021L or HPP96021	HP96021L or HPP96021	HP96021L or HPP96021	HP96021L or HPP96021
	Pier (right)	HP96021R or HPP96021	HP96021R or HPP96021	HP96021R or HPP96021	HP96021R or HPP96021	HP96021R or HPP96021	HP96021R or HPP96021
	Mantel	HM3018	HM3618	HM4218	HM4818	HM5418	HM6018
	Valance	JRPV30 or JRCPV30	JRPV36 or JRCPV36	JRPV42 or JRCPV42	JRPV48 or JRCPV48	JRPV54 or JRCPV54	JRPV60 or JRCPV60
	Corbel (2 Qty)	CORBELMIS9	CORBELMIS9	CORBELMIS9	CORBELMIS9	CORBELMIS9	CORBELMIS9
	Shelf	HS48	HS54	HS60	HS66	HS72	HS78
	Hood Liner	HL30	HL36	HL42	HL48	HL54	HL60
	Blower	All blowers are compatible					

		Hearth Width					
		48"	54"	60"	66"	72"	78"
36" High	Pier (left)	HP93621	HP93621	HP93621	HP93621	HP93621	HP93621
	Pier (right)	HP93621	HP93621	HP93621	HP93621	HP93621	HP93621
	Mantel	HM3023.5	HM3623.5	HM4223.5	HM4823.5	HM5423.5	HM6023.5
	Valance	JRPV30 or JRCPV30	JRPV36 or JRCPV36	JRPV42 or JRCPV42	JRPV48 or JRCPV48	JRPV54 or JRCPV54	JRPV60 or JRCPV60
	Corbel (2 Qty)	CORBELMIS9	CORBELMIS9	CORBELMIS9	CORBELMIS9	CORBELMIS9	CORBELMIS9
	Shelf	HS48	HS54	HS60	HS66	HS72	HS78
	Hood Liner	HL30	HL36	HL42	HL48	HL54	HL60
	Blower	All blowers are compatible					

**HEARTH PIER, 9" WIDE, 36" HIGH**

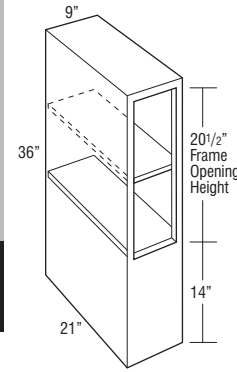

Model	1	2	3	4	5	6
HP93621	928	928	928	928	928	928

- Matching Interior Plywood (MIP) standard.
- Designed for use with a floating hearth application.
- Not available in Rustic Hickory.
- Recommended for use with 24" high Mantel and 9" high Corbels.

**HEARTH PIER, 9" WIDE, 21" DEEP, 48", 51", 54", 57", or 60" HIGH**

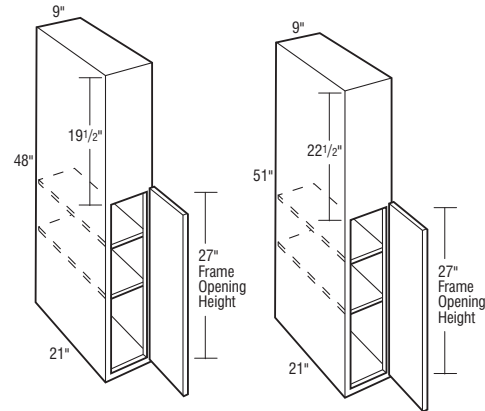

HP94821 L or R

HP95121 L or R

HP94821 L or R	684	736	831	938	837	1071
HP95121 L or R	756	808	903	1011	910	1140
HP95421 L or R	824	877	970	1081	980	1212
HP95721 L or R	888	946	1047	1166	1056	1305
HP96021 L or R	965	1017	1113	1220	1119	1349

- When ordered in Arch door styles, door will be Square.
- Not available in Rustic Hickory.
- Recommended for use with hearth mantels and 9" high corbels, see pages 222-225 for mantel height recommendation.

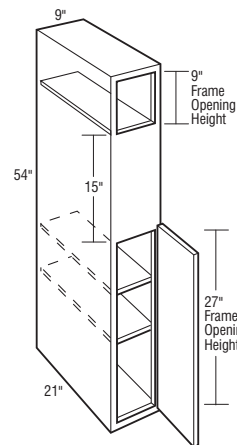

HP95421 L or R

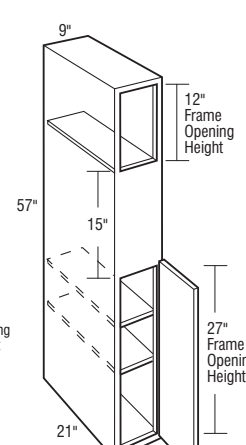

HP95721 L or R

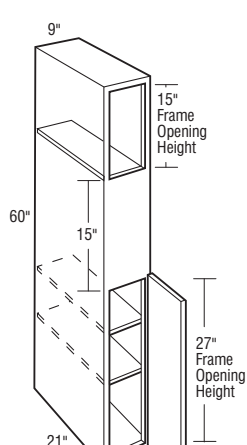

HP96021 L or R

Model	7	8	9	10	11	12	13	14	15	16	17	18
HP93621	928	928	928	928	928	928	928	928	928	928	928	928

**Custom Modifications**

ADDTK	AUTHL AUTHR	CBO	CCO	CFNTO	CFRMO	CND	EXBKL EXBKR	EXL EXR	FB	FFDL	FPEB	ID	INVFRM	MIP	P	PFINBTMB	RD	TD	TVRAV TVRFV TVRVV	WLI
		STD		•	•		•				STD	•		STD			•			

**Construction Upgrades**

APC	PE

**Door Options**

ALF	CG	CG.BTM	CG.TOP	DPSRR	MD	MD.BTM	MD.TOP	MFO

HP94821 L or R	1034	1138	1166	1216	1228	1254	1309	1313	1371	1410	1476	1537
HP95121 L or R	1112	1211	1237	1286	1300	1325	1378	1382	1442	1481	1546	1607
HP95421 L or R	1188	1279	1306	1355	1371	1394	1449	1452	1511	1551	1616	1681
HP95721 L or R	1283	1381	1407	1463	1477	1504	1562	1566	1628	1674	1743	1810
HP96021 L or R	1342	1421	1447	1496	1511	1537	1592	1595	1651	1692	1754	1827

**Custom Modifications**

ADDTK	AUTHL AUTHR	CBO	CCO	CFNTO	CFRMO	CND	EXBKL EXBKR	EXL EXR	FB	FFDL	FPEB	ID	INVFRM	MIP	P	PFINBTMB	RD	TD	TVRAV TVRFV TVRVV	WLI
			•	•	•		•				STD	•		•			•			•

**Construction Upgrades**

APC	PE
•	

**Door Options**

ALF	CG	CG.BTM	CG.TOP	DPSRR	MD	MD.BTM	MD.TOP	MFO
				•				

**HEARTH PIER with PULL-OUT,  
9" WIDE, 21" DEEP,  
48", 51", 54", 57", or 60" HIGH**

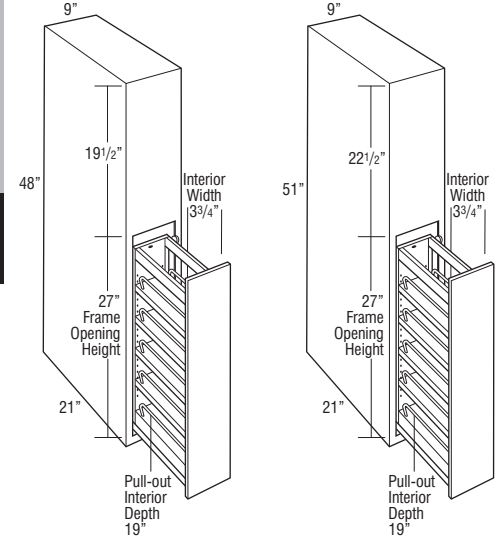

HPP94821

HPP95121

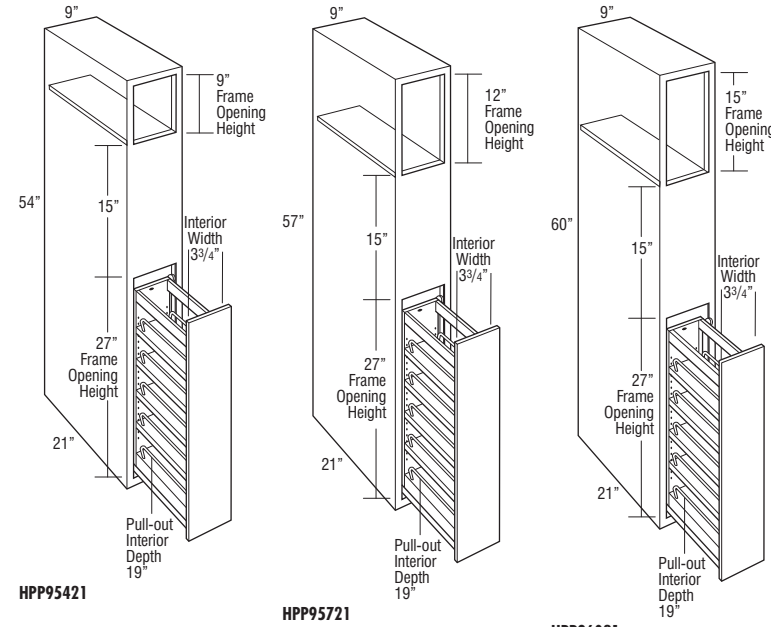

HPP95421

HPP95721

HPP96021

Model	1	2	3	4	5	6
HPP94821	1247	1299	1394	1501	1400	1634
HPP95121	1318	1370	1465	1573	1472	1703
HPP95421	1387	1440	1533	1644	1543	1774
HPP95721	1451	1509	1609	1729	1618	1867
HPP96021	1527	1579	1675	1783	1682	1911

- Includes a natural finish Smart Stop full extension wood pull-out with adjustable shelves and chrome rail sides.
- For full access from both sides of unit, do not install against a wall or next to deeper appliances and cabinets.
- When ordered in Arch door styles, door will be Square.
- Not available in Rustic Hickory.
- Recommended for use with hearth mantels and 9" high corbels, see pages 222-225 for mantel height recommendation.

Model	7	8	9	10	11	12	13	14	15	16	17	18
HPP94821	1597	1701	1729	1779	1791	1816	1871	1876	1934	1973	2039	2099
HPP95121	1674	1773	1800	1849	1862	1888	1941	1945	2004	2044	2108	2170
HPP95421	1751	1842	1868	1917	1934	1956	2011	2014	2074	2113	2179	2243
HPP95721	1846	1944	1970	2026	2040	2067	2125	2129	2191	2237	2305	2373
HPP96021	1904	1984	2009	2058	2074	2099	2154	2157	2214	2254	2317	2389

**Custom Modifications**

ADDTK	AUTHL AUTHR	CBO	CCO	CFNTO	CFRMO	CND	EXBKL EXBKR	EXL EXR	FB	FFDL	FPEB	ID	INVFRM	MIP	P	PFINBTMB	RD	TD	TVRAV TVRFV TVRVV	WLI
		•	•	•	•		•				STD	•		•						•

**Construction Upgrades**

APC	PE
•	

**Door Options**

ALF	CG	CG.BTM	CG.TOP	DPSRR	MD	MD.BTM	MD.TOP	MFO
				•				

**HEARTH MANTEL, 6" or 9" HIGH**

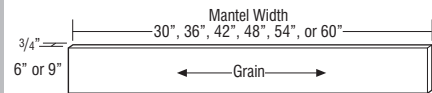

Model	1	2	3	4	5	6
HM306	84	84	84	84	84	84
HM366	105	105	105	105	105	105
HM426	121	121	121	121	121	121
HM486	142	142	142	142	142	142
HM546	161	161	161	161	161	161
HM606	181	181	181	181	181	181
HM309	126	126	126	126	126	126
HM369	156	156	156	156	156	156
HM429	183	183	183	183	183	183
HM489	212	212	212	212	212	212
HM549	242	242	242	242	242	242
HM609	273	273	273	273	273	273

- Recommended for use with 48" or 51" high Hearth Piers and same width Raised or Recessed Panel Arched Valance (see page 222).
- Not available in Rustic Hickory.

**HEARTH MANTEL, 12" HIGH**

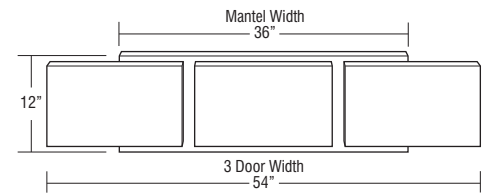
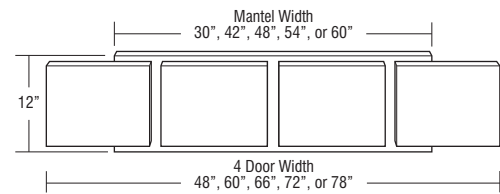

HM3012	787	818	882	966	991	1030
HM3612	815	845	928	1016	1049	1086
HM4212	847	880	975	1074	1107	1145
HM4812	996	1040	1164	1290	1389	1382
HM5412	1082	1125	1248	1375	1473	1465
HM6012	1166	1211	1333	1458	1556	1550

- Recommended for use with 54" high Hearth Piers and same width Raised or Recessed Panel Arched Valance (see page 222).
- Not available in Rustic Hickory.
- Doors for Hearth Mantel are included. Field installation required for attachment of outer doors to Hearth Piers.

**HEARTH MANTEL, 15" HIGH**

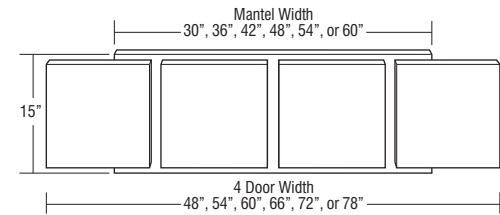

HM3015	860	886	956	1037	1062	1099
HM3615	884	918	998	1086	1121	1158
HM4215	919	951	1046	1142	1176	1217
HM4815	1069	1112	1232	1361	1458	1452
HM5415	1153	1197	1317	1446	1545	1538
HM6015	1237	1279	1403	1529	1627	1622

- Recommended for use with 57" high Hearth Piers and same width Raised or Recessed Panel Arched Valance (see page 224).
- Not available in Rustic Hickory.
- Doors for Hearth Mantel are included. Field installation required for attachment of outer doors to Hearth Piers.

Model	7	8	9	10	11	12	13	14	15	16	17	18
HM306	84	84	84	84	84	84	84	84	84	84	84	84
HM366	105	105	105	105	105	105	105	105	105	105	105	105
HM426	121	121	121	121	121	121	121	121	121	121	121	121
HM486	142	142	142	142	142	142	142	142	142	142	142	142
HM546	161	161	161	161	161	161	161	161	161	161	161	161
HM606	181	181	181	181	181	181	181	181	181	181	181	181
HM309	126	126	126	126	126	126	126	126	126	126	126	126
HM369	156	156	156	156	156	156	156	156	156	156	156	156
HM429	183	183	183	183	183	183	183	183	183	183	183	183
HM489	212	212	212	212	212	212	212	212	212	212	212	212
HM549	242	242	242	242	242	242	242	242	242	242	242	242
HM609	273	273	273	273	273	273	273	273	273	273	273	273

MODIFICATIONS	
No modifications available for these products.	

**Finish Techniques**

Distressing	Heirlooming
•	•

HM3012	1062	1069	1082	1113	1118	1134	1165	1168	1202	1225	1262	1311
HM3612	1118	1131	1144	1178	1184	1200	1233	1237	1274	1298	1339	1392
HM4212	1179	1194	1211	1245	1253	1270	1308	1311	1349	1379	1423	1479
HM4812	1420	1445	1464	1509	1518	1544	1590	1597	1647	1683	1738	1806
HM5412	1512	1529	1549	1595	1602	1627	1675	1682	1733	1767	1824	1896
HM6012	1604	1613	1634	1680	1687	1710	1755	1766	1815	1851	1906	1982

MODIFICATIONS	
No modifications available for these products.	

**Door Options**

ALF	CG	CG.BTM	CG.TOP	DPSRR	MD	MD.BTM	MD.TOP	MFO
				•				•

**Finish Techniques**

Distressing	Heirlooming
•	•

HM3015	1139	1138	1153	1182	1188	1204	1233	1239	1272	1297	1333	1387
HM3615	1197	1201	1216	1250	1255	1270	1305	1308	1345	1370	1407	1464
HM4215	1258	1264	1279	1314	1324	1341	1378	1382	1422	1450	1493	1552
HM4815	1496	1514	1537	1579	1590	1613	1659	1666	1718	1752	1807	1881
HM5415	1592	1600	1619	1664	1674	1698	1744	1751	1802	1837	1893	1966
HM6015	1683	1684	1705	1750	1757	1783	1830	1836	1887	1922	1977	2056

MODIFICATIONS	
No modifications available for these products.	

**Door Options**

ALF	CG	CG.BTM	CG.TOP	DPSRR	MD	MD.BTM	MD.TOP	MFO
				•				•

**Finish Techniques**

Distressing	Heirlooming
•	•

HEARTH MANTEL, 18" HIGH

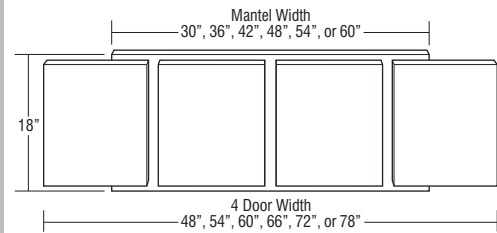

Model	1	2	3	4	5	6
HM3018	928	960	1024	1107	1133	1169
HM3618	958	987	1069	1158	1189	1226
HM4218	988	1020	1116	1214	1248	1287
HM4818	1137	1181	1304	1430	1529	1522
HM5418	1222	1266	1389	1514	1613	1605
HM6018	1308	1349	1475	1600	1698	1692

- Recommended for use with 60" high Hearth Piers and same width Raised or Recessed Panel Arched Valance (see page 224).
- Not available in Rustic Hickory.
- Doors for Hearth Mantel are included. Field installation required for attachment of outer doors to Hearth Piers.

HEARTH MANTEL, 23 1/2" HIGH

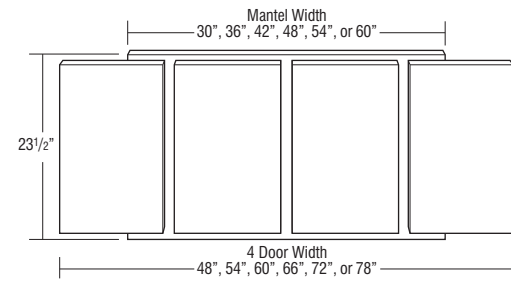

HM3023.5	1069	1098	1165	1248	1272	1309
HM3623.5	1096	1126	1209	1297	1330	1368
HM4223.5	1128	1162	1255	1351	1388	1427
HM4823.5	1277	1321	1445	1571	1668	1662
HM5423.5	1363	1404	1528	1655	1752	1746
HM6023.5	1448	1491	1614	1741	1838	1833

- Recommended for use with 36" high Hearth Piers and same width Raised or Recessed Panel Arched Valance (see page 224).
- Not available in Rustic Hickory.
- Doors for Hearth Mantel are included. Field installation required for attachment of outer doors to Hearth Piers.

HEARTH SHELF, 4 1/2" DEEP

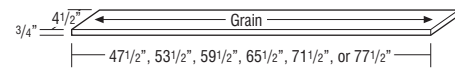

HS48	154	154	154	154	154	154
HS54	172	172	172	172	172	172
HS60	193	193	193	193	193	193
HS66	210	210	210	210	210	210
HS72	231	231	231	231	231	231
HS78	250	250	250	250	250	250

- Shelves will install on top of corbels and will slightly overlay the Raised or Recessed Panel Arched Valance.
- Shelf width should match the overall hearth width (pier width + Mantel/valance width).
- Actual shelf width is 1/2" shorter than the dimension in the product code.
- Shelf finished on one long edge, two short edges, top, and bottom.
- Not available in Rustic Hickory.
- If ordered with Heirlooming Technique, will not feature sand-through characteristics.

HEARTH LINER

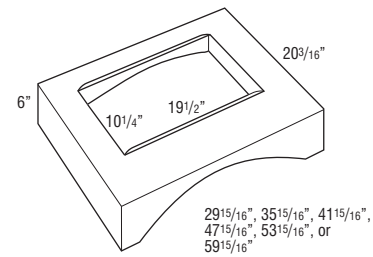

HL30	1135	1135	1135	1135	1135	1135
HL36	1147	1147	1147	1147	1147	1147
HL42	1164	1164	1164	1164	1164	1164
HL48	1179	1179	1179	1179	1179	1179
HL54	1425	1425	1425	1425	1425	1425
HL60	1478	1478	1478	1478	1478	1478

- Liner is metallic silver.
- Compatible with all blowers.
- Mounts to wall and adjoining cabinets.
- Recommended for use with Raised or Recessed Panel Arched Valance.

Model	7	8	9	10	11	12	13	14	15	16	17	18
HM3018	1218	1211	1222	1253	1259	1274	1305	1309	1342	1367	1400	1457
HM3618	1272	1270	1286	1319	1327	1341	1376	1378	1416	1439	1479	1540
HM4218	1335	1335	1348	1385	1393	1410	1448	1451	1492	1519	1562	1624
HM4818	1574	1584	1604	1650	1658	1684	1731	1738	1789	1825	1879	1954
HM5418	1666	1668	1690	1735	1744	1768	1811	1824	1873	1907	1960	2039
HM6018	1760	1753	1777	1821	1831	1853	1899	1907	1957	1994	2047	2129

MODIFICATIONS
No modifications available for these products.

Door Options								
ALF	CG	CG.BTM	CG.TOP	DPSRR	MD	MD.BTM	MD.TOP	MFO
				•				•

Finish Techniques	
Distressing	Heirlooming
•	•

HM3023.5	1356	1348	1363	1393	1398	1416	1446	1449	1481	1506	1542	1603
HM3623.5	1413	1408	1426	1458	1465	1480	1515	1518	1554	1578	1619	1684
HM4223.5	1475	1475	1490	1523	1534	1551	1589	1593	1632	1659	1702	1770
HM4823.5	1714	1725	1745	1791	1798	1825	1869	1877	1927	1963	2016	2098
HM5423.5	1806	1808	1831	1874	1884	1908	1953	1961	2012	2046	2100	2184
HM6023.5	1900	1895	1915	1960	1970	1994	2039	2046	2097	2132	2187	2274

MODIFICATIONS
No modifications available for these products.

Door Options								
ALF	CG	CG.BTM	CG.TOP	DPSRR	MD	MD.BTM	MD.TOP	MFO
				•				•

Finish Techniques	
Distressing	Heirlooming
•	•

HS48	154	154	154	154	154	154	154	154	154	154	154	154
HS54	172	172	172	172	172	172	172	172	172	172	172	172
HS60	193	193	193	193	193	193	193	193	193	193	193	193
HS66	210	210	210	210	210	210	210	210	210	210	210	210
HS72	231	231	231	231	231	231	231	231	231	231	231	231
HS78	250	250	250	250	250	250	250	250	250	250	250	250

MODIFICATIONS
No modifications available for these products.

HL30	1135	1135	1135	1135	1135	1135	1135	1135	1135	1135	1135	1135
HL36	1147	1147	1147	1147	1147	1147	1147	1147	1147	1147	1147	1147
HL42	1164	1164	1164	1164	1164	1164	1164	1164	1164	1164	1164	1164
HL48	1179	1179	1179	1179	1179	1179	1179	1179	1179	1179	1179	1179
HL54	1425	1425	1425	1425	1425	1425	1425	1425	1425	1425	1425	1425
HL60	1478	1478	1478	1478	1478	1478	1478	1478	1478	1478	1478	1478

MODIFICATIONS
No modifications available for these products.

## BASE CABINET NOMENCLATURE

All Base Cabinets are 34 1/2" high and 24" deep unless otherwise noted.

**B24**

Cabinet Type      Cabinet Width

All Base Cabinets are available in Square Cabinet Styles only.

## TOEKICKS

Base Cabinets are shipped with an unfinished toekick. Finished toekicks in matching wood veneer or laminate must be ordered separately and field installed.

## MODIFICATIONS GRID KEY

- Available
- STD Standard on these cabinets
- S** Smart Solutions™ Organization Cabinet
- 5 DAY** 5 Day Express Response Item

## CUSTOM MODIFICATIONS

Mod.	Description	Mod.	Description	Mod.	Description
AUTHL	Authentic End - Left	EXL	Extended Sisle - Left	P	Peninsula
AUTHR	Authentic End - Right	EXR	Extended Sisle - Right	PTOWB	Push to Open Wastebasket
CBO	Cabinet Box Only	FB	Finished Ends	RD	Reduced Depth
CCO	Cabinet Case Only	FD	Full Depth Shelf	RECTKALL	Recessed Island Toekick
CFNTO	Cabinet Front Only	FFDL	Face Frame and Door on End - Left	RECTKBK	Recessed Toekick - Back
CFP	Cabinet False Panel			RECTKL	Recessed Toekick - Left
CFRMO	Cabinet Frame Only	FFDR	Face Frame and Door on End - Right	RECTKR	Recessed Toekick - Right
CMAT	CabMat™			RT	Installed Roll Tray
CND	Cabinet with No Door, with Drawer	FPEB	Furniture Finished Plywood Ends	SCPDRW	Scooped Drawer
DRT	Deep Roll Tray	FTK	Flush Toekick	TD	Tray Dividers
DRWPWR	PowerGlide™ Compact Drawer Outlet	FTKAV	Flush Toekick Arch	TOTSSS	Tilt-out Tray, Stainless Steel Slim
DRWSEC	Biometric Secured Drawer	FTKAV	Flush Toekick Arch	TVRAV	Valance Top Rail, Arch
DRWTK	Toekick Drawer	FTKAV	Flush Toekick Arch	TVRFV	Valance Top Rail, Furniture
EXBKL	End Extended Back - Left	ID	Increased Depth	TVRVV	Valance Top Rail, Straight
EXBKR	End Extended Back - Right	INVFRM	Inverted Frame	VTK	Void Toekick
		LTI	Light Installed Battery Strip	WLI	White Laminate Interior
		MIP	Matching Interior Plywood		

## CONSTRUCTION UPGRADES

Mod.	Description
APC	All-plywood Construction
ET	EasyTrax™
PE	Plywood Ends

## DOOR OPTIONS

Mod.	Description
CG	Cu+for-glass Doors
DPSRR	Door Panel - Solid Reverse Raised

### BASE SINGLE DOOR

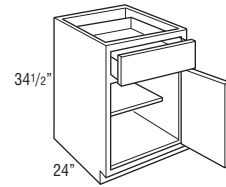

Model	1	2	3	4	5	6
<b>B9 L or R</b>	575	602	660	671	743	771
<b>B12 L or R</b>	651	681	734	771	780	780
<b>B15 L or R</b>	686	716	777	818	818	818
<b>B18 L or R</b>	707	742	797	842	857	864
<b>B21 L or R</b>	743	782	853	898	921	931
<b>B24 L or R</b>	820	862	939	984	993	999

- Adjustable 15" deep shelves.

### BASE PAPER TOWEL CABINET

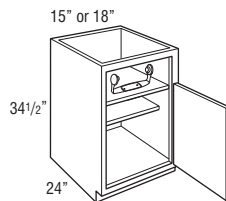

<b>BPT15 L or R</b>	744	774	835	876	876	876
<b>BPT18 L or R</b>	765	800	855	900	915	922

- Upper section of cabinet features an open cubby area with veneer finished interior sides and fixed shelf, a clear and brushed stainless steel paper towel holder, and a storage area behind the paper towel roll for an additional three to four paper towel rolls. Maximum paper towel diameter is 6".
- Cabinet back and lower section of cabinet has standard interior.
- Adjustable 15" deep shelf.

Model	7	8	9	10	11	12	13	14	15	16	17	18
<b>B9 L or R</b>	720	806	818	841	849	865	889	893	924	943	976	1009
<b>B12 L or R</b>	847	820	836	866	871	886	919	924	960	985	1019	1060
<b>B15 L or R</b>	898	862	875	910	915	931	965	969	1008	1032	1072	1114
<b>B18 L or R</b>	927	911	925	961	966	986	1020	1024	1063	1092	1134	1178
<b>B21 L or R</b>	989	984	999	1038	1044	1063	1102	1110	1150	1178	1224	1273
<b>B24 L or R</b>	1082	1053	1075	1115	1123	1142	1186	1190	1237	1269	1317	1371

### Custom Modifications

AUTHL	AUTHR	CBO	CCO	CFNTO	CFP	CFRMO	CMAT	CND	DRT	DRWPWR	DRWSEC	DRWTK	EXBKL	EXBKR	EXL	EXR	FB	FD	FFDL	FFDR	FPEB	FTK	FTKAV	FTKAV	ID	INVFRM	LTI	MIP	P	PTOWB	RD	RECTKALL	RECTKBK	RECTKL	RECTKR	RT	SCPDRW	TD	TOTSSS	TVRAV	TVRFV	TVRVV	VTK	WLI			
•	•	•	•	•	•	•	•	•	•	•	•	•	•	•	•	•	•	•	•	•	•	•	•	•	•	•	•	•	•	•	•	•	•	•	•	•	•	•	•	•	•	•	•	•	•	•	•

\*Not available on 9", 12", and 15" wide    \*Not available on 9" and 12" wide    \*Not available on 9" wide    †Not available on 9", 12", 15", and 18" wide

### Construction Upgrades

APC	ET	PE
•		•

### Door Options

CG	DPSRR
•†	•

†Not available on 9" wide

<b>BPT15 L or R</b>	956	920	933	968	973	989	1023	1027	1066	1090	1130	1172
<b>BPT18 L or R</b>	985	969	983	1019	1024	1044	1078	1082	1121	1150	1192	1236

### Custom Modifications

AUTHL	AUTHR	CBO	CCO	CFNTO	CFP	CFRMO	CMAT	CND	DRT	DRWPWR	DRWSEC	DRWTK	EXBKL	EXBKR	EXL	EXR	FB	FD	FFDL	FFDR	FPEB	FTK	FTKAV	FTKAV	ID	INVFRM	LTI	MIP	P	PTOWB	RD	RECTKALL	RECTKBK	RECTKL	RECTKR	RT	SCPDRW	TD	TOTSSS	TVRAV	TVRFV	TVRVV	VTK	WLI			
•	•	•	•	•	•	•	•	•	•	•	•	•	•	•	•	•	•	•	•	•	•	•	•	•	•	•	•	•	•	•	•	•	•	•	•	•	•	•	•	•	•	•	•	•	•	•	•

\*Not available on 15" wide

### Construction Upgrades

APC	ET	PE
•		•

### Door Options

CG	DPSRR
	•

**BASE DOUBLE DOOR**

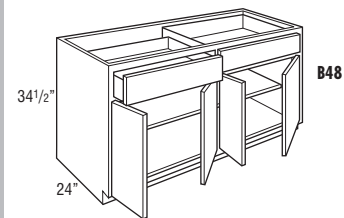
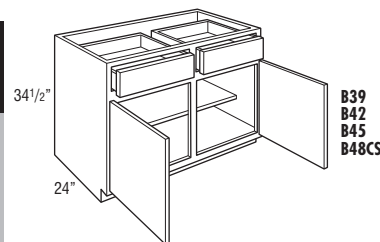
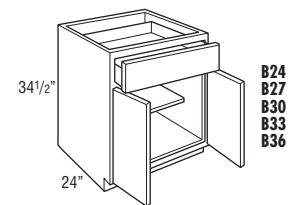

Model	1	2	3	4	5	6
<b>B24</b>	896	938	1029	1068	1068	1068
<b>B27</b>	907	954	1072	1135	1166	1201
<b>B30</b>	962	1011	1126	1195	1216	1254
<b>B33</b>	984	1036	1141	1212	1255	1299
<b>B36</b>	1005	1058	1182	1255	1296	1343
<b>B39</b>	1247	1304	1422	1499	1503	1503
<b>B42</b>	1287	1348	1481	1558	1576	1576
<b>B45</b>	1333	1397	1539	1618	1642	1652
<b>B48CS</b>	1377	1447	1593	1675	1707	1727
<b>B48</b>	1467	1544	1702	1793	1835	1877

• Adjustable 15" deep shelves.

**BASE with CUTLERY INSERT WOOD ORGANIZER**

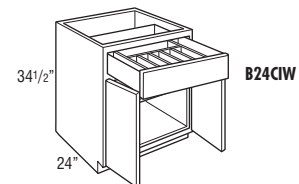
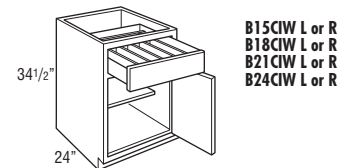

<b>B15CIW L or R</b>	786	816	877	918	918	918
<b>B18CIW L or R</b>	836	871	926	971	986	993
<b>B21CIW L or R</b>	884	923	994	1039	1062	1072
<b>B24CIW L or R</b>	992	1034	1111	1156	1165	1171
<b>B24CIW</b>	1068	1110	1201	1240	1240	1240

• Adjustable 15" deep shelf.  
• Cutlery Insert Wood Organizer is also available as an accessory. See page 580.

Model	7	8	9	10	11	12	13	14	15	16	17	18
<b>B24</b>	1173	1126	1147	1189	1200	1222	1268	1272	1322	1356	1408	1465
<b>B27</b>	1249	1268	1292	1342	1349	1375	1427	1435	1491	1528	1589	1651
<b>B30</b>	1314	1325	1348	1399	1408	1437	1491	1497	1556	1599	1660	1728
<b>B33</b>	1333	1371	1397	1449	1459	1489	1544	1551	1610	1654	1718	1786
<b>B36</b>	1381	1418	1445	1497	1509	1539	1598	1604	1666	1711	1781	1852
<b>B39</b>	1649	1582	1609	1666	1682	1711	1772	1781	1848	1895	1964	2043
<b>B42</b>	1714	1659	1691	1750	1765	1798	1861	1868	1941	1990	2064	2147
<b>B45</b>	1778	1739	1772	1835	1850	1885	1953	1959	2037	2088	2166	2252
<b>B48CS</b>	1842	1818	1853	1921	1933	1972	2042	2051	2131	2184	2267	2357
<b>B48</b>	1971	1978	2013	2089	2103	2144	2223	2233	2319	2378	2470	2567

**Custom Modifications**

AUTHL	AUTHR	CBO	CCO	CFNTO	CFP	CFRMO	CMAT	CND	DRT	DRWPWR	DRWSEC	DRWTK	EXBKL	EXBKR	EXL	EXR	FB	FFDL	FFDR	FPFB	FTK	FTKEV	ID	INFRM	LTI	MIP	P	PTOWB	RD	RECTKALL	RECTKBK	RECTKL	RECTKR	RT	SCPDRW	TD	TOTSSS	TVRAV	TVRFV	TVRVV	VTK	WLI		
•	•	•	•	•	•	•	•	•	•	•	•*	•*	•	•	•	•	•	•	•	•	•	•	•	•	•	•	•	•	•	•	•	•	•	•	•	•	•	•	•	•	•	•	•	•

\*Available only on 24", 42", and 48" wide \*Not available on 39", 42", 45", and 48" wide

**Construction Upgrades**

APC	ET	PE
•	•	•

**Door Options**

CG	DPSRR
•	•

<b>B15CIW L or R</b>	998	962	975	1010	1015	1031	1065	1069	1108	1132	1172	1214
<b>B18CIW L or R</b>	1056	1040	1054	1090	1095	1115	1149	1153	1192	1221	1263	1307
<b>B21CIW L or R</b>	1130	1125	1140	1179	1185	1204	1243	1251	1291	1319	1365	1414
<b>B24CIW L or R</b>	1254	1225	1247	1287	1295	1314	1358	1362	1409	1441	1489	1543
<b>B24CIW</b>	1345	1298	1319	1361	1372	1394	1440	1444	1494	1528	1580	1637

**Custom Modifications**

AUTHL	AUTHR	CBO	CCO	CFNTO	CFP	CFRMO	CMAT	CND	DRT	DRWPWR	DRWSEC	DRWTK	EXBKL	EXBKR	EXL	EXR	FB	FFDL	FFDR	FPFB	FTK	FTKEV	ID	INFRM	LTI	MIP	P	PTOWB	RD	RECTKALL	RECTKBK	RECTKL	RECTKR	RT	SCPDRW	TD	TOTSSS	TVRAV	TVRFV	TVRVV	VTK	WLI			
•	•	•	•	•	•	•	•	•	•	•	•	•*	•	•	•	•	•	•	•	•	•	•	•	•	•	•	•	•	•	•	•	•	•	•	•	•	•	•	•	•	•	•	•	•	•

\*Not available on 15" wide

**Construction Upgrades**

APC	ET	PE
•	•	•

**Door Options**

CG	DPSRR
•	•





**BASE with WOOD TIERED K-CUP\* DRAWER**

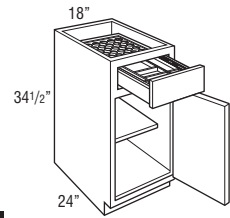

Model	1	2	3	4	5	6
<b>B18KCUP L or R</b>	1178	1213	1268	1313	1328	1335

- Adjustable 15" deep shelf.
  - Holds 40 K-Cups.
  - Exterior Wood Tiered K-Cup drawer box height is 3 3/4", interior height of top tier is 1 5/8", and interior height of bottom tier is 1 3/8".
  - The Wood Tiered K-Cup Drawer is compatible with K-Cup pods only.
  - Wood Tiered K-Cup Drawer is also available as an accessory. See page 581.
- \*K-Cup is a registered trademark of Keurig Green Mountain, Inc.

Model	7	8	9	10	11	12	13	14	15	16	17	18
<b>B18KCUP L or R</b>	1398	1382	1396	1432	1437	1457	1491	1495	1534	1563	1605	1649

**Custom Modifications**

AUTHL	AUTHR	CBO	CCO	CFNTO	CFP	CFRMO	CMAT	CND	DRT	DRWPWR	DRWSEC	DRWTK	EXBKL	EXBKR	EXL	EXR	FB	FFDL	FPEB	FTK	FTKAV	FTKFV	ID	INVRM	LTI	MIP	P	PTOWB	RD	RECTKALL	RECTKLBK	RECTKL	RECTKR	RT	SCPDRW	TD	TOTSSS	TVRAV	TVRFV	TVRVV	VTK	WLI				
•	•	•	•	•	•	•	•	•	•	•	•	•	•	•	•	•	•	•	•	•	•	•	•	•	•	•	•	•	•	•	•	•	•	•	•	•	•	•	•	•	•	•	•	•	•	•

**Construction Upgrades**

APC	ET	PE
•	•	•

**Door Options**

CG	DPSRR
•	•

Model	19	20	21	22	23	24	25	26	27	28	29	30
<b>B6FH L or R</b>	508	589	603	627	633	646	672	675	706	724	753	785

**Custom Modifications**

AUTHL	AUTHR	CBO	CCO	CFNTO	CFP	CFRMO	CMAT	CND	DRT	DRWPWR	DRWSEC	DRWTK	EXBKL	EXBKR	EXL	EXR	FB	FFDL	FPEB	FTK	FTKAV	FTKFV	ID	INVRM	LTI	MIP	P	PTOWB	RD	RECTKALL	RECTKLBK	RECTKL	RECTKR	RT	SCPDRW	TD	TOTSSS	TVRAV	TVRFV	TVRVV	VTK	WLI					
•	•	•	•	•	•	•	•	•	•	•	•	•	•	•	•	•	•	•	•	•	•	•	•	•	•	•	•	•	•	•	•	•	•	•	•	•	•	•	•	•	•	•	•	•	•	•	•

\*Includes VTK

**Construction Upgrades**

APC	ET	PE
•	•	•

**Door Options**

CG	DPSRR
•	•

Model	31	32	33	34	35	36	37	38	39	40	41	42
<b>B9FH L or R</b>	536	621	635	660	667	681	708	711	742	762	793	826
<b>B12FH L or R</b>	577	657	669	696	703	715	747	750	780	803	834	868
<b>B15FH L or R</b>	624	693	707	735	743	757	787	789	823	845	881	918
<b>B18FH L or R</b>	646	736	752	783	787	804	834	840	875	898	935	972
<b>B21FH L or R</b>	706	798	814	844	855	871	908	911	949	974	1015	1053
<b>B24FH L or R</b>	864	884	905	937	947	965	1006	1007	1049	1080	1124	1169

**Custom Modifications**

AUTHL	AUTHR	CBO	CCO	CFNTO	CFP	CFRMO	CMAT	CND	DRT	DRWPWR	DRWSEC	DRWTK	EXBKL	EXBKR	EXL	EXR	FB	FFDL	FPEB	FTK	FTKAV	FTKFV	ID	INVRM	LTI	MIP	P	PTOWB	RD	RECTKALL	RECTKLBK	RECTKL	RECTKR	RT	SCPDRW	TD	TOTSSS	TVRAV	TVRFV	TVRVV	VTK	WLI				
•	•	•	•	•	•	•	•	•	•	•	•	•*	•	•	•	•	•	•	•	•	•	•	•	•	•	•	•	•	•	•	•	•	•	•	•	•	•	•	•	•	•	•	•	•	•	•

\*Not available on 9", 12", and 15" wide    \*Not available on 9" and 12" wide    \*Not available on 9" wide

**Construction Upgrades**

APC	ET	PE
•	•	•

**Door Options**

CG	DPSRR
• <sup>†</sup>	•

<sup>†</sup>Not available on 9" wide

**FULL HEIGHT BASE SINGLE DOOR, 6" WIDE**

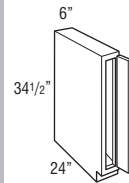

Model	1	2	3	4	5	6
<b>B6FH L or R</b>	372	399	452	464	533	558

- Frame opening is 3" wide.
- Cabinet has a full top panel.
- Utilizes a 5 1/2" wide overlay filler as a hinged door for full and partial overlay styles.
- When FFDL or FFDR modification is selected, the VTK modification will automatically be selected.

**FULL HEIGHT BASE SINGLE DOOR**

9", 12", 15", 18", 21", or 24"

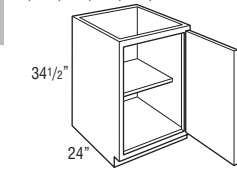

Model	1	2	3	4	5	6
<b>B9FH L or R</b>	391	420	476	488	561	588
<b>B12FH L or R</b>	420	448	494	525	589	618
<b>B15FH L or R</b>	452	479	531	568	621	653
<b>B18FH L or R</b>	471	502	555	588	661	695
<b>B21FH L or R</b>	503	534	603	640	718	755
<b>B24FH L or R</b>	617	655	740	784	868	834

- Adjustable 15" deep shelf.

**BASE PAPER TOWEL CABINET FULL HEIGHT**

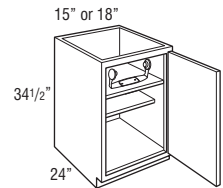

Model	1	2	3	4	5	6
<b>BPT15FH L or R</b>	765	800	855	900	915	922
<b>BPT18FH L or R</b>	801	840	911	956	979	989

- Upper section of cabinet features an open cubby area with veneer finished interior sides and fixed shelf, a clear and brushed stainless steel paper towel holder, and a storage area behind the paper towel roll for an additional three to four paper towel rolls. Maximum paper towel diameter is 6".
- Cabinet back and lower section of cabinet has standard interior.
- Adjustable 15" deep shelf.

Model	7	8	9	10	11	12	13	14	15	16	17	18
<b>BPT15FH L or R</b>	985	969	983	1019	1024	1044	1078	1082	1121	1150	1192	1236
<b>BPT18FH L or R</b>	1047	1042	1057	1096	1102	1121	1160	1168	1208	1236	1282	1331

**Custom Modifications**

AUTHL	AUTHR	CBO	CCO	CFNTO	CFP	CFRMO	CMAT	CND	DRT	DRWPWR	DRWSEC	DRWTK	EXBKL	EXBKR	EXL	EXR	FB	FFDL	FPEB	FTK	FTKAV	FTKFV	ID	INVRM	LTI	MIP	P	PTOWB	RD	RECTKALL	RECTKLBK	RECTKL	RECTKR	RT	SCPDRW	TD	TOTSSS	TVRAV	TVRFV	TVRVV	VTK	WLI				
•	•	•	•	•	•	•	•	•	•	•	•	•*	•	•	•	•	•	•	•	•	•	•	•	•	•	•	•	•	•	•	•	•	•	•	•	•	•	•	•	•	•	•	•	•	•	•

\*Not available on 15" wide

**Construction Upgrades**

APC	ET	PE
•	•	•

**Door Options**

CG	DPSRR
•	•

**FULL HEIGHT BASE SINGLE DOOR, 40 1/2" HIGH**

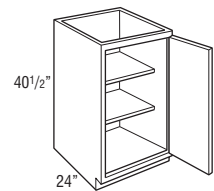

Model	1	2	3	4	5	6
<b>B940FH L or R</b>	818	844	905	915	987	1015
<b>B1240FH L or R</b>	893	924	976	1015	1023	1023
<b>B1540FH L or R</b>	929	961	1019	1060	1060	1060
<b>B1840FH L or R</b>	950	986	1041	1086	1099	1105
<b>B2140FH L or R</b>	987	1024	1095	1141	1165	1174
<b>B2440FH L or R</b>	1063	1102	1183	1225	1237	1245

• Two adjustable 15" deep shelves.

Model	7	8	9	10	11	12	13	14	15	16	17	18
<b>B940FH L or R</b>	964	1047	1060	1085	1092	1107	1134	1137	1168	1187	1220	1252
<b>B1240FH L or R</b>	1091	1063	1081	1110	1115	1132	1163	1168	1202	1226	1263	1304
<b>B1540FH L or R</b>	1141	1102	1119	1153	1160	1174	1209	1214	1251	1274	1314	1355
<b>B1840FH L or R</b>	1170	1154	1169	1203	1211	1227	1264	1268	1306	1336	1377	1423
<b>B2140FH L or R</b>	1231	1225	1245	1280	1289	1306	1346	1350	1394	1423	1469	1516
<b>B2440FH L or R</b>	1325	1298	1317	1356	1367	1388	1429	1435	1480	1512	1560	1613

**Custom Modifications**

AUTHL	AUTHR	CBO	CCO	CFNTO	CFP	CFRMO	CMAT	CND	DRT	DRWPWR	DRWSEC	DRWTK	EXBKL	EXBKR	EXL	EXR	FB	FD	FFDL	FPEB	FTK	FTKAV	FTKRV	ID	INVFRM	LTI	MIP	P	PTOWB	RD	RECTKALL	RECTKLBK	RECTKL	RECTKR	RT	SCPDRW	TD	TOTSSS	TVRAV	TVRFV	TVRVV	VTK	WLI		
•	•	•	•	•	•	•	•	•	•	•	•	•*	•	•	•	•	•	•	•	•	•	•	•*	•	•	•	•	•	•	•	•	•	•	•	•	•	•	•	•	•	•	•	•	•	•

\*Not available on 9", 12", and 15" wide    \*Not available on 9" and 12" wide    \*Not available on 9" wide

**Construction Upgrades**

APC	ET	PE
•	•	•

**Door Options**

CG	DPSRR
•†	•

†Not available on 9" wide

**FULL HEIGHT BASE DOUBLE DOOR**

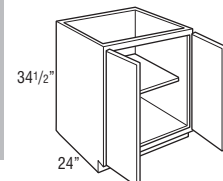

**B24FH**  
**B27FH**  
**B30FH**  
**B33FH**  
**B36FH**

<b>B24FH</b>	650	688	780	824	914	878
<b>B27FH</b>	652	697	801	852	950	998
<b>B30FH</b>	702	748	854	906	993	1043
<b>B33FH</b>	716	764	867	918	1030	1085
<b>B36FH</b>	743	790	905	959	1069	1123

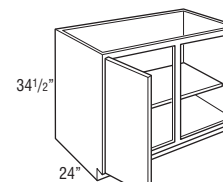

**B39FH**  
**B42FH**  
**B45FH**  
**B48FHCS**

<b>B39FH</b>	790	841	950	1008	1132	1187
<b>B42FH</b>	826	879	1000	1062	1195	1254
<b>B45FH</b>	868	923	1050	1115	1266	1322
<b>B48FHCS</b>	910	967	1099	1168	1336	1390

• Adjustable 15" deep shelf.

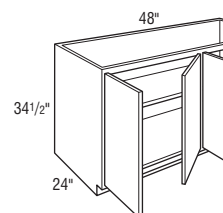

**B48FH**

<b>B48FH</b>	991	1053	1198	1273	1477	1523
--------------	-----	------	------	------	------	------

<b>B24FH</b>	909	931	950	988	996	1016	1057	1059	1103	1136	1183	1229
<b>B27FH</b>	935	1058	1080	1124	1133	1154	1200	1209	1258	1290	1343	1396
<b>B30FH</b>	993	1105	1131	1174	1184	1211	1258	1263	1315	1349	1406	1463
<b>B33FH</b>	1009	1147	1174	1220	1228	1256	1306	1313	1368	1401	1462	1520
<b>B36FH</b>	1052	1187	1213	1260	1272	1296	1347	1351	1408	1449	1509	1571

<b>B39FH</b>	1110	1259	1284	1335	1346	1374	1429	1436	1495	1535	1598	1661
<b>B42FH</b>	1168	1329	1354	1407	1423	1449	1508	1515	1578	1624	1691	1757
<b>B45FH</b>	1226	1400	1427	1484	1501	1528	1591	1597	1664	1711	1782	1853
<b>B48FHCS</b>	1285	1472	1502	1560	1576	1606	1671	1679	1749	1799	1873	1949

<b>B48FH</b>	1400	1616	1647	1712	1729	1765	1835	1842	1918	1973	2054	2136
--------------	------	------	------	------	------	------	------	------	------	------	------	------

**Custom Modifications**

AUTHL	AUTHR	CBO	CCO	CFNTO	CFP	CFRMO	CMAT	CND	DRT	DRWPWR	DRWSEC	DRWTK	EXBKL	EXBKR	EXL	EXR	FB	FD	FFDL	FPEB	FTK	FTKAV	FTKRV	ID	INVFRM	LTI	MIP	P	PTOWB	RD	RECTKALL	RECTKLBK	RECTKL	RECTKR	RT	SCPDRW	TD	TOTSSS	TVRAV	TVRFV	TVRVV	VTK	WLI					
•	•	•	•	•	•	•	•	•	•	•	•	•*	•	•	•	•	•	•	•	•	•	•	•	•	•	•	•	•	•	•	•	•	•	•	•	•	•	•	•	•	•	•	•	•	•	•	•	•

\*Not available on 39", 42", 45", and 48" wide

**Construction Upgrades**

APC	ET	PE
•	•	•

**Door Options**

CG	DPSRR
•	•

**FULL HEIGHT BASE DOUBLE DOOR, 40 1/2" HIGH**

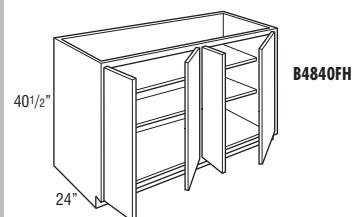
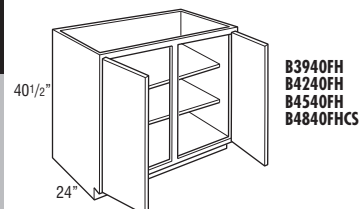
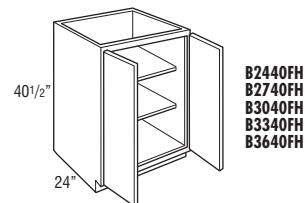

Model	1	2	3	4	5	6
B2440FH	1139	1182	1271	1310	1310	1310
B2740FH	1147	1197	1314	1378	1407	1445
B3040FH	1204	1254	1371	1438	1458	1497
B3340FH	1225	1278	1387	1453	1499	1544
B3640FH	1248	1302	1426	1499	1540	1588

B3940FH	1490	1548	1664	1743	1746	1746
B4240FH	1530	1594	1725	1801	1819	1819
B4540FH	1575	1642	1782	1859	1885	1895
B4840FHCS	1621	1690	1836	1919	1950	1971

B4840FH	1710	1786	1947	2036	2078	2122
---------	------	------	------	------	------	------

• Two adjustable 15" deep shelves.

**WALL BASE SINGLE DOOR**

12", 15", 18", 21", or 24"

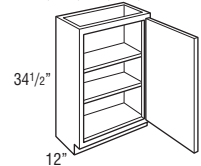

WB12 L or R	420	448	494	525	589	618
WB15 L or R	452	479	531	568	621	653
WB18 L or R	471	502	555	588	661	695
WB21 L or R	503	534	603	640	718	755
WB24 L or R	617	655	740	784	868	834

• Two full depth shelves.  
• Will have the same shelf hole drill pattern as a base cabinet.

Model	7	8	9	10	11	12	13	14	15	16	17	18
B2440FH	1419	1371	1392	1432	1443	1465	1511	1515	1565	1601	1654	1709
B2740FH	1492	1511	1537	1584	1595	1618	1669	1679	1734	1771	1832	1895
B3040FH	1557	1567	1594	1644	1654	1681	1734	1742	1799	1842	1903	1971
B3340FH	1575	1613	1641	1692	1703	1732	1786	1795	1855	1897	1960	2029
B3640FH	1624	1659	1687	1742	1752	1782	1840	1849	1910	1955	2024	2095

B3940FH	1893	1827	1854	1910	1924	1955	2014	2024	2090	2138	2208	2288
B4240FH	1957	1902	1935	1995	2007	2041	2104	2112	2183	2233	2307	2389
B4540FH	2023	1983	2015	2079	2093	2129	2198	2205	2278	2331	2410	2496
B4840FHCS	2086	2062	2097	2162	2179	2215	2288	2295	2375	2427	2510	2600

B4840FH	2214	2220	2258	2332	2349	2387	2468	2477	2563	2620	2713	2813
---------	------	------	------	------	------	------	------	------	------	------	------	------

**Custom Modifications**

AUTHL	AUTHR	CBO	CCO	CFNTO	CFP	CFRMO	CMAT	CND	DRT	DRWPWR	DRWSEC	DRWTK	EXBKL	EXBKR	EXL	EXR	FB	FD	FFDL	FPEB	FTK	FTKAV	FTKFV	ID	INVRM	LTI	MIP	P	PTOWB	RD	RECTKALL	RECTKLBK	RECTKL	RECTKR	RT	SCPRW	TD	TOTSSS	TVRAV	TVRFV	TVRVV	VTK	WU		
•	•	•	•	•	•	•						•*	•	•	•	•	•	•	•	•	•	•	•	•	•	•	•	•	•	•	•	•	•	•	•	•	•	•	•	•	•	•	•	•	•

\*Not available on 39", 42", 45", and 48" wide

**Construction Upgrades**

APC	ET	PE
•		•

**Door Options**

CG	DPSRR
•	•

WB12 L or R	577	657	669	696	703	715	747	750	780	803	834	868
WB15 L or R	624	693	707	735	743	757	787	789	823	845	881	918
WB18 L or R	646	736	752	783	787	804	834	840	875	898	935	972
WB21 L or R	706	798	814	844	855	871	908	911	949	974	1015	1053
WB24 L or R	864	884	905	937	947	965	1006	1007	1049	1080	1124	1169

**Custom Modifications**

AUTHL	AUTHR	CBO	CCO	CFNTO	CFP	CFRMO	CMAT	CND	DRT	DRWPWR	DRWSEC	DRWTK	EXBKL	EXBKR	EXL	EXR	FB	FD	FFDL	FPEB	FTK	FTKAV	FTKFV	ID	INVRM	LTI	MIP	P	PTOWB	RD	RECTKALL	RECTKLBK	RECTKL	RECTKR	RT	SCPRW	TD	TOTSSS	TVRAV	TVRFV	TVRVV	VTK	WU			
•	•	•	•	•	•	•							•	•	•	•	•	•	•	•	•	•*	•	•	•	•	•	•	•	•	•	•	•	•	•	•	•	•	•	•	•	•	•	•	•	•

\*Not available on 12" wide \*RECTKLBK not available

**Construction Upgrades**

APC	ET	PE
•		•

**Door Options**

CG	DPSRR
•	•





30" SUPERCABINET™ VERSION 2

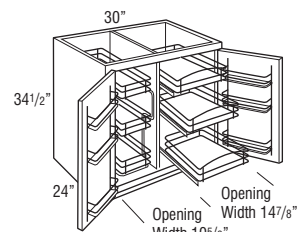

BV2SC30PR

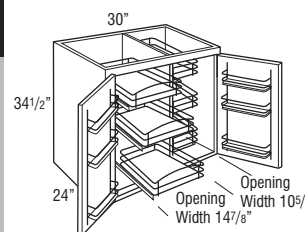

BV2SC30RP

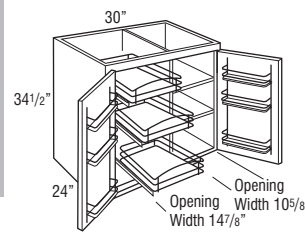

BV2SC30RS

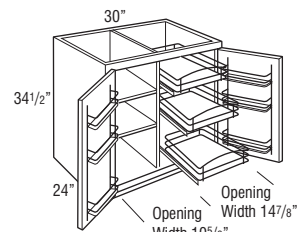

BV2SC30SR

Model	1	2	3	4	5	6
BV2SC30PR	1801	1847	1953	2005	2092	2142
BV2SC30RP	1801	1847	1953	2005	2092	2142
BV2SC30RS	1401	1447	1553	1605	1692	1742
BV2SC30SR	1401	1447	1553	1605	1692	1742

- Nomenclature represents left to right order of interior components.  
Example: BV2SC30RS = Base Version 2 SuperCabinet™ 30" Roll-out Shelves.
- Shelves are adjustable and 20" deep.
- Chrome Roll-out trays feature Smart Stop.
- Cabinets utilize 170° hinge. For sufficient pull-out clearance, 12" of adjacent space is required for door to open 170° when installed near a wall or corner.
- Each door features a chrome and wood three-tiered rack.
- Door rack width is 9 3/8".
- Door rack depth is 3".
- Side pull-outs feature 3 adjustable chrome and wood baskets on frame with Smart Stop.
- Integrated soft-close hinge not included. Premium door mechanism installed.

Model	7	8	9	10	11	12	13	14	15	16	17	18
BV2SC30PR	2092	2204	2230	2273	2283	2310	2357	2362	2414	2448	2505	2562
BV2SC30RP	2092	2204	2230	2273	2283	2310	2357	2362	2414	2448	2505	2562
BV2SC30RS	1692	1804	1830	1873	1883	1910	1957	1962	2014	2048	2105	2162
BV2SC30SR	1692	1804	1830	1873	1883	1910	1957	1962	2014	2048	2105	2162

**Custom Modifications**

AUTHL	AUTHR	CBO	CCO	CFNTD	CFP	CFRMO	CMAT	CND	DRT	DRWPWR	DRWSEC	DRWTK	EXBKL	EXBKR	EXL	EXR	FB	FD	FFDL	FPEB	FTK	FTKAV	FTKFV	ID	INVFRM	LTI	MIP	P	PTOWB	RD	RECTKALL	RECTKBK	RECTKL	RECTKR	RT	SCPRW	TD	TOTSSS	TVRAV	TVRFV	TVRVV	VTK	WLI
•	•	•	•			•						•	•	•	•						•	•	•				•														•	•	

**Construction Upgrades**

APC	ET	PE
•		•

**Door Options**

CG	DPSRR
	•

**BSCG30 L or R**

Model	1838	1950	1976	2020	2029	2055	2102	2108	2160	2193	2251	2307
BSCG30 L or R	1838	1950	1976	2020	2029	2055	2102	2108	2160	2193	2251	2307

**Custom Modifications**

AUTHL	AUTHR	CBO	CCO	CFNTD	CFP	CFRMO	CMAT	CND	DRT	DRWPWR	DRWSEC	DRWTK	EXBKL	EXBKR	EXL	EXR	FB	FD	FFDL	FPEB	FTK	FTKAV	FTKFV	ID	INVFRM	LTI	MIP	P	PTOWB	RD	RECTKALL	RECTKBK	RECTKL	RECTKR	RT	SCPRW	TD	TOTSSS	TVRAV	TVRFV	TVRVV	VTK	WLI
•	•	•	•			•						•	•	•	•							•	•	•				•														•	•

**Construction Upgrades**

APC	ET	PE
•		•

**Door Options**

CG	DPSRR
	•

30" SUPERCABINET™ GOURMET

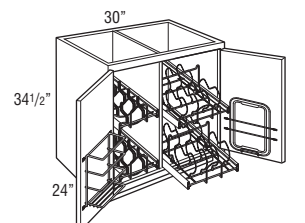

Model	1547	1594	1699	1750	1838	1888
BSCG30 L or R	1547	1594	1699	1750	1838	1888

- Cabinets utilize 170° hinge. For sufficient pull-out clearance, 12" of adjacent space is required for door to open 170° when installed near a wall or corner.
- Integrated soft-close hinge not included. Premium door mechanism included.
- L or R designates lid holder side.
- Left door features wrap/foil rack.
- Right door features cutting board and cutting board storage.
- Lid pull-out capacity is 6 lids per tray. Maximum lid diameter is 8 1/2" on bottom tray and 9 3/4" on top tray.
- Pots and Pans pull-out includes 8 dividers per tray for adjustable storage.
- Cutting board is 9 3/4" x 15 3/5".





36" SUPERCABINET™ VERSION 2

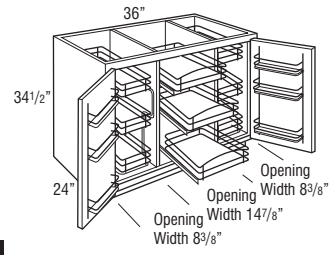

BV2SC36PRP

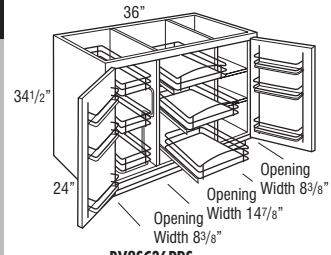

BV2SC36PRS

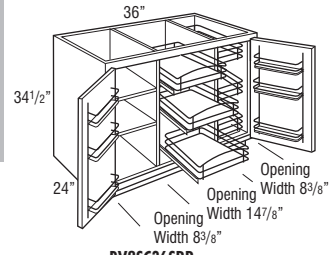

BV2SC36SRP

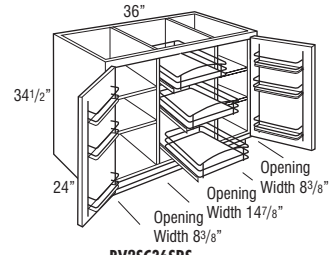

BV2SC36SRS

Model	1	2	3	4	5	6
BV2SC36PRP	2696	2743	2858	2912	3022	3076
BV2SC36PRS	2047	2094	2209	2263	2373	2427
BV2SC36SRP	2047	2094	2209	2263	2373	2427
BV2SC36SRS	1648	1695	1810	1864	1974	2028

- Nomenclature represents left to right order of interior components.  
Example: BV2SC36PRS = Base Version 2 SuperCabinet™ 36" Pull-out Roll-out Shelves.
- Shelves are adjustable and 20" deep.
- Chrome Roll-out trays feature Smart Stop.
- Cabinets utilize 170° hinge. For sufficient pull-out clearance, 12" of adjacent space is required for door to open 170° when installed near a wall or corner.
- Each door features a chrome and wood three-tiered rack.
- Door rack width is 13 7/8".
- Door rack depth is 3".
- Side pull-outs feature 3 adjustable chrome and wood baskets on frame with Smart Stop.
- Integrated soft-close hinge not included. Premium door mechanism installed.

36" SUPERCABINET™ GOURMET

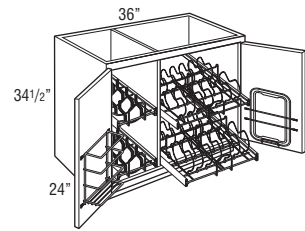

Model	1	2	3	4	5	6
BSCG36 L or R	2054	2101	2215	2269	2380	2434

- Cabinets utilize 170° hinge. For sufficient pull-out clearance, 12" of adjacent space is required for door to open 170° when installed near a wall or corner.
- Integrated soft-close hinge not included. Premium door mechanism included.
- L or R designates lid holder side.
- Left door features wrap/foil rack.
- Right door features cutting board and cutting board storage.
- Lid pull-out capacity is 6 lids per tray. Maximum lid diameter is 8 1/2" on bottom tray and 9 3/4" on top tray.
- Pots and Pans pull-out includes 8 dividers per tray for adjustable storage.
- Cutting board is 9 3/4" x 15 3/5".

Model	7	8	9	10	11	12	13	14	15	16	17	18
BV2SC36PRP	3005	3140	3166	3213	3225	3249	3300	3304	3361	3402	3462	3524
BV2SC36PRS	2356	2491	2517	2564	2576	2600	2651	2655	2712	2753	2813	2875
BV2SC36SRP	2356	2491	2517	2564	2576	2600	2651	2655	2712	2753	2813	2875
BV2SC36SRS	1957	2092	2118	2165	2177	2201	2252	2256	2313	2354	2414	2476

**Custom Modifications**

AUTHL	AUTHR	CBO	CCO	CFNTO	CFP	CFRMO	CMAT	CND	DRT	DRWPWR	DRWSEC	DRWTK	EXBKL	EXL	EXR	FB	FD	FFDL	FPEB	FTK	FTKAV	FTKFEV	ID	INVFRM	LTI	MIP	P	PTOWB	RD	RECTKALL	RECTKBK	RECTKL	RECTKR	RT	SCPDRW	TD	TOTSSS	TVRAV	TVRFV	TVRVV	VTK	WLI			
•	•	•	•	•	•	•	•	•	•	•	•	•	•	•	•	•	•	•	•	•	•	•	•	•	•	•	•	•	•	•	•	•	•	•	•	•	•	•	•	•	•	•	•	•	•

**Construction Upgrades**

APC	ET	PE
•	•	•

**Door Options**

CG	DPSRR
•	•

Model	1	2	3	4	5	6	7	8	9	10	11	12	13	14	15	16	17	18
BSCG36 L or R	2363	2498	2523	2570	2584	2607	2659	2664	2720	2760	2820	2882						

**Custom Modifications**

AUTHL	AUTHR	CBO	CCO	CFNTO	CFP	CFRMO	CMAT	CND	DRT	DRWPWR	DRWSEC	DRWTK	EXBKL	EXL	EXR	FB	FD	FFDL	FPEB	FTK	FTKAV	FTKFEV	ID	INVFRM	LTI	MIP	P	PTOWB	RD	RECTKALL	RECTKBK	RECTKL	RECTKR	RT	SCPDRW	TD	TOTSSS	TVRAV	TVRFV	TVRVV	VTK	WLI			
•	•	•	•	•	•	•	•	•	•	•	•	•	•	•	•	•	•	•	•	•	•	•	•	•	•	•	•	•	•	•	•	•	•	•	•	•	•	•	•	•	•	•	•	•	•

**Construction Upgrades**

APC	ET	PE
•	•	•

**Door Options**

CG	DPSRR
•	•

**BASE with ROLL TRAYS**

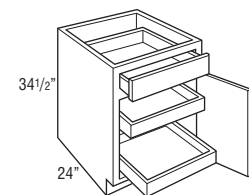

Model	1	2	3	4	5	6
<b>B12RT L or R</b>	1184	1214	1267	1304	1313	1313
<b>B15RT L or R</b>	1219	1249	1310	1351	1351	1351
<b>B18RT L or R</b>	1240	1275	1330	1375	1390	1397
<b>B21RT L or R</b>	1276	1315	1386	1431	1454	1464
<b>B24RT L or R</b>	1353	1395	1472	1517	1526	1532

- 2 roll trays standard.
- Cabinets may accommodate up to 4 roll trays, which may be purchased separately for field installation. See page 586.

**BASE DOUBLE DOOR with ROLL TRAYS**

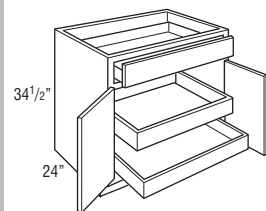

<b>B24RT</b>	1429	1471	1562	1601	1601	1601
<b>B27RT</b>	1440	1487	1605	1668	1699	1734
<b>B30RT</b>	1495	1544	1659	1728	1749	1787
<b>B33RT</b>	1517	1569	1674	1745	1788	1832
<b>B36RT</b>	1538	1591	1715	1788	1829	1876

- 2 roll trays standard.
- Cabinet has butt doors, no center stile.
- Cabinet may accommodate up to 4 roll trays, which may be purchased separately for field installation. See page 586.

**BASE DOUBLE DOOR with ROLL TRAYS**

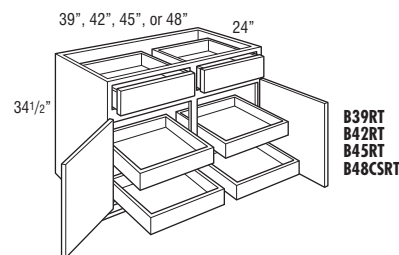

**B39RT  
B42RT  
B45RT  
B48CSRT**

<b>B39RT</b>	2313	2370	2488	2565	2569	2569
<b>B42RT</b>	2353	2414	2547	2624	2642	2642
<b>B45RT</b>	2399	2463	2605	2684	2708	2718
<b>B48CSRT</b>	2443	2513	2659	2741	2773	2793

- 4 roll trays standard.
- Cabinet may accommodate up to 8 roll trays, which may be purchased separately for field installation. See page 586.

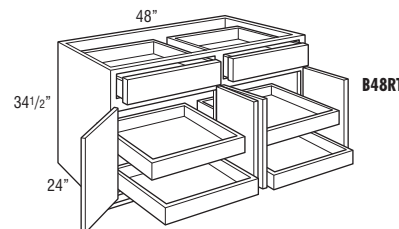

**B48RT**

<b>B48RT</b>	2533	2610	2768	2859	2901	2943
--------------	------	------	------	------	------	------

Model	7	8	9	10	11	12	13	14	15	16	17	18
<b>B12RT L or R</b>	1380	1353	1369	1399	1404	1419	1452	1457	1493	1518	1552	1593
<b>B15RT L or R</b>	1431	1395	1408	1443	1448	1464	1498	1502	1541	1565	1605	1647
<b>B18RT L or R</b>	1460	1444	1458	1494	1499	1519	1553	1557	1596	1625	1667	1711
<b>B21RT L or R</b>	1522	1517	1532	1571	1577	1596	1635	1643	1683	1711	1757	1806
<b>B24RT L or R</b>	1615	1586	1608	1648	1656	1675	1719	1723	1770	1802	1850	1904

**Custom Modifications**

AUTHL	AUTHR	CBO	CCO	CFNTO	CFP	CFRMO	CMAT	CND	DRT	DRWPWR	DRWSEC	DRWTK	EXBKL	EXBKR	EXL	EXR	FB	FD	FFDL	FPEB	FTK	FTKAV	FTKFV	ID	INVRM	LTI	MIP	P	PTOWB	RD	RECTKALL	RECTKLBK	RECTKL	RECTKR	RT	SCPDW	TD	TOTSSS	TVRAV	TVRFV	TVRVV	VTK	WLI	
•	•	•	•	•	•	•		•	•	•*	•*	•*	•	•	•	•	•	•	•	•	•	•	•	•	•	•	•	•	•	•	•	•	•	•	•	•	•	•	•	•	•	•	•	•

\*Not available on 12" and 15" wide \*Not available on 12" wide

**Construction Upgrades**

APC	ET	PE
•	•	•

**Door Options**

CG	DPSRR
•	•

<b>B24RT</b>	1706	1659	1680	1722	1733	1755	1801	1805	1855	1889	1941	1998
<b>B27RT</b>	1782	1801	1825	1875	1882	1908	1960	1968	2024	2061	2122	2184
<b>B30RT</b>	1847	1858	1881	1932	1941	1970	2024	2030	2089	2132	2193	2261
<b>B33RT</b>	1866	1904	1930	1982	1992	2022	2077	2084	2143	2187	2251	2319
<b>B36RT</b>	1914	1951	1978	2030	2042	2072	2131	2137	2199	2244	2314	2385

**Custom Modifications**

AUTHL	AUTHR	CBO	CCO	CFNTO	CFP	CFRMO	CMAT	CND	DRT	DRWPWR	DRWSEC	DRWTK	EXBKL	EXBKR	EXL	EXR	FB	FD	FFDL	FPEB	FTK	FTKAV	FTKFV	ID	INVRM	LTI	MIP	P	PTOWB	RD	RECTKALL	RECTKLBK	RECTKL	RECTKR	RT	SCPDW	TD	TOTSSS	TVRAV	TVRFV	TVRVV	VTK	WLI		
•	•	•	•	•	•	•		•	•	•	•*	•	•	•	•	•	•	•	•	•	•	•	•	•	•	•	•	•	•	•	•	•	•	•	•	•	•	•	•	•	•	•	•	•	•

\*Available only on 24" wide

**Construction Upgrades**

APC	ET	PE
•	•	•

**Door Options**

CG	DPSRR
•	•

<b>B39RT</b>	2715	2648	2675	2732	2748	2777	2838	2847	2914	2961	3030	3109
<b>B42RT</b>	2780	2725	2757	2816	2831	2864	2927	2934	3007	3056	3130	3213
<b>B45RT</b>	2844	2805	2838	2901	2916	2951	3019	3025	3103	3154	3232	3318
<b>B48CSRT</b>	2908	2884	2919	2987	2999	3038	3108	3117	3197	3250	3333	3423

**Custom Modifications**

AUTHL	AUTHR	CBO	CCO	CFNTO	CFP	CFRMO	CMAT	CND	DRT	DRWPWR	DRWSEC	DRWTK	EXBKL	EXBKR	EXL	EXR	FB	FD	FFDL	FPEB	FTK	FTKAV	FTKFV	ID	INVRM	LTI	MIP	P	PTOWB	RD	RECTKALL	RECTKLBK	RECTKL	RECTKR	RT	SCPDW	TD	TOTSSS	TVRAV	TVRFV	TVRVV	VTK	WLI		
•	•	•	•	•	•	•		•	•	•	•*	•	•	•	•	•	•	•	•	•	•	•	•	•	•	•	•	•	•	•	•	•	•	•	•	•	•	•	•	•	•	•	•	•	•

\*Available only on 42" and 48" wide

**Construction Upgrades**

APC	ET	PE
•	•	•

**Door Options**

CG	DPSRR
•	•

**BASE FULL HEIGHT with ROLL TRAYS**

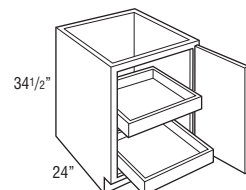

Model	1	2	3	4	5	6
<b>B12FHRT L or R</b>	953	981	1027	1058	1122	1151
<b>B15FHRT L or R</b>	985	1012	1064	1101	1154	1186
<b>B18FHRT L or R</b>	1004	1035	1088	1121	1194	1228
<b>B21FHRT L or R</b>	1036	1067	1136	1173	1251	1288
<b>B24FHRT L or R</b>	1150	1188	1273	1317	1401	1367

- 2 roll trays standard.
- Cabinets may accommodate up to 5 roll trays, which may be purchased separately for field installation. See page 586.

**BASE FULL HEIGHT with ROLL TRAYS, 40 1/2" HIGH**

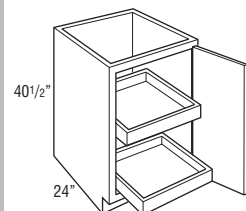

**B1540FHRT L or R  
B1840FHRT L or R  
B2140FHRT L or R  
B2440FHRT L or R**

<b>B1540FHRT L or R</b>	1462	1494	1552	1593	1593	1593
<b>B1840FHRT L or R</b>	1483	1519	1574	1619	1632	1638
<b>B2140FHRT L or R</b>	1520	1557	1628	1674	1698	1707
<b>B2440FHRT L or R</b>	1596	1635	1716	1758	1770	1778
<b>B2440FHRT</b>	1672	1715	1804	1843	1843	1843
<b>B2740FHRT</b>	1680	1730	1847	1911	1940	1978

- 2 roll trays standard.
- Cabinets may accommodate up to 5 roll trays, which may be purchased separately for field installation. See page 586.

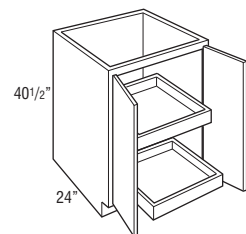

**B2440FHRT  
B2740FHRT**

**BASE FULL HEIGHT with ROLL TRAYS**

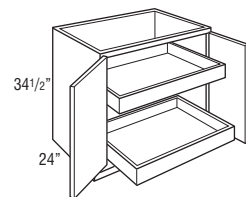

<b>B24FHRT</b>	1183	1221	1313	1357	1447	1411
<b>B27FHRT</b>	1185	1230	1334	1385	1483	1531
<b>B30FHRT</b>	1235	1281	1387	1439	1526	1576
<b>B33FHRT</b>	1249	1297	1400	1451	1563	1618
<b>B36FHRT</b>	1276	1323	1438	1492	1602	1656

- 2 roll trays standard.
- Cabinet has full height butt doors, no center stile.
- Cabinet may accommodate up to 5 roll trays, which may be purchased separately. See page 586.

Model	7	8	9	10	11	12	13	14	15	16	17	18
<b>B12FHRT L or R</b>	1110	1190	1202	1229	1236	1248	1280	1283	1313	1336	1367	1401
<b>B15FHRT L or R</b>	1157	1226	1240	1268	1276	1290	1320	1322	1356	1378	1414	1451
<b>B18FHRT L or R</b>	1179	1269	1285	1316	1320	1337	1367	1373	1408	1431	1468	1505
<b>B21FHRT L or R</b>	1239	1331	1347	1377	1388	1404	1441	1444	1482	1507	1548	1586
<b>B24FHRT L or R</b>	1397	1417	1438	1470	1480	1498	1539	1540	1582	1613	1657	1702

**Custom Modifications**

AUTHL	AUTHR	CBO	CCO	CFNTO	CFP	CFRMO	CMAT	CND	DRT	DRWPWR	DRWSEC	DRWTK	EXBKL	EXBKR	EXL	EXR	FB	FD	FFDL	FFDR	FPEB	FTK	FTKAV	FTKFV	ID	INVFRM	LTI	MIP	P	PTOWB	RD	RECTKALL	RECTKLBK	RECTKL	RECTKR	RT	SCPRW	TD	TOTSSS	TVRAV	TVRFV	TVRVV	VTK	WLI	
•	•	•	•	•	•	•	•	•	•	•	•	•*	•	•	•	•	•	•	•	•	•	•	•	•	•	•	•	•	•	•	•	•	•	•	•	•	•	•	•	•	•	•	•	•	•

\*Not available on 12" and 15" wide

**Construction Upgrades**

APC	ET	PE
•	•	•

**Door Options**

CG	DPSRR
•	•

<b>B1540FHRT L or R</b>	1674	1635	1652	1686	1693	1707	1742	1747	1784	1807	1847	1888
<b>B1840FHRT L or R</b>	1703	1687	1702	1736	1744	1760	1797	1801	1839	1869	1910	1956
<b>B2140FHRT L or R</b>	1764	1758	1778	1813	1822	1839	1879	1883	1927	1956	2002	2049
<b>B2440FHRT L or R</b>	1858	1831	1850	1889	1900	1921	1962	1968	2013	2045	2093	2146
<b>B2440FHRT</b>	1952	1904	1925	1965	1976	1998	2044	2048	2098	2134	2187	2242
<b>B2740FHRT</b>	2025	2044	2070	2117	2128	2151	2202	2212	2267	2304	2365	2428

**Custom Modifications**

AUTHL	AUTHR	CBO	CCO	CFNTO	CFP	CFRMO	CMAT	CND	DRT	DRWPWR	DRWSEC	DRWTK	EXBKL	EXBKR	EXL	EXR	FB	FD	FFDL	FFDR	FPEB	FTK	FTKAV	FTKFV	ID	INVFRM	LTI	MIP	P	PTOWB	RD	RECTKALL	RECTKLBK	RECTKL	RECTKR	RT	SCPRW	TD	TOTSSS	TVRAV	TVRFV	TVRVV	VTK	WLI	
•	•	•	•	•	•	•	•	•	•	•	•	•*	•	•	•	•	•	•	•	•	•	•	•	•	•	•	•	•	•	•	•	•	•	•	•	•	•	•	•	•	•	•	•	•	•

\*Not available on 15" wide

**Construction Upgrades**

APC	ET	PE
•	•	•

**Door Options**

CG	DPSRR
•	•

<b>B24FHRT</b>	1442	1464	1483	1521	1529	1549	1590	1592	1636	1669	1716	1762
<b>B27FHRT</b>	1468	1591	1613	1657	1666	1687	1733	1742	1791	1823	1876	1929
<b>B30FHRT</b>	1526	1638	1664	1707	1717	1744	1791	1796	1848	1882	1939	1996
<b>B33FHRT</b>	1542	1680	1707	1753	1761	1789	1839	1846	1901	1934	1995	2053
<b>B36FHRT</b>	1585	1720	1746	1793	1805	1829	1880	1884	1941	1982	2042	2104

**Custom Modifications**

AUTHL	AUTHR	CBO	CCO	CFNTO	CFP	CFRMO	CMAT	CND	DRT	DRWPWR	DRWSEC	DRWTK	EXBKL	EXBKR	EXL	EXR	FB	FD	FFDL	FFDR	FPEB	FTK	FTKAV	FTKFV	ID	INVFRM	LTI	MIP	P	PTOWB	RD	RECTKALL	RECTKLBK	RECTKL	RECTKR	RT	SCPRW	TD	TOTSSS	TVRAV	TVRFV	TVRVV	VTK	WLI	
•	•	•	•	•	•	•	•	•	•	•	•	•	•	•	•	•	•	•	•	•	•	•	•	•	•	•	•	•	•	•	•	•	•	•	•	•	•	•	•	•	•	•	•	•	•

**Construction Upgrades**

APC	ET	PE
•	•	•

**Door Options**

CG	DPSRR
•	•

**BASE FULL HEIGHT DOUBLE DOOR with ROLL TRAYS**

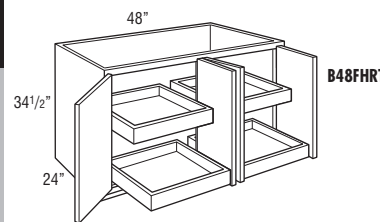
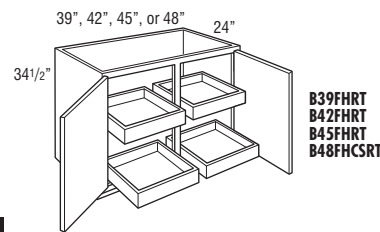

Model	1	2	3	4	5	6
<b>B39FHRT</b>	1856	1907	2016	2074	2198	2253
<b>B42FHRT</b>	1892	1945	2066	2128	2261	2320
<b>B45FHRT</b>	1934	1989	2116	2181	2332	2388
<b>B48FHCSRT</b>	1976	2033	2165	2234	2402	2456
<b>B48FHRT</b>						
	2057	2119	2264	2339	2543	2589

- 4 roll trays standard.
- Cabinet may accommodate up to 10 roll trays, which may be purchased separately. See page 586.

**BASE with CUTLERY INSERT WOOD ORGANIZER and ROLL TRAYS**

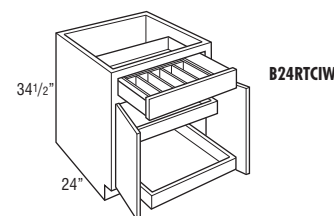
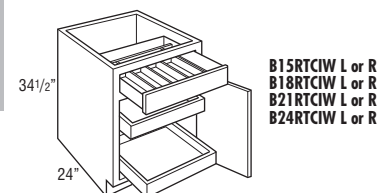

<b>B15RTCIW L or R</b>	1319	1349	1410	1451	1451	1451
<b>B18RTCIW L or R</b>	1369	1404	1459	1504	1519	1526
<b>B21RTCIW L or R</b>	1417	1456	1527	1572	1595	1605
<b>B24RTCIW L or R</b>	1525	1567	1644	1689	1698	1704
<b>B24RTCIW</b>						
	1601	1643	1734	1773	1773	1773

- 2 roll trays standard.
- Cabinets may accommodate up to 4 roll trays, which may be purchased separately for field installation. See page 586.
- Cutlery Insert Wood Organizer is also available as an accessory. See page 580.

Model	7	8	9	10	11	12	13	14	15	16	17	18
<b>B39FHRT</b>	2176	2325	2350	2401	2412	2440	2495	2502	2561	2601	2664	2727
<b>B42FHRT</b>	2234	2395	2420	2473	2489	2515	2574	2581	2644	2690	2757	2823
<b>B45FHRT</b>	2292	2466	2493	2550	2567	2594	2657	2663	2730	2777	2848	2919
<b>B48FHCSRT</b>	2351	2538	2568	2626	2642	2672	2737	2745	2815	2865	2939	3015
<b>B48FHRT</b>												
	2466	2682	2713	2778	2795	2831	2901	2908	2984	3039	3120	3202

**Custom Modifications**

AUTHL	AUTHR	CBO	CCO	CFNTO	CFP	CFRMO	CMAT	CND	DRT	DRWPWR	DRWSEC	DRWTK	EXBKL	EXBKR	EXL	EXR	FB	FD	FFDL	FPEB	FTK	FTKAV	FTKEV	ID	INFRM	LTI	MIP	P	PTOWB	RD	RECTKALL	RECTKBK	RECTKL	RECTKR	RT	SCPDRW	TD	TOTSSS	TVRAV	TVRFV	TVRVV	VTK	WLI		
•	•	•	•	•	•	•	•	•	•	•	•	•	•	•	•	•	•	•	•	•	•	•	•	•	•	•	•	•	•	•	•	•	•	•	•	•	•	•	•	•	•	•	•	•	•

**Construction Upgrades**

APC	ET	PE
•	•	•

**Door Options**

CG	DPSRR
•	•

<b>B15RTCIW L or R</b>	1531	1495	1508	1543	1548	1564	1598	1602	1641	1665	1705	1747
<b>B18RTCIW L or R</b>	1589	1573	1587	1623	1628	1648	1682	1686	1725	1754	1796	1840
<b>B21RTCIW L or R</b>	1663	1658	1673	1712	1718	1737	1776	1784	1824	1852	1898	1947
<b>B24RTCIW L or R</b>	1787	1758	1780	1820	1828	1847	1891	1895	1942	1974	2022	2076
<b>B24RTCIW</b>												
	1878	1831	1852	1894	1905	1927	1973	1977	2027	2061	2113	2170

**Custom Modifications**

AUTHL	AUTHR	CBO	CCO	CFNTO	CFP	CFRMO	CMAT	CND	DRT	DRWPWR	DRWSEC	DRWTK	EXBKL	EXBKR	EXL	EXR	FB	FD	FFDL	FPEB	FTK	FTKAV	FTKEV	ID	INFRM	LTI	MIP	P	PTOWB	RD	RECTKALL	RECTKBK	RECTKL	RECTKR	RT	SCPDRW	TD	TOTSSS	TVRAV	TVRFV	TVRVV	VTK	WLI			
•	•	•	•	•	•	•	•	•	•	•	•	•*	•	•	•	•	•	•	•	•	•	•	•	•	•	•	•	•	•	•	•	•	•	•	•	•	•	•	•	•	•	•	•	•	•	•

\*Not available on 15" wide

**Construction Upgrades**

APC	ET	PE
•	•	•

**Door Options**

CG	DPSRR
•	•

**BASE SINGLE DOOR with WOOD TIERED CUTLERY DIVIDER DRAWER and ROLL TRAYS**

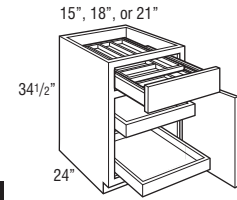

Model	1	2	3	4	5	6
<b>B15RTWTCD L or R</b>	1673	1703	1764	1805	1805	1805
<b>B18RTWTCD L or R</b>	1711	1746	1801	1846	1861	1868
<b>B21RTWTCD L or R</b>	1765	1804	1875	1920	1943	1953
<b>B24RTWTCD L or R</b>	1858	1900	1977	2022	2031	2037

- 2 roll trays standard.
- Cabinets may accommodate up to 4 roll trays, which may be purchased separately for field installation. See page 586.
- Exterior WTCD drawer box height is 3 3/4", interior height of top and bottom tier is 1 3/8".
- Wood Tiered Cutlery Divider Drawer is also available as an accessory. See page 580.

Model	7	8	9	10	11	12	13	14	15	16	17	18
<b>B15RTWTCD L or R</b>	1885	1849	1862	1897	1902	1918	1952	1956	1995	2019	2059	2101
<b>B18RTWTCD L or R</b>	1931	1915	1929	1965	1970	1990	2024	2028	2067	2096	2138	2182
<b>B21RTWTCD L or R</b>	2011	2006	2021	2060	2066	2085	2124	2132	2172	2200	2246	2295
<b>B24RTWTCD L or R</b>	2120	2091	2113	2153	2161	2180	2224	2228	2275	2307	2355	2409

**Custom Modifications**

AUTHL	AUTHR	CBO	CCO	CFNTO	CFP	CFRMO	CMAT	CND	DRT	DRWPWR	DRWSEC	DRWTK	EXBKL	EXBKR	EXL	EXR	FB	FFDL	FFDR	FPEB	FTK	FTKEV	ID	INVRM	LTI	MIP	P	PTOWB	RD	RECTKALL	RECTKBK	RECTKL	RECTKR	RT	SCPDWR	TD	TOTSSS	TVRAV	TVRFV	TVRVV	VTK	WLI			
•	•	•	•	•	•	•	•	•	•	•	•	•*	•	•	•	•	•	•	•	•	•	•	•	•	•	•	•	•	•	•	•	•	•	•	•	•	•	•	•	•	•	•	•	•	•

\*Not available on 15" wide

**Construction Upgrades**

APC	ET	PE
•	•	•

**Door Options**

CG	DPSRR
•	•

<b>B24RTWTCD</b>	2211	2164	2185	2227	2238	2260	2306	2310	2360	2394	2446	2503
<b>B30RTWTCD</b>	2536	2547	2570	2621	2630	2659	2713	2719	2778	2821	2882	2950
<b>B36RTWTCD</b>	2639	2676	2703	2755	2767	2797	2856	2862	2924	2969	3039	3110

**Custom Modifications**

AUTHL	AUTHR	CBO	CCO	CFNTO	CFP	CFRMO	CMAT	CND	DRT	DRWPWR	DRWSEC	DRWTK	EXBKL	EXBKR	EXL	EXR	FB	FFDL	FFDR	FPEB	FTK	FTKEV	ID	INVRM	LTI	MIP	P	PTOWB	RD	RECTKALL	RECTKBK	RECTKL	RECTKR	RT	SCPDWR	TD	TOTSSS	TVRAV	TVRFV	TVRVV	VTK	WLI			
•	•	•	•	•	•	•	•	•	•	•	•	•	•	•	•	•	•	•	•	•	•	•	•	•	•	•	•	•	•	•	•	•	•	•	•	•	•	•	•	•	•	•	•	•	•

**Construction Upgrades**

APC	ET	PE
•	•	•

**Door Options**

CG	DPSRR
•	•

**BASE DOUBLE DOOR with WOOD TIERED CUTLERY DIVIDER DRAWER and ROLL TRAYS**

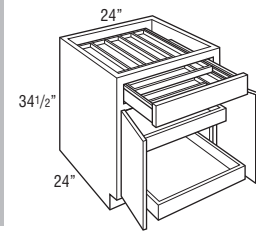

<b>B24RTWTCD</b>	1934	1976	2067	2106	2106	2106
<b>B30RTWTCD</b>	2184	2233	2348	2417	2438	2476
<b>B36RTWTCD</b>	2263	2316	2440	2513	2554	2601

- 2 roll trays standard.
- Cabinets may accommodate up to 4 roll trays, which may be purchased separately for field installation. See page 586.
- Exterior WTCD drawer box height is 3 3/4", interior height of top and bottom tier is 1 3/8".
- Wood Tiered Cutlery Divider Drawer is also available as an accessory. See page 580.

B24RTWTCD

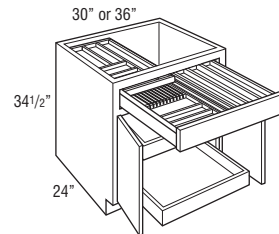

B30RTWTCD  
B36RTWTCD

**BASE with WOOD TIERED K-CUP\* DRAWER and ROLL TRAYS**

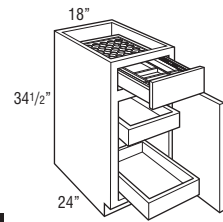

Model	1	2	3	4	5	6
<b>B18KUCPRT L or R</b>	1711	1746	1801	1846	1861	1868

- 2 roll trays standard.
  - Cabinets may accommodate up to 4 roll trays, which may be purchased separately for field installation. See page 586.
  - Exterior Wood Tiered K-Cup drawer box height is 3 3/4", interior height of top tier is 1 5/8", and interior height of bottom tier is 1 3/8".
  - The Wood Tiered K-Cup Drawer is compatible with K-Cup pods only.
  - Wood Tiered K-Cup Drawer is also available as an accessory. See page 581.
- \*K-Cup is a registered trademark of Keurig Green Mountain, Inc.

Model	7	8	9	10	11	12	13	14	15	16	17	18
<b>B18KUCPRT L or R</b>	1931	1915	1929	1965	1970	1990	2024	2028	2067	2096	2138	2182

**Custom Modifications**

AUTHL	AUTHR	CBO	CCO	CFNTO	CFP	CFRMO	CMAT	CND	DRT	DRWPWR	DRWSEC	DRWTK	EXBKL	EXBKR	EXL	EXR	FB	FD	FFDL	FPEB	FTK	FTKAV	FTKRV	ID	INVRM	LTI	MIP	P	PTOWB	RD	RECTKALL	RECTKLBK	RECTKL	RECTKR	RT	SCPRW	TD	TOTSSS	TVRAV	TVRFV	TVRVV	VTK	WLI		
•	•	•	•	•	•	•	•	•	•	•	•	•	•	•	•	•	•	•	•	•	•	•	•	•	•	•	•	•	•	•	•	•	•	•	•	•	•	•	•	•	•	•	•	•	•

**Construction Upgrades**

APC	ET	PE
•	•	•

**Door Options**

CG	DPSRR
•	•

<b>B30RTLO</b>	2034	2045	2068	2119	2128	2157	2211	2217	2276	2319	2380	2448
<b>B33RTLO</b>	2053	2091	2117	2169	2179	2209	2264	2271	2330	2374	2438	2506
<b>B36RTLO</b>	2101	2138	2165	2217	2229	2259	2318	2324	2386	2431	2501	2572

**Custom Modifications**

AUTHL	AUTHR	CBO	CCO	CFNTO	CFP	CFRMO	CMAT	CND	DRT	DRWPWR	DRWSEC	DRWTK	EXBKL	EXBKR	EXL	EXR	FB	FD	FFDL	FPEB	FTK	FTKAV	FTKRV	ID	INVRM	LTI	MIP	P	PTOWB	RD	RECTKALL	RECTKLBK	RECTKL	RECTKR	RT	SCPRW	TD	TOTSSS	TVRAV	TVRFV	TVRVV	VTK	WLI		
•	•	•	•	•	•	•	•	•	•	•	•	•	•	•	•	•	•	•	•	•	•	•	•	•	•	•	•	•	•	•	•	•	•	•	•	•	•	•	•	•	•	•	•	•	•

**Construction Upgrades**

APC	ET	PE
•	•	•

**Door Options**

CG	DPSRR
•	•

<b>B30FHRTLO</b>	1713	1825	1851	1894	1904	1931	1978	1983	2035	2069	2126	2183
<b>B33FHRTLO</b>	1729	1867	1894	1940	1948	1976	2026	2033	2088	2121	2182	2240
<b>B36FHRTLO</b>	1772	1907	1933	1980	1992	2016	2067	2071	2128	2169	2229	2291

**Custom Modifications**

AUTHL	AUTHR	CBO	CCO	CFNTO	CFP	CFRMO	CMAT	CND	DRT	DRWPWR	DRWSEC	DRWTK	EXBKL	EXBKR	EXL	EXR	FB	FD	FFDL	FPEB	FTK	FTKAV	FTKRV	ID	INVRM	LTI	MIP	P	PTOWB	RD	RECTKALL	RECTKLBK	RECTKL	RECTKR	RT	SCPRW	TD	TOTSSS	TVRAV	TVRFV	TVRVV	VTK	WLI		
•	•	•	•	•	•	•	•	•	•	•	•	•	•	•	•	•	•	•	•	•	•	•	•	•	•	•	•	•	•	•	•	•	•	•	•	•	•	•	•	•	•	•	•	•	•

**Construction Upgrades**

APC	ET	PE
•	•	•

**Door Options**

CG	DPSRR
•	•

<b>B24PS L or R</b>	1510	1481	1503	1543	1551	1570	1614	1618	1665	1697	1745	1799
<b>B24PS</b>	1601	1554	1575	1617	1628	1650	1696	1700	1750	1784	1836	1893
<b>B30PS</b>	1761	1772	1795	1846	1855	1884	1938	1944	2003	2046	2107	2175
<b>B36PS</b>	1916	1953	1980	2032	2044	2074	2133	2139	2201	2246	2316	2387

**Custom Modifications**

AUTHL	AUTHR	CBO	CCO	CFNTO	CFP	CFRMO	CMAT	CND	DRT	DRWPWR	DRWSEC	DRWTK	EXBKL	EXBKR	EXL	EXR	FB	FD	FFDL	FPEB	FTK	FTKAV	FTKRV	ID	INVRM	LTI	MIP	P	PTOWB	RD	RECTKALL	RECTKLBK	RECTKL	RECTKR	RT	SCPRW	TD	TOTSSS	TVRAV	TVRFV	TVRVV	VTK	WLI	
•	•	•	•	•	•	•	•	•	•	•	•*	•	•	•	•	•	•	•	•	•	•	•	•	•	•	•	•	•	•	•	•	•	•	•	•	•	•	•	•	•	•	•	•	•

\*Available only on 24" wide

**Construction Upgrades**

APC	ET	PE
•	•	•

**Door Options**

CG	DPSRR
•	•

**BASE with DRAWER and LID ORGANIZER and ROLL TRAYS**

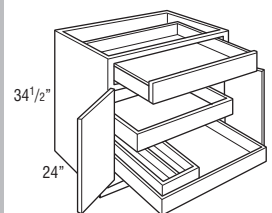

<b>B30RTLO</b>	1682	1731	1846	1915	1936	1974
<b>B33RTLO</b>	1704	1756	1861	1932	1975	2019
<b>B36RTLO</b>	1725	1778	1902	1975	2016	2063

- 2 roll trays standard.
- Cabinet has butt doors, no center stile.
- Pots and Pans Lid Organizer is also available as an accessory for field installation. See page 581.
- The lid organizer is attached to the roll tray with 2 screws for shipping purposes only. Screws should be removed during installation to make the lid organizer mobile.

**BASE with LID ORGANIZER and ROLL TRAYS**

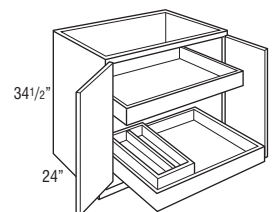

<b>B30FHRTLO</b>	1422	1468	1574	1626	1713	1763
<b>B33FHRTLO</b>	1436	1484	1587	1638	1750	1805
<b>B36FHRTLO</b>	1463	1510	1625	1679	1789	1843

- 2 roll trays standard.
- Cabinet has full height butt doors, no center stile.
- Cabinet may accommodate up to 5 roll trays, which may be purchased separately for field installation. See page 586.
- Pots and Pans Lid Organizer is also available as an accessory for field installation. See page 581.
- The lid organizer is attached to the roll tray with 2 screws for shipping purposes only. Screws should be removed during installation to make the lid organizer mobile.

**POTS & PANS ORGANIZER BASE with DRAWER**

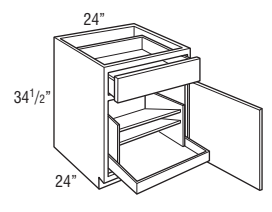

B24PS L or R

<b>B24PS L or R</b>	1248	1290	1367	1412	1421	1427
<b>B24PS</b>	1324	1366	1457	1496	1496	1496
<b>B30PS</b>	1409	1458	1573	1642	1663	1701
<b>B36PS</b>	1540	1593	1717	1790	1831	1878

- Cabinet has butt doors, no center stile.
- Cabinet has bottom roll tray with double lid storage shelves above.
- Base Pan Storage unit is also available as an accessory for field installation. See page 579.

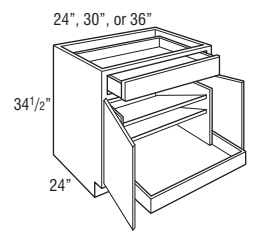

B24PS  
B30PS  
B36PS

**BASE POTS & PANS PULL-OUT**

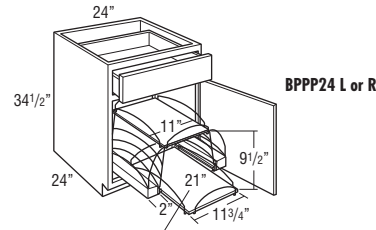

**BPPP24 L or R**

Shelf Depth (front to back)

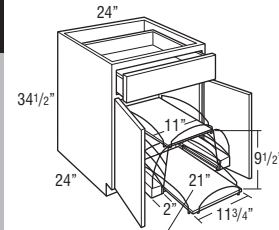

**BPPP24**

Shelf Depth (front to back)

Model	1	2	3	4	5	6
<b>BPPP24 L or R</b>	1433	1475	1552	1597	1606	1612
<b>BPPP24</b>	1509	1551	1642	1681	1681	1681

- Full Extension slide-out shelves pull out independently.
- Pots and Pans Pull-out is also available as an accessory for field installation. See page 582.
- For full access from both sides of unit, do not install against a wall or next to deeper appliances and cabinets.

**BASE POTS & PANS PULL-OUT**

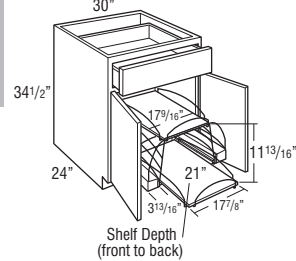

**BPPP30**

Shelf Depth (front to back)

<b>BPPP30</b>	1963	2012	2127	2196	2217	2255
---------------	------	------	------	------	------	------

- Full Extension slide-out shelves pull out independently.
- Pots and Pans Pull-out is also available as an accessory for field installation. See page 582.
- For full access from both sides of unit, do not install against a wall or next to deeper appliances and cabinets.

**BASE with FOOD STORAGE CONTAINER ORGANIZER**

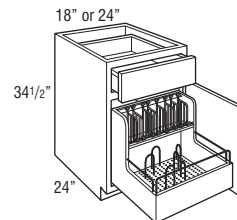

**B18FSCO L or R**

<b>B18FSCO L or R</b>	2019	2054	2109	2154	2169	2176
<b>B24FSCO L or R</b>	2132	2174	2251	2296	2305	2311

- Pull-out features natural finished hardwood dovetailed box with chrome rails on lower section with undermount Smart Stop guides.
- Includes seven chrome "U" pegs to use on the pegboard bottom to customize the fit to container sizes.
- Adjustable clip-on lid dividers included to fit with a variety of lid shapes. 18" wide includes five dividers, 24" wide includes eight dividers.
- Front of pull-out is routed for easy access.

Model	7	8	9	10	11	12	13	14	15	16	17	18
<b>BPPP24 L or R</b>	1695	1666	1688	1728	1736	1755	1799	1803	1850	1882	1930	1984
<b>BPPP24</b>	1786	1739	1760	1802	1813	1835	1881	1885	1935	1969	2021	2078

**Custom Modifications**

AUTHL	AUTHR	CBO	CCO	CFNTO	CFP	CFRMO	CMAT	CND	DRT	DRWPWR	DRWSEC	DRWTK	EXBKL	EXBKR	EXL	EXR	FB	FD	FFDL	FPEB	FTK	FTKAV	FTKRV	ID	INVFRM	LTI	MIP	P	PTOWB	RD	RECTKALL	RECTKLBK	RECTKL	RECTKR	RT	SCPRW	TD	TOTSSS	TVRAV	TVRFV	TVRVV	VTK	WLI			
•	•	•	•	•	•	•	•	•	•	•	•	•	•	•	•	•	•	•	•	•	•	•	•	•	•	•	•	•	•	•	•	•	•	•	•	•	•	•	•	•	•	•	•	•	•	•

**Construction Upgrades**

APC	ET	PE
•	•	•

**Door Options**

CG	DPSRR
•	•

<b>BPPP30</b>	2315	2326	2349	2400	2409	2438	2492	2498	2557	2600	2661	2729
---------------	------	------	------	------	------	------	------	------	------	------	------	------

**Custom Modifications**

AUTHL	AUTHR	CBO	CCO	CFNTO	CFP	CFRMO	CMAT	CND	DRT	DRWPWR	DRWSEC	DRWTK	EXBKL	EXBKR	EXL	EXR	FB	FD	FFDL	FPEB	FTK	FTKAV	FTKRV	ID	INVFRM	LTI	MIP	P	PTOWB	RD	RECTKALL	RECTKLBK	RECTKL	RECTKR	RT	SCPRW	TD	TOTSSS	TVRAV	TVRFV	TVRVV	VTK	WLI				
•	•	•	•	•	•	•	•	•	•	•	•	•	•	•	•	•	•	•	•	•	•	•	•	•	•	•	•	•	•	•	•	•	•	•	•	•	•	•	•	•	•	•	•	•	•	•	•

**Construction Upgrades**

APC	ET	PE
•	•	•

**Door Options**

CG	DPSRR
•	•

<b>B18FSCO L or R</b>	2239	2223	2237	2273	2278	2298	2332	2336	2375	2404	2446	2490
<b>B24FSCO L or R</b>	2394	2365	2387	2427	2435	2454	2498	2502	2549	2581	2629	2683

**Custom Modifications**

AUTHL	AUTHR	CBO	CCO	CFNTO	CFP	CFRMO	CMAT	CND	DRT	DRWPWR	DRWSEC	DRWTK	EXBKL	EXBKR	EXL	EXR	FB	FD	FFDL	FPEB	FTK	FTKAV	FTKRV	ID	INVFRM	LTI	MIP	P	PTOWB	RD	RECTKALL	RECTKLBK	RECTKL	RECTKR	RT	SCPRW	TD	TOTSSS	TVRAV	TVRFV	TVRVV	VTK	WLI				
•	•	•	•	•	•	•	•	•	•	•	•	•	•	•	•	•	•	•	•	•	•	•	•	•	•	•	•	•	•	•	•	•	•	•	•	•	•	•	•	•	•	•	•	•	•	•	•

**Construction Upgrades**

APC	ET	PE
•	•	•

**Door Options**

CG	DPSRR
•	•

**BASE with CAN and WINE BOTTLE PULL-OUTS**

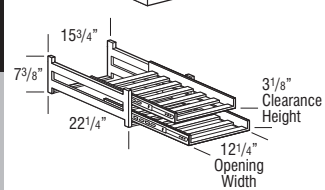
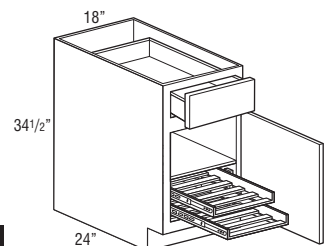

B18CWP12 L or R



Model	1	2	3	4	5	6
<b>B18CWP12 L or R</b>	2392	2427	2482	2527	2542	2549
<b>B18CWP18 L or R</b>	2885	2920	2975	3020	3035	3042
<b>B18CWP30 L or R</b>	3984	4019	4074	4119	4134	4141

- Pull-outs feature natural finished hardwood with side-mounted guides (Smart Stop not included).
- One adjustable full depth shelf on B18CWP12 and B18CWP18.
- B18CWP12 holds twelve wine bottles.  
B18CWP18 holds eighteen wine bottles.  
B18CWP30 holds thirty wine bottles.
- Insert not available as a field installed kit.

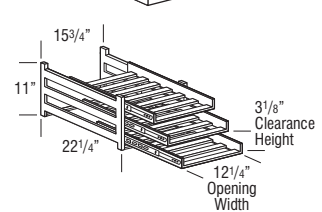
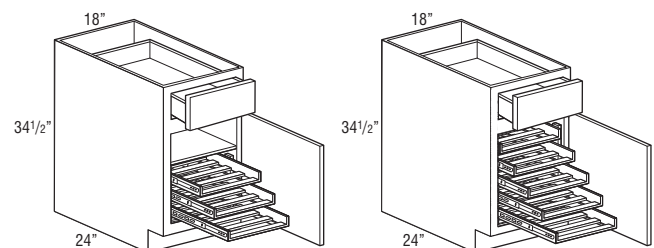

B18CWP18 L or R

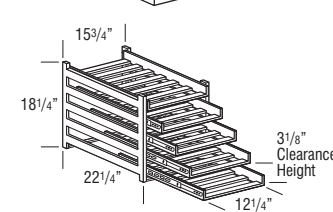
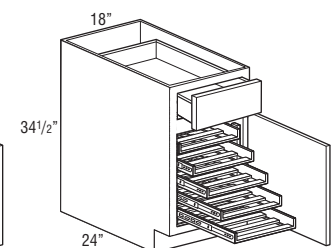

B18CWP30 L or R

**BASE FULL HEIGHT with CAN and WINE BOTTLE PULL-OUTS**

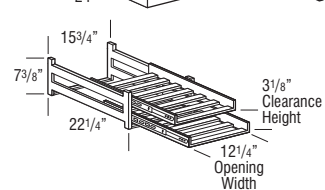
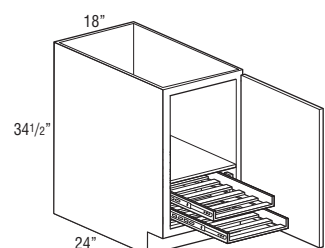

B18FHCWP12 L or R



Model	1	2	3	4	5	6
<b>B18FHCWP12 L or R</b>	2156	2187	2240	2273	2346	2380
<b>B18FHCWP18 L or R</b>	2649	2680	2733	2766	2839	2873
<b>B18FHCWP30 L or R</b>	3748	3779	3832	3865	3938	3972

- Pull-outs feature natural finished hardwood with side-mounted guides (Smart Stop not included).
- One adjustable full depth shelf.
- B18FHCWP12 holds twelve wine bottles.  
B18FHCWP18 holds eighteen wine bottles.  
B18FHCWP30 holds thirty wine bottles.
- Insert not available as a field installed kit.

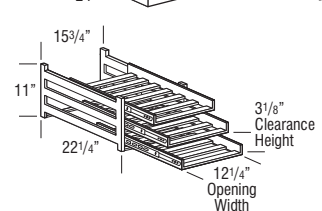
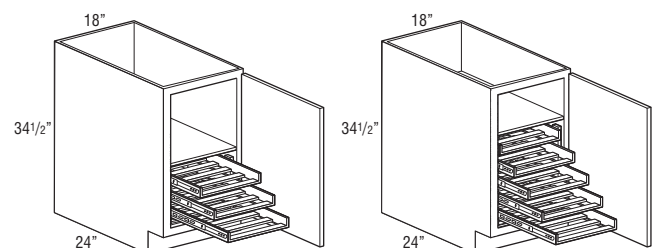

B18FHCWP18 L or R

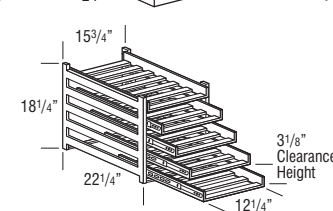
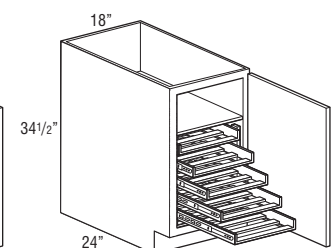

B18FHCWP30 L or R

Model	7	8	9	10	11	12	13	14	15	16	17	18
<b>B18CWP12 L or R</b>	2612	2596	2610	2646	2651	2671	2705	2709	2748	2777	2819	2863
<b>B18CWP18 L or R</b>	3105	3089	3103	3139	3144	3164	3198	3202	3241	3270	3312	3356
<b>B18CWP30 L or R</b>	4204	4188	4202	4238	4243	4263	4297	4301	4340	4369	4411	4455

**Custom Modifications**

AUTHL	AUTHR	CBO	CCO	CFNTD	CFP	CFRMO	CMAT	CND	DRT	DRWPWR	DRWSEC	DRWTK	EXBKL	EXBKR	EXL	EXR	FB	FD	FFDL	FFDR	FPEB	FTK	FTKAV	FTKRV	ID	INFRM	LTI	MIP	P	PTOWB	RD	RECTKALL	RECTKLBK	RECTKL	RECTKR	RT	SCDRW	TD	TOTSSS	TVRAV	TVRFV	TVRVV	VTK	WLI		
•	•	•	•	•	•	•	•	•	•	•	•	•	•	•	•	•	•	•	•	•	•	•	•	•	•	•	•	•	•	•	•	•	•	•	•	•	•	•	•	•	•	•	•	•	•	•

**Construction Upgrades**

APC	ET	PE
•	•	•

**Door Options**

CG	DPSRR
•	•

Model	1	2	3	4	5	6	7	8	9	10	11	12	13	14	15	16	17	18
<b>B18FHCWP12 L or R</b>	2331	2421	2437	2468	2472	2489	2519	2525	2560	2583	2620	2657						
<b>B18FHCWP18 L or R</b>	2824	2914	2930	2961	2965	2982	3012	3018	3053	3076	3113	3150						
<b>B18FHCWP30 L or R</b>	3923	4013	4029	4060	4064	4081	4111	4117	4152	4175	4212	4249						

**Custom Modifications**

AUTHL	AUTHR	CBO	CCO	CFNTD	CFP	CFRMO	CMAT	CND	DRT	DRWPWR	DRWSEC	DRWTK	EXBKL	EXBKR	EXL	EXR	FB	FD	FFDL	FFDR	FPEB	FTK	FTKAV	FTKRV	ID	INFRM	LTI	MIP	P	PTOWB	RD	RECTKALL	RECTKLBK	RECTKL	RECTKR	RT	SCDRW	TD	TOTSSS	TVRAV	TVRFV	TVRVV	VTK	WLI		
•	•	•	•	•	•	•	•	•	•	•	•	•	•	•	•	•	•	•	•	•	•	•	•	•	•	•	•	•	•	•	•	•	•	•	•	•	•	•	•	•	•	•	•	•	•	•

**Construction Upgrades**

APC	ET	PE
•	•	•

**Door Options**

CG	DPSRR
•	•



**BASE with ROLL-OUT TRAY DIVIDER**

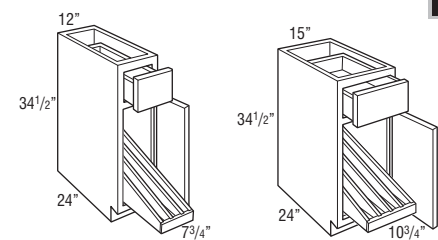

**B12TDRO L or R**      **B15TDRO L or R**

Model	1	2	3	4	5	6
<b>B12TDRO L or R</b>	1015	1045	1098	1135	1144	1144
<b>B15TDRO L or R</b>	1082	1112	1173	1214	1214	1214

- Dividers are removable.
- 12" - 3 compartments.
- 15" - 4 compartments.
- Roll-out Tray Divider is also available as an accessory for field installation. See page 584.
- Tray divider utilizes Smart Stop undermount guides and bumpers for door protection.

**BASE with TRAY DIVIDER**

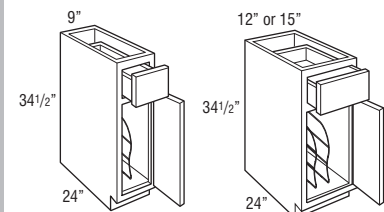

**TD9 L or R**      **TD12 L or R**  
**TD15 L or R**

<b>TD9 L or R</b>	688	721	782	809	809	809
<b>TD12 L or R</b>	724	759	831	857	853	857
<b>TD15 L or R</b>	758	795	879	907	894	907

- Tray Divider is chrome.
- Tray Divider is also available as an accessory for field installation. See page 584.

**BASE FULL HEIGHT with TRAY DIVIDER**

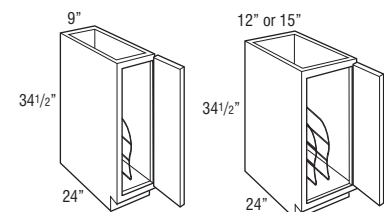

**TD9FH L or R**      **TD12FH L or R**  
**TD15FH L or R**

<b>TD9FH L or R</b>	555	587	646	675	675	675
<b>TD12FH L or R</b>	588	625	697	724	718	724
<b>TD15FH L or R</b>	624	663	745	771	762	771

- Tray Divider is chrome.
- Tray Divider is also available as an accessory for field installation. See page 584.

**BASE CABINET with MIXER SHELF**

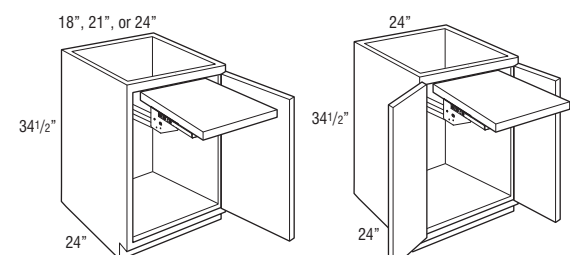

**B18FHMIXSC L or R**  
**B21FHMIXSC L or R**  
**B24FHMIXSC L or R**      **B24FHMIXSC**

<b>B18FHMIXSC L or R</b>	1570	1601	1654	1687	1760	1794
<b>B21FHMIXSC L or R</b>	1723	1754	1823	1860	1938	1975
<b>B24FHMIXSC L or R</b>	1960	1998	2083	2127	2211	2177

<b>B24FHMIXSC</b>	1993	2031	2123	2167	2257	2221
-------------------	------	------	------	------	------	------

- Includes mixer lift with Smart Stop closing feature.
- Mixer shelf will be 3/4" thick natural finished veneer plywood, mixer shelf dimensions:  
18" wide: 11 3/4" wide x 20" deep.  
21" wide: 14 3/4" wide x 20" deep.  
24" wide: 17 3/4" wide x 20" deep.
- Maximum Weight Capacity for Mixer Shelf: 60 lbs.
- Mixer shelf locks in the fully open position. Release brackets lower the mixer shelf back into the cabinet.
- When in closed position, clearance above shelf is 17 5/8"; clearance below shelf is 7 3/4".

Model	7	8	9	10	11	12	13	14	15	16	17	18
<b>B12TDRO L or R</b>	1211	1184	1200	1230	1235	1250	1283	1288	1324	1349	1383	1424
<b>B15TDRO L or R</b>	1294	1258	1271	1306	1311	1327	1361	1365	1404	1428	1468	1510

**Custom Modifications**

AUTHL	AUTHR	CBO	CCO	CFNTO	CFP	CFRMO	CMAT	CND	DRT	DRWPWR	DRWSEC	DRWTK	EXBKL	EXBKR	EXL	EXR	FB	FD	FFDL	FPEB	FTK	FTKAV	FTKRV	ID	INVFRM	LTI	MIP	P	PTOWB	RD	RECTKALL	RECTKLBK	RECTKL	RECTKR	RT	SCPRDR	TD	TOTSSS	TVRAV	TVRFV	TVRVV	VTK	WLI	
•	•	•	•	•	•	•	•	•	•	•	•	•	•	•	•	•	•	•	•	•	•	•*	•	•	•	•	•	•	•	•	•	•	•	•	•	•	•	•	•	•	•	•	•	•

\*Not available on 12" wide

**Construction Upgrades**

APC	ET	PE
•	•	•

**Door Options**

CG	DPSRR
•	•

<b>TD9 L or R</b>	886	853	868	897	908	921	958	961	995	1020	1059	1101
<b>TD12 L or R</b>	940	906	919	956	961	979	1014	1018	1057	1085	1125	1170
<b>TD15 L or R</b>	994	956	968	1005	1013	1032	1068	1074	1114	1141	1184	1231

**Custom Modifications**

AUTHL	AUTHR	CBO	CCO	CFNTO	CFP	CFRMO	CMAT	CND	DRT	DRWPWR	DRWSEC	DRWTK	EXBKL	EXBKR	EXL	EXR	FB	FD	FFDL	FPEB	FTK	FTKAV	FTKRV	ID	INVFRM	LTI	MIP	P	PTOWB	RD	RECTKALL	RECTKLBK	RECTKL	RECTKR	RT	SCPRDR	TD	TOTSSS	TVRAV	TVRFV	TVRVV	VTK	WLI		
•	•	•	•	•	•	•	•	•	•	•	•	•	•	•	•	•	•	•	•	•	•	•	•*	•	•	•	•	•	•	•	•	•	•	•	•	•	•	•	•	•	•	•	•	•	•

\*Not available on 9" and 12" wide

\*Not available on 9" wide

**Construction Upgrades**

APC	ET	PE
•	•	•

**Door Options**

CG	DPSRR
•†	•

†Not available on 9" wide

<b>TD9FH L or R</b>	755	718	734	764	772	787	822	826	864	885	925	968
<b>TD12FH L or R</b>	809	769	785	820	826	843	879	883	923	951	991	1037
<b>TD15FH L or R</b>	863	820	834	870	878	897	932	938	980	1009	1050	1098

**Custom Modifications**

AUTHL	AUTHR	CBO	CCO	CFNTO	CFP	CFRMO	CMAT	CND	DRT	DRWPWR	DRWSEC	DRWTK	EXBKL	EXBKR	EXL	EXR	FB	FD	FFDL	FPEB	FTK	FTKAV	FTKRV	ID	INVFRM	LTI	MIP	P	PTOWB	RD	RECTKALL	RECTKLBK	RECTKL	RECTKR	RT	SCPRDR	TD	TOTSSS	TVRAV	TVRFV	TVRVV	VTK	WLI		
•	•	•	•	•	•	•	•	•	•	•	•	•	•	•	•	•	•	•	•	•	•	•	•*	•	•	•	•	•	•	•	•	•	•	•	•	•	•	•	•	•	•	•	•	•	•

\*Not available on 9" and 12" wide

\*Not available on 9" wide

**Construction Upgrades**

APC	ET	PE
•	•	•

**Door Options**

CG	DPSRR
•†	•

†Not available on 9" wide

<b>B18FHMIXSC L or R</b>	1745	1835	1851	1882	1886	1903	1933	1939	1974	1997	2034	2071
<b>B21FHMIXSC L or R</b>	1926	2018	2034	2064	2075	2091	2128	2131	2169	2194	2235	2273
<b>B24FHMIXSC L or R</b>	2207	2227	2248	2280	2290	2308	2349	2350	2392	2423	2467	2512

<b>B24FHMIXSC</b>	2252	2274	2293	2331	2339	2359	2400	2402	2446	2479	2526	2572
-------------------	------	------	------	------	------	------	------	------	------	------	------	------

**Custom Modifications**

AUTHL	AUTHR	CBO	CCO	CFNTO	CFP	CFRMO	CMAT	CND	DRT	DRWPWR	DRWSEC	DRWTK	EXBKL	EXBKR	EXL	EXR	FB	FD	FFDL	FPEB	FTK	FTKAV	FTKRV	ID	INVFRM	LTI	MIP	P	PTOWB	RD	RECTKALL	RECTKLBK	RECTKL	RECTKR	RT	SCPRDR	TD	TOTSSS	TVRAV	TVRFV	TVRVV	VTK	WLI		
•	•	•	•	•	•	•	•	•	•	•	•	•	•	•	•	•	•	•	•	•	•	•	•	•	•	•	•	•	•	•	•	•	•	•	•	•	•	•	•	•	•	•	•	•	•

**Construction Upgrades**

APC	ET	PE
•	•	•

**Door Options**

CG	DPSRR
•	•



**SINK BASE, 27" DEEP, SINGLE or DOUBLE DOOR**

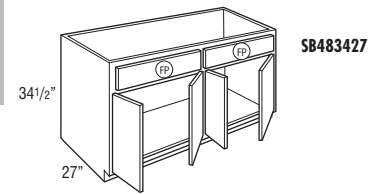
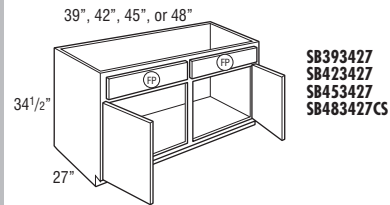
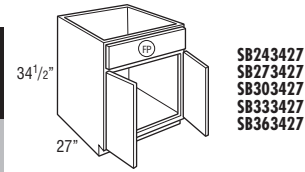
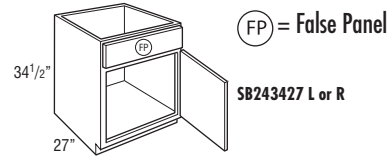

Model	1	2	3	4	5	6
<b>SB243427 L or R</b>	598	649	693	757	883	871
<b>SB243427</b>	629	682	730	795	930	918
<b>SB273427</b>	651	696	773	828	936	988
<b>SB303427</b>	699	743	840	905	1001	1052
<b>SB333427</b>	718	765	863	923	1041	1095
<b>SB363427</b>	738	787	886	954	1078	1135
<b>SB393427</b>	785	833	938	1010	1138	1197
<b>SB423427</b>	804	861	999	1072	1211	1270
<b>SB453427</b>	855	914	1057	1133	1283	1333
<b>SB483427CS</b>	907	968	1114	1194	1354	1395
<b>SB483427</b>	1008	1077	1226	1314	1499	1519

• Mini Touch-up Kit (MTUK) included. MTUK includes small touch-up marker and small fill stick.

Model	7	8	9	10	11	12	13	14	15	16	17	18
<b>SB243427 L or R</b>	833	924	940	980	988	1008	1049	1051	1097	1128	1174	1222
<b>SB243427</b>	877	972	991	1031	1040	1060	1103	1110	1155	1187	1237	1287
<b>SB273427</b>	912	1048	1068	1111	1123	1141	1188	1194	1245	1277	1331	1385
<b>SB303427</b>	992	1115	1137	1183	1195	1218	1267	1273	1327	1362	1419	1475
<b>SB333427</b>	1016	1162	1183	1231	1243	1267	1317	1324	1378	1419	1477	1538
<b>SB363427</b>	1047	1203	1226	1277	1287	1314	1367	1374	1430	1469	1530	1593
<b>SB393427</b>	1112	1267	1292	1344	1356	1385	1439	1446	1505	1549	1613	1679
<b>SB423427</b>	1176	1346	1374	1429	1442	1472	1529	1537	1599	1644	1712	1782
<b>SB453427</b>	1246	1414	1442	1500	1513	1544	1604	1610	1678	1723	1798	1869
<b>SB483427CS</b>	1312	1479	1508	1568	1583	1616	1680	1686	1755	1804	1882	1956
<b>SB483427</b>	1446	1610	1641	1708	1725	1755	1831	1838	1913	1965	2048	2130

**Custom Modifications**

AUTHL	AUTHR	CBO	CCO	CFNTO	CFP	CFRMO	CMAT	CND	DRT	DRWPWR	DRWSEC	DRWTK	EXBKL	EXBKR	EXL	EXR	FB	FD	FFDL	FFDR	FPFB	FTK	FTKAV	FTKEV	ID	INVRM	LTI	MIP	P	PTOWB	RD	RECTKALL	RECTKBK	RECTKL	RECTKR	RT	SCPDRW	TD	TOTSSS	TVRAV	TVRFV	TVRVV	VTK	WLU
•		•	•		•	•	•	•					•	•	•						•	•	•				•	•	•				•	•				•	•	•	•	•		

**Construction Upgrades**

APC	ET	PE
•		•

**Door Options**

CG	DPSRR
•	•





**SINK BASE SUPERCABINET™**

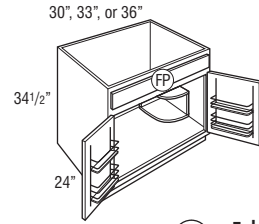

FP = False Panel

Model	1	2	3	4	5	6
<b>SB30S</b>	1036	1080	1174	1234	1330	1378
<b>SB33S</b>	1059	1104	1193	1251	1364	1415
<b>SB36S</b>	1076	1123	1220	1281	1399	1455

- Quarter Round Reversible Shelf for left or right applications will be constructed from 3/4" thick laminated furniture board. When upgraded to APC, shelf will use clear coated veneer plywood. (Shelf shipped secure, can be positioned in left or right corner.)
- Mini Touch-up Kit (MTUK) included. MTUK includes small touch-up marker and small fill stick.
- All load bearing surfaces meet KCMA standards of 15 lbs. per square foot.
- Each door features a chrome and wood two-tiered rack.
- Door rack width is 11 3/8" on 30" and 33" wide cabinets and 14 3/8" on 36" wide cabinet.
- Door rack depth is 3 1/2".

**SINK BASE SUPERCABINET™ with CABMAT™**

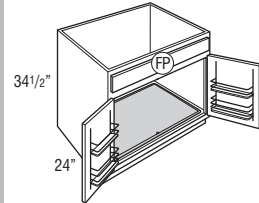

<b>SB30SCM</b>	1263	1307	1401	1461	1557	1605
<b>SB33SCM</b>	1286	1331	1420	1478	1591	1642
<b>SB36SCM</b>	1303	1350	1447	1508	1626	1682

- Mini Touch-up Kit (MTUK) included. MTUK includes small touch-up marker and small fill stick.
- CabMat™ is designed to capture spills and is removable for cleaning.
- All load bearing surfaces meet KCMA standards of 15 lbs. per square foot.
- Each door features a chrome and wood two-tiered rack.
- Door rack width is 11 3/8" on 30" and 33" wide cabinets and 14 3/8" on 36" wide cabinet.
- Door rack depth is 3 1/2".

Model	Liquid Capacity		Cabinet Size	
	Gallons	Liters	Width	Depth
SB30SCM	2.0	7.6	30"	24"
SB33SCM	2.4	9.0	33"	24"
SB36SCM	2.7	10.2	36"	24"

**SINK BASE SUPERCABINET™ with CADDY**

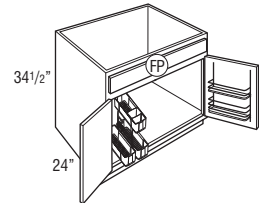

<b>SB36SCDY L or R</b>	1530	1577	1674	1735	1853	1909
------------------------	------	------	------	------	------	------

- Mini Touch-up Kit (MTUK) included. MTUK includes small touch-up marker and small fill stick.
- L or R designates caddy location.
- Caddy is removable and portable.
- Caddy dimensions are: 9 15/16" wide x 18 5/16" tall x 18 5/8" deep.
- Door opposite caddy features a chrome and wood two-tiered rack.
- Door rack width is 14 3/8".
- Door rack depth is 3 1/2".

**SINK BASE SUPERCABINET™ with TILT-OUT TRAYS**

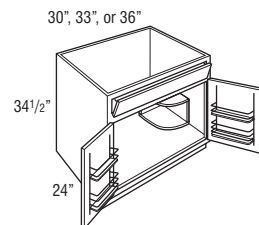

<b>SB30STS</b>	1243	1300	1379	1451	1538	1591
<b>SB33STS</b>	1267	1329	1403	1476	1568	1627
<b>SB36STS</b>	1287	1348	1426	1504	1605	1664

- Quarter Round Reversible Shelf for left or right applications will be constructed from 3/4" thick laminated furniture board. When upgraded to APC, shelf will use clear coated veneer plywood. (Shelf shipped secure, can be positioned in left or right corner.)
- Mini Touch-up Kit (MTUK) included. MTUK includes small touch-up marker and small fill stick.
- Includes two tilt-out trays.
- Tilt-out trays are stain resistant, moisture resistant plastic to allow storage of sponges and other cleaning materials.
- Tilt-out trays are also available as an accessory for field installation. See page 584.
- All load bearing surfaces meet KCMA standards of 15 lbs. per square foot.
- Each door features a chrome and wood two-tiered rack.
- Door rack width is 11 3/8" on 30" and 33" wide cabinets and 14 3/8" on 36" wide cabinet.
- Door rack depth is 3 1/2".

Model	7	8	9	10	11	12	13	14	15	16	17	18
<b>SB30S</b>	1317	1436	1458	1503	1510	1534	1578	1586	1636	1670	1722	1776
<b>SB33S</b>	1339	1476	1503	1546	1556	1582	1629	1635	1687	1721	1778	1835
<b>SB36S</b>	1369	1517	1541	1589	1598	1626	1675	1679	1735	1770	1830	1888

**Custom Modifications**

AUTHL	AUTHR	CBO	CCO	CFNTO	CFP	CFRMO	CMAT	CND	DRT	DRWPWR	DRWSEC	DRWTK	EXBKL	EXBKR	EXL	EXR	FB	FFDL	FFDR	FPEB	FTK	FTKAV	FTKEV	ID	INVFRM	LTI	MIP	P	PTOWB	RD	RECTKALL	RECTKBK	RECTKL	RECTKR	RT	SCPRDW	TD	TOTSSS	TVRAV	TVRFV	TVRVV	VTK	WLU			
•	•	•	•	•	•	•	•	•	•	•	•	•	•	•	•	•	•	•	•	•	•	•	•	•	•	•	•	•	•	•	•	•	•	•	•	•	•	•	•	•	•	•	•	•	•	•

**Construction Upgrades**

APC	ET	PE
•	•	•

**Door Options**

CG	DPSRR
•	•

<b>SB30SCM</b>	1544	1663	1685	1730	1737	1761	1805	1813	1863	1897	1949	2003
<b>SB33SCM</b>	1566	1703	1730	1773	1783	1809	1856	1862	1914	1948	2005	2062
<b>SB36SCM</b>	1596	1744	1768	1816	1825	1853	1902	1906	1962	1997	2057	2115

**Custom Modifications**

AUTHL	AUTHR	CBO	CCO	CFNTO	CFP	CFRMO	CMAT	CND	DRT	DRWPWR	DRWSEC	DRWTK	EXBKL	EXBKR	EXL	EXR	FB	FFDL	FFDR	FPEB	FTK	FTKAV	FTKEV	ID	INVFRM	LTI	MIP	P	PTOWB	RD	RECTKALL	RECTKBK	RECTKL	RECTKR	RT	SCPRDW	TD	TOTSSS	TVRAV	TVRFV	TVRVV	VTK	WLU						
•	•	•	•	•	•	•	•	•	•	•	•	•	•	•	•	•	•	•	•	•	•	•	•	•	•	•	•	•	•	•	•	•	•	•	•	•	•	•	•	•	•	•	•	•	•	•	•	•	•

**Construction Upgrades**

APC	ET	PE
•	•	•

**Door Options**

CG	DPSRR
•	•

<b>SB36SCDY L or R</b>	1823	1971	1995	2043	2052	2080	2129	2133	2189	2224	2284	2342
------------------------	------	------	------	------	------	------	------	------	------	------	------	------

**Custom Modifications**

AUTHL	AUTHR	CBO	CCO	CFNTO	CFP	CFRMO	CMAT	CND	DRT	DRWPWR	DRWSEC	DRWTK	EXBKL	EXBKR	EXL	EXR	FB	FFDL	FFDR	FPEB	FTK	FTKAV	FTKEV	ID	INVFRM	LTI	MIP	P	PTOWB	RD	RECTKALL	RECTKBK	RECTKL	RECTKR	RT	SCPRDW	TD	TOTSSS	TVRAV	TVRFV	TVRVV	VTK	WLU						
•	•	•	•	•	•	•	•	•	•	•	•	•	•	•	•	•	•	•	•	•	•	•	•	•	•	•	•	•	•	•	•	•	•	•	•	•	•	•	•	•	•	•	•	•	•	•	•	•	•

**Construction Upgrades**

APC	ET	PE
•	•	•

**Door Options**

CG	DPSRR
•	•

<b>SB30STS</b>	1559	1663	1690	1744	1754	1780	1837	1848	1910	1948	2013	2078
<b>SB33STS</b>	1589	1702	1727	1780	1796	1822	1881	1888	1951	1997	2064	2130
<b>SB36STS</b>	1618	1744	1770	1825	1838	1868	1927	1936	2001	2048	2117	2184

**Custom Modifications**

AUTHL	AUTHR	CBO	CCO	CFNTO	CFP	CFRMO	CMAT	CND	DRT	DRWPWR	DRWSEC	DRWTK	EXBKL	EXBKR	EXL	EXR	FB	FFDL	FFDR	FPEB	FTK	FTKAV	FTKEV	ID	INVFRM	LTI	MIP	P	PTOWB	RD	RECTKALL	RECTKBK	RECTKL	RECTKR	RT	SCPRDW	TD	TOTSSS	TVRAV	TVRFV	TVRVV	VTK	WLU					
•	•	•	•	•	•	•	•	•	•	•	•	•	•	•	•	•	•	•	•	•	•	•	•	•	•	•	•	•	•	•	•	•	•	•	•	•	•	•	•	•	•	•	•	•	•	•	•	•

**Construction Upgrades**

APC	ET	PE
•	•	•

**Door Options**

CG	DPSRR
•	•

**SINK BASE SUPERCABINET™ with TILT-OUT TRAYS and CABMAT™**

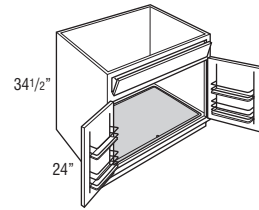

Model	1	2	3	4	5	6
<b>SB30STSCM</b>	1470	1527	1606	1678	1765	1818
<b>SB33STSCM</b>	1494	1556	1630	1703	1795	1854
<b>SB36STSCM</b>	1514	1575	1653	1731	1832	1891

- Mini Touch-up Kit (MTUK) included. MTUK includes small touch-up marker and small fill stick.
- CabMat™ is designed to capture spills and is removable for cleaning.
- Includes two tilt-out trays.
- Tilt-out trays are stain resistant, moisture resistant plastic to allow storage of sponges and other cleaning materials.
- Tilt-out trays are also available as an accessory for field installation. See page 584.
- All load bearing surfaces meet KCMA standards of 15 lbs. per square foot.
- Each door features a chrome and wood two-tiered rack.
- Door rack width is 11 3/8" on 30" and 33" wide cabinets and 14 3/8" on 36" wide cabinet.
- Door rack depth is 3 1/2".

Model	Liquid Capacity		Cabinet Size	
	Gallons	Liters	Width	Depth
SB30STSCM	2.0	7.6	30"	24"
SB33STSCM	2.4	9.0	33"	24"
SB36STSCM	2.7	10.2	36"	24"

**SINK BASE SUPERCABINET™ with TILT-OUT TRAYS and CADDY**

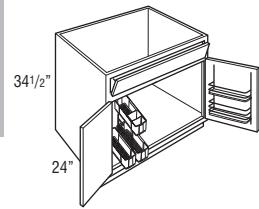

<b>SB36STSCDY L or R</b>	1741	1802	1880	1958	2059	2118
--------------------------	------	------	------	------	------	------

- Mini Touch-up Kit (MTUK) included. MTUK includes small touch-up marker and small fill stick.
- L or R designates caddy location.
- Caddy is removable and portable.
- Includes two tilt-out trays.
- Tilt-out trays are stain resistant, moisture resistant plastic to allow storage of sponges and other cleaning materials.
- Tilt-out trays are also available as an accessory for field installation. See page 584.
- Caddy dimensions are: 9 15/16" wide x 18 5/16" tall x 18 5/8" deep.
- Door opposite caddy features a chrome and wood two-tiered rack.
- Door rack width is 14 3/8".
- Door rack depth is 3 1/2".

**SINK BASE with DRAWER BELOW**

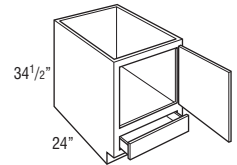

SB24D L or R

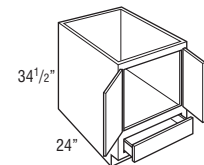

SB24D  
SB27D  
SB30D  
SB33D  
SB36D

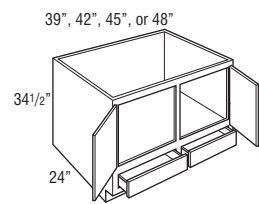

SB39D  
SB42D  
SB45D  
SB48DCS

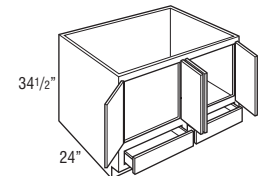

SB48D

<b>SB24D L or R</b>	1053	1053	1053	1053	1053	1053
<b>SB24D</b>	1112	1112	1112	1112	1112	1112
<b>SB27D</b>	1214	1226	1245	1250	1214	1250
<b>SB30D</b>	1269	1283	1298	1309	1267	1309
<b>SB33D</b>	1306	1322	1335	1348	1304	1350
<b>SB36D</b>	1339	1361	1374	1385	1351	1404
<b>SB39D</b>	1565	1565	1565	1565	1565	1565
<b>SB42D</b>	1644	1644	1644	1644	1644	1644
<b>SB45D</b>	1703	1710	1715	1720	1710	1721
<b>SB48DCS</b>	1760	1777	1786	1798	1776	1800
<b>SB48D</b>	1877	1909	1927	1951	1907	1955

- Drawers are below full cabinet floor.
- Mini Touch-up Kit (MTUK) included. MTUK includes small touch-up marker and small fill stick.
- Verify that sink, garbage disposal and plumbing fit opening.
- Plumbing going through floor will interfere with drawer operation. 2 3/4" clearance from back of drawer to interior back of cabinet.
- Face frame opening height is 20 1/2".
- Face frame opening height for drawer is 4 1/2".

Model	7	8	9	10	11	12	13	14	15	16	17	18
<b>SB30STSCM</b>	1786	1890	1917	1971	1981	2007	2064	2075	2137	2175	2240	2305
<b>SB33STSCM</b>	1816	1929	1954	2007	2023	2049	2108	2115	2178	2224	2291	2357
<b>SB36STSCM</b>	1845	1971	1997	2052	2065	2095	2154	2163	2228	2275	2344	2411

**Custom Modifications**

AUTHL	AUTHR	CBO	CCO	CFNTO	CFP	CFRMO	CMAT	CND	DRT	DRWPWR	DRWSEC	DRWTK	EXBKL	EXBKR	EXL	EXR	FB	FFDL	FFDR	EPFB	FTK	FTKAV	FTKFV	ID	INVFRM	LTI	MIP	P	PTOWB	RD	RECTKALL	RECTKLBK	RECTKL	RECTKR	RT	SCPDRW	TD	TOTSSS	TVRAV	TVRFV	TVRVV	VTK	WLI			
•	•	•	•	•	•	•	•	•	•	•	•	•	•	•	•	•	•	•	•	•	•	•	•	•	•	•	•	•	•	•	•	•	•	•	•	•	•	•	•	•	•	•	•	•	•	•

**Construction Upgrades**

APC	ET	PE
•	•	•

**Door Options**

CG	DPSRR
•	•

<b>SB36STSCDY L or R</b>	2072	2198	2224	2279	2292	2322	2381	2390	2455	2502	2571	2638
--------------------------	------	------	------	------	------	------	------	------	------	------	------	------

**Custom Modifications**

AUTHL	AUTHR	CBO	CCO	CFNTO	CFP	CFRMO	CMAT	CND	DRT	DRWPWR	DRWSEC	DRWTK	EXBKL	EXBKR	EXL	EXR	FB	FFDL	FFDR	EPFB	FTK	FTKAV	FTKFV	ID	INVFRM	LTI	MIP	P	PTOWB	RD	RECTKALL	RECTKLBK	RECTKL	RECTKR	RT	SCPDRW	TD	TOTSSS	TVRAV	TVRFV	TVRVV	VTK	WLI				
•	•	•	•	•	•	•	•	•	•	•	•	•	•	•	•	•	•	•	•	•	•	•	•	•	•	•	•	•	•	•	•	•	•	•	•	•	•	•	•	•	•	•	•	•	•	•	•

**Construction Upgrades**

APC	ET	PE
•	•	•

**Door Options**

CG	DPSRR
•	•

<b>SB24D L or R</b>	1162	1116	1135	1176	1187	1212	1254	1260	1308	1342	1394	1449
<b>SB24D</b>	1221	1173	1195	1241	1250	1273	1320	1327	1377	1413	1467	1524
<b>SB27D</b>	1375	1319	1345	1396	1405	1431	1488	1494	1552	1593	1655	1720
<b>SB30D</b>	1441	1384	1408	1462	1476	1502	1559	1565	1627	1670	1738	1806
<b>SB33D</b>	1484	1427	1453	1506	1521	1550	1607	1613	1679	1724	1792	1861
<b>SB36D</b>	1522	1484	1511	1567	1581	1609	1674	1682	1747	1791	1860	1936
<b>SB39D</b>	1722	1650	1680	1741	1752	1784	1849	1856	1926	1975	2051	2132
<b>SB42D</b>	1807	1732	1761	1829	1840	1874	1944	1951	2025	2075	2153	2241
<b>SB45D</b>	1893	1813	1846	1915	1930	1964	2038	2045	2123	2176	2259	2351
<b>SB48DCS</b>	1977	1897	1930	2003	2019	2055	2131	2139	2219	2276	2364	2461
<b>SB48D</b>	2144	2061	2099	2178	2196	2234	2317	2327	2416	2478	2575	2677

**Custom Modifications**

AUTHL	AUTHR	CBO	CCO	CFNTO	CFP	CFRMO	CMAT	CND	DRT	DRWPWR	DRWSEC	DRWTK	EXBKL	EXBKR	EXL	EXR	FB	FFDL	FFDR	EPFB	FTK	FTKAV	FTKFV	ID	INVFRM	LTI	MIP	P	PTOWB	RD	RECTKALL	RECTKLBK	RECTKL	RECTKR	RT	SCPDRW	TD	TOTSSS	TVRAV	TVRFV	TVRVV	VTK	WLI		
•	•	•	•	•	•	•	•*	•	•	•	•	•*	•	•	•	•	•	•	•	•	•	•	•	•	•	•	•	•	•	•	•	•	•	•	•	•	•	•	•	•	•	•	•	•	•

\*Available only on 30", 33", and 36" wide \*Not available on 39", 42", 45", and 48" wide

**Construction Upgrades**

APC	ET	PE
•	•	•

**Door Options**

CG	DPSRR
•	•







**COUNTRY SINK BASE with CABMAT™**

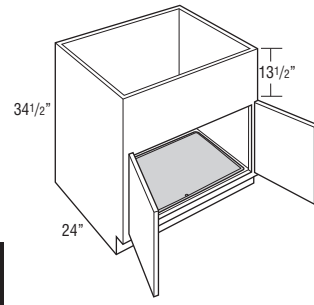

Model	1	2	3	4	5	6
<b>CNTYSB30CM</b>	890	934	1028	1088	1184	1232
<b>CNTYSB33CM</b>	911	956	1051	1108	1217	1269
<b>CNTYSB36CM</b>	930	977	1074	1135	1253	1309

- Mini Touch-up Kit (MTUK) included. MTUK includes small touch-up marker and small fill stick.
- CabMat™ is designed to capture spills and is removable for cleaning.
- 13 1/2" panel can be trimmed to 12".
- For apron front sinks requiring smaller cut-out heights, see Country Sink Base with Short Apron on page 288 or Base Drop-in Range Cabinets on page 328.
- Refer to sink manufacturer's recommendations for additional support required for apron front sinks.

Model	Liquid Capacity		Cabinet Size	
	Gallons	Liters	Width	Depth
CNTYSB30CM	2.0	7.6	30"	24"
CNTYSB33CM	2.4	9.0	33"	24"
CNTYSB36CM	2.7	10.2	36"	24"

**COUNTRY SINK BASE with SHORT APRON**

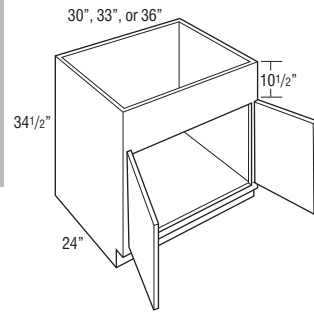

<b>CNTYSB30SA</b>	663	707	801	861	957	1005
<b>CNTYSB33SA</b>	684	729	824	881	990	1042
<b>CNTYSB36SA</b>	703	750	847	908	1026	1082
<b>CNTYSB39SA</b>	762	813	919	984	1102	1163

- 10 1/2" panel can be trimmed up to 9".
- Mini Touch-up Kit (MTUK) included. MTUK includes small touch-up marker and small fill stick.
- For apron front sinks requiring a cut-out height of 6 1/2" or less, see Base Drop-in Range Cabinets on page 328.
- Refer to sink manufacturer's recommendations for additional support required for apron front sinks.

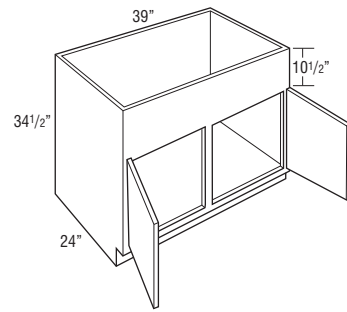

Model	7	8	9	10	11	12	13	14	15	16	17	18
<b>CNTYSB30CM</b>	1171	1290	1312	1357	1364	1388	1432	1440	1490	1524	1576	1630
<b>CNTYSB33CM</b>	1197	1330	1355	1399	1409	1432	1482	1487	1540	1574	1630	1686
<b>CNTYSB36CM</b>	1223	1371	1395	1443	1452	1480	1529	1533	1589	1624	1684	1742

**Custom Modifications**

AUTHL	AUTHR	CBO	CCO	CFNTO	CFP	CFRMO	CMAT	CND	DRT	DRWPWR	DRWSEC	DRWTK	EXBKL	EXBKR	EXL	EXR	FB	FFDL	FPEB	FTK	FTKAV	FTKFV	ID	INVFRM	LTI	MIP	P	PTOWB	RD	RECTKALL	RECTKBK	RECTKL	RECTKR	RT	SCPDRW	TD	TOTSSS	TVRAV	TVRFV	TVRVV	VTK	WLI				
•	•	•	•	•	•	•	•	•	•	•	•	•	•	•	•	•	•	•	•	•	•	•	•	•	•	•	•	•	•	•	•	•	•	•	•	•	•	•	•	•	•	•	•	•	•	•

**Construction Upgrades**

APC	ET	PE
•	•	•

**Door Options**

CG	DPSRR
•	•

<b>CNTYSB30SA</b>	944	1063	1085	1130	1137	1161	1205	1213	1263	1297	1349	1403
<b>CNTYSB33SA</b>	970	1103	1128	1172	1182	1205	1255	1260	1313	1347	1403	1459
<b>CNTYSB36SA</b>	996	1144	1168	1216	1225	1253	1302	1306	1362	1397	1457	1515
<b>CNTYSB39SA</b>	1082	1231	1256	1306	1317	1344	1398	1403	1463	1503	1565	1627

**Custom Modifications**

AUTHL	AUTHR	CBO	CCO	CFNTO	CFP	CFRMO	CMAT	CND	DRT	DRWPWR	DRWSEC	DRWTK	EXBKL	EXBKR	EXL	EXR	FB	FFDL	FPEB	FTK	FTKAV	FTKFV	ID	INVFRM	LTI	MIP	P	PTOWB	RD	RECTKALL	RECTKBK	RECTKL	RECTKR	RT	SCPDRW	TD	TOTSSS	TVRAV	TVRFV	TVRVV	VTK	WLI				
•	•	•	•	•	•	•	•*	•	•	•	•	•*	•	•	•	•	•	•	•	•	•	•	•	•	•	•	•	•	•	•	•	•	•	•	•	•	•	•	•	•	•	•	•	•	•	•

\*Not available on 39" wide

**Construction Upgrades**

APC	ET	PE
•	•	•

**Door Options**

CG	DPSRR
•	•

**Sink Base Corner Cabinets**

- SBCs use the wall space the nomenclature implies.
- Remember to use 3" filler on adjoining cabinets.
- The adjoining run of cabinets will cover the void.
- The L or R in the cabinet nomenclature indicates the location of the void to ensure clearance; it is not recommended to place SBC cabinets next to 27" deep appliances.

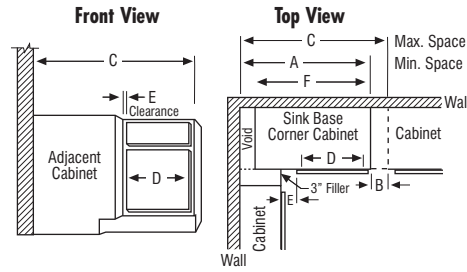

Model	A Min. Space	B Max. Pull*	C Max. Space	D Cabinet Opening	E* Full Overlay**		E* Partial Overlay		F Actual Cabinet
					At Min.	At Max.	At Min.	At Max.	
SBC51	51"	4 1/2"	55 1/2"	21"	3 1/4"	7 3/4"	4"	8 1/2"	48"
SBC54	54"	4 1/2"	58 1/2"	24"	3 1/4"	7 3/4"	4"	8 1/2"	51"
SBC57	57"	4 1/2"	61 1/2"	27"	3 1/4"	7 3/4"	4"	8 1/2"	54"
SBC60	60"	4 1/2"	64 1/2"	30"	3 1/4"	7 3/4"	4"	8 1/2"	57"
SBC63	63"	4 1/2"	67 1/2"	33"	3 1/4"	7 3/4"	4"	8 1/2"	60"

\*Minimum/maximum space between inside edge of door and face of filler/adjoining cabinet. If cabinet is pulled to maximum stated dimension, filler will need to be cleared for proper attachment.  
 \*\*Full overlay styles must be pulled an additional 1 1/2" to ensure proper drawer/pull clearance. 1 1/2" pull is not included in minimum and maximum list.

**SINK BASE CORNER**

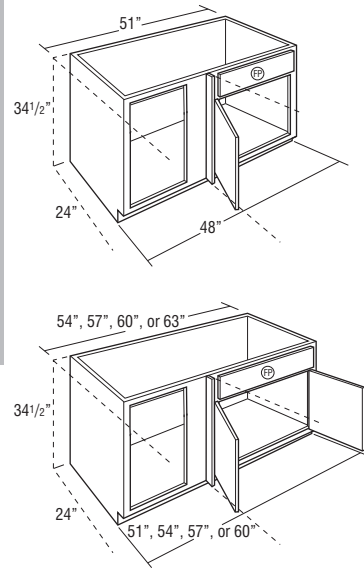

Model	1	2	3	4	5	6
<b>SBC51 L or R</b>	885	928	1007	1066	1113	1141
<b>SBC54 L or R</b>	1005	1054	1143	1211	1265	1296
<b>SBC57 L or R</b>	1013	1063	1152	1220	1275	1306
<b>SBC60 L or R</b>	1021	1071	1161	1230	1285	1316
<b>SBC63 L or R</b>	1029	1079	1170	1239	1295	1326

- On void side, do not install next to an appliance deeper than standard cabinet depth due to clearance needed for the door.
- Includes one 3" filler, shipped unattached.
- L or R indicates void. L (left) void shown.
- Mini Touch-up Kit (MTUK) included. MTUK includes small touch-up marker and small fill stick.

	Sink Base Frame Opening Width	Sink Base Cabinet Equivalent Width	# of Doors	Full Overlay Door Style		Partial Overlay Door Size	
				Width	Height	Width	Height
SBC51	21"	24"	1	23 1/2"	23"	22"	21 1/2"
SBC54	24"	27"	2	13 3/16"	23"	12 7/16"	21 1/2"
SBC57	27"	30"	2	14 11/16"	23"	13 15/16"	21 1/2"
SBC60	30"	33"	2	16 3/16"	23"	15 7/16"	21 1/2"
SBC63	33"	36"	2	17 11/16"	23"	16 15/16"	21 1/2"

Model	7	8	9	10	11	12	13	14	15	16	17	18
<b>SBC51 L or R</b>	1173	1204	1227	1274	1282	1306	1358	1363	1416	1454	1510	1570
<b>SBC54 L or R</b>	1332	1367	1394	1447	1456	1483	1542	1549	1609	1651	1716	1783
<b>SBC57 L or R</b>	1343	1378	1405	1458	1468	1495	1555	1561	1621	1664	1729	1797
<b>SBC60 L or R</b>	1353	1389	1416	1470	1479	1507	1567	1573	1634	1677	1743	1811
<b>SBC63 L or R</b>	1364	1400	1427	1481	1491	1519	1579	1585	1647	1690	1756	1825

**Custom Modifications**

AUTHL	CBO	CCO	CFNTO	CFP	CFRMO	CMAT	CND	DRT	DRWPWR	DRWSEC	DRWTK	EXBKL	EXL	EXR	FB	FD	FFDL	FFDR	FPFB	FTK	FTKEV	ID	INFRM	LTI	MIP	P	PTOWB	RD	RECTKALL	RECTKLBK	RECTKL	RECTKR	RT	SCPRW	TD	TOTSSS	TVRAV	TVRFV	TVRVV	VTK	WLU	
•	•	•	•	•	•	•	•	•	•	•	•	•	•	•	•	•	•	•	•	•	•	•	•	•	•	•	•	•	•	•	•	•	•	•	•	•	•	•	•	•	•	•

\*Face Frame and Door on End modification not available on the void side of the cabinet.

**Construction Upgrades**

APC	ET	PE
•	•	•

**Door Options**

CG	DPSRR
•	•

**Base Corner Cabinets**

- BCs use the wall space the nomenclature implies.
- Remember to use 3" filler on adjoining cabinets.
- The adjoining run of cabinets will cover the void.
- BCFW specifies full width blind corner base cabinet.
- The L or R in the cabinet nomenclature indicates the location of the void to ensure clearance; it is not recommended to place BC cabinets next to 27" deep appliances.

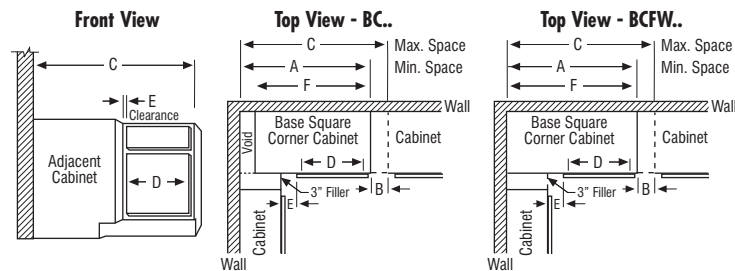

**BASE CORNER**

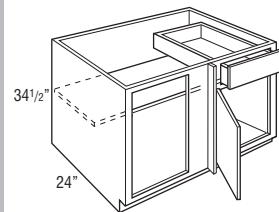

- BC36 L or R - 27" wide
- BC39 L or R - 30" wide
- BC42 L or R - 39" wide
- BC45 L or R - 42" wide
- BC48 L or R - 45" wide

Model	1	2	3	4	5	6
BC36 L or R	853	891	966	1016	1005	1016
BC39 L or R	891	935	1013	1071	1076	1096
BC42 L or R	932	976	1058	1119	1146	1173
BC45 L or R	950	995	1083	1144	1182	1213
BC48 L or R	970	1017	1103	1168	1220	1250

- On void side, do not install next to an appliance deeper than standard cabinet depth due to clearance needed for the door and drawer.
- Includes one 3" filler, shipped unattached.
- L or R indicates void. L (left) void shown.
- Adjustable 15" deep shelves.

**BASE CORNER with PULL-OUT**

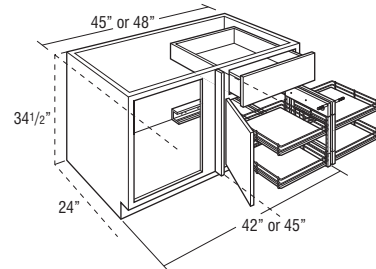

BC45PO L or R  
BC48PO L or R

BC45PO L or R	2727	2772	2860	2921	2959	2990
BC48PO L or R	2747	2794	2880	2945	2997	3027

- On pull-out side of cabinet, do not install next to a wall or appliance due to clearance needed for pull-out to come out of cabinet. On void side, do not install next to an appliance deeper than standard cabinet depth due to clearance needed for door to open fully to allow pull-out to be used and also for the drawer to open fully.
- Pull-out features four wood shelves with chrome surround. Smart Stop not available.
- Includes one 3" filler, shipped unattached.
- L or R indicates void. L (left) void shown.
- Adjacent cabinet hardware may interfere with shelf position on pull-out.
- Wire pull-out dimensions are 10 5/8" W x 17 1/8" D x 2 3/4" H.
- For pull-out to open, 10" of adjacent space is required with no obstruction beyond 1" in front of the cabinet face frame.

**BASE CORNER FULL WIDTH**

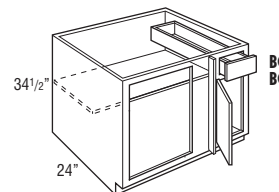

BCFW36 L or R - 36" wide  
BCFW39 L or R - 39" wide

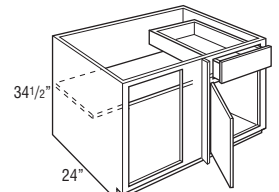

BCFW42 L or R - 42" wide  
BCFW45 L or R - 45" wide  
BCFW48 L or R - 48" wide

BCFW36 L or R	931	975	1043	1099	1122	1142
BCFW39 L or R	942	988	1080	1138	1168	1194
BCFW42 L or R	954	999	1114	1174	1214	1243
BCFW45 L or R	970	1016	1144	1207	1249	1280
BCFW48 L or R	986	1034	1172	1242	1280	1319

- On void side, do not install next to an appliance deeper than standard cabinet depth due to clearance needed for the door and drawer.
- Includes one 3" filler, shipped unattached.
- L or R indicates void. L (left) void shown.
- Adjustable 15" deep shelves.

Model	A	B	C	D	E*		E*		F	Face Frame	Full Overlay	Partial Overlay
	Min. Space	Max. Pull*	Max. Space	Cabinet Opening	Full Overlay** At Min.	Full Overlay** At Max.	Partial Overlay At Min.	Partial Overlay At Max.	Actual Cabinet	Opening Width	Door Width	Door Width
BC36	36"	6"	42"	7 1/2"	1 3/4"	7 3/4"	2 1/2"	8 1/2"	27"	7 1/2"	10"	8 1/2"
BC39	39"	4 1/2"	43 1/2"	9"	3 1/4"	7 3/4"	4"	8 1/2"	30"	9"	11 1/2"	10"
BC42	42"	6"	48"	13 1/2"	1 3/4"	7 3/4"	2 1/2"	8 1/2"	39"	13 1/2"	16"	14 1/2"
BC45/BC45PO	45"	4 1/2"	49 1/2"	15"	3 1/4"	7 3/4"	4"	8 1/2"	42"	15"	17 1/2"	16"
BC48/BC48PO	48"	5"	51"	16 1/2"	4 1/4"	7 3/4"	5 1/2"	8 1/2"	45"	16 1/2"	19"	17 1/2"
BCFW36/BCFW36FH	36"	5"	41"	7 1/2"	1 3/4"	6 3/4"	2 1/4"	7 1/2"	36"	17 1/2"	10"	8 1/2"
BCFW39/BCFW39FH	39"	3 1/2"	42 1/2"	9"	3 1/4"	6 3/4"	4"	7 1/2"	39"	19"	11 1/2"	10"
BCFW42/BCFW42FH	42"	9"	51"	13 1/2"	1 3/4"	10 3/4"	2 1/2"	11 1/2"	42"	13 1/2"	16"	14 1/2"
BCFW45/BCFW45FH/BCFW45PO	45"	7 1/2"	52 1/2"	15"	3 1/4"	10 3/4"	4"	11 1/2"	45"	15"	17 1/2"	16"
BCFW48/BCFW48CPO/BCFW48FH/BCFW48PO	48"	4 1/2"	52 1/2"	18"	3 1/4"	7 3/4"	4"	8 1/2"	48"	18"	20 1/2"	19"
BCFW48SP	48"	4 1/2"	52 1/2"	18"	3 1/4"	7 3/4"	4"	8 1/2"	48"	18"	20 1/2"	19"

\*Minimum/maximum space between inside edge of door and face of filler/adjoining cabinet. If cabinet is pulled to maximum stated dimension, filler will need to be deleted for proper attachment.  
\*\*Full overlay styles must be pulled an additional 1 1/2" to ensure proper drawer/pull clearance. 1 1/2" pull is not included in minimum and maximum list.

Model	7	8	9	10	11	12	13	14	15	16	17	18
BC36 L or R	1118	1072	1091	1132	1140	1161	1203	1211	1256	1290	1339	1392
BC39 L or R	1175	1155	1175	1219	1228	1253	1299	1303	1353	1390	1445	1502
BC42 L or R	1229	1239	1263	1309	1319	1345	1396	1400	1456	1494	1552	1614
BC45 L or R	1259	1278	1304	1351	1363	1389	1443	1448	1504	1546	1604	1668
BC48 L or R	1285	1319	1345	1396	1405	1431	1488	1494	1552	1593	1655	1720

**Custom Modifications**

AUTHL	AUTHR	CBO	CCO	CFNTD	CFP	CFRMO	CMAT	CND	DRT	DRWPWR	DRWSEC	DRWTK	EXBKL	EXBKR	EXL	EXR	FB	FFDL	FFDR	FFEB	FTK	FTKAV	FTKFEV	ID	INVFRM	LTI	MIP	P	PTOWB	RD	RECTKALL	RECTKLBK	RECTKL	RECTKR	RT	SCPDWR	TD	TOTSSS	TVRAV	TVRFV	TVRVV	VTK	WLI		
•	•	•	•	•	•	•	•	•	•	•*	•*	•	•	•	•	•	•	•	•	•	•	•	•	•	•	•	•	•	•	•	•	•	•	•	•	•	•	•	•	•	•	•	•	•	•

\*Not available on 36", 39", and 42" wide    \*Available only on 45" wide    \*Face Frame and Door on End modification not available on the void side of the cabinet.    †Not available on 36" and 39" wide

**Construction Upgrades**

APC	ET	PE
•	•	•

**Door Options**

CG	DPSRR
•	•

BC45PO L or R	3036	3055	3081	3128	3140	3166	3220	3225	3281	3323	3381	3445
BC48PO L or R	3062	3096	3122	3173	3182	3208	3265	3271	3329	3370	3432	3497

**Custom Modifications**

AUTHL	AUTHR	CBO	CCO	CFNTD	CFP	CFRMO	CMAT	CND	DRT	DRWPWR	DRWSEC	DRWTK	EXBKL	EXBKR	EXL	EXR	FB	FFDL	FFDR	FFEB	FTK	FTKAV	FTKFEV	ID	INVFRM	LTI	MIP	P	PTOWB	RD	RECTKALL	RECTKLBK	RECTKL	RECTKR	RT	SCPDWR	TD	TOTSSS	TVRAV	TVRFV	TVRVV	VTK	WLI			
•	•	•	•	•	•	•	•	•	•	•	•	•	•	•	•	•	•	•	•	•	•	•	•	•	•	•	•	•	•	•	•	•	•	•	•	•	•	•	•	•	•	•	•	•	•	•

**Construction Upgrades**

APC	ET	PE
•	•	•

**Door Options**

CG	DPSRR
•	•

BCFW36 L or R	1211	1207	1226	1273	1284	1306	1354	1362	1416	1450	1506	1566
BCFW39 L or R	1253	1262	1285	1333	1344	1368	1420	1426	1481	1519	1579	1644

BCFW42 L or R	1293	1311	1339	1389	1399	1425	1479	1484	1544	1583	1647	1712
BCFW45 L or R	1328	1351	1378	1430	1445	1472	1524	1532	1593	1635	1699	1768
BCFW48 L or R	1366	1394	1420	1475	1487	1514	1568	1575	1638	1683	1749	1819

**Custom Modifications**

AUTHL	AUTHR	CBO	CCO	CFNTD	CFP	CFRMO	CMAT	CND	DRT	DRWPWR	DRWSEC	DRWTK	EXBKL	EXBKR	EXL	EXR	FB	FFDL	FFDR	FFEB	FTK	FTKAV	FTKFEV	ID	INVFRM	LTI	MIP	P	PTOWB	RD	RECTKALL	RECTKLBK	RECTKL	RECTKR	RT	SCPDWR	TD	TOTSSS	TVRAV	TVRFV	TVRVV	VTK	WLI		
•	•	•	•	•	•	•	•	•	•	•*	•*	•	•	•	•	•	•	•	•	•	•	•	•	•	•	•	•	•	•	•	•	•	•	•	•	•	•	•	•	•	•	•	•	•	•

\*Not available on 36", 39", and 42" wide    \*Available only on 45" and 48" wide    \*Face Frame and Door on End modification not available on the void side of the cabinet.    †Not available on 36" and 39" wide

**Construction Upgrades**

APC	ET	PE
•	•	•

**Door Options**

CG	DPSRR
•	•

**BASE CORNER FULL WIDTH, FULL HEIGHT**

36", 39", 42", 45", or 48"

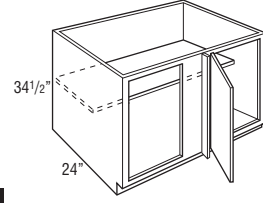

Model	1	2	3	4	5	6
<b>BCFW36FH L or R</b>	747	793	859	916	940	959
<b>BCFW39FH L or R</b>	758	806	896	955	986	1011
<b>BCFW42FH L or R</b>	770	817	930	991	1032	1060
<b>BCFW45FH L or R</b>	786	834	960	1024	1067	1097
<b>BCFW48FH L or R</b>	802	852	988	1059	1098	1136

- On void side, do not install next to an appliance deeper than standard cabinet depth due to clearance needed for the door.
- Includes one 3" filler, shipped unattached.
- L or R indicates void. L (left) void shown.
- Adjustable 15" deep shelves.

**BASE CORNER FULL WIDTH with CURVED PULL-OUT**

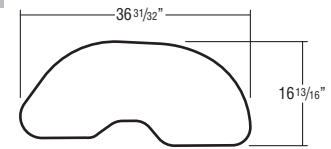
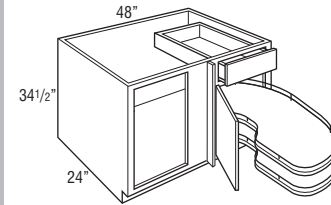

Model	3822	3870	4008	4078	4116	4155
<b>BCFW48CPO L or R</b>	3822	3870	4008	4078	4116	4155

- On void side, do not install next to an appliance deeper than standard cabinet depth due to clearance needed for the door and drawer.
- Includes one 3" filler, shipped unattached.
- Includes two pull-out shelves with chrome wire surround and Smart Stop closing mechanism. Shelf height can be adjusted in the field.
- When shelf is fully opened, it extends 27 3/4" from front edge of the face frame. Unit pulls out to the front only and can be installed next to a wall or appliance without side interference.
- Distance from surface of shelf to top edge of wire surround is 1 11/16".
- L or R indicates void. L (left) void shown.
- Maximum Weight Capacity: 44 lbs. per shelf.

**BASE CORNER FULL WIDTH with PULL-OUT**

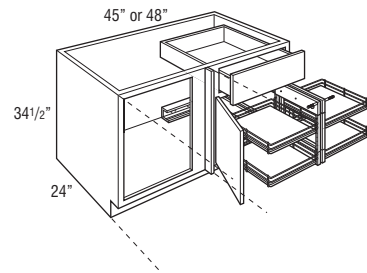

Model	2747	2793	2921	2984	3026	3057
<b>BCFW45PO L or R</b>	2747	2793	2921	2984	3026	3057
<b>BCFW48PO L or R</b>	2763	2811	2949	3019	3057	3096

- On pull-out side of cabinet, do not install next to a wall or appliance due to clearance needed for pull-out to come out of cabinet. On void side, do not install next to an appliance deeper than standard cabinet depth due to clearance needed for door to open fully to allow pull-out to be used and also for the drawer to open fully.
- Includes one 3" filler, shipped unattached.
- L or R indicates void. L (left) void shown.
- Pull-out features four wood shelves with chrome surround. Smart Stop not available.
- Wire pull-out interior dimensions are 10 5/8" W x 17 1/8" D x 2 3/4" H.
- For pull-out to open, 10" of adjacent space is required with no obstruction beyond 1" in front of the cabinet face frame.
- Adjacent cabinet hardware may interfere with shelf position on pull-out.

**BASE CORNER FULL WIDTH with ROLL TRAYS & SWING-OUT**

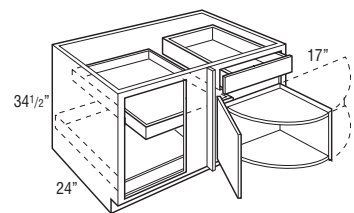

Model	1893	1986	2121	2235	2253	2253
<b>BCFW48SP L or R</b>	1893	1986	2121	2235	2253	2253

- On swing-out side of cabinet, do not install next to a wall or appliance due to clearance needed for swing-out to come out of cabinet and allow full access to other contents inside of cabinet. On void side, do not install next to an appliance deeper than standard cabinet depth due to clearance needed for door to open fully to allow swing-out to be used and also for the drawer to open fully.
- Includes one 3" filler, shipped unattached.
- L or R indicates void. L (left) void shown.
- Swing-out hinged opposite door.
- Roll trays and swing-outs installed.
- Insert swing on a base corner full width cabinet is 17".
- Swing-out is 3/4" laminated furniture board.

Model	7	8	9	10	11	12	13	14	15	16	17	18
<b>BCFW36FH L or R</b>	1027	1022	1043	1092	1102	1122	1173	1180	1234	1269	1323	1383
<b>BCFW39FH L or R</b>	1069	1077	1102	1152	1162	1184	1239	1244	1299	1338	1396	1461
<b>BCFW42FH L or R</b>	1109	1126	1156	1208	1217	1241	1298	1302	1362	1402	1464	1529
<b>BCFW45FH L or R</b>	1144	1166	1195	1249	1263	1288	1343	1350	1411	1454	1516	1585
<b>BCFW48FH L or R</b>	1182	1209	1237	1294	1305	1330	1387	1393	1456	1502	1566	1636

**Custom Modifications**

AUTHL	AUTHR	CBO	CCO	CFNTO	CFP	CFRMO	CMAT	CND	DRT	DRWPWR	DRWSEC	DRWTK	EXBKL	EXBKR	EXL	EXR	FB	FD	FFDL	FFDR	FPEB	FTK	FTKAV	FTKRV	ID	INVFRM	LTI	MIP	P	PTOWB	RD	RECTKALL	RECTKBK	RECTKL	RECTKR	RT	SCPRDR	TD	TOTSSS	TVRAV	TVRFV	TVRVV	VTK	WLI		
•	•	•	•	•	•	•	•	•	•	•	•	•	•	•	•	•	•	•	•	•	•	•	•	•	•	•	•	•	•	•	•	•	•	•	•	•	•	•	•	•	•	•	•	•	•	•

\*Face Frame and Door on End modification not available on the void side of the cabinet. \*Not available on 36" and 39" wide

**Construction Upgrades**

APC	ET	PE
•	•	•

**Door Options**

CG	DPSRR
•	•

Model	4202	4230	4256	4311	4323	4350	4404	4411	4474	4519	4585	4655
<b>BCFW48CPO L or R</b>	4202	4230	4256	4311	4323	4350	4404	4411	4474	4519	4585	4655

**Custom Modifications**

AUTHL	AUTHR	CBO	CCO	CFNTO	CFP	CFRMO	CMAT	CND	DRT	DRWPWR	DRWSEC	DRWTK	EXBKL	EXBKR	EXL	EXR	FB	FD	FFDL	FFDR	FPEB	FTK	FTKAV	FTKRV	ID	INVFRM	LTI	MIP	P	PTOWB	RD	RECTKALL	RECTKBK	RECTKL	RECTKR	RT	SCPRDR	TD	TOTSSS	TVRAV	TVRFV	TVRVV	VTK	WLI			
•	•	•	•	•	•	•	•	•	•	•	•	•	•	•	•	•	•	•	•	•	•	•	•	•	•	•	•	•	•	•	•	•	•	•	•	•	•	•	•	•	•	•	•	•	•	•	•

**Construction Upgrades**

APC	ET	PE
•	•	•

**Door Options**

CG	DPSRR
•	•

Model	3105	3128	3155	3207	3222	3249	3301	3309	3370	3412	3476	3545
<b>BCFW45PO L or R</b>	3105	3128	3155	3207	3222	3249	3301	3309	3370	3412	3476	3545
<b>BCFW48PO L or R</b>	3143	3171	3197	3252	3264	3291	3345	3352	3415	3460	3526	3596

**Custom Modifications**

AUTHL	AUTHR	CBO	CCO	CFNTO	CFP	CFRMO	CMAT	CND	DRT	DRWPWR	DRWSEC	DRWTK	EXBKL	EXBKR	EXL	EXR	FB	FD	FFDL	FFDR	FPEB	FTK	FTKAV	FTKRV	ID	INVFRM	LTI	MIP	P	PTOWB	RD	RECTKALL	RECTKBK	RECTKL	RECTKR	RT	SCPRDR	TD	TOTSSS	TVRAV	TVRFV	TVRVV	VTK	WLI			
•	•	•	•	•	•	•	•	•	•	•	•	•	•	•	•	•	•	•	•	•	•	•	•	•	•	•	•	•	•	•	•	•	•	•	•	•	•	•	•	•	•	•	•	•	•	•	•

**Construction Upgrades**

APC	ET	PE
•	•	•

**Door Options**

CG	DPSRR
•	•

Model	2462	2384	2431	2524	2545	2593	2693	2708	2816	2890	3005	3127
<b>BCFW48SP L or R</b>	2462	2384	2431	2524	2545	2593	2693	2708	2816	2890	3005	3127

**Custom Modifications**

AUTHL	AUTHR	CBO	CCO	CFNTO	CFP	CFRMO	CMAT	CND	DRT	DRWPWR	DRWSEC	DRWTK	EXBKL	EXBKR	EXL	EXR	FB	FD	FFDL	FFDR	FPEB	FTK	FTKAV	FTKRV	ID	INVFRM	LTI	MIP	P	PTOWB	RD	RECTKALL	RECTKBK	RECTKL	RECTKR	RT	SCPRDR	TD	TOTSSS	TVRAV	TVRFV	TVRVV	VTK	WLI			
•	•	•	•	•	•	•	•	•	•	•	•	•	•	•	•	•	•	•	•	•	•	•	•	•	•	•	•	•	•	•	•	•	•	•	•	•	•	•	•	•	•	•	•	•	•	•	•

**Construction Upgrades**

APC	ET	PE
•	•	•

**Door Options**

CG	DPSRR
•	•













135° CORNER INSIDE BASE

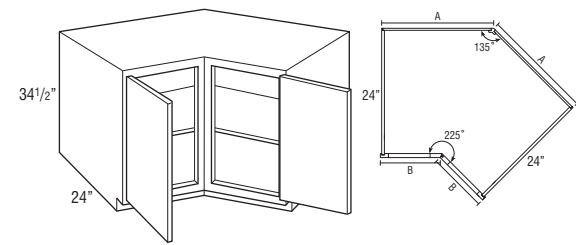

Model	1	2	3	4	5	6
BFH21CIA	1893	1986	2121	2235	2253	2253
BFH24CIA	1986	2087	2226	2347	2366	2366
BFH27CIA	2083	2186	2331	2460	2479	2479

- Doors are hinged on outside of frame.
- Adjustable shelves cannot be removed from the cabinet.

Model	A Dimension	B Dimension
BFH21CIA	21"	11 3/32"
BFH24CIA	24"	14 3/32"
BFH27CIA	27"	17 3/32"

A indicates back width of cabinet and wall space.  
B indicates face frame width.

BASE END CABINET

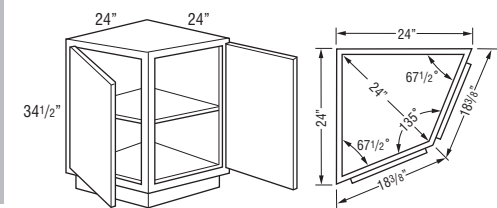

Model	1	2	3	4	5	6
BEC24	840	896	985	1053	1189	1249

- Wall width is 24" x 24".
- 24" W x 24" D x 34 1/2" H.
- 24" from outside corner point to frame face.
- Cabinets constructed with top.
- One adjustable shelf.
- Cabinet may be installed against either end of a run.

TWO DRAWER BASE with FILE DRAWER

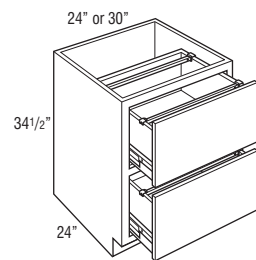

Model	1	2	3	4	5	6
2DB24FD	1685	1685	1685	1685	1685	1685
2DB30FD	1999	1999	1999	1999	2290	2345

- Includes Filing System Hardware Kit, which accommodates letter and legal filing.
- Drawers utilize 125 lb. full extension progressive side-mount guide, does not feature soft-close guide.
- Depth can be reduced to a minimum of 21".
- Exterior drawer box height is 10".

TWO DRAWER BASE

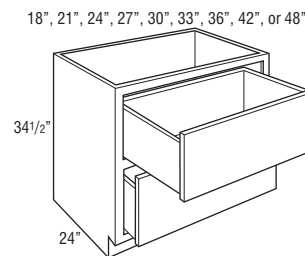

Model	1	2	3	4	5	6
2DB18	1264	1264	1264	1264	1293	1293
2DB21	1326	1326	1326	1326	1374	1374
2DB24	1458	1458	1458	1458	1458	1458
2DB27	1615	1615	1615	1615	1759	1788
2DB30	1771	1771	1771	1771	2062	2119
2DB33	1813	1813	1813	1813	2143	2209
2DB36	1858	1858	1858	1858	2223	2300
2DB42	2386	2386	2386	2386	2776	2859
2DB48	2554	2554	2554	2554	2971	3059

- Exterior drawer box height is 10".
- When SCPDRW is selected, the top drawer will utilize a 6 3/8" high drawer box instead of the current 10" high drawer box, creating a clearance of 6 5/8" for the cooktop.
- When 2DB48 is ordered in Whittaker with DFF5PC, drawer fronts will have a vertical cross rail with two center panels.

Model	7	8	9	10	11	12	13	14	15	16	17	18
BFH21CIA	2462	2384	2431	2524	2545	2593	2693	2708	2816	2890	3005	3127
BFH24CIA	2584	2503	2553	2649	2672	2723	2827	2842	2957	3035	3156	3283
BFH27CIA	2708	2622	2673	2775	2799	2852	2963	2976	3098	3179	3306	3438

Custom Modifications

AUTHL	AUTHR	CBO	CCO	CFNTO	CFP	CFRMO	CMAT	CND	DRT	DRWPWR	DRWSEC	DRWTK	EXBKL	EXBKR	EXL	EXR	FB	FD	FFDL	FPEB	FTK	FTKAV	FTKFV	ID	INVFRM	LTI	MIP	P	PTOWB	RD	RECTKALL	RECTKBK	RECTKL	RECTKR	RT	SCPDRW	TD	TOTSSS	TVRAV	TVRFV	TVRVV	VTK	WLI
•	•	•											•	•	•	•					•	•	•				•	•													•	•	

\*Not available on 21" and 24" wide

Construction Upgrades

APC	ET	PE
•		•

Door Options

CG	DPSRR
	•

Model	1	2	3	4	5	6
BEC24	1162	1325	1349	1403	1418	1446

Custom Modifications

AUTHL	AUTHR	CBO	CCO	CFNTO	CFP	CFRMO	CMAT	CND	DRT	DRWPWR	DRWSEC	DRWTK	EXBKL	EXBKR	EXL	EXR	FB	FD	FFDL	FPEB	FTK	FTKAV	FTKFV	ID	INVFRM	LTI	MIP	P	PTOWB	RD	RECTKALL	RECTKBK	RECTKL	RECTKR	RT	SCPDRW	TD	TOTSSS	TVRAV	TVRFV	TVRVV	VTK	WLI		
		•	•										•	•	•	•						•	•	•																				•	•

Construction Upgrades

APC	ET	PE
•		

Door Options

CG	DPSRR
	•

Model	1	2	3	4	5	6
2DB24FD	1844	1769	1800	1859	1873	1907
2DB30FD	2186	2463	2505	2588	2610	2655

Custom Modifications

AUTHL	AUTHR	CBO	CCO	CFNTO	CFP	CFRMO	CMAT	CND	DRT	DRWPWR	DRWSEC	DRWTK	EXBKL	EXBKR	EXL	EXR	FB	FD	FFDL	FPEB	FTK	FTKAV	FTKFV	ID	INVFRM	LTI	MIP	P	PTOWB	RD	RECTKALL	RECTKBK	RECTKL	RECTKR	RT	SCPDRW	TD	TOTSSS	TVRAV	TVRFV	TVRVV	VTK	WLI	
•	•	•										•	•	•	•						•	•	•				•	•															•	•

Construction Upgrades

APC	ET	PE
•		•

Door Options

CG	DPSRR

Model	1	2	3	4	5	6
2DB18	1403	1368	1392	1445	1458	1488
2DB21	1471	1454	1482	1539	1553	1581
2DB24	1617	1543	1573	1633	1645	1680
2DB27	1788	1889	1926	1997	2014	2053
2DB30	1959	2235	2277	2361	2383	2428
2DB33	2008	2332	2375	2465	2483	2533
2DB36	2054	2428	2472	2565	2585	2634
2DB42	2595	2996	3043	3143	3164	3216
2DB48	2777	3205	3255	3362	3386	3441

Custom Modifications

AUTHL	AUTHR	CBO	CCO	CFNTO	CFP	CFRMO	CMAT	CND	DRT	DRWPWR	DRWSEC	DRWTK	EXBKL	EXBKR	EXL	EXR	FB	FD	FFDL	FPEB	FTK	FTKAV	FTKFV	ID	INVFRM	LTI	MIP	P	PTOWB	RD	RECTKALL	RECTKBK	RECTKL	RECTKR	RT	SCPDRW	TD	TOTSSS	TVRAV	TVRFV	TVRVV	VTK	WLI		
•	•	•										•*	•	•	•						•	•	•				•	•																•	•

\*Not available on 42" and 48" wide \*Depth can be reduced to a minimum of 21" on 42" and 48" wide cabinets

Construction Upgrades

APC	ET	PE
•		•

Door Options

CG	DPSRR



**TWO DRAWER BASE, DROP-IN RANGE**

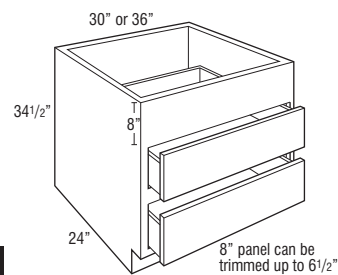

Model	1	2	3	4	5	6
<b>2DB30DR</b>	2025	2025	2025	2025	2349	2436
<b>2DB36DR</b>	2122	2122	2122	2122	2522	2637

• Exterior height of drawer boxes is 6 3/8\"

**TWO DRAWER BASE, DROP-IN RANGE and WARMING DRAWER**

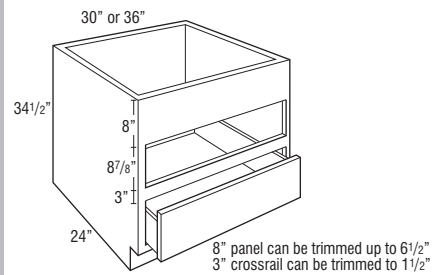

<b>2DB30DRWD</b>	1918	1918	1918	1918	2271	2600
<b>2DB36DRWD</b>	2024	2024	2024	2024	2466	2821

- Exterior height of bottom drawer box is 6 3/8\"
- For built-in appliance support, OCINSTALLKIT is included in 24\"
- OCINSTALLKIT weight limit is 400 lbs. per pair.

**THREE DRAWER BASE**

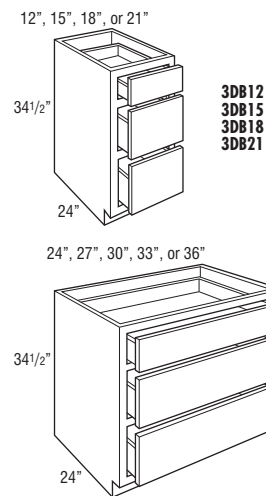

<b>3DB12</b>	1216	1216	1216	1216	1216	1216
<b>3DB15</b>	1270	1270	1270	1270	1270	1270
<b>3DB18</b>	1340	1340	1340	1340	1340	1340
<b>3DB21</b>	1408	1408	1408	1408	1408	1408
<b>3DB24</b>	1456	1456	1456	1456	1456	1456
<b>3DB27</b>	1554	1554	1554	1554	1563	1563
<b>3DB30</b>	1728	1728	1728	1728	1772	1772
<b>3DB33</b>	1800	1800	1800	1800	1881	1881
<b>3DB36</b>	1871	1871	1871	1871	1985	1985

• Exterior height of bottom 2 drawer boxes is 6 3/8\"

**THREE DRAWER BASE BUFFET**

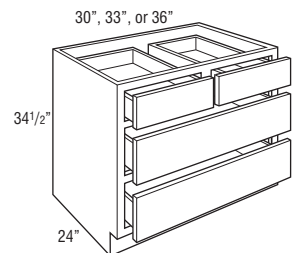

<b>3DBB30</b>	1986	1986	1986	1986	2039	2039
<b>3DBB33</b>	2070	2070	2070	2070	2160	2160
<b>3DBB36</b>	2152	2152	2152	2152	2284	2284

• Exterior height of bottom 2 drawer boxes is 6 3/8\"

Model	7	8	9	10	11	12	13	14	15	16	17	18
<b>2DB30DR</b>	2226	2565	2612	2707	2729	2777	2876	2887	2997	3073	3189	3315
<b>2DB36DR</b>	2332	2777	2828	2930	2948	3004	3115	3130	3250	3331	3454	3594

**Custom Modifications**

AUTHL	AUTHR	CBO	CCO	CFNTO	CFP	CFRMO	CMAT	CND	DRT	DRWPWR	DRWSEC	DRWTK	EXBKL	EXBKR	EXL	EXR	FB	FD	FFDL	FPEB	FTK	FTKAV	FTKFEV	ID	INVFRM	LTI	MIP	P	PTOWB	RD	RECTKALL	RECTKLBK	RECTKL	RECTKR	RT	SCPDWR	TD	TOTSSS	TVRAV	TVRFV	TVRVV	VTK	WLI			
•	•	•	•	•	•	•	•	•	•	•	•	•	•	•	•	•	•	•	•	•	•	•	•	•	•	•	•	•	•	•	•	•	•	•	•	•	•	•	•	•	•	•	•	•	•	•

**Construction Upgrades**

APC	ET	PE
•	•	•

**Door Options**

CG	DPSRR
•	•

<b>2DB30DRWD</b>	2101	2740	2792	2896	2923	2974	3083	3098	3219	3299	3429	3565
<b>2DB36DRWD</b>	2216	2974	3030	3143	3167	3227	3346	3361	3494	3582	3721	3868

**Custom Modifications**

AUTHL	AUTHR	CBO	CCO	CFNTO	CFP	CFRMO	CMAT	CND	DRT	DRWPWR	DRWSEC	DRWTK	EXBKL	EXBKR	EXL	EXR	FB	FD	FFDL	FPEB	FTK	FTKAV	FTKFEV	ID	INVFRM	LTI	MIP	P	PTOWB	RD	RECTKALL	RECTKLBK	RECTKL	RECTKR	RT	SCPDWR	TD	TOTSSS	TVRAV	TVRFV	TVRVV	VTK	WLI					
•	•	•	•	•	•	•	•	•	•	•	•	•	•	•	•	•	•	•	•	•	•	•	•	•	•	•	•	•	•	•	•	•	•	•	•	•	•	•	•	•	•	•	•	•	•	•	•	•

**Construction Upgrades**

APC	ET	PE
•	•	•

**Door Options**

CG	DPSRR
•	•

<b>3DB12</b>	1338	1273	1292	1335	1344	1366	1407	1416	1463	1496	1548	1608
<b>3DB15</b>	1396	1330	1349	1394	1403	1428	1475	1478	1529	1563	1618	1683
<b>3DB18</b>	1473	1401	1427	1473	1482	1507	1557	1562	1617	1656	1712	1782
<b>3DB21</b>	1551	1481	1506	1554	1566	1594	1647	1654	1710	1749	1809	1884
<b>3DB24</b>	1602	1530	1557	1609	1623	1650	1705	1712	1776	1816	1885	1959
<b>3DB27</b>	1710	1654	1685	1748	1761	1795	1860	1879	1947	2003	2076	2158
<b>3DB30</b>	1900	1877	1910	1985	2002	2040	2119	2142	2215	2288	2366	2463
<b>3DB33</b>	1981	1986	2026	2100	2118	2158	2243	2263	2344	2415	2501	2599
<b>3DB36</b>	2059	2097	2136	2215	2234	2276	2362	2385	2470	2542	2634	2737

**Custom Modifications**

AUTHL	AUTHR	CBO	CCO	CFNTO	CFP	CFRMO	CMAT	CND	DRT	DRWPWR	DRWSEC	DRWTK	EXBKL	EXBKR	EXL	EXR	FB	FD	FFDL	FPEB	FTK	FTKAV	FTKFEV	ID	INVFRM	LTI	MIP	P	PTOWB	RD	RECTKALL	RECTKLBK	RECTKL	RECTKR	RT	SCPDWR	TD	TOTSSS	TVRAV	TVRFV	TVRVV	VTK	WLI			
•	•	•	•	•	•	•	•	•	•	•*	•*	•	•	•	•	•	•	•	•	•	•	•*	•	•	•	•	•	•	•	•	•	•	•	•	•	•	•	•	•	•	•	•	•	•	•	•

\*Not available on 12" and 15" wide \*Available only on 18", 21", and 24" wide \*Not available on 12" wide

**Construction Upgrades**

APC	ET	PE
•	•	•

**Door Options**

CG	DPSRR
•	•

<b>3DBB30</b>	2185	2158	2198	2284	2302	2347	2436	2465	2548	2630	2721	2830
<b>3DBB33</b>	2277	2286	2330	2416	2434	2482	2580	2604	2694	2775	2876	2991
<b>3DBB36</b>	2368	2413	2457	2548	2568	2619	2716	2742	2840	2925	3027	3148

**Custom Modifications**

AUTHL	AUTHR	CBO	CCO	CFNTO	CFP	CFRMO	CMAT	CND	DRT	DRWPWR	DRWSEC	DRWTK	EXBKL	EXBKR	EXL	EXR	FB	FD	FFDL	FPEB	FTK	FTKAV	FTKFEV	ID	INVFRM	LTI	MIP	P	PTOWB	RD	RECTKALL	RECTKLBK	RECTKL	RECTKR	RT	SCPDWR	TD	TOTSSS	TVRAV	TVRFV	TVRVV	VTK	WLI			
•	•	•	•	•	•	•	•	•	•	•*	•*	•	•	•	•	•	•	•	•	•	•	•	•	•	•	•	•	•	•	•	•	•	•	•	•	•	•	•	•	•	•	•	•	•	•	•

\*Not available on 30" and 33" wide

**Construction Upgrades**

APC	ET	PE
•	•	•

**Door Options**

CG	DPSRR
•	•

**THREE DRAWER BASE with WOOD TIERED CUTLERY DIVIDER DRAWER**

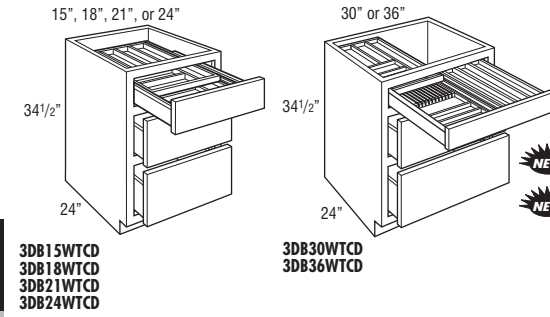

3DB15WTCO  
3DB18WTCO  
3DB21WTCO  
3DB24WTCO

3DB30WTCO  
3DB36WTCO

Model	1	2	3	4	5	6
3DB15WTCO	1724	1724	1724	1724	1724	1724
3DB18WTCO	1811	1811	1811	1811	1811	1811
3DB21WTCO	1897	1897	1897	1897	1897	1897
3DB24WTCO	1961	1961	1961	1961	1961	1961
<b>NEW</b> 3DB30WTCO	2417	2417	2417	2417	2461	2461
<b>NEW</b> 3DB36WTCO	2596	2596	2596	2596	2710	2710

- Exterior height for lower drawer boxes is 6 3/8".
- Exterior WTCO drawer box height is 3 3/4", interior height of top and bottom tier is 1 3/8".
- Wood Tiered Cutlery Divider Drawer is also available as an accessory. See page 580.

**THREE DRAWER BASE with WOOD TIERED K-CUP\* DRAWER**

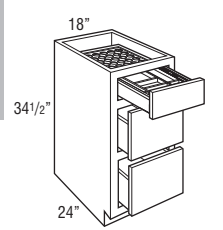

**THREE DRAWER BASE, WARMING DRAWER**

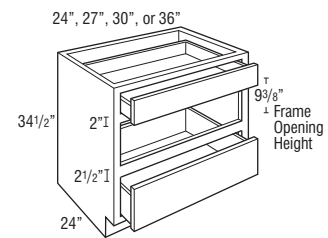

Model	Opening Width	Maximum Width	Opening Height	Maximum Height
3DB24WD	21"	22 1/2"	9 3/8"	11 3/8"
3DB27WD	24"	25 1/2"	9 3/8"	11 3/8"
3DB30WD	27"	28 1/2"	9 3/8"	11 3/8"
3DB36WD	33"	34 1/2"	9 3/8"	11 3/8"

Model	1	2	3	4	5	6
3DB18KCUO	1811	1811	1811	1811	1811	1811

- Holds 40 K-Cups.
- Exterior height for lower drawer boxes is 6 3/8".
- Exterior Wood Tiered K-Cup drawer box height is 3 3/4", interior height of top tier is 1 5/8", and interior height of bottom tier is 1 3/8".
- The Wood Tiered K-Cup Drawer is compatible with K-Cup pods only.
- Wood Tiered K-Cup Drawer is also available as an accessory. See page 581.

\*K-Cup is a registered trademark of Keurig Green Mountain, Inc.

3DB24WD	1472	1472	1472	1472	1572	1575
3DB27WD	1552	1552	1552	1552	1692	1692
3DB30WD	1683	1683	1683	1683	1859	1859
3DB36WD	1842	1842	1842	1842	2095	2095

- Exterior height of bottom drawer box is 6 3/8".
- For built-in appliance support, OCINSTALLKIT is included in 24" deep warming drawer cabinets (see page 582 for details), but will not be included when depth is modified.
- OCINSTALLKIT weight limit is 400 lbs. per pair.

Model	7	8	9	10	11	12	13	14	15	16	17	18
3DB15WTCO	1850	1784	1803	1848	1857	1882	1929	1932	1983	2017	2072	2137
3DB18WTCO	1944	1872	1898	1944	1953	1978	2028	2033	2088	2127	2183	2253
3DB21WTCO	2040	1970	1995	2043	2055	2083	2136	2143	2199	2238	2298	2373
3DB24WTCO	2107	2035	2062	2114	2128	2155	2210	2217	2281	2321	2390	2464

3DB30WTCO	2589	2566	2599	2674	2691	2729	2808	2831	2904	2977	3055	3152
3DB36WTCO	2784	2822	2861	2940	2959	3001	3087	3110	3195	3267	3359	3462

**Custom Modifications**

AUTHL	AUTHR	CBO	CCO	CFNTO	CFP	CFRMO	CMAT	CND	DRT	DRWPWR	DRWSEC	DRWTK	EXBKL	EXBKR	EXL	EXR	FB	FD	FFDL	FPEB	FTK	FTKAV	FTKFV	ID	INVFRM	LTI	MIP	P	PTOWB	RD	RECTKALL	RECTKLBK	RECTKL	RECTKR	RT	SCPDWR	TD	TOTSSS	TVRAV	TVRFV	TVRVV	VTK	WLI				
•	•	•	•	•	•	•	•	•	•	•	•	•	•	•	•	•	•	•	•	•	•	•	•	•	•	•	•	•	•	•	•	•	•	•	•	•	•	•	•	•	•	•	•	•	•	•	•

\*Not available on 15" wide

**Construction Upgrades**

APC	ET	PE
•	•	•

**Door Options**

CG	DPSRR
•	•†

†Available only on 30" and 36" wide

3DB18KCUO	1944	1872	1898	1944	1953	1978	2028	2033	2088	2127	2183	2253
-----------	------	------	------	------	------	------	------	------	------	------	------	------

**Custom Modifications**

AUTHL	AUTHR	CBO	CCO	CFNTO	CFP	CFRMO	CMAT	CND	DRT	DRWPWR	DRWSEC	DRWTK	EXBKL	EXBKR	EXL	EXR	FB	FD	FFDL	FPEB	FTK	FTKAV	FTKFV	ID	INVFRM	LTI	MIP	P	PTOWB	RD	RECTKALL	RECTKLBK	RECTKL	RECTKR	RT	SCPDWR	TD	TOTSSS	TVRAV	TVRFV	TVRVV	VTK	WLI					
•	•	•	•	•	•	•	•	•	•	•	•	•	•	•	•	•	•	•	•	•	•	•	•	•	•	•	•	•	•	•	•	•	•	•	•	•	•	•	•	•	•	•	•	•	•	•	•	•

**Construction Upgrades**

APC	ET	PE
•	•	•

**Door Options**

CG	DPSRR
•	•

3DB24WD	1609	1654	1685	1745	1753	1787	1849	1857	1923	1973	2043	2126
3DB27WD	1699	1792	1826	1895	1910	1947	2019	2037	2112	2175	2256	2346
3DB30WD	1842	1977	2012	2095	2114	2156	2244	2267	2350	2427	2517	2617
3DB36WD	2015	2218	2262	2350	2371	2418	2512	2535	2626	2710	2811	2921

**Custom Modifications**

AUTHL	AUTHR	CBO	CCO	CFNTO	CFP	CFRMO	CMAT	CND	DRT	DRWPWR	DRWSEC	DRWTK	EXBKL	EXBKR	EXL	EXR	FB	FD	FFDL	FPEB	FTK	FTKAV	FTKFV	ID	INVFRM	LTI	MIP	P	PTOWB	RD	RECTKALL	RECTKLBK	RECTKL	RECTKR	RT	SCPDWR	TD	TOTSSS	TVRAV	TVRFV	TVRVV	VTK	WLI					
•	•	•	•	•	•	•	•	•	•	•	•	•	•	•	•	•	•	•	•	•	•	•	•	•	•	•	•	•	•	•	•	•	•	•	•	•	•	•	•	•	•	•	•	•	•	•	•	•

**Construction Upgrades**

APC	ET	PE
•	•	•

**Door Options**

CG	DPSRR
•	•

**THREE DRAWER BASE with DEEP DRAWER**

24", 27", 30", 33", or 36"

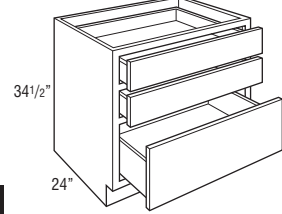

Model	1	2	3	4	5	6
<b>3DBDD24</b>	1796	1796	1796	1796	1796	1796
<b>3DBDD27</b>	1884	1884	1884	1884	1906	1906
<b>3DBDD30</b>	1971	1971	1971	1971	2015	2015
<b>3DBDD33</b>	2123	2123	2123	2123	2172	2172
<b>3DBDD36</b>	2286	2286	2286	2286	2339	2339

• Exterior height of bottom drawer box is 10".

**THREE DRAWER BASE BUFFET with DEEP DRAWER**

30", 33", or 36"

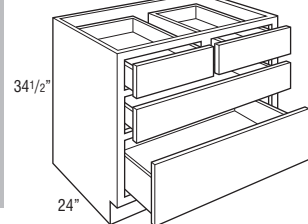

<b>3DBBDD30</b>	2255	2255	2255	2255	2307	2307
<b>3DBBDD33</b>	2430	2430	2430	2430	2486	2486
<b>3DBBDD36</b>	2617	2617	2617	2617	2677	2677

• Exterior height of bottom drawer box is 10".

**FOUR DRAWER BASE**

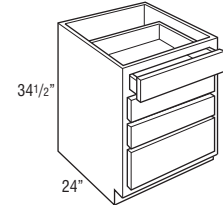

4DB12  
4DB15  
4DB18  
4DB21

24", 27", 30", 33", or 36"

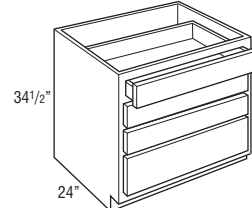

4DB24  
4DB27  
4DB30  
4DB33  
4DB36

<b>4DB12</b>	1437	1437	1437	1437	1437	1437
<b>4DB15</b>	1502	1502	1502	1502	1502	1502
<b>4DB18</b>	1572	1572	1572	1572	1572	1572
<b>4DB21</b>	1646	1646	1646	1646	1646	1646
<b>4DB24</b>	1738	1738	1738	1738	1738	1738
<b>4DB27</b>	1878	1878	1878	1878	1878	1878
<b>4DB30</b>	2027	2027	2027	2027	2027	2027
<b>4DB33</b>	2188	2188	2188	2188	2188	2188
<b>4DB36</b>	2363	2363	2363	2363	2363	2363

• Exterior height of bottom drawer box is 6 3/8".

Model	7	8	9	10	11	12	13	14	15	16	17	18
<b>3DBDD24</b>	1941	1870	1896	1949	1962	1989	2045	2051	2114	2157	2224	2298
<b>3DBDD27</b>	2042	1995	2024	2089	2102	2136	2203	2218	2286	2344	2416	2501
<b>3DBDD30</b>	2142	2119	2152	2228	2242	2283	2361	2384	2458	2530	2608	2703
<b>3DBDD33</b>	2308	2283	2318	2401	2416	2460	2542	2570	2646	2725	2811	2914
<b>3DBDD36</b>	2487	2460	2496	2586	2604	2648	2740	2769	2852	2937	3030	3140

**Custom Modifications**

AUTHL	AUTHR	CBO	CCO	CFNTO	CFP	CFRMO	CMAT	CND	DRT	DRWPWR	DRWSEC	DRWTK	EXBKL	EXBKR	EXL	EXR	FB	FD	FFDL	FPEB	FTK	FTKAV	FTKFV	ID	INVRM	LTI	MIP	P	PTOWB	RD	RECTKALL	RECTKLBK	RECTKL	RECTKR	RT	SCPDRW	TD	TOTSSS	TVRAV	TVRFV	TVRVV	VTK	WLI	
•	•	•	•	•	•	•				•		•	•	•	•	•				•	•	•					•			•	•	•										•		

**Construction Upgrades**

APC	ET	PE
•		•

**Door Options**

CG	DPSRR

<b>3DBBDD30</b>	2453	2426	2464	2550	2569	2614	2702	2730	2814	2897	2988	3097
<b>3DBBDD33</b>	2642	2614	2655	2749	2767	2816	2913	2945	3033	3123	3221	3338
<b>3DBBDD36</b>	2848	2816	2861	2963	2981	3036	3139	3172	3269	3367	3473	3599

**Custom Modifications**

AUTHL	AUTHR	CBO	CCO	CFNTO	CFP	CFRMO	CMAT	CND	DRT	DRWPWR	DRWSEC	DRWTK	EXBKL	EXBKR	EXL	EXR	FB	FD	FFDL	FPEB	FTK	FTKAV	FTKFV	ID	INVRM	LTI	MIP	P	PTOWB	RD	RECTKALL	RECTKLBK	RECTKL	RECTKR	RT	SCPDRW	TD	TOTSSS	TVRAV	TVRFV	TVRVV	VTK	WLI		
•	•	•	•	•	•	•				•*	•*	•	•	•	•	•				•	•	•					•			•	•	•											•		

\*Not available on 30" and 33" wide

**Construction Upgrades**

APC	ET	PE
•		•

**Door Options**

CG	DPSRR

<b>4DB12</b>	1579	1502	1525	1573	1582	1607	1659	1664	1719	1755	1813	1888
<b>4DB15</b>	1651	1572	1597	1646	1658	1683	1738	1745	1801	1839	1901	1978
<b>4DB18</b>	1729	1645	1674	1725	1738	1762	1824	1830	1889	1932	2000	2079
<b>4DB21</b>	1809	1725	1751	1808	1824	1851	1911	1918	1984	2028	2097	2181
<b>4DB24</b>	1911	1821	1850	1910	1924	1954	2016	2027	2096	2144	2220	2310
<b>4DB27</b>	2063	1965	1998	2062	2078	2110	2179	2188	2264	2316	2397	2495
<b>4DB30</b>	2230	2124	2157	2229	2244	2279	2353	2363	2444	2501	2590	2694
<b>4DB33</b>	2409	2293	2330	2408	2423	2463	2541	2554	2640	2701	2798	2911
<b>4DB36</b>	2599	2477	2516	2598	2618	2660	2744	2758	2851	2916	3021	3143

**Custom Modifications**

AUTHL	AUTHR	CBO	CCO	CFNTO	CFP	CFRMO	CMAT	CND	DRT	DRWPWR	DRWSEC	DRWTK	EXBKL	EXBKR	EXL	EXR	FB	FD	FFDL	FPEB	FTK	FTKAV	FTKFV	ID	INVRM	LTI	MIP	P	PTOWB	RD	RECTKALL	RECTKLBK	RECTKL	RECTKR	RT	SCPDRW	TD	TOTSSS	TVRAV	TVRFV	TVRVV	VTK	WLI		
•	•	•	•	•	•	•				•*	•*	•*	•	•	•	•				•	•	•*					•			•	•	•											•		

\*Not available on 12" and 15" wide \*Available only on 18", 21", and 24" wide \*Not available on 12" wide

**Construction Upgrades**

APC	ET	PE
•		•

**Door Options**

CG	DPSRR















**BASE DROP-IN RANGE CABINET**

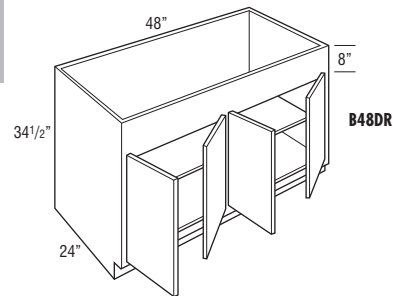
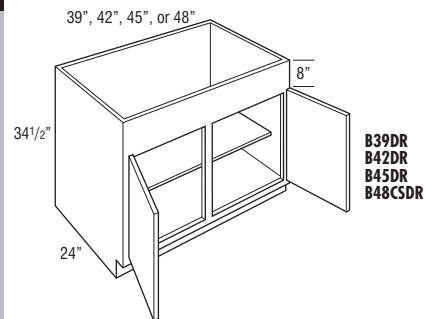
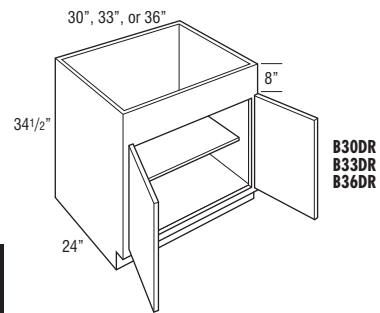

Model	1	2	3	4	5	6
<b>B30DR</b>	663	707	801	861	957	1005
<b>B33DR</b>	684	729	824	881	990	1042
<b>B36DR</b>	703	750	847	908	1026	1082
<b>B39DR</b>	762	813	919	984	1102	1163
<b>B42DR</b>	809	863	974	1042	1169	1231
<b>B45DR</b>	855	911	1030	1101	1237	1302
<b>B48CSDR</b>	901	960	1084	1161	1303	1372
<b>B48DR</b>	991	1056	1194	1278	1435	1511

- 8" panel can be trimmed up to 6 1/2".
- Adjustable 15" deep shelf.
- Can also be used with apron front sinks, refer to manufacturer's dimension requirements.

**BASE OVEN CABINET**

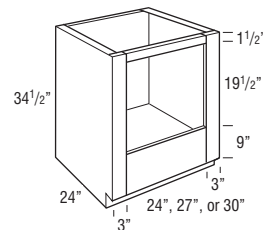

Model	Opening Width	Maximum Width	Opening Height	Maximum Height*
<b>B030</b>	24"	28 1/2"	19 1/2"	27 1/2"
<b>B033</b>	27"	31 1/2"	19 1/2"	27 1/2"
<b>B036</b>	30"	34 1/2"	19 1/2"	27 1/2"

\*Top frame cross rail can be removed during field installation if cabinet is properly installed between two adjacent cabinets, increasing the maximum height to 28 1/4".

<b>B030</b>	991	991	991	991	991	991
<b>B033</b>	1046	1046	1046	1046	1046	1046
<b>B036</b>	1118	1118	1118	1118	1118	1118

- Oven cabinet has laminated interior.
- May not hold cooktop and slide-in oven combination. Refer to cooktop and slide-in oven manufacturer specifications.
- If ordered with Heirlooming Technique, will not feature sand-through characteristics.
- For built-in appliance support, OCINSTALLKIT is included in 24" deep oven cabinets (see page 582 for details), but will not be included when depth is modified.
- OCINSTALLKIT weight limit is 400 lbs. per pair.

Model	7	8	9	10	11	12	13	14	15	16	17	18
<b>B30DR</b>	944	1063	1085	1130	1137	1161	1205	1213	1263	1297	1349	1403
<b>B33DR</b>	970	1103	1128	1172	1182	1205	1255	1260	1313	1347	1403	1459
<b>B36DR</b>	996	1144	1168	1216	1225	1253	1302	1306	1362	1397	1457	1515
<b>B39DR</b>	1082	1231	1256	1306	1317	1344	1398	1403	1463	1503	1565	1627
<b>B42DR</b>	1146	1306	1331	1387	1396	1425	1484	1490	1551	1594	1658	1725
<b>B45DR</b>	1212	1379	1407	1464	1475	1506	1568	1574	1640	1684	1753	1825
<b>B48CSDR</b>	1275	1454	1482	1543	1554	1586	1652	1659	1727	1773	1848	1922
<b>B48DR</b>	1405	1602	1633	1698	1712	1747	1818	1829	1902	1953	2036	2118

**Custom Modifications**

AUTHL	AUTHR	CBO	CCO	CFNTO	CFP	CFRMO	CMAT	CND	DRT	DRWPWR	DRWSEC	DRWTK	EXBKL	EXBKR	EXL	EXR	FB	FD	FFDL	FFDR	FPEB	FTK	FTKAV	FTKRV	ID	INVRM	LTI	MIP	P	PTOWB	RD	RECTKALL	RECTKRBK	RECTKL	RECTKR	RT	SCPRW	TD	TOTSSS	TVRAV	TVRFV	TVRVV	VTK	WLI	
•	•	•	•	•	•	•	•	•	•	•	•	•*	•	•	•	•	•	•	•	•	•	•	•	•	•	•	•	•	•	•	•	•	•	•	•	•	•	•	•	•	•	•	•	•	•

\*Available only on 30", 33", and 36" wide

**Construction Upgrades**

APC	ET	PE
•	•	•

**Door Options**

CG	DPSRR
•	•

<b>B030</b>	991	991	991	991	991	991	991	991	991	991	991	991
<b>B033</b>	1046	1046	1046	1046	1046	1046	1046	1046	1046	1046	1046	1046
<b>B036</b>	1118	1118	1118	1118	1118	1118	1118	1118	1118	1118	1118	1118

**Custom Modifications**

AUTHL	AUTHR	CBO	CCO	CFNTO	CFP	CFRMO	CMAT	CND	DRT	DRWPWR	DRWSEC	DRWTK	EXBKL	EXBKR	EXL	EXR	FB	FD	FFDL	FFDR	FPEB	FTK	FTKAV	FTKRV	ID	INVRM	LTI	MIP	P	PTOWB	RD	RECTKALL	RECTKRBK	RECTKL	RECTKR	RT	SCPRW	TD	TOTSSS	TVRAV	TVRFV	TVRVV	VTK	WLI	
•	•	•	•	•	•	•	•	•	•	•	•	•	•	•	•	•	•	•	•	•	•	•	•	•	•	•	•	•	•	•	•	•	•	•	•	•	•	•	•	•	•	•	•	•	•

**Construction Upgrades**

APC	ET	PE
•	•	•

**Door Options**

CG	DPSRR
•	•

**BASE BUILT-IN MICROWAVE CABINET with DRAWER**

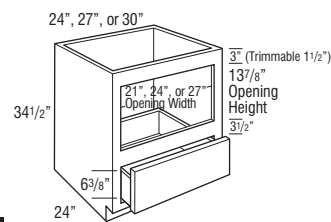

Model	Opening Width	Maximum Width	Opening Height	Maximum Height
BBMWD24	21"	22 1/2"	13 7/8"	16 7/8"
BBMWD27	24"	25 1/2"	13 7/8"	16 7/8"
BBMWD30	27"	28 1/2"	13 7/8"	16 7/8"

Model	1	2	3	4	5	6
BBMWD24	1301	1301	1301	1301	1301	1301
BBMWD27	1534	1534	1534	1534	1534	1545
BBMWD30	1544	1544	1544	1544	1544	1555

- Standard interior.
- For built-in appliance support, OCINSTALLKIT is included in 24" deep cabinets (see page 582 for details), but will not be included when depth is modified.
- OCINSTALLKIT weight limit is 400 lbs. per pair.
- The usable cabinet face height between top of drawer front and top of cabinet is 19 1/8" for partial overlay and 19 3/4" for full overlay. Be sure to verify overall appliance height, gap requirements, and cut-out dimensions with cabinet specifications.

**BASE MICROWAVE CABINET with DRAWER**

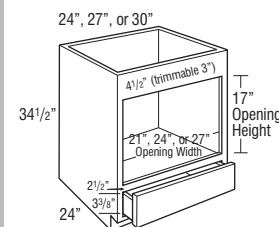

Model	Opening Width	Maximum Width	Opening Height	Maximum Height
BMWD24	21"	22 1/2"	17"	20"
BMWD27	24"	25 1/2"	17"	20"
BMWD30	27"	28 1/2"	17"	20"

Model	1	2	3	4	5	6
BMWD24	1370	1370	1370	1370	1370	1370
BMWD27	1494	1494	1494	1494	1494	1497
BMWD30	1624	1624	1624	1624	1624	1638

- Matching Interior Plywood (MIP) standard.
- Reinforced plywood floor.
- The usable cabinet face height between top of drawer front and top of cabinet is 23 1/2" for partial overlay and full overlay. Be sure to verify overall appliance height, gap requirements, and cut-out dimensions with cabinet specifications.

**BASE MICROWAVE CABINET with DEEP DRAWER**

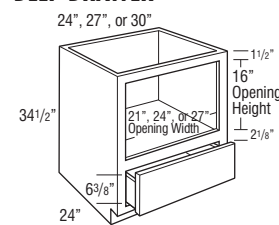

Model	Opening Width	Maximum Width	Opening Height	Maximum Height
BMWD24DD	21"	22 1/2"	16"	16"
BMWD27DD	24"	25 1/2"	16"	16"
BMWD30DD	27"	28 1/2"	16"	16"

Model	1	2	3	4	5	6
BMWD24DD	1370	1370	1370	1370	1370	1370
BMWD27DD	1494	1494	1494	1494	1494	1497
BMWD30DD	1686	1686	1686	1686	1686	1699

- Matching Interior Plywood (MIP) standard.
- Reinforced plywood floor.
- The usable cabinet face height between top of drawer front and top of cabinet is 19 1/8" for partial overlay and 18 3/8" for full overlay. Be sure to verify overall appliance height, gap requirements, and cut-out dimensions with cabinet specifications.

Model	7	8	9	10	11	12	13	14	15	16	17	18
BBMWD24	1362	1327	1333	1378	1389	1416	1470	1475	1533	1574	1636	1703
BBMWD27	1621	1577	1587	1641	1655	1687	1750	1758	1829	1877	1952	2031
BBMWD30	1632	1588	1597	1651	1665	1697	1760	1768	1839	1887	1962	2041

**Custom Modifications**

AUTHL	AUTHR	CBO	CCO	CFNTO	CFP	CFRMO	CMAT	CND	DRT	DRWPWR	DRWSEC	DRWTK	EXBKL	EXBKR	EXL	EXR	FB	FFDL	FPEB	FTK	FTKAV	FTKRV	ID	INVFRM	LTI	MIP	P	PTOWB	RD	RECTKALL	RECTKLBK	RECTKL	RECTKR	RT	SCPRDR	TD	TOTSSS	TVRAV	TVRFV	TVRVV	VTK	WLU	
•	•	•				•						•	•	•	•					•	•	•				•			•	•	•										•		

**Construction Upgrades**

APC	ET	PE
•		•

**Door Options**

CG	DPSRR

Model	1	2	3	4	5	6	7	8	9	10	11	12	13	14	15	16	17	18
BMWD24	1432	1397	1403	1451	1462	1491	1548	1553	1614	1657	1722	1793						
BMWD27	1571	1528	1537	1589	1602	1632	1692	1699	1767	1812	1886	1960						
BMWD30	1718	1670	1681	1739	1752	1786	1853	1860	1936	1986	2065	2148						

**Custom Modifications**

AUTHL	AUTHR	CBO	CCO	CFNTO	CFP	CFRMO	CMAT	CND	DRT	DRWPWR	DRWSEC	DRWTK	EXBKL	EXBKR	EXL	EXR	FB	FFDL	FPEB	FTK	FTKAV	FTKRV	ID	INVFRM	LTI	MIP	P	PTOWB	RD	RECTKALL	RECTKLBK	RECTKL	RECTKR	RT	SCPRDR	TD	TOTSSS	TVRAV	TVRFV	TVRVV	VTK	WLU	
•	•	•				•						•	•	•	•					•	•	•				STD			•	•	•										•		

**Construction Upgrades**

APC	ET	PE

**Door Options**

CG	DPSRR

Model	1	2	3	4	5	6	7	8	9	10	11	12	13	14	15	16	17	18
BMWD24DD	1432	1397	1403	1451	1462	1491	1548	1553	1614	1657	1722	1793						
BMWD27DD	1571	1528	1537	1589	1602	1632	1692	1699	1767	1812	1886	1960						
BMWD30DD	1780	1732	1742	1800	1813	1847	1914	1922	1997	2047	2127	2209						

**Custom Modifications**

AUTHL	AUTHR	CBO	CCO	CFNTO	CFP	CFRMO	CMAT	CND	DRT	DRWPWR	DRWSEC	DRWTK	EXBKL	EXBKR	EXL	EXR	FB	FFDL	FPEB	FTK	FTKAV	FTKRV	ID	INVFRM	LTI	MIP	P	PTOWB	RD	RECTKALL	RECTKLBK	RECTKL	RECTKR	RT	SCPRDR	TD	TOTSSS	TVRAV	TVRFV	TVRVV	VTK	WLU	
•	•	•				•						•	•	•	•					•	•	•				STD			•	•	•										•		

**Construction Upgrades**

APC	ET	PE

**Door Options**

CG	DPSRR

**BASE MICROWAVE CABINET, SINGLE or DOUBLE DOOR, 46 1/2" HIGH**

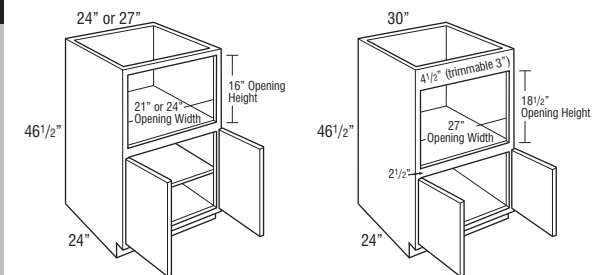
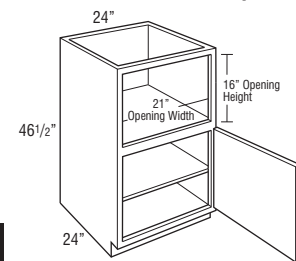

Model	Opening Width	Maximum Width	Opening Height	Maximum Height
BMW2448 L or R	21"	22 1/2"	16"	16"
BMW2448	21"	22 1/2"	16"	16"
BMW2748	24"	25 1/2"	16"	16"
BMW3048	27"	28 1/2"	18 1/2"	21 1/2"

Model	1	2	3	4	5	6
<b>BMW2448 L or R</b>	1223	1223	1223	1223	1223	1322
<b>BMW2448</b>	1289	1289	1289	1289	1289	1392
<b>BMW2748</b>	1367	1367	1367	1367	1367	1477
<b>BMW3048</b>	1573	1573	1573	1573	1573	1697

- Matching Interior Plywood (MIP) standard.
- Reinforced plywood floor.

Model	7	8	9	10	11	12	13	14	15	16	17	18
<b>BMW2448 L or R</b>	1346	1350	1356	1405	1419	1447	1505	1512	1574	1617	1686	1752
<b>BMW2448</b>	1419	1423	1429	1480	1492	1522	1583	1593	1657	1702	1776	1845
<b>BMW2748</b>	1503	1506	1515	1568	1583	1616	1681	1687	1755	1806	1884	1958
<b>BMW3048</b>	1731	1735	1744	1804	1821	1856	1931	1941	2023	2079	2163	2251

**Custom Modifications**

AUTHL	AUTHR	CBO	CCO	CFNTD	CFP	CFRMO	CMT	CND	DRT	DRWPWR	DRWSEC	DRWTK	EXBKL	EXBKR	EXL	EXR	FB	FD	FFDL	FPEB	FTK	FTKAV	FTKRV	ID	INVFRM	LTI	MIP	P	PTOWB	RD	RECTKALL	RECTKLBK	RECTKL	RECTKR	RT	SCPDRW	TD	TOTSSS	TVRAV	TVRFV	TVRVV	VTK	WLI			
•	•	•	•	•	•	•	•	•	•	•	•	•	•	•	•	•	•	•	•	•	•	•	•	•	•	•	•	•	•	•	•	•	•	•	•	•	•	•	•	•	•	•	•	•	•	•

**Construction Upgrades**

APC	ET	PE
•	•	•

**Door Options**

CG	DPSRR
•	•

**BASE MICROWAVE CABINET with ROLL TRAY, 46 1/2" HIGH**

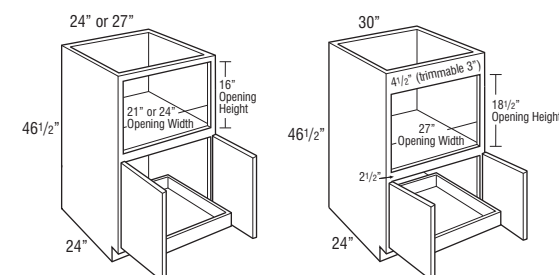
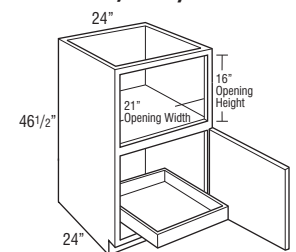

Model	Opening Width	Maximum Width	Opening Height	Maximum Height
BMW2448RT L or R	21"	22 1/2"	16"	16"
BMW2448RT	21"	22 1/2"	16"	16"
BMW2748RT	24"	25 1/2"	16"	16"
BMW3048RT	27"	28 1/2"	18 1/2"	21 1/2"

Model	1	2	3	4	5	6
<b>BMW2448RT L or R</b>	1592	1592	1592	1592	1592	1607
<b>BMW2448RT</b>	1668	1668	1668	1668	1668	1686
<b>BMW2748RT</b>	1766	1766	1766	1766	1766	1791
<b>BMW3048RT</b>	2001	2001	2001	2001	2001	2042

- Matching Interior Plywood (MIP) standard.
- Reinforced plywood floor.

Model	7	8	9	10	11	12	13	14	15	16	17	18
<b>BMW2448RT L or R</b>	1685	1640	1649	1703	1717	1750	1813	1825	1896	1945	2020	2097
<b>BMW2448RT</b>	1768	1720	1729	1787	1802	1837	1906	1913	1989	2042	2122	2202
<b>BMW2748RT</b>	1875	1827	1836	1897	1912	1950	2026	2033	2112	2170	2256	2339
<b>BMW3048RT</b>	2143	2084	2095	2163	2184	2228	2313	2321	2415	2479	2579	2675

**Custom Modifications**

AUTHL	AUTHR	CBO	CCO	CFNTD	CFP	CFRMO	CMT	CND	DRT	DRWPWR	DRWSEC	DRWTK	EXBKL	EXBKR	EXL	EXR	FB	FD	FFDL	FPEB	FTK	FTKAV	FTKRV	ID	INVFRM	LTI	MIP	P	PTOWB	RD	RECTKALL	RECTKLBK	RECTKL	RECTKR	RT	SCPDRW	TD	TOTSSS	TVRAV	TVRFV	TVRVV	VTK	WLI			
•	•	•	•	•	•	•	•	•	•	•	•	•	•	•	•	•	•	•	•	•	•	•	•	•	•	•	•	•	•	•	•	•	•	•	•	•	•	•	•	•	•	•	•	•	•	•

**Construction Upgrades**

APC	ET	PE
•	•	•

**Door Options**

CG	DPSRR
•	•



**BASE CORNER PENINSULA**

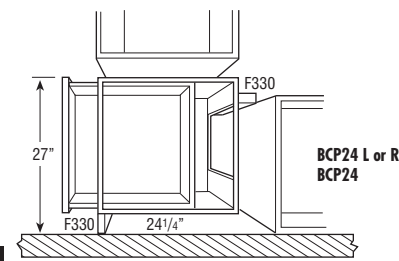

Model	1	2	3	4	5	6
<b>BCP24 L or R</b>	1335	1396	1600	1690	1614	1692
<b>BCP24</b>	1405	1470	1684	1778	1699	1782

- Cabinet width is 24".
- Adjustable full depth shelf.
- Includes two 3" fillers, shipped unattached. Fillers are required for drawer and door opening clearance of adjacent cabinets.
- Unfinished toekick on front (B24) and back (BCP) of cabinet.
- Will not accept roll trays.
- Peninsula base cabinets are 1/4" deeper to allow back paneling application on adjacent cabinets in a run with standard 24" deep cabinets.

Model	7	8	9	10	11	12	13	14	15	16	17	18
<b>BCP24 L or R</b>	1857	1787	1822	1890	1908	1944	2016	2028	2109	2162	2249	2339
<b>BCP24</b>	1955	1882	1917	1990	2007	2046	2125	2134	2220	2276	2367	2464

**Custom Modifications**

AUTHL	AUTHR	CBO	CCO	CFNTO	CFP	CFRMO	CMAT	CND	DRT	DRWPWR	DRWSEC	DRWTK	EXBKL	EXBKR	EXL	EXR	FB	FD	FFDL	FPEB	FTK	FTKAV	FTKFV	ID	INVFRM	LTI	MIP	P	PTOWB	RD	RECTKALL	RECTKBK	RECTKL	RECTKR	RT	SCPDWR	TD	TOTSSS	TVRAV	TVRFV	TVRVV	VTK	WLI				
•	•	•	•	•	•	•	•	•	•	•	•	•	•	•	•	•	•	•	•	•	•	•	•	•	•	•	•	•	•	•	•	•	•	•	•	•	•	•	•	•	•	•	•	•	•	•	•

\*RECTKALL not available

**Construction Upgrades**

APC	ET	PE
•	•	•

**Door Options**

CG	DPSRR
•	•

Model	19	20	21	22	23	24	25	26	27	28	29	30
<b>BCP24FH L or R</b>	1559	1574	1606	1669	1685	1717	1789	1798	1871	1923	2000	2081
<b>BCP24FH</b>	1641	1657	1692	1756	1773	1807	1883	1892	1971	2024	2104	2189

**Custom Modifications**

AUTHL	AUTHR	CBO	CCO	CFNTO	CFP	CFRMO	CMAT	CND	DRT	DRWPWR	DRWSEC	DRWTK	EXBKL	EXBKR	EXL	EXR	FB	FD	FFDL	FPEB	FTK	FTKAV	FTKFV	ID	INVFRM	LTI	MIP	P	PTOWB	RD	RECTKALL	RECTKBK	RECTKL	RECTKR	RT	SCPDWR	TD	TOTSSS	TVRAV	TVRFV	TVRVV	VTK	WLI						
•	•	•	•	•	•	•	•	•	•	•	•	•	•	•	•	•	•	•	•	•	•	•	•	•	•	•	•	•	•	•	•	•	•	•	•	•	•	•	•	•	•	•	•	•	•	•	•	•	•

\*RECTKALL not available

**Construction Upgrades**

APC	ET	PE
•	•	•

**Door Options**

CG	DPSRR
•	•

**BASE CORNER PENINSULA with FULL HEIGHT DOOR**

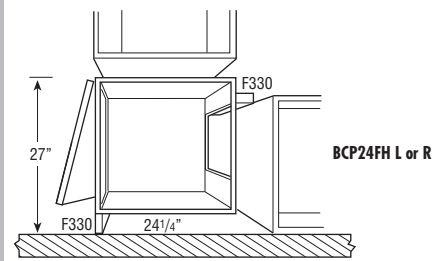

Model	1	2	3	4	5	6
<b>BCP24FH L or R</b>	1077	1136	1333	1417	1500	1487
<b>BCP24FH</b>	1134	1197	1403	1492	1578	1564

- Cabinet width is 24".
- Adjustable full depth shelf.
- Includes two 3" fillers, shipped unattached. Fillers are required for drawer and door opening clearance of adjacent cabinets.
- Unfinished toekick on front (B24) and back (BCP) of cabinet.
- Will not accept roll trays.
- Peninsula base cabinets are 1/4" deeper to allow back paneling application on adjacent cabinets in a run with standard 24" deep cabinets.

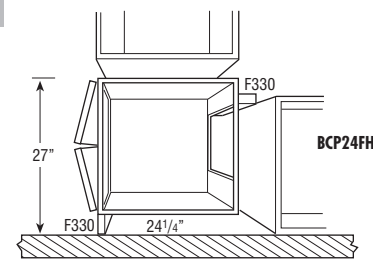

**BASE QUARTER ROUND END SHELF**

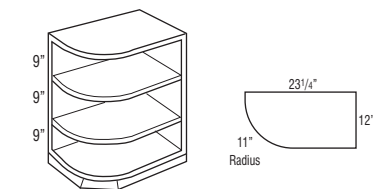

Model	1	2	3	4	5	6
<b>BQRES</b>	1059	1059	1059	1059	1059	1059

- Reversible.
- 12" wide x 23 1/4" deep x 11" radius.
- Separate pedestal base included.
- Angled pedestal design allows easier application of matching toeboard.
- Veneer construction finished to match cabinet face frame.
- Veneer on a 3/4" furniture board core.
- Matching interior.
- Cabinet is to be installed behind the face frame of the adjacent 24" deep base cabinet, features two unfinished back panels.
- If ordered with Heirlooming Technique, will not feature sand-through characteristics.

Model	7	8	9	10	11	12	13	14	15	16	17	18
<b>BQRES</b>	1059	1059	1059	1059	1059	1059	1059	1059	1059	1059	1059	1059

MODIFICATIONS
No modifications available for these products.

**Construction Upgrades**

APC	ET	PE
•	•	•



## UNIVERSAL ACCESS NOMENCLATURE

All Universal Access Cabinets are 32 1/2" high unless otherwise noted.

**B2432.5**

Cabinet Type Cabinet Width

## MODIFICATIONS GRID KEY

- Available Standard on these cabinets
- 5 DAY** 5 Day Express Response Item

## CUSTOM MODIFICATIONS

Mod.	Description	Mod.	Description
ACS	Appliance Cut-out, Single	EXL	Extended Stile - Left
CBO	Cabinet Box Only	EXR	Extended Stile - Right
CCO	Cabinet Case Only	FB	Finished Ends
CFNTO	Cabinet Front Only	FD	Full Depth Shelf
CFP	Cabinet False Panel	FPFB	Furniture Finished Plywood Ends
CFRMO	Cabinet Frame Only	ID	Increased Depth
CMAT	CabMat™	LTI	Light Installed Battery Strip
CND	Cabinet with No Door, with Drawer	MIP	Matching Interior Plywood
DRT	Deep Roll Tray	RD	Reduced Depth
DRWPWR	PowerGlide™ Compact Drawer Outlet	RT	Installed Roll Tray
DRWSEC	Biometric Secured Drawer	SCPDRW	Scooped Drawer
EXBKL	End Extended Back - Left	TOTSSS	Tilt-out Tray, Stainless Steel Slim
EXBKR	End Extended Back - Right	VTK	Void Toekick
		WLI	White Laminate Interior

## CONSTRUCTION UPGRADES

Mod.	Description
APC	All-plywood Construction
PE	Plywood Ends

## DOOR OPTIONS

Mod.	Description
DPSRR	Door Panel - Solid Reverse Raised
MFO	Modified Full Overlay

### UNIVERSAL ACCESS BASE, SINGLE DOOR

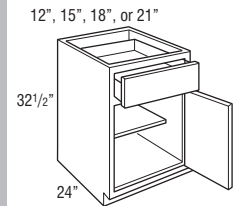

Model	1	2	3	4	5	6
<b>B1232.5 L or R</b>	721	755	817	860	870	882
<b>B1532.5 L or R</b>	762	794	866	913	913	928
<b>B1832.5 L or R</b>	786	826	889	940	959	980
<b>B2132.5 L or R</b>	827	870	951	1007	1031	1058

- Adjustable 15" deep shelf.

### UNIVERSAL ACCESS BASE, DOUBLE DOOR

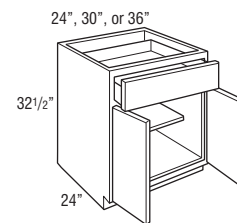

<b>B2432.5</b>	1001	1050	1154	1215	1215	1215
<b>B3032.5</b>	1077	1134	1268	1345	1371	1429
<b>B3632.5</b>	1126	1189	1333	1419	1462	1532

- Adjustable 15" deep shelf.

### UNIVERSAL ACCESS SINK BASE

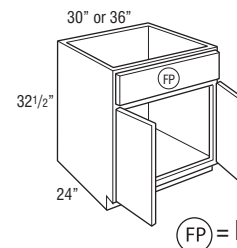

<b>SB3032.5</b>	763	813	920	988	1098	1155
<b>SB3632.5</b>	810	863	975	1042	1178	1245

- Mini Touch-up Kit (MTUK) included. MTUK includes small touch-up marker and small fill stick.

### UNIVERSAL ACCESS SINK BASE with TILT-OUT TRAYS

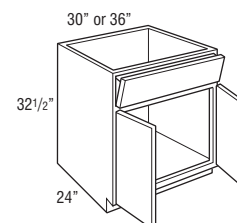

<b>SB3032.5ST</b>	1000	1065	1157	1241	1340	1400
<b>SB3632.5ST</b>	1050	1121	1214	1299	1419	1484

- Tilt-out trays are stain resistant, moisture resistant plastic to allow storage of sponges and other cleaning materials.
- Mini Touch-up Kit (MTUK) included. MTUK includes small touch-up marker and small fill stick.
- Includes two tilt-out trays.
- Tilt-out trays are also available as an accessory for field installation. See page 584.

Model	7	8	9	10	11	12	13	14	15	16	17	18
<b>B1232.5 L or R</b>	943	930	949	984	989	1008	1043	1049	1089	1118	1161	1205
<b>B1532.5 L or R</b>	1005	976	993	1034	1040	1058	1097	1101	1145	1173	1218	1267
<b>B1832.5 L or R</b>	1036	1035	1050	1091	1098	1119	1162	1165	1211	1245	1291	1342
<b>B2132.5 L or R</b>	1107	1117	1137	1179	1188	1211	1255	1262	1310	1342	1395	1451

#### Custom Modifications

ACS	CBO	CCO	CFNTO	CFP	CFRMO	CMAT	CND	DRT	DRWPWR	DRWSEC	EXBKL EXBKR	EXL EXR	FB	FD	FPFB	ID	LTI	MIP	RD	RT	SCPDRW	TOTSSS	VTK	WLI
•	•	•	•	•	•	•	•	•	•*	•*	•	•	•	•	•	•	•*	•	•	•	•	•	•	•

\*Not available on 12" and 15" wide

\*Not available on 12" wide

#### Construction Upgrades

APC	PE
•	•

#### Door Options

DPSRR	MFO
•	•

<b>B2432.5</b>	1336	1283	1308	1354	1367	1393	1446	1450	1507	1549	1607	1674
<b>B3032.5</b>	1480	1509	1540	1598	1607	1639	1700	1709	1778	1827	1897	1972
<b>B3632.5</b>	1559	1616	1647	1709	1724	1753	1826	1834	1903	1955	2035	2117

#### Custom Modifications

ACS	CBO	CCO	CFNTO	CFP	CFRMO	CMAT	CND	DRT	DRWPWR	DRWSEC	EXBKL EXBKR	EXL EXR	FB	FD	FPFB	ID	LTI	MIP	RD	RT	SCPDRW	TOTSSS	VTK	WLI
•	•	•	•	•	•	•	•	•	•	•*	•	•	•	•	•	•	•	•	•	•	•	•	•	•

\*Available only on 24" wide

#### Construction Upgrades

APC	PE
•	•

#### Door Options

DPSRR	MFO
•	•

<b>SB3032.5</b>	1086	1223	1249	1298	1308	1335	1388	1394	1452	1492	1552	1614
<b>SB3632.5</b>	1146	1316	1344	1397	1407	1442	1497	1503	1565	1606	1678	1744

#### Custom Modifications

ACS	CBO	CCO	CFNTO	CFP	CFRMO	CMAT	CND	DRT	DRWPWR	DRWSEC	EXBKL EXBKR	EXL EXR	FB	FD	FPFB	ID	LTI	MIP	RD	RT	SCPDRW	TOTSSS	VTK	WLI
•	•	•	•	•	•	•	•	•	•	•	•	•	•	•	•	•	•	•	•	•	•	•	•	•

#### Construction Upgrades

APC	PE
•	•

#### Door Options

DPSRR	MFO
•	•

<b>SB3032.5ST</b>	1364	1482	1515	1576	1589	1622	1685	1694	1766	1809	1886	1960
<b>SB3632.5ST</b>	1429	1576	1606	1670	1686	1719	1789	1798	1873	1924	2005	2086

#### Custom Modifications

ACS	CBO	CCO	CFNTO	CFP	CFRMO	CMAT	CND	DRT	DRWPWR	DRWSEC	EXBKL EXBKR	EXL EXR	FB	FD	FPFB	ID	LTI	MIP	RD	RT	SCPDRW	TOTSSS	VTK	WLI
•	•	•	•	•	•	•	•	•	•	•	•	•	•	•	•	•	•	•	•	•	•	•	•	•

#### Construction Upgrades

APC	PE
•	•

#### Door Options

DPSRR	MFO
•	•

**NEW** UNIVERSAL ACCESS SUPER LAZY SUSAN

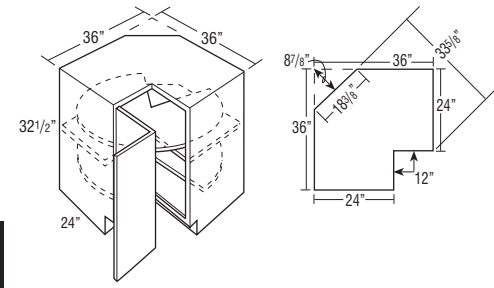

Due to fixed shelf mounting, shelves cannot be retrofitted.

Model	1	2	3	4	5	6
<b>SLS3632.5 L or R</b>	1634	1741	1918	2035	2873	2992

- SLS3632.5 L or R wall width is 36" x 36".
- Features two plywood revolving shelves with a 1" plywood lip. Lower shelf is mounted to floor. Upper shelf is mounted to fixed shelf. Fixed shelf is 1/2" thick laminated furniture board.
- Decorative hardware screws must be countersunk to prevent scratching adjacent cabinets and face frame of SLS.
- Integrated soft-close hinge not included.

**NEW** UNIVERSAL ACCESS THREE DRAWER BASE

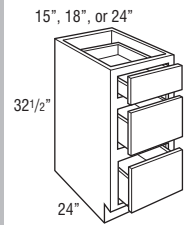

<b>3DB1532.5</b>	1420	1420	1420	1420	1423	1423
<b>3DB1832.5</b>	1476	1476	1476	1476	1502	1502
<b>3DB2432.5</b>	1620	1620	1620	1620	1636	1636

- 1 shallow and 2 deep drawers.

**NEW** UNIVERSAL ACCESS BASE MICROWAVE with DEEP DRAWER

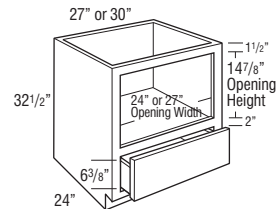

<b>BMW2732.5DD</b>	1690	1690	1690	1690	1690	1709
<b>BMW3032.5DD</b>	1775	1775	1775	1775	1775	1794

- 1 deep drawer below microwave.
- Matching Interior Plywood (MIP) standard.

**NEW** UNIVERSAL ACCESS DESK LEG

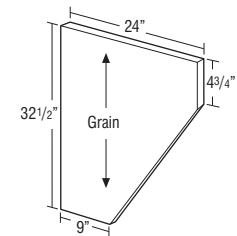

<b>VDL32.5WD</b>	217	217	217	217	217	217
------------------	-----	-----	-----	-----	-----	-----

- VDL32.5WD in Stains: 3/4" thick veneered furniture board.
- VDL32.5WD in Paints: 3/4" thick veneered or solid furniture board.
- All panels are finished two sides and front edge.

Model	7	8	9	10	11	12	13	14	15	16	17	18
<b>SLS3632.5 L or R</b>	2236	3173	3232	3362	3394	3459	3597	3619	3771	3866	4029	4187

Custom Modifications

ACS	CBO	CCO	CFNTO	CFP	CFRMO	CMAT	CND	DRT	DRWPWR	DRWSEC	EXBKL EXBKR	EXL EXR	FB	FD	FPEB	ID	LTI	MIP	RD	RT	SCPDRW	TOTSSS	VTK	WLI	
•	•												•		•			•	•					•	•

Construction Upgrades

APC	PE
•	•

Door Options

DPSRR	MFO
•	

<b>3DB1532.5</b>	1560	1490	1513	1563	1575	1602	1656	1659	1718	1757	1824	1896
<b>3DB1832.5</b>	1623	1574	1601	1655	1665	1694	1751	1755	1821	1864	1931	2009
<b>3DB2432.5</b>	1783	1721	1751	1811	1829	1857	1923	1931	2002	2051	2128	2213

Custom Modifications

ACS	CBO	CCO	CFNTO	CFP	CFRMO	CMAT	CND	DRT	DRWPWR	DRWSEC	EXBKL EXBKR	EXL EXR	FB	FD	FPEB	ID	LTI	MIP	RD	RT	SCPDRW	TOTSSS	VTK	WLI	
•	•				•	•			•*	•*	•	•	•		•						•			•	

\*Not available on 15" wide

Construction Upgrades

APC	PE
•	•

Door Options

DPSRR	MFO

<b>BMW2732.5DD</b>	1794	1744	1751	1810	1831	1861	1932	1943	2016	2075	2154	2242
<b>BMW3032.5DD</b>	1884	1831	1839	1901	1923	1954	2029	2040	2117	2179	2262	2354

Custom Modifications

ACS	CBO	CCO	CFNTO	CFP	CFRMO	CMAT	CND	DRT	DRWPWR	DRWSEC	EXBKL EXBKR	EXL EXR	FB	FD	FPEB	ID	LTI	MIP	RD	RT	SCPDRW	TOTSSS	VTK	WLI
•	•				•						•	•			•								•	

Construction Upgrades

APC	PE

Door Options

DPSRR	MFO

<b>VDL32.5WD</b>	217	217	217	217	217	217	217	217	217	217	217	217
------------------	-----	-----	-----	-----	-----	-----	-----	-----	-----	-----	-----	-----

MODIFICATIONS
No modifications available for these products.

Finish Techniques

Distressing	Heirlooming

Species Availability (Wood)

Alder	Rustic Alder	Cherry	Rustic Hickory	Maple	Oak
•	•	•	•	•	•

Species Availability (All Laminates)

High Gloss box color	Horiz. Grain on Maple box color	Vert. Grain on Maple box color	Vert. Grain on Cherry box color	Vert. Grain on Oak box color

**VANITY WALL SINK**

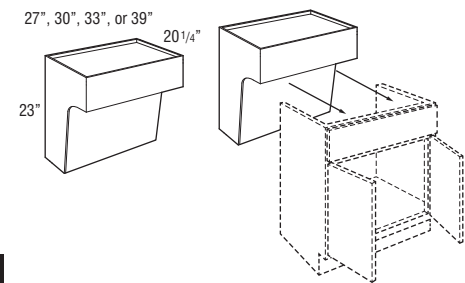

Model	1	2	3	4	5	6
<b>VWS2723</b>	965	965	965	965	965	965
<b>VWS3023</b>	982	982	982	982	982	982
<b>VWS3323</b>	999	999	999	999	999	999
<b>VWS3923</b>	1034	1034	1034	1034	1034	1034

- Matching Interior Plywood (MIP) standard.
- Recommended installation height of 32" high with 9" of clearance below.
- Front panel is attached with clips for easy removal for access to plumbing.
- Finished veneer plywood exterior and interior.
- For proper installation, cabinet must be secured on each side through both the top and bottom of the back panel into wall studs. Installation instructions and required 3 1/2" installation screws included, standard 2 1/2" installation screws are not sufficient in this application.
- Features a full cabinet top that can be routed for sink installation.
- Approximate weight limit is 400 lbs. per cabinet (includes weight of the cabinet, countertop and contents). Proper installation is required and additional bracing may be required.
- Includes connector clips to mount the sink base to the Removable Vanity Sink Base (RVWS..32). RVWS..32 not included, see below.

**REMOVABLE VANITY SINK BASE, 21" DEEP**

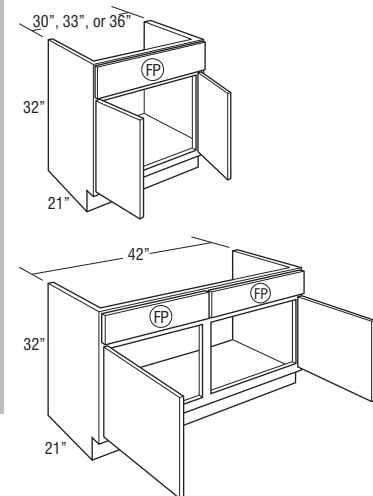

<b>RVWS3032</b>	816	870	992	1115	1189	1249
<b>RVWS3332</b>	845	901	1006	1138	1220	1283
<b>RVWS3632</b>	877	933	1019	1172	1247	1312
<b>RVWS4232</b>	994	1061	1093	1302	1336	1410

- Must be ordered with Vanity Wall Sink (VWS..23), not designed to be a stand-alone unit.
  - RVWS3032 is compatible with VWS2723
  - RVWS3332 is compatible with VWS3023
  - RVWS3632 is compatible with VWS3323
  - RVWS4232 is compatible with VWS3923
- Cabinet is able to be removed for handicap accessible use.
- Includes connector clips to mount the sink base to the Vanity Wall Sink (VWS..23).
- Available with AUTHL and AUTHR modifications.

Model	7	8	9	10	11	12	13	14	15	16	17	18
<b>VWS2723</b>	965	965	965	965	965	965	965	965	965	965	965	965
<b>VWS3023</b>	982	982	982	982	982	982	982	982	982	982	982	982
<b>VWS3323</b>	999	999	999	999	999	999	999	999	999	999	999	999
<b>VWS3923</b>	1034	1034	1034	1034	1034	1034	1034	1034	1034	1034	1034	1034

**Custom Modifications**

ACS	CBO	CCO	CFNTO	CFP	CFRMO	CMAT	CND	DRT	DRWPWR	DRWSEC	EXBKL EXBKR	EXL EXR	FB	FD	FPEB STD	ID	LTI	MIP	RD	RT	SCPRDW	TOTSSS	VTK	WLI

**Construction Upgrades**

APC	PE

**Door Options**

DPSRR	MFO

<b>RVWS3032</b>	1223	1321	1350	1406	1416	1447	1507	1512	1576	1620	1686	1752
<b>RVWS3332</b>	1255	1361	1385	1442	1452	1486	1545	1549	1614	1660	1727	1800
<b>RVWS3632</b>	1291	1391	1420	1475	1488	1521	1580	1587	1652	1695	1766	1837
<b>RVWS4232</b>	1433	1494	1520	1582	1601	1629	1695	1705	1774	1820	1897	1975

**Custom Modifications**

ACS	CBO	CCO	CFNTO	CFP	CFRMO	CMAT	CND	DRT	DRWPWR	DRWSEC	EXBKL EXBKR	EXL EXR	FB	FD	FPEB STD	ID	LTI	MIP	RD	RT	SCPRDW	TOTSSS	VTK	WLI
		•	•	STD	•	•						•			STD		•	•					•	

**Construction Upgrades**

APC	PE
STD	

**Door Options**

DPSRR	MFO
•	

### TALL CABINET NOMENCLATURE

Cabinet nomenclature with AH represents upper sections with doors that align with 24" or 27" high cabinets.

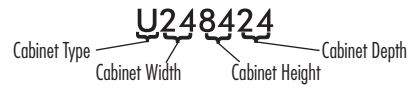

#### NOTE:

Any included shelves on tall cabinets are packaged separately.

### MODIFICATIONS GRID KEY

- Available
- STD Standard on these cabinets
- S Smart Solutions™ Organization Cabinet

### CUSTOM MODIFICATIONS

Mod.	Description	Mod.	Description	Mod.	Description
ACS	Appliance Cut-out, Single	EXBKR	End Extended Back - Right	ID	Increased Depth
ADDTK	Add Toekick	EXL	Extended Sile - Left	INVFRM	Inverted Frame
AUTHL	Authentic End - Left	EXR	Extended Sile - Right	MIP	Matching Interior Plywood
AUTHR	Authentic End - Right	FB	Finished Ends	RD	Reduced Depth
CBO	Cabinet Box Only	FD	Full Depth Shelf	RECTKL	Recessed Toekick - Left
CCO	Cabinet Case Only	FFDL	Face Frame and Door on End - Left	RECTKR	Recessed Toekick - Right
CFNTO	Cabinet Front Only	RT	Installed Roll Tray	TD	Tray Dividers
CFRMO	Cabinet Frame Only	FFDR	Face Frame and Door on End - Right	TKP	Loose Toekick
CND	Cabinet with No Door, with Drawer	FPEB	Furniture Finished Plywood Ends	VTK	Void Toekick
DRT	Deep Roll Tray	FTK	Flush Toekick	WLI	White Laminated Interior
DRWTK	Toekick Drawer	FTKAV	Flush Toekick Arch		
EXBKL	End Extended Back - Left	FTKAV	Flush Toekick Furniture		

### CONSTRUCTION UPGRADES

Mod.	Description
APC	All-plywood Construction
ET	EasyTrax™
PE	Plywood Ends

### DOOR OPTIONS

Mod.	Description
CG.TOP	Cur-For-glass Doors
DPSRR	Door Panel - Solid Reverse Raised
MFO	Modified Full Overlay

Model	7	8	9	10	11	12	13	14	15	16	17	18
<b>U96612 L or R</b>	1316	1363	1390	1444	1460	1486	1545	1555	1618	1663	1732	1802
<b>U126612 L or R</b>	1316	1363	1390	1444	1460	1486	1545	1555	1618	1663	1732	1802
<b>U156612 L or R</b>	1371	1419	1445	1507	1518	1547	1610	1618	1687	1732	1804	1877
<b>U186612 L or R</b>	1438	1511	1539	1604	1616	1650	1713	1721	1795	1843	1921	1997
<b>U216612 L or R</b>	1580	1661	1695	1762	1777	1812	1886	1892	1972	2028	2114	2196
<b>U246612 L or R</b>	1630	1752	1786	1856	1875	1913	1987	1995	2080	2138	2227	2314
<b>U246612</b>	1680	1841	1878	1949	1970	2009	2088	2099	2187	2246	2339	2435
<b>U276612</b>	1779	2066	2109	2191	2214	2255	2346	2357	2456	2520	2626	2729
<b>U306612</b>	1878	2291	2336	2433	2452	2499	2601	2614	2723	2796	2912	3028
<b>U336612</b>	2020	2461	2510	2612	2633	2687	2795	2809	2926	3007	3131	3254
<b>U336612</b>	2161	2632	2685	2792	2815	2871	2987	3002	3127	3213	3348	3480

#### Custom Modifications

ACS	ADDTK	AUTHL	AUTHR	CBO	CCO	CFNTO	CFRMO	CND	DRT	DRWTK	EXBKL	EXBKR	EXL	EXR	FB	FFDL	FPEB	FTK	FTKAV	FTKAV	ID	INVFRM	MIP	RD	RECTKL	RECTKR	RT	TD	TKP	VTK	WLI	

\*Not available on 9" and 12" wide

#### Construction Upgrades

APC	ET	PE

#### Door Options

CG.TOP	DPSRR	MFO

Model	7	8	9	10	11	12	13	14	15	16	17	18
<b>U96624 L or R</b>	1346	1442	1472	1530	1544	1575	1636	1647	1713	1760	1834	1909
<b>U126624 L or R</b>	1346	1442	1472	1530	1544	1575	1636	1647	1713	1760	1834	1909
<b>U156624 L or R</b>	1401	1501	1533	1595	1608	1643	1706	1713	1786	1835	1913	1988
<b>U186624 L or R</b>	1545	1630	1665	1732	1747	1781	1851	1861	1939	1992	2075	2156
<b>U216624 L or R</b>	1699	1796	1832	1905	1921	1960	2037	2048	2135	2192	2282	2374
<b>U246624 L or R</b>	1917	1913	1949	2028	2046	2086	2171	2181	2272	2334	2431	2530
<b>U246624</b>	2136	2030	2069	2150	2171	2216	2303	2312	2409	2476	2579	2681
<b>U276624</b>	2291	2277	2323	2416	2437	2487	2586	2597	2705	2779	2896	3011
<b>U306624</b>	2448	2528	2577	2680	2702	2758	2868	2881	3002	3083	3211	3339
<b>U336624</b>	2633	2714	2768	2879	2903	2964	3082	3094	3224	3314	3450	3587
<b>U336624</b>	2816	2902	2961	3078	3104	3168	3293	3308	3445	3542	3688	3838

#### Custom Modifications

ACS	ADDTK	AUTHL	AUTHR	CBO	CCO	CFNTO	CFRMO	CND	DRT	DRWTK	EXBKL	EXBKR	EXL	EXR	FB	FFDL	FPEB	FTK	FTKAV	FTKAV	ID	INVFRM	MIP	RD	RECTKL	RECTKR	RT	TD	TKP	VTK	WLI

\*Not available on 9", 12", and 15" wide

\*Not available on 9" and 12" wide

\*Not available on 9" wide

#### Construction Upgrades

APC	ET	PE

#### Door Options

CG.TOP	DPSRR	MFO

### NEW UTILITY, 66" TALL, 12" DEEP

9", 12", 15", 18", 21", or 24"

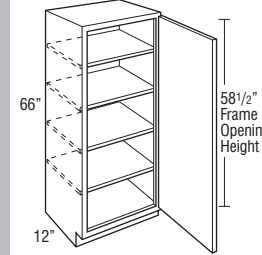

**U96612 L or R**  
**U126612 L or R**  
**U156612 L or R**  
**U186612 L or R**  
**U216612 L or R**  
**U246612 L or R**

24", 27", 30", 33", or 36"

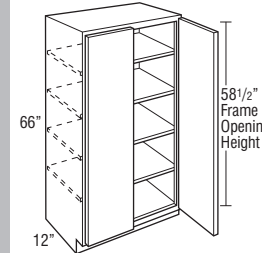

**U246612**  
**U276612**  
**U306612**  
**U336612**  
**U366612**

Model	1	2	3	4	5	6
<b>U96612 L or R</b>	807	862	1018	1197	1225	1285
<b>U126612 L or R</b>	807	862	1018	1197	1225	1285
<b>U156612 L or R</b>	841	895	1058	1248	1276	1339
<b>U186612 L or R</b>	887	944	1118	1307	1357	1425
<b>U216612 L or R</b>	976	1040	1229	1439	1493	1569
<b>U246612 L or R</b>	1045	1103	1287	1484	1650	1652
<b>U246612</b>	1110	1170	1346	1527	1804	1735
<b>U276612</b>	1148	1214	1414	1617	1927	1949
<b>U306612</b>	1185	1259	1480	1707	2049	2162
<b>U336612</b>	1277	1355	1591	1836	2204	2323
<b>U366612</b>	1364	1449	1704	1964	2359	2483

- Recommended for stacking with wall cabinets to create tall utility cabinets for designs greater than 96".
- Utility cabinets with depths of 12" or less must be installed to wall studs or onto the end of another tall cabinet.
- Depth can be reduced to a minimum of 6". For depths of 6"-8", cabinet will not include toekick/pedestal.
- Tall non-mitered doors will have two center panels with cross rail.
- Derazi doors greater than 48" high will be two doors doweled together.
- Because of exposed seam when stacking, FPEB is not recommended.
- Be sure to use an end panel skin to connect the seam on the side of the stacked cabinets.

### NEW UTILITY, 66" TALL, 24" DEEP

9", 12", 15", 18", 21", or 24"

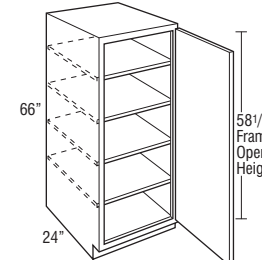

**U96624 L or R**  
**U126624 L or R**  
**U156624 L or R**  
**U186624 L or R**  
**U216624 L or R**  
**U246624 L or R**

24", 27", 30", 33", or 36"

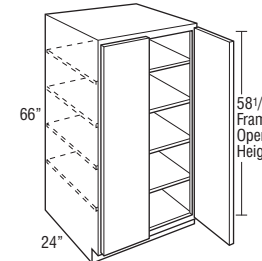

**U246624**  
**U276624**  
**U306624**  
**U336624**  
**U366624**

Model	1	2	3	4	5	6
<b>U96624 L or R</b>	820	871	1051	1225	1299	1361
<b>U126624 L or R</b>	820	871	1051	1225	1299	1361
<b>U156624 L or R</b>	854	909	1095	1276	1353	1418
<b>U186624 L or R</b>	956	1019	1206	1404	1464	1538
<b>U216624 L or R</b>	1051	1121	1326	1545	1613	1694
<b>U246624 L or R</b>	1252	1328	1512	1744	1795	1804
<b>U246624</b>	1452	1536	1696	1941	1976	1914
<b>U276624</b>	1533	1625	1806	2084	2120	2148
<b>U306624</b>	1614	1716	1917	2225	2266	2382
<b>U336624</b>	1733	1846	2062	2393	2437	2559
<b>U366624</b>	1853	1978	2202	2559	2607	2738

- Recommended for stacking with wall cabinets to create tall utility cabinets for designs greater than 96".
- Depth can be reduced to a minimum of 6". For depths of 6"-8", cabinet will not include toekick/pedestal.
- Tall non-mitered doors will have two center panels with cross rail.
- Derazi doors greater than 48" high will be two doors doweled together.
- Because of exposed seam when stacking, FPEB is not recommended.
- Be sure to use an end panel skin to connect the seam on the side of the stacked cabinets.

**UTILITY, 84", 87", 90", 93", or 96" TALL, 12" DEEP**

9", 12", 15", 18", 21", or 24"

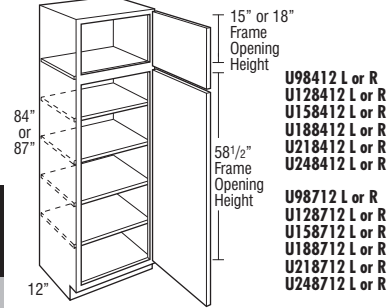

24", 27", 30", 33", or 36"

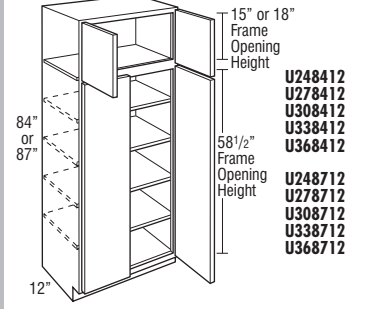

Model	1	2	3	4	5	6
<b>U98412 L or R</b>	897	958	1131	1330	1361	1428
<b>U128412 L or R</b>	897	958	1131	1330	1361	1428
<b>U158412 L or R</b>	934	994	1176	1387	1418	1488
<b>U188412 L or R</b>	986	1049	1242	1452	1508	1583
<b>U218412 L or R</b>	1084	1155	1366	1599	1659	1743
<b>U248412 L or R</b>	1161	1226	1430	1649	1833	1836
<b>U248412</b>	1233	1300	1496	1697	2004	1928
<b>U278412</b>	1275	1349	1571	1797	2141	2165
<b>U308412</b>	1317	1399	1644	1897	2277	2402
<b>U338412</b>	1419	1506	1768	2040	2449	2581
<b>U368412</b>	1515	1610	1893	2182	2621	2759

- Utility cabinets with depths of 12" or less must be installed to wall studs or onto the end of another tall cabinet.
- Depth can be reduced to a minimum of 6". For depths of 6"-8", cabinet will not include toekick/pedestal.
- Tall non-mitered doors will have two center panels with cross rail.
- Derazi doors greater than 48" high will be two doors doweled together.

<b>U98712 L or R</b>	932	992	1179	1349	1397	1465
<b>U128712 L or R</b>	932	992	1179	1349	1397	1465
<b>U158712 L or R</b>	971	1034	1228	1406	1455	1528
<b>U188712 L or R</b>	1022	1089	1293	1489	1546	1624
<b>U218712 L or R</b>	1125	1199	1423	1636	1700	1787
<b>U248712 L or R</b>	1196	1267	1479	1714	1870	1879
<b>U248712</b>	1264	1335	1537	1791	2040	1968
<b>U278712</b>	1363	1446	1681	1979	2270	2301
<b>U308712</b>	1354	1445	1693	2010	2326	2447
<b>U338712</b>	1457	1552	1821	2161	2499	2630
<b>U368712</b>	1559	1660	1949	2313	2674	2812

- Utility cabinets with depths of 12" or less must be installed to wall studs or onto the end of another tall cabinet.
- Depth can be reduced to a minimum of 6". For depths of 6"-8", cabinet will not include toekick/pedestal.
- Tall non-mitered doors will have two center panels with cross rail.
- Derazi doors greater than 48" high will be two doors doweled together.

Model	7	8	9	10	11	12	13	14	15	16	17	18
<b>U98412 L or R</b>	1462	1514	1544	1604	1622	1651	1717	1728	1798	1848	1924	2002
<b>U128412 L or R</b>	1462	1514	1544	1604	1622	1651	1717	1728	1798	1848	1924	2002
<b>U158412 L or R</b>	1523	1577	1606	1674	1687	1719	1789	1798	1874	1924	2004	2085
<b>U188412 L or R</b>	1598	1679	1710	1782	1795	1833	1903	1912	1994	2048	2134	2219
<b>U218412 L or R</b>	1756	1845	1883	1958	1974	2013	2095	2102	2191	2253	2349	2440
<b>U248412 L or R</b>	1811	1947	1984	2062	2083	2125	2208	2217	2311	2376	2474	2571
<b>U248412</b>	1867	2045	2087	2166	2189	2232	2320	2332	2430	2496	2599	2705
<b>U278412</b>	1977	2296	2343	2434	2460	2506	2607	2619	2729	2800	2918	3032
<b>U308412</b>	2087	2545	2596	2703	2724	2777	2890	2904	3026	3107	3235	3364
<b>U338412</b>	2244	2734	2789	2902	2926	2985	3105	3121	3251	3341	3479	3615
<b>U368412</b>	2401	2924	2983	3102	3128	3190	3319	3336	3474	3570	3720	3867

<b>U98712 L or R</b>	1487	1554	1586	1650	1665	1698	1766	1776	1848	1898	1978	2058
<b>U128712 L or R</b>	1487	1554	1586	1650	1665	1698	1766	1776	1848	1898	1978	2058
<b>U158712 L or R</b>	1548	1620	1652	1719	1735	1768	1839	1848	1926	1978	2059	2142
<b>U188712 L or R</b>	1636	1721	1753	1829	1842	1881	1954	1961	2045	2100	2189	2276
<b>U218712 L or R</b>	1800	1895	1930	2009	2027	2067	2150	2157	2249	2310	2409	2503
<b>U248712 L or R</b>	1886	1990	2029	2111	2130	2174	2259	2268	2364	2428	2530	2630
<b>U248712</b>	1970	2087	2127	2211	2233	2276	2368	2380	2478	2546	2652	2760
<b>U278712</b>	2179	2438	2487	2587	2611	2663	2768	2782	2898	2975	3101	3225
<b>U308712</b>	2211	2594	2646	2756	2777	2832	2946	2962	3083	3169	3299	3432
<b>U338712</b>	2379	2788	2843	2960	2984	3044	3166	3180	3313	3403	3546	3687
<b>U368712</b>	2543	2979	3042	3163	3189	3251	3382	3399	3541	3638	3791	3941

**Custom Modifications**

ACS	ADDTK	AUTHL AUTHR	CBO	CCO	CFNTO	CFRMO	CND	DRT	DRWTK	EXBKL EXBKR	EXL EXR	FB	FFDL FFDR	FPEB	FTK	FTKAV FTKRV	ID	INVFRM	MIP	RD	RECTKL RECTKR	RT	TD	TKP	VTK	WLI
		•	•	•	•	•				•	•	•	•	•	•	•*		•	•	•	•		•	•	•	•

\*Not available on 9" and 12" wide

**Construction Upgrades**

APC	ET	PE
•		•

**Door Options**

CG.TOP	DPSRR	MFO
•	•	•

**UTILITY, 84", 87", 90", 93", or 96" TALL, 12" DEEP (cont'd)**

9", 12", 15", 18", 21", or 24"

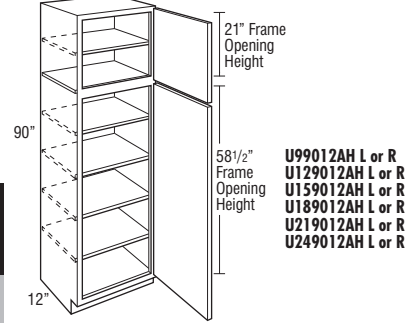

**U99012AH L or R**  
**U129012AH L or R**  
**U159012AH L or R**  
**U189012AH L or R**  
**U219012AH L or R**  
**U249012AH L or R**

24", 27", 30", 33", or 36"

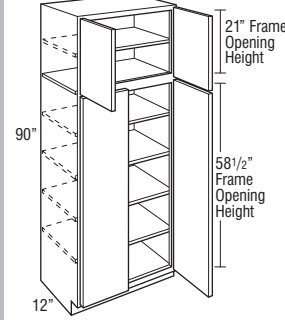

**U249012AH**  
**U279012AH**  
**U309012AH**  
**U339012AH**  
**U369012AH**

Model	1	2	3	4	5	6
<b>U99012AH L or R</b>	966	1029	1228	1371	1436	1504
<b>U129012AH L or R</b>	966	1029	1228	1371	1436	1504
<b>U159012AH L or R</b>	1008	1072	1280	1428	1494	1567
<b>U189012AH L or R</b>	1059	1130	1344	1521	1582	1664
<b>U219012AH L or R</b>	1166	1243	1479	1675	1742	1833
<b>U249012AH L or R</b>	1228	1305	1525	1778	1909	1919
<b>U249012AH</b>	1293	1370	1574	1882	2077	2006
<b>U279012AH</b>	1449	1540	1791	2161	2402	2435
<b>U309012AH</b>	1393	1489	1744	2125	2372	2494
<b>U339012AH</b>	1499	1599	1873	2284	2549	2680
<b>U369012AH</b>	1603	1709	2004	2441	2726	2865

- AH represents upper section alignment with doors on 24" or 27" high cabinets.
- Utility cabinets with depths of 12" or less must be installed to wall studs or onto the end of another tall cabinet.
- Depth can be reduced to a minimum of 6". For depths of 6"-8", cabinet will not include toekick/pedestal.
- Tall non-mitered doors will have two center panels with cross rail.
- Derazi doors greater than 48" high will be two doors doweled together.

Model	7	8	9	10	11	12	13	14	15	16	17	18
<b>U99012AH L or R</b>	1507	1596	1628	1694	1708	1745	1811	1824	1897	1950	2032	2114
<b>U129012AH L or R</b>	1507	1596	1628	1694	1708	1745	1811	1824	1897	1950	2032	2114
<b>U159012AH L or R</b>	1571	1662	1697	1766	1782	1815	1889	1897	1977	2032	2116	2201
<b>U189012AH L or R</b>	1675	1766	1798	1873	1889	1926	2004	2010	2096	2152	2243	2332
<b>U219012AH L or R</b>	1842	1944	1978	2059	2079	2122	2205	2211	2305	2367	2467	2564
<b>U249012AH L or R</b>	1956	2036	2074	2158	2178	2220	2308	2318	2417	2481	2586	2687
<b>U249012AH</b>	2070	2127	2166	2256	2275	2320	2415	2426	2527	2595	2706	2814
<b>U279012AH</b>	2379	2582	2634	2737	2764	2817	2929	2944	3067	3150	3283	3413
<b>U309012AH</b>	2336	2644	2696	2806	2830	2886	3001	3016	3141	3228	3361	3498
<b>U339012AH</b>	2512	2840	2898	3014	3042	3100	3224	3240	3375	3467	3610	3756
<b>U369012AH</b>	2686	3035	3099	3222	3249	3310	3445	3462	3606	3703	3860	4014

**Custom Modifications**

ACS	ADDTK	AUTHL AUTHR	CBO	CCO	CFNTO	CFRMO	CND	DRT	DRWTK	EXBKL EXBKR	EXL EXR	FB	FFDL	FPEB	FTK	FTKAV FTKFV	ID	INVERM	MIP	RD	RECTKL RECTKR	RT	TD	TKP	VTK	WLI
			•	•	•	•				•	•	•	•	•	•	•*		•	•	•	•		•	•	•	•

\*Not available on 9" and 12" wide

**Construction Upgrades**

APC	ET	PE
•		•

**Door Options**

CG.TOP	DPSRR	MFO
•	•	•



**UTILITY, 84", 87", 90", 93", or 96" TALL, 12" DEEP (cont'd)**

9", 12", 15", 18", 21", or 24"

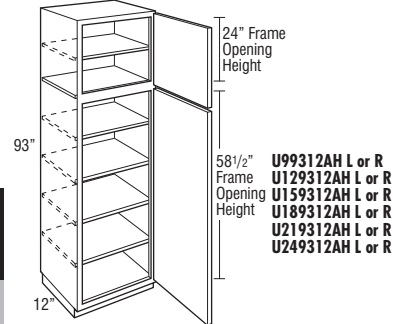

U99312AH L or R  
U129312AH L or R  
U159312AH L or R  
U189312AH L or R  
U219312AH L or R  
U249312AH L or R

24", 27", 30", 33", or 36"

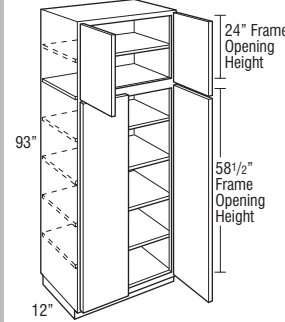

U249312AH  
U279312AH  
U309312AH  
U339312AH  
U369312AH

9", 12", 15", 18", 21", or 24"

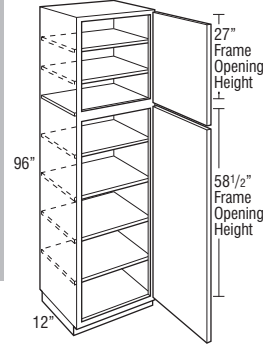

U99612 L or R  
U129612 L or R  
U159612 L or R  
U189612 L or R  
U219612 L or R  
U249612 L or R

24", 27", 30", 33", or 36"

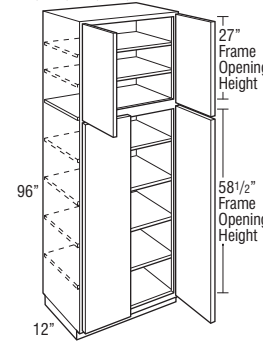

U249612  
U279612  
U309612  
U339612  
U369612

Model	1	2	3	4	5	6
U99312AH L or R	1035	1099	1329	1423	1509	1588
U129312AH L or R	1035	1099	1329	1423	1509	1588
U159312AH L or R	1078	1144	1385	1481	1574	1652
U189312AH L or R	1131	1203	1447	1596	1659	1744
U219312AH L or R	1245	1325	1593	1753	1827	1917
U249312AH L or R	1300	1381	1624	1898	1986	1999
U249312AH	1355	1436	1656	2041	2147	2077
U279312AH	1413	1503	1750	2183	2303	2333
U309312AH	1469	1567	1845	2326	2461	2589
U339312AH	1579	1686	1985	2501	2642	2780
U369312AH	1691	1802	2125	2675	2826	2970

- AH represents upper section alignment with doors on 24" or 27" high cabinets.
- Separate pedestal base included but packaged separately on 93" tall. Pedestal is designed to create a Recessed Left or Right Toekick application during field installation, or can be centered. Pedestal must be covered with toeboard material.
- Utility cabinets with depths of 12" or less must be installed to wall studs or onto the end of another tall cabinet.
- Depth can be reduced to a minimum of 6". For depths of 6"-8", cabinet will not include toekick/pedestal.
- Tall non-mitered doors will have two center panels with cross rail.
- Derazi doors greater than 48" high will be two doors doweled together.

U99612 L or R	1035	1099	1329	1423	1509	1588
U129612 L or R	1035	1099	1329	1423	1509	1588
U159612 L or R	1078	1144	1385	1481	1574	1652
U189612 L or R	1131	1203	1447	1596	1659	1744
U219612 L or R	1245	1325	1593	1753	1827	1917
U249612 L or R	1300	1381	1624	1898	1986	1999
U249612	1355	1436	1656	2041	2147	2077
U279612	1413	1503	1750	2183	2303	2333
U309612	1469	1567	1845	2326	2461	2589
U339612	1579	1686	1985	2501	2642	2780
U369612	1691	1802	2125	2675	2826	2970

- Separate pedestal base included but packaged separately on 96" tall. Pedestal is designed to create a Recessed Left or Right Toekick application during field installation, or can be centered. Pedestal must be covered with toeboard material.
- Utility cabinets with depths of 12" or less must be installed to wall studs or onto the end of another tall cabinet.
- Depth can be reduced to a minimum of 6". For depths of 6"-8", cabinet will not include toekick/pedestal.
- Tall non-mitered doors will have two center panels with cross rail.
- Derazi doors greater than 48" high will be two doors doweled together.

Model	7	8	9	10	11	12	13	14	15	16	17	18
U99312AH L or R	1564	1682	1714	1784	1798	1835	1907	1917	1999	2051	2138	2222
U129312AH L or R	1564	1682	1714	1784	1798	1835	1907	1917	1999	2051	2138	2222
U159312AH L or R	1631	1750	1786	1855	1874	1910	1986	1998	2081	2138	2228	2316
U189312AH L or R	1753	1848	1886	1959	1977	2013	2096	2105	2198	2253	2347	2439
U219312AH L or R	1928	2032	2075	2156	2176	2216	2305	2317	2416	2479	2582	2684
U249312AH L or R	2088	2117	2159	2246	2264	2308	2402	2415	2514	2583	2690	2795
U249312AH	2246	2201	2244	2334	2353	2401	2496	2509	2613	2684	2795	2910
U279312AH	2402	2471	2521	2621	2643	2696	2808	2818	2936	3016	3142	3268
U309312AH	2558	2740	2797	2910	2935	2995	3114	3127	3256	3347	3486	3627
U339312AH	2751	2946	3004	3124	3152	3216	3344	3357	3500	3596	3745	3895
U369312AH	2943	3148	3212	3341	3371	3435	3572	3593	3741	3842	4003	4163

U99612 L or R	1564	1682	1714	1784	1798	1835	1907	1917	1999	2051	2138	2222
U129612 L or R	1564	1682	1714	1784	1798	1835	1907	1917	1999	2051	2138	2222
U159612 L or R	1631	1750	1786	1855	1874	1910	1986	1998	2081	2138	2228	2316
U189612 L or R	1753	1848	1886	1959	1977	2013	2096	2105	2198	2253	2347	2439
U219612 L or R	1928	2032	2075	2156	2176	2216	2305	2317	2416	2479	2582	2684
U249612 L or R	2088	2117	2159	2246	2264	2308	2402	2415	2514	2583	2690	2795
U249612	2246	2201	2244	2334	2353	2401	2496	2509	2613	2684	2795	2910
U279612	2402	2471	2521	2621	2643	2696	2808	2818	2936	3016	3142	3268
U309612	2558	2740	2797	2910	2935	2995	3114	3127	3256	3347	3486	3627
U339612	2751	2946	3004	3124	3152	3216	3344	3357	3500	3596	3745	3895
U369612	2943	3148	3212	3341	3371	3435	3572	3593	3741	3842	4003	4163

**Custom Modifications**

ACS	ADDTK	AUTHL	AUTHR	CBO	CCO	CFNTO	CFRMO	CND	DRT	DRWTK	EXBKL	EXBKR	EXL	EXR	FB	FFDL	FFDR	FPEB	FTK	FTKAV	FTKRV	ID	INVFRM	MIP	RD	RECTKL	RECTKR	RT	TD	TKP	VTK	WLI	

**Construction Upgrades**

APC	ET	PE

**Door Options**

CG.TOP	DPSRR	MFO

**UTILITY, 84", 87", 90", 93", or 96" TALL, 24" DEEP**

9", 12", 15", 18", 21", or 24"

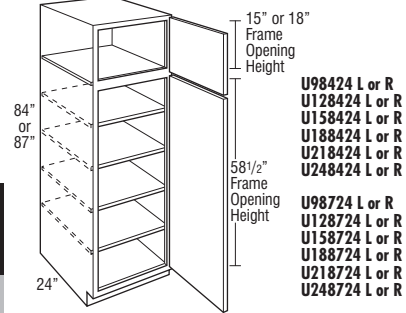

24", 27", 30", 33", or 36"

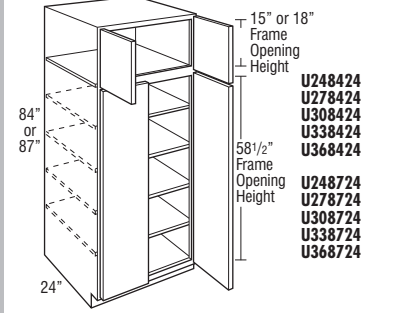

Model	1	2	3	4	5	6
U98424 L or R	911	968	1168	1361	1443	1512
U128424 L or R	911	968	1168	1361	1443	1512
U158424 L or R	949	1010	1217	1418	1503	1576
U188424 L or R	1062	1132	1340	1560	1627	1709
U218424 L or R	1168	1246	1473	1717	1792	1882
U248424 L or R	1391	1476	1680	1938	1994	2004
U248424	1613	1707	1884	2157	2196	2127
U278424	1703	1806	2007	2315	2356	2387
U308424	1793	1907	2130	2472	2518	2647
U338424	1925	2051	2291	2659	2708	2843
U368424	2059	2198	2447	2843	2897	3042

- Depth can be reduced to a minimum of 6". For depths of 6"-8", cabinet will not include toekick/pedestal.
- Tall non-mitered doors will have two center panels with cross rail.
- Derazi doors greater than 48" high will be two doors doweled together.

U98724 L or R	942	1006	1212	1384	1479	1552
U128724 L or R	942	1006	1212	1384	1479	1552
U158724 L or R	982	1047	1262	1442	1542	1618
U188724 L or R	1097	1170	1387	1596	1665	1748
U218724 L or R	1207	1287	1523	1754	1834	1923
U248724 L or R	1426	1513	1724	1997	2032	2043
U248724	1645	1741	1921	2234	2230	2162
U278724	1739	1845	2051	2402	2394	2430
U308724	1832	1950	2179	2567	2561	2694
U338724	1966	2096	2343	2763	2756	2895
U368724	2103	2244	2505	2955	2946	3093

- Depth can be reduced to a minimum of 6". For depths of 6"-8", cabinet will not include toekick/pedestal.
- Tall non-mitered doors will have two center panels with cross rail.
- Derazi doors greater than 48" high will be two doors doweled together.

Model	7	8	9	10	11	12	13	14	15	16	17	18
U98424 L or R	1496	1602	1635	1700	1715	1750	1818	1830	1903	1955	2038	2121
U128424 L or R	1496	1602	1635	1700	1715	1750	1818	1830	1903	1955	2038	2121
U158424 L or R	1557	1668	1703	1772	1787	1826	1896	1903	1984	2039	2125	2209
U188424 L or R	1717	1811	1850	1924	1941	1979	2057	2068	2154	2213	2305	2396
U218424 L or R	1888	1995	2035	2117	2134	2178	2263	2275	2372	2435	2536	2638
U248424 L or R	2130	2125	2166	2253	2273	2318	2412	2423	2524	2593	2701	2811
U248424	2373	2255	2299	2389	2412	2462	2559	2569	2677	2751	2866	2979
U278424	2546	2530	2581	2684	2708	2763	2873	2886	3005	3088	3218	3346
U308424	2720	2809	2863	2978	3002	3064	3187	3201	3336	3425	3568	3710
U338424	2925	3016	3075	3199	3226	3293	3424	3438	3582	3682	3833	3986
U368424	3129	3224	3290	3420	3449	3520	3659	3676	3828	3935	4098	4264

U98724 L or R	1522	1645	1680	1745	1760	1797	1865	1877	1954	2007	2091	2176
U128724 L or R	1522	1645	1680	1745	1760	1797	1865	1877	1954	2007	2091	2176
U158724 L or R	1586	1712	1748	1816	1835	1871	1947	1954	2037	2092	2180	2266
U188724 L or R	1754	1854	1892	1966	1984	2024	2102	2116	2203	2263	2356	2451
U218724 L or R	1928	2039	2081	2162	2182	2226	2314	2327	2423	2489	2592	2695
U248724 L or R	2170	2166	2210	2298	2318	2364	2461	2471	2575	2644	2756	2865
U248724	2411	2295	2338	2432	2453	2503	2605	2614	2724	2798	2915	3030
U278724	2618	2576	2625	2731	2756	2812	2924	2936	3058	3142	3274	3403
U308724	2824	2857	2914	3029	3055	3119	3243	3257	3394	3485	3632	3775
U338724	3038	3069	3130	3255	3283	3349	3483	3500	3645	3745	3899	4055
U368724	3251	3279	3346	3480	3508	3581	3722	3741	3895	4004	4169	4335

**Custom Modifications**

ACS	ADDTK	AUTHL	AUTHR	CBO	CCO	CFNTO	CFRMO	CND	DRT	DRWTK	EXBKL	EXBKR	EXL	EXR	FB	FFDL	FFDR	FPEB	FTK	FTKAV	FTKVV	ID	INVERM	MIP	RD	RECTKL	RECTKR	RT	TD	TKP	VTK	WLI	
										*											*												

\*Not available on 9", 12", and 15" wide    \*Not available on 9" and 12" wide    \*Not available on 9" wide

**Construction Upgrades**

APC	ET	PE

**Door Options**

CG.TOP	DPSRR	MFO

**UTILITY, 84", 87", 90", 93", or 96" TALL, 24" DEEP (cont'd)**

9", 12", 15", 18", 21", or 24"

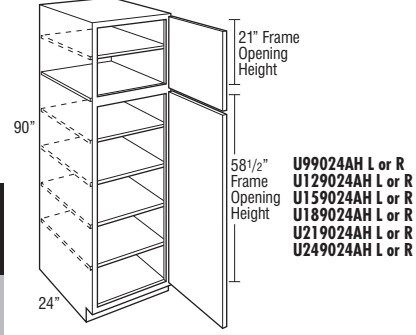

21" Frame Opening Height  
58 1/2" Frame Opening Height  
U99024AH L or R  
U129024AH L or R  
U159024AH L or R  
U189024AH L or R  
U219024AH L or R  
U249024AH L or R

24", 27", 30", 33", or 36"

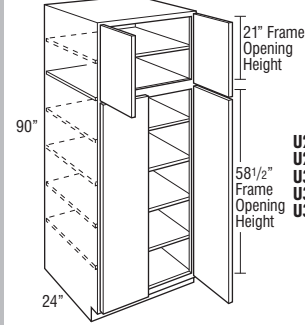

21" Frame Opening Height  
58 1/2" Frame Opening Height  
U249024AH  
U279024AH  
U309024AH  
U339024AH  
U369024AH

Model	1	2	3	4	5	6
<b>U99024AH L or R</b>	975	1041	1253	1406	1515	1594
<b>U129024AH L or R</b>	975	1041	1253	1406	1515	1594
<b>U159024AH L or R</b>	1016	1085	1305	1465	1578	1658
<b>U189024AH L or R</b>	1133	1209	1431	1628	1703	1787
<b>U219024AH L or R</b>	1247	1330	1575	1793	1874	1964
<b>U249024AH L or R</b>	1461	1551	1768	2052	2070	2083
<b>U249024AH</b>	1676	1772	1958	2311	2264	2201
<b>U279024AH</b>	1772	1883	2093	2487	2434	2470
<b>U309024AH</b>	1868	1991	2228	2665	2606	2738
<b>U339024AH</b>	2008	2141	2392	2866	2799	2944
<b>U369024AH</b>	2148	2292	2559	3065	2997	3146

- AH represents upper section alignment with doors on 24" or 27" high cabinets.
- Depth can be reduced to a minimum of 6". For depths of 6"-8", cabinet will not include toekick/pedestal.
- Tall non-mitered doors will have two center panels with cross rail.
- Derazi doors greater than 48" high will be two doors doweled together.

Model	7	8	9	10	11	12	13	14	15	16	17	18
<b>U99024AH L or R</b>	1549	1687	1721	1789	1805	1842	1913	1924	2004	2058	2144	2231
<b>U129024AH L or R</b>	1549	1687	1721	1789	1805	1842	1913	1924	2004	2058	2144	2231
<b>U159024AH L or R</b>	1613	1755	1793	1860	1883	1918	1995	2004	2088	2144	2234	2324
<b>U189024AH L or R</b>	1793	1895	1931	2008	2027	2067	2149	2159	2250	2311	2409	2505
<b>U219024AH L or R</b>	1971	2085	2126	2209	2230	2274	2363	2377	2474	2542	2647	2756
<b>U249024AH L or R</b>	2208	2209	2253	2339	2362	2411	2507	2518	2622	2694	2809	2918
<b>U249024AH</b>	2444	2333	2380	2472	2494	2545	2646	2659	2770	2847	2965	3082
<b>U279024AH</b>	2687	2619	2671	2777	2800	2859	2972	2986	3111	3196	3331	3461
<b>U309024AH</b>	2930	2904	2964	3081	3108	3172	3298	3311	3451	3545	3692	3839
<b>U339024AH</b>	3150	3121	3182	3309	3340	3404	3543	3558	3707	3807	3966	4124
<b>U369024AH</b>	3372	3336	3402	3538	3567	3638	3783	3805	3964	4069	4238	4408

**Custom Modifications**

ACS	ADDTK	AUTHL AUTHR	CBO	CCO	CFNTO	CFRMO	CND	DRT	DRWTK	EXBKL EXBKR	EXL EXR	FB	FFDL	FPEB	FTK	FTKAV FTKFV	ID	INVERM	MIP	RD	RECTKL RECTKR	RT	TD	TKP	VTK	WLI
			•	•	•	•			•*	•	•	•	•	•	•	•*	•	•	•	•	•	•*	•	•	•	•

\*Not available on 9", 12", and 15" wide    \*Not available on 9" and 12" wide    \*Not available on 9" wide

**Construction Upgrades**

APC	ET	PE
•		•

**Door Options**

CG.TOP	DPSRR	MFO
•	•	•

**UTILITY, 84", 87", 90", 93", or 96" TALL, 24" DEEP (cont'd)**

9", 12", 15", 18", 21", or 24"

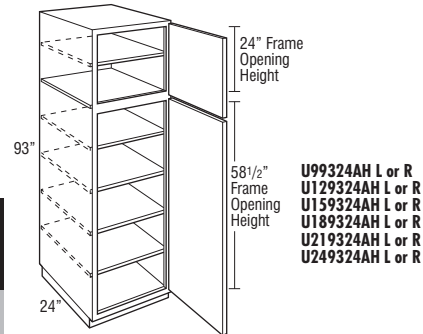

**U99324AH L or R**  
**U129324AH L or R**  
**U159324AH L or R**  
**U189324AH L or R**  
**U219324AH L or R**  
**U249324AH L or R**

24", 27", 30", 33", or 36"

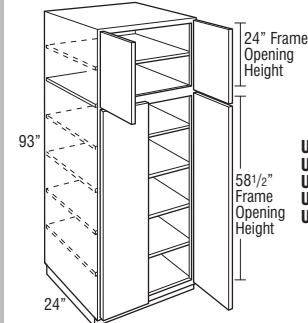

**U249324AH**  
**U279324AH**  
**U309324AH**  
**U339324AH**  
**U369324AH**

9", 12", 15", 18", 21", or 24"

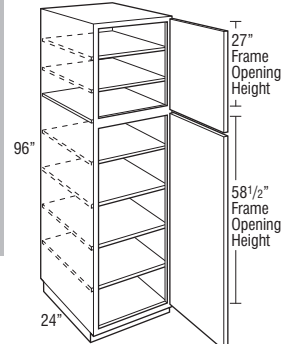

**U99624 L or R**  
**U129624 L or R**  
**U159624 L or R**  
**U189624 L or R**  
**U219624 L or R**  
**U249624 L or R**

24", 27", 30", 33", or 36"

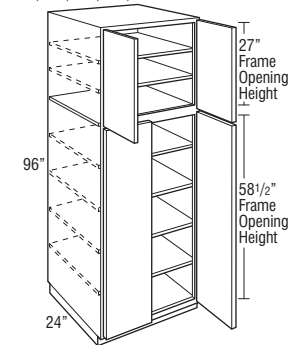

**U249624**  
**U279624**  
**U309624**  
**U339624**  
**U369624**

Model	1	2	3	4	5	6
<b>U99324AH L or R</b>	1043	1112	1341	1458	1593	1667
<b>U129324AH L or R</b>	1043	1112	1341	1458	1593	1667
<b>U159324AH L or R</b>	1087	1158	1395	1519	1657	1739
<b>U189324AH L or R</b>	1203	1280	1521	1700	1780	1860
<b>U219324AH L or R</b>	1325	1407	1675	1870	1956	2047
<b>U249324AH L or R</b>	1530	1624	1854	2168	2144	2158
<b>U249324AH</b>	1736	1838	2035	2465	2332	2267
<b>U279324AH</b>	1840	1956	2176	2660	2511	2548
<b>U309324AH</b>	1945	2074	2316	2854	2690	2827
<b>U339324AH</b>	2091	2229	2489	3070	2890	3037
<b>U369324AH</b>	2236	2383	2665	3284	3090	3246

- AH represents upper section alignment with doors on 24" or 27" high cabinets.
- Separate pedestal base included but packaged separately on 93" tall. Pedestal is designed to create a Recessed Left or Right Toekick application during field installation, or can be centered. Pedestal must be covered with toeboard material.
- Depth can be reduced to a minimum of 6". For depths of 6"-8", cabinet will not include toekick/pedestal.
- Tall non-mitered doors will have two center panels with cross rail.
- Derazi doors greater than 48" high will be two doors doweled together.

<b>U99624 L or R</b>	1043	1112	1341	1458	1593	1667
<b>U129624 L or R</b>	1043	1112	1341	1458	1593	1667
<b>U159624 L or R</b>	1087	1158	1395	1519	1657	1739
<b>U189624 L or R</b>	1203	1280	1521	1700	1780	1860
<b>U219624 L or R</b>	1325	1407	1675	1870	1956	2047
<b>U249624 L or R</b>	1530	1624	1854	2168	2144	2158
<b>U249624</b>	1736	1838	2035	2465	2332	2267
<b>U279624</b>	1840	1956	2176	2660	2511	2548
<b>U309624</b>	1945	2074	2316	2854	2690	2827
<b>U339624</b>	2091	2229	2489	3070	2890	3037
<b>U369624</b>	2236	2383	2665	3284	3090	3246

- Separate pedestal base included but packaged separately on 96" tall. Pedestal is designed to create a Recessed Left or Right Toekick application during field installation, or can be centered. Pedestal must be covered with toeboard material.
- Depth can be reduced to a minimum of 6". For depths of 6"-8", cabinet will not include toekick/pedestal.
- Tall non-mitered doors will have two center panels with cross rail.
- Derazi doors greater than 48" high will be two doors doweled together.

Model	7	8	9	10	11	12	13	14	15	16	17	18
<b>U99324AH L or R</b>	1604	1769	1804	1879	1894	1931	2007	2014	2100	2159	2250	2338
<b>U129324AH L or R</b>	1604	1769	1804	1879	1894	1931	2007	2014	2100	2159	2250	2338
<b>U159324AH L or R</b>	1670	1843	1882	1955	1973	2010	2092	2100	2189	2250	2344	2436
<b>U189324AH L or R</b>	1870	1975	2012	2095	2112	2154	2242	2252	2346	2410	2510	2611
<b>U219324AH L or R</b>	2058	2174	2215	2304	2324	2372	2466	2478	2581	2648	2762	2872
<b>U249324AH L or R</b>	2292	2289	2334	2427	2447	2497	2596	2611	2720	2791	2910	3025
<b>U249324AH</b>	2523	2404	2453	2550	2575	2623	2729	2742	2857	2935	3056	3179
<b>U279324AH</b>	2832	2701	2757	2866	2891	2948	3067	3081	3208	3297	3434	3571
<b>U309324AH</b>	3141	2997	3056	3178	3207	3273	3403	3420	3560	3658	3811	3964
<b>U339324AH</b>	3377	3219	3284	3413	3445	3513	3654	3674	3825	3929	4094	4258
<b>U369324AH</b>	3610	3438	3509	3648	3683	3754	3905	3925	4088	4198	4375	4550

<b>U99624 L or R</b>	1604	1769	1804	1879	1894	1931	2007	2014	2100	2159	2250	2338
<b>U129624 L or R</b>	1604	1769	1804	1879	1894	1931	2007	2014	2100	2159	2250	2338
<b>U159624 L or R</b>	1670	1843	1882	1955	1973	2010	2092	2100	2189	2250	2344	2436
<b>U189624 L or R</b>	1870	1975	2012	2095	2112	2154	2242	2252	2346	2410	2510	2611
<b>U219624 L or R</b>	2058	2174	2215	2304	2324	2372	2466	2478	2581	2648	2762	2872
<b>U249624 L or R</b>	2292	2289	2334	2427	2447	2497	2596	2611	2720	2791	2910	3025
<b>U249624</b>	2523	2404	2453	2550	2575	2623	2729	2742	2857	2935	3056	3179
<b>U279624</b>	2832	2701	2757	2866	2891	2948	3067	3081	3208	3297	3434	3571
<b>U309624</b>	3141	2997	3056	3178	3207	3273	3403	3420	3560	3658	3811	3964
<b>U339624</b>	3377	3219	3284	3413	3445	3513	3654	3674	3825	3929	4094	4258
<b>U369624</b>	3610	3438	3509	3648	3683	3754	3905	3925	4088	4198	4375	4550

**Custom Modifications**

ACS	ADDTK	AUTHL	AUTHR	CBO	CCO	CFNTO	CFRMO	CND	DRT	DRWTK	EXBKL	EXBKR	EXL	EXR	FB	FFDL	FFDR	FPEB	FTK	FTKAV	FTKRV	ID	INVFRM	MIP	RD	RECTKL	RECTKR	RT	TD	TKP	VTK	WLI	

\*Not available on 9" wide

**Construction Upgrades**

APC	ET	PE

**Door Options**

CG.TOP	DPSRR	MFO

**UTILITY with ROLL TRAYS,  
66" TALL, 24" DEEP**

12", 15", 18", 21", or 24"

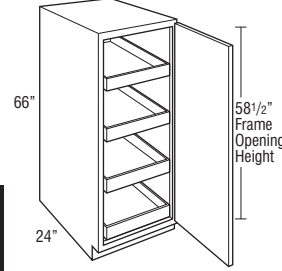

U126624RT L or R  
U156624RT L or R  
U186624RT L or R  
U216624RT L or R  
U246624RT L or R

24", 27", 30", 33", or 36"

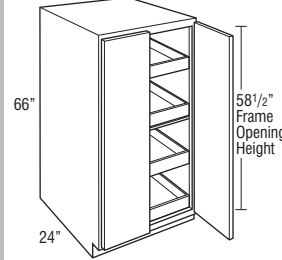

U246624RT  
U276624RT  
U306624RT  
U336624RT  
U366624RT

Model	1	2	3	4	5	6
U126624RT L or R	1956	2007	2187	2361	2435	2497
U156624RT L or R	1990	2045	2231	2412	2489	2554
U186624RT L or R	2092	2155	2342	2540	2600	2674
U216624RT L or R	2187	2257	2462	2681	2749	2830
U246624RT L or R	2388	2464	2648	2880	2931	2940
U246624RT	2588	2672	2832	3077	3112	3050
U276624RT	2669	2761	2942	3220	3256	3284
U306624RT	2750	2852	3053	3361	3402	3518
U336624RT	2869	2982	3198	3529	3573	3695
U366624RT	2989	3114	3338	3695	3743	3874

- Recommended for stacking with wall cabinets to create tall utility cabinets for designs greater than 96".
- Four roll trays are included, installed in cabinet.
- Depth can be reduced to a minimum of 12".
- Tall non-mitered doors will have two center panels with cross rail.
- Derazi doors greater than 48" high will be two doors doweled together.
- Because of exposed seam when stacking, FPEB is not recommended.
- Be sure to use an end panel skin to connect the seam on the side of the stacked cabinets.

Model	7	8	9	10	11	12	13	14	15	16	17	18
U126624RT L or R	2482	2578	2608	2666	2680	2711	2772	2783	2849	2896	2970	3045
U156624RT L or R	2537	2637	2669	2731	2744	2779	2842	2849	2922	2971	3049	3124
U186624RT L or R	2681	2766	2801	2868	2883	2917	2987	2997	3075	3128	3211	3292
U216624RT L or R	2835	2932	2968	3041	3057	3096	3173	3184	3271	3328	3418	3510
U246624RT L or R	3053	3049	3085	3164	3182	3222	3307	3317	3408	3470	3567	3666
U246624RT	3272	3166	3205	3286	3307	3352	3439	3448	3545	3612	3715	3817
U276624RT	3427	3413	3459	3552	3573	3623	3722	3733	3841	3915	4032	4147
U306624RT	3584	3664	3713	3816	3838	3894	4004	4017	4138	4219	4347	4475
U336624RT	3769	3850	3904	4015	4039	4100	4218	4230	4360	4450	4586	4723
U366624RT	3952	4038	4097	4214	4240	4304	4429	4444	4581	4678	4824	4974

**Custom Modifications**

ACS	ADDTK	AUTHL	AUTHR	CBO	CCO	CFNTO	CFRMO	CND	DRT	DRWTK	EXBKL	EXBKR	EXL	EXR	FB	FFDL	FFDR	FPEB	FTK	FTKAV	FTKFV	ID	INVFRM	MIP	RD	RECTKL	RECTKR	RT	TD	TKP	VTK	WLI	

\*Not available on 12" and 15" wide

**Construction Upgrades**

APC	ET	PE

**Door Options**

CG.TOP	DPSRR	MFO

**UTILITY with ROLL TRAYS, 84", 87", 90", 93", or 96" TALL, 24" DEEP**

12", 15", 18", 21", or 24"

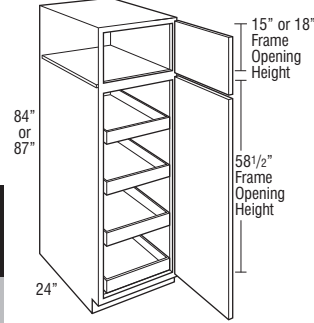

U128424RT L or R  
U158424RT L or R  
U188424RT L or R  
U218424RT L or R  
U248424RT L or R

U128724RT L or R  
U158724RT L or R  
U188724RT L or R  
U218724RT L or R  
U248724RT L or R

24", 27", 30", 33", or 36"

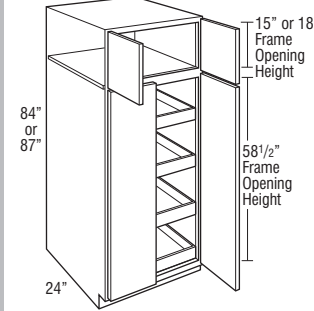

U248424RT  
U278424RT  
U308424RT  
U338424RT  
U368424RT

U248724RT  
U278724RT  
U308724RT  
U338724RT  
U368724RT

Model	1	2	3	4	5	6
U128424RT L or R	1977	2034	2234	2427	2509	2578
U158424RT L or R	2015	2076	2283	2484	2569	2642
U188424RT L or R	2128	2198	2406	2626	2693	2775
U218424RT L or R	2234	2312	2539	2783	2858	2948
U248424RT L or R	2457	2542	2746	3004	3060	3070
U248424RT	2679	2773	2950	3223	3262	3193
U278424RT	2769	2872	3073	3381	3422	3453
U308424RT	2859	2973	3196	3538	3584	3713
U338424RT	2991	3117	3357	3725	3774	3909
U368424RT	3125	3264	3513	3909	3963	4108

- Four roll trays are included, installed in cabinet.
- Depth can be reduced to a minimum of 12".
- Tall non-mitered doors will have two center panels with cross rail.
- Derazi doors greater than 48" high will be two doors doweled together.

U128724RT L or R	2008	2072	2278	2450	2545	2618
U158724RT L or R	2048	2113	2328	2508	2608	2684
U188724RT L or R	2163	2236	2453	2662	2731	2814
U218724RT L or R	2273	2353	2589	2820	2900	2989
U248724RT L or R	2492	2579	2790	3063	3098	3109
U248724RT	2711	2807	2987	3300	3296	3228
U278724RT	2805	2911	3117	3468	3460	3496
U308724RT	2898	3016	3245	3633	3627	3760
U338724RT	3032	3162	3409	3829	3822	3961
U368724RT	3169	3310	3571	4021	4012	4159

- Four roll trays are included, installed in cabinet.
- Depth can be reduced to a minimum of 12".
- Tall non-mitered doors will have two center panels with cross rail.
- Derazi doors greater than 48" high will be two doors doweled together.

Model	7	8	9	10	11	12	13	14	15	16	17	18
U128424RT L or R	2562	2668	2701	2766	2781	2816	2884	2896	2969	3021	3104	3187
U158424RT L or R	2623	2734	2769	2838	2853	2892	2962	2969	3050	3105	3191	3275
U188424RT L or R	2783	2877	2916	2990	3007	3045	3123	3134	3220	3279	3371	3462
U218424RT L or R	2954	3061	3101	3183	3200	3244	3329	3341	3438	3501	3602	3704
U248424RT L or R	3196	3191	3232	3319	3339	3384	3478	3489	3590	3659	3767	3877
U248424RT	3439	3321	3365	3455	3478	3528	3625	3635	3743	3817	3932	4045
U278424RT	3612	3596	3647	3750	3774	3829	3939	3952	4071	4154	4284	4412
U308424RT	3786	3875	3929	4044	4068	4130	4253	4267	4402	4491	4634	4776
U338424RT	3991	4082	4141	4265	4292	4359	4490	4504	4648	4748	4899	5052
U368424RT	4195	4290	4356	4486	4515	4586	4725	4742	4894	5001	5164	5330

U128724RT L or R	2588	2711	2746	2811	2826	2863	2931	2943	3020	3073	3157	3242
U158724RT L or R	2652	2778	2814	2882	2901	2937	3013	3020	3103	3158	3246	3332
U188724RT L or R	2820	2920	2958	3032	3050	3090	3168	3182	3269	3329	3422	3517
U218724RT L or R	2994	3105	3147	3228	3248	3292	3380	3393	3489	3555	3658	3761
U248724RT L or R	3236	3232	3276	3364	3384	3430	3527	3537	3641	3710	3822	3931
U248724RT	3477	3361	3404	3498	3519	3569	3671	3680	3790	3864	3981	4096
U278724RT	3684	3642	3691	3797	3822	3878	3990	4002	4124	4208	4340	4469
U308724RT	3890	3923	3980	4095	4121	4185	4309	4323	4460	4551	4698	4841
U338724RT	4104	4135	4196	4321	4349	4415	4549	4566	4711	4811	4965	5121
U368724RT	4317	4345	4412	4546	4574	4647	4788	4807	4961	5070	5235	5401

**Custom Modifications**

ACS	ADDTK	AUTHL	AUTHR	CBO	CCO	CFNTO	CFRMO	CND	DRT	DRWTK	EXBKL	EXBKR	EXL	EXR	FB	FFDL	FFDR	FPEB	FTK	FTKAV	FTKPV	ID	INVFRM	MIP	RD	RECTKL	RECTKR	RT	TD	TKP	VTK	WLI	

\*Not available on 12" and 15" wide

**Construction Upgrades**

APC	ET	PE

**Door Options**

CG.TOP	DPSRR	MFO

**UTILITY with ROLL TRAYS, 84", 87", 90", 93", or 96" TALL, 24" DEEP (cont'd)**

12", 15", 18", 21", or 24"

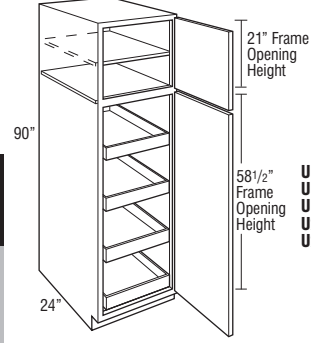

U129024RTAH L or R  
U159024RTAH L or R  
U189024RTAH L or R  
U219024RTAH L or R  
U249024RTAH L or R

24", 27", 30", 33", or 36"

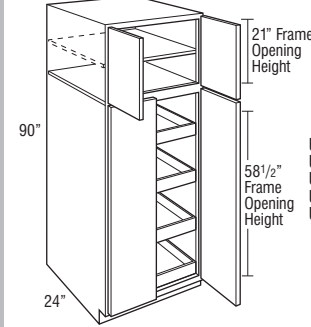

U249024RTAH  
U279024RTAH  
U309024RTAH  
U339024RTAH  
U369024RTAH

Model	1	2	3	4	5	6
<b>U129024RTAH L or R</b>	2041	2107	2319	2472	2581	2660
<b>U159024RTAH L or R</b>	2082	2151	2371	2531	2644	2724
<b>U189024RTAH L or R</b>	2199	2275	2497	2694	2769	2853
<b>U219024RTAH L or R</b>	2313	2396	2641	2859	2940	3030
<b>U249024RTAH L or R</b>	2527	2617	2834	3118	3136	3149
<b>U249024RTAH</b>	2742	2838	3024	3377	3330	3267
<b>U279024RTAH</b>	2838	2949	3159	3553	3500	3536
<b>U309024RTAH</b>	2934	3057	3294	3731	3672	3804
<b>U339024RTAH</b>	3074	3207	3458	3932	3865	4010
<b>U369024RTAH</b>	3214	3358	3625	4131	4063	4212

- AH represents upper section alignment with doors on 24" or 27" high cabinets.
- Four roll trays are included, installed in cabinet.
- Depth can be reduced to a minimum of 12".
- Tall non-mitered doors will have two center panels with cross rail.
- Derazi doors greater than 48" high will be two doors doweled together.

Model	7	8	9	10	11	12	13	14	15	16	17	18
<b>U129024RTAH L or R</b>	2615	2753	2787	2855	2871	2908	2979	2990	3070	3124	3210	3297
<b>U159024RTAH L or R</b>	2679	2821	2859	2926	2949	2984	3061	3070	3154	3210	3300	3390
<b>U189024RTAH L or R</b>	2859	2961	2997	3074	3093	3133	3215	3225	3316	3377	3475	3571
<b>U219024RTAH L or R</b>	3037	3151	3192	3275	3296	3340	3429	3443	3540	3608	3713	3822
<b>U249024RTAH L or R</b>	3274	3275	3319	3405	3428	3477	3573	3584	3688	3760	3875	3984
<b>U249024RTAH</b>	3510	3399	3446	3538	3560	3611	3712	3725	3836	3913	4031	4148
<b>U279024RTAH</b>	3753	3685	3737	3843	3866	3925	4038	4052	4177	4262	4397	4527
<b>U309024RTAH</b>	3996	3970	4030	4147	4174	4238	4364	4377	4517	4611	4758	4905
<b>U339024RTAH</b>	4216	4187	4248	4375	4406	4470	4609	4624	4773	4873	5032	5190
<b>U369024RTAH</b>	4438	4402	4468	4604	4633	4704	4849	4871	5030	5135	5304	5474

**Custom Modifications**

ACS	ADDTK	AUTHL	AUTHR	CBO	CCO	CFNTO	CFRMO	CND	DRT	DRWTK	EXBKL	EXBKR	EXL	EXR	FB	FFDL	FFDR	FPEB	FTK	FTKAV	FTKRV	ID	INVFRM	MIP	RD	RECTKL	RECTKR	RT	TD	TKP	VTK	WLI	

\*Not available on 12" and 15" wide

**Construction Upgrades**

APC	ET	PE

**Door Options**

CG.TOP	DPSRR	MFO

**UTILITY with ROLL TRAYS, 84", 87", 90", 93", or 96" TALL, 24" DEEP (cont'd)**

12", 15", 18", 21", or 24"

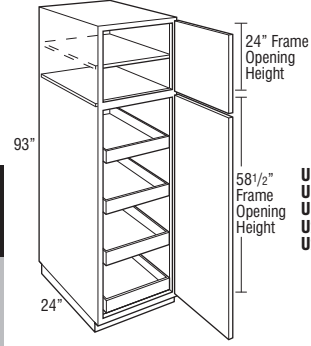

**U129324RTAH L or R**  
**U159324RTAH L or R**  
**U189324RTAH L or R**  
**U219324RTAH L or R**  
**U249324RTAH L or R**

24", 27", 30", 33", or 36"

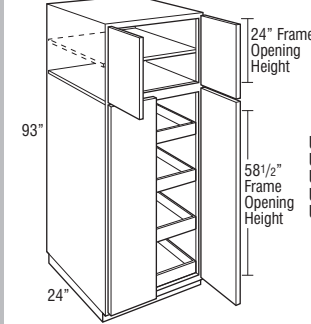

**U249324RTAH**  
**U279324RTAH**  
**U309324RTAH**  
**U339324RTAH**  
**U369324RTAH**

12", 15", 18", 21", or 24"

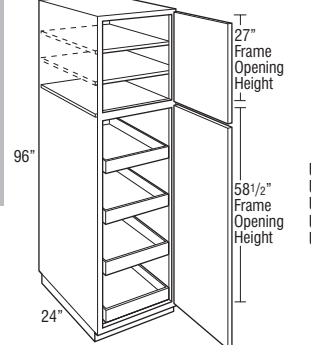

**U129624RT L or R**  
**U159624RT L or R**  
**U189624RT L or R**  
**U219624RT L or R**  
**U249624RT L or R**

24", 27", 30", 33", or 36"

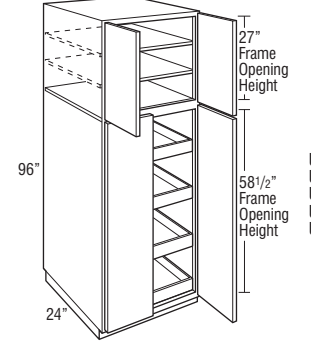

**U249624RT**  
**U279624RT**  
**U309624RT**  
**U339624RT**  
**U369624RT**

Model	1	2	3	4	5	6
<b>U129324RTAH L or R</b>	2109	2178	2407	2524	2659	2733
<b>U159324RTAH L or R</b>	2153	2224	2461	2585	2723	2805
<b>U189324RTAH L or R</b>	2269	2346	2587	2766	2846	2926
<b>U219324RTAH L or R</b>	2391	2473	2741	2936	3022	3113
<b>U249324RTAH L or R</b>	2596	2690	2920	3234	3210	3224
<b>U249324RTAH</b>	2802	2904	3101	3531	3398	3333
<b>U279324RTAH</b>	2906	3022	3242	3726	3577	3614
<b>U309324RTAH</b>	3011	3140	3382	3920	3756	3893
<b>U339324RTAH</b>	3157	3295	3555	4136	3956	4103
<b>U369324RTAH</b>	3302	3449	3731	4350	4156	4312

- AH represents upper section alignment with doors on 24" or 27" high cabinets.
- Separate pedestal base included but packaged separately on 93" tall. Pedestal is designed to create a Recessed Left or Right Toekick application during field installation, or can be centered. Pedestal must be covered with toeboard material.
- Four roll trays are included, installed in cabinet.
- Depth can be reduced to a minimum of 12".
- Tall non-mitered doors will have two center panels with cross rail.
- Derazi doors greater than 48" high will be two doors doweled together.

<b>U129624RT L or R</b>	2109	2178	2407	2524	2659	2733
<b>U159624RT L or R</b>	2153	2224	2461	2585	2723	2805
<b>U189624RT L or R</b>	2269	2346	2587	2766	2846	2926
<b>U219624RT L or R</b>	2391	2473	2741	2936	3022	3113
<b>U249624RT L or R</b>	2596	2690	2920	3234	3210	3224
<b>U249624RT</b>	2802	2904	3101	3531	3398	3333
<b>U279624RT</b>	2906	3022	3242	3726	3577	3614
<b>U309624RT</b>	3011	3140	3382	3920	3756	3893
<b>U339624RT</b>	3157	3295	3555	4136	3956	4103
<b>U369624RT</b>	3302	3449	3731	4350	4156	4312

- Separate pedestal base included but packaged separately on 96" tall. Pedestal is designed to create a Recessed Left or Right Toekick application during field installation, or can be centered. Pedestal must be covered with toeboard material.
- Four roll trays are included, installed in cabinet.
- Depth can be reduced to a minimum of 12".
- Tall non-mitered doors will have two center panels with cross rail.
- Derazi doors greater than 48" high will be two doors doweled together.

Model	7	8	9	10	11	12	13	14	15	16	17	18
<b>U129324RTAH L or R</b>	2670	2835	2870	2945	2960	2997	3073	3080	3166	3225	3316	3404
<b>U159324RTAH L or R</b>	2736	2909	2948	3021	3039	3076	3158	3166	3255	3316	3410	3502
<b>U189324RTAH L or R</b>	2936	3041	3078	3161	3178	3220	3308	3318	3412	3476	3576	3677
<b>U219324RTAH L or R</b>	3124	3240	3281	3370	3390	3438	3532	3544	3647	3714	3828	3938
<b>U249324RTAH L or R</b>	3358	3355	3400	3493	3513	3563	3662	3677	3786	3857	3976	4091
<b>U249324RTAH</b>	3589	3470	3519	3616	3641	3689	3795	3808	3923	4001	4122	4245
<b>U279324RTAH</b>	3898	3767	3823	3932	3957	4014	4133	4147	4274	4363	4500	4637
<b>U309324RTAH</b>	4207	4063	4122	4244	4273	4339	4469	4486	4626	4724	4877	5030
<b>U339324RTAH</b>	4443	4285	4350	4479	4511	4579	4720	4740	4891	4995	5160	5324
<b>U369324RTAH</b>	4676	4504	4575	4714	4749	4820	4971	4991	5154	5264	5441	5616

<b>U129624RT L or R</b>	2670	2835	2870	2945	2960	2997	3073	3080	3166	3225	3316	3404
<b>U159624RT L or R</b>	2736	2909	2948	3021	3039	3076	3158	3166	3255	3316	3410	3502
<b>U189624RT L or R</b>	2936	3041	3078	3161	3178	3220	3308	3318	3412	3476	3576	3677
<b>U219624RT L or R</b>	3124	3240	3281	3370	3390	3438	3532	3544	3647	3714	3828	3938
<b>U249624RT L or R</b>	3358	3355	3400	3493	3513	3563	3662	3677	3786	3857	3976	4091
<b>U249624RT</b>	3589	3470	3519	3616	3641	3689	3795	3808	3923	4001	4122	4245
<b>U279624RT</b>	3898	3767	3823	3932	3957	4014	4133	4147	4274	4363	4500	4637
<b>U309624RT</b>	4207	4063	4122	4244	4273	4339	4469	4486	4626	4724	4877	5030
<b>U339624RT</b>	4443	4285	4350	4479	4511	4579	4720	4740	4891	4995	5160	5324
<b>U369624RT</b>	4676	4504	4575	4714	4749	4820	4971	4991	5154	5264	5441	5616

**Custom Modifications**

ACS	ADDTK	AUTHL AUTHR	CBO	CCO	CFNTO	CFRMO	CND	DRT	DRWTK	EXBKL EXBKR	EXL EXR	FB	FFDL FFDR	FPEB	FTK	FTKAV FTKRV	ID	INVFRM	MIP	RD	RECTKL RECTKR	RT	TD	TKP	VTIK	WLI
			•	•	•	•		•		•	•	•		•					•	•	•*		•			•

\*Not available on 12" wide

**Construction Upgrades**

APC	ET	PE
•	•	•

**Door Options**

CG.TOP	DPSRR	MFO
•	•	•



**UTILITY ORGANIZER CABINET, 84", 87", 90", 93", or 96" TALL, 6" DEEP, 24" WIDE**

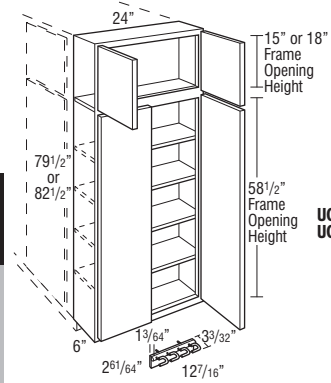

**UOC24846**  
**UOC24876**

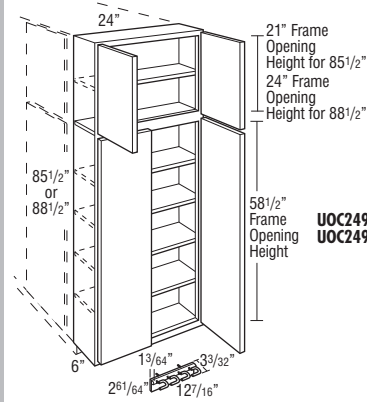

**UOC24906AH**  
**UOC24936AH**

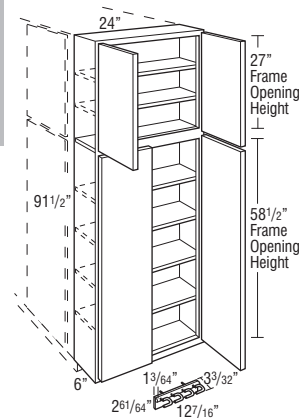

**UOC24966**

Model	1	2	3	4	5	6
<b>UOC24846</b>	1233	1300	1496	1697	2004	1928
<ul style="list-style-type: none"> <li>Includes four adjustable shelves and broom clip packaged separately (not installed).</li> <li>Designed to be installed onto an adjacent 24" deep tall cabinet.</li> <li>For proper installation, adjacent cabinet must have FPEB or 1/4" skin applied.</li> <li>6" overlay fillers can be used on the side to add a decorative touch (Full overlay door styles only).</li> <li>Utility cabinets with depths of 12" or less must be installed to wall studs or onto the end of another tall cabinet.</li> <li>Does not include toeboard or pedestal.</li> <li>Tall non-mitered doors will have two center panels with cross rail.</li> <li>Derazi doors greater than 48" high will be two doors doweled together.</li> </ul>						
<b>UOC24876</b>	1264	1335	1537	1791	2040	1968
<ul style="list-style-type: none"> <li>Includes four adjustable shelves and broom clip packaged separately (not installed).</li> <li>Designed to be installed onto an adjacent 24" deep tall cabinet.</li> <li>For proper installation, adjacent cabinet must have FPEB or 1/4" skin applied.</li> <li>6" overlay fillers can be used on the side to add a decorative touch (Full overlay door styles only).</li> <li>Utility cabinets with depths of 12" or less must be installed to wall studs or onto the end of another tall cabinet.</li> <li>Does not include toeboard or pedestal.</li> <li>Tall non-mitered doors will have two center panels with cross rail.</li> <li>Derazi doors greater than 48" high will be two doors doweled together.</li> </ul>						
<b>UOC24906AH</b>	1293	1370	1574	1882	2077	2006
<ul style="list-style-type: none"> <li>AH represents upper section alignment with doors on 24" or 27" high cabinets.</li> <li>Includes five adjustable shelves and broom clip packaged separately (not installed).</li> <li>Designed to be installed onto an adjacent 24" deep tall cabinet.</li> <li>For proper installation, adjacent cabinet must have FPEB or 1/4" skin applied.</li> <li>6" overlay fillers can be used on the side to add a decorative touch (Full overlay door styles only).</li> <li>Utility cabinets with depths of 12" or less must be installed to wall studs or onto the end of another tall cabinet.</li> <li>Does not include toeboard or pedestal.</li> <li>Tall non-mitered doors will have two center panels with cross rail.</li> <li>Derazi doors greater than 48" high will be two doors doweled together.</li> </ul>						
<b>UOC24936AH</b>	1355	1436	1656	2041	2147	2077
<ul style="list-style-type: none"> <li>AH represents upper section alignment with doors on 24" or 27" high cabinets.</li> <li>Includes five adjustable shelves and broom clip packaged separately (not installed).</li> <li>Designed to be installed onto an adjacent 24" deep tall cabinet.</li> <li>For proper installation, adjacent cabinet must have FPEB or 1/4" skin applied.</li> <li>6" overlay fillers can be used on the side to add a decorative touch (Full overlay door styles only).</li> <li>Utility cabinets with depths of 12" or less must be installed to wall studs or onto the end of another tall cabinet.</li> <li>Does not include toeboard or pedestal.</li> <li>Tall non-mitered doors will have two center panels with cross rail.</li> <li>Derazi doors greater than 48" high will be two doors doweled together.</li> </ul>						
<b>UOC24966</b>	1355	1436	1656	2041	2147	2077
<ul style="list-style-type: none"> <li>Includes six adjustable shelves and broom clip packaged separately (not installed).</li> <li>Designed to be installed onto an adjacent 24" deep tall cabinet.</li> <li>For proper installation, adjacent cabinet must have FPEB or 1/4" skin applied.</li> <li>6" overlay fillers can be used on the side to add a decorative touch (Full overlay door styles only).</li> <li>Utility cabinets with depths of 12" or less must be installed to wall studs or onto the end of another tall cabinet.</li> <li>Does not include toeboard or pedestal.</li> <li>Tall non-mitered doors will have two center panels with cross rail.</li> <li>Derazi doors greater than 48" high will be two doors doweled together.</li> </ul>						

Model	7	8	9	10	11	12	13	14	15	16	17	18
<b>UOC24846</b>	1867	2045	2087	2166	2189	2232	2320	2332	2430	2496	2599	2705
<b>UOC24876</b>	1970	2087	2127	2211	2233	2276	2368	2380	2478	2546	2652	2760
<b>UOC24906AH</b>	2070	2127	2166	2256	2275	2320	2415	2426	2527	2595	2706	2814
<b>UOC24936AH</b>	2246	2201	2244	2334	2353	2401	2496	2509	2613	2684	2795	2910
<b>UOC24966</b>	2246	2201	2244	2334	2353	2401	2496	2509	2613	2684	2795	2910

**Custom Modifications**

ACS	ADDTK	AUTHL	AUTHR	CBO	CCO	CFNTO	CFRMO	CND	DRT	DRWTK	EXBKL	EXBKR	EXL	EXR	FB	FFDL	FFDR	FPEB	FTK	FTKAV	FTKRV	ID	INVRM	MIP	RD	RECTKL	RECTKR	RT	TD	TKP	VTK	WLI
				•	•	•	•											STD					•	•								•

**Construction Upgrades**

APC	ET	PE
•		

**Door Options**

CG.TOP	DPSRR	MFO
•	•	•

**UTILITY ORGANIZER DROP ZONE CABINET, 84", 87", 90", 93", or 96" HIGH, 9" DEEP, 24" WIDE**

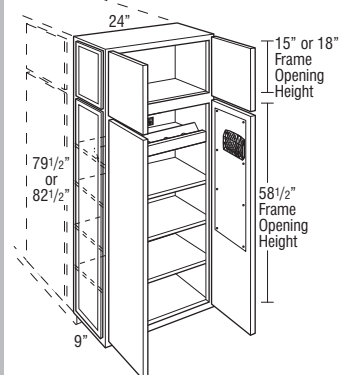
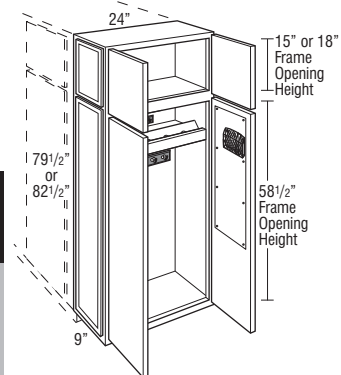

UOCDZ24849AEL  
UOCDZ24849AER

UOCDZ24879AEL  
UOCDZ24879AER

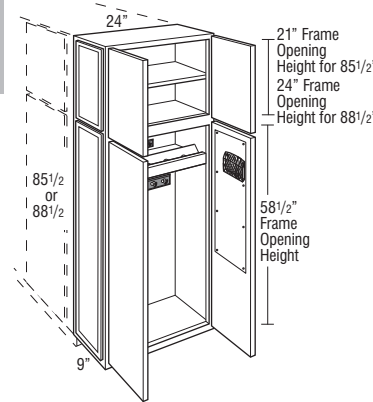

UOCDZ24909AEL  
UOCDZ24909AER

UOCDZ24939AEL  
UOCDZ24939AER

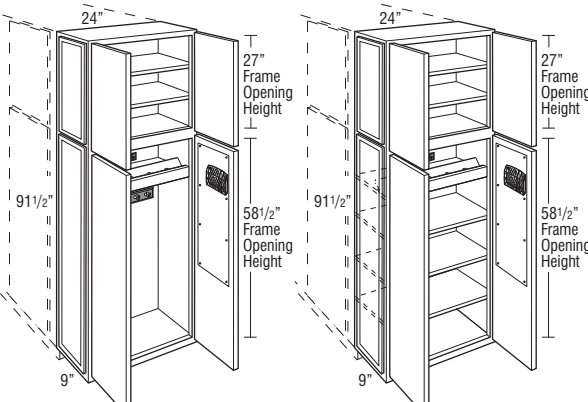
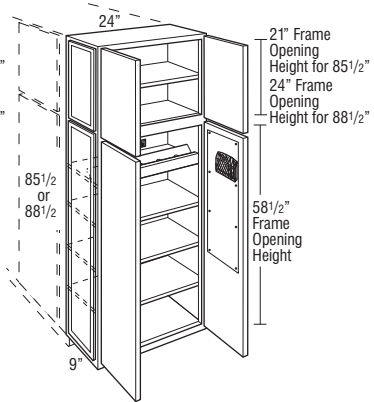

UOCDZ24969AEL  
UOCDZ24969AER

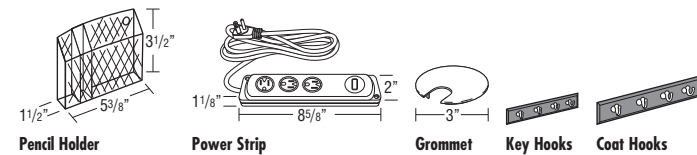

Model	1	2	3	4	5	6
UOCDZ24849AEL	2225	2292	2488	2689	2996	2920
UOCDZ24849AER	2225	2292	2488	2689	2996	2920
UOCDZ24879AEL	2256	2327	2529	2783	3032	2960
UOCDZ24879AER	2256	2327	2529	2783	3032	2960
UOCDZ24909AEL	2285	2362	2566	2874	3069	2998
UOCDZ24909AER	2285	2362	2566	2874	3069	2998
UOCDZ24939AEL	2347	2428	2648	3033	3139	3069
UOCDZ24939AER	2347	2428	2648	3033	3139	3069
UOCDZ24969AEL	2347	2428	2648	3033	3139	3069
UOCDZ24969AER	2347	2428	2648	3033	3139	3069

- AH represents upper section alignment with doors on 24" or 27" high cabinets.
- Features magnetic whiteboards on back of lower doors, one magnetic black mesh pencil holder, charging station with power strip, black plastic grommet for power cord, key hooks, and coat hooks. Accessories are field installed.
- Charging station functions as an adjustable shelf, features five cord cut-out areas and includes a UL listed power strip with three standard 110-volt plug-ins and one USB charging port.
- One adjustable shelf in upper section on 90" and 93", two adjustable shelves for 96", and three adjustable shelves in lower section.
- Authentic Ends are standard on one side. Specify AEL model for installation on the right side of a tall cabinet. Specify AER model for installation on the left side of a tall cabinet. Opposite end panel will feature FPEB construction (if decorative doors are desired on both sides of cabinet, order No Hinge Route doors for a Tall Pantry Pull-out).
- Designed to be installed onto an adjacent 24" deep tall cabinet.
- For proper installation, adjacent cabinet must have FPEB or 1/4" skin applied.
- Utility cabinets with depths of 12" or less must be installed to wall studs or onto the end of another tall cabinet.
- Does not include toeboard or pedestal.
- Tall non-mitered doors will have two center panels with cross rail.
- Derazi doors greater than 48" high will be two doors doweled together.

Model	7	8	9	10	11	12	13	14	15	16	17	18
UOCDZ24849AEL	2859	3037	3079	3158	3181	3224	3312	3324	3422	3488	3591	3697
UOCDZ24849AER	2859	3037	3079	3158	3181	3224	3312	3324	3422	3488	3591	3697
UOCDZ24879AEL	2962	3079	3119	3203	3225	3268	3360	3372	3470	3538	3644	3752
UOCDZ24879AER	2962	3079	3119	3203	3225	3268	3360	3372	3470	3538	3644	3752
UOCDZ24909AEL	3062	3119	3158	3248	3267	3312	3407	3418	3519	3587	3698	3806
UOCDZ24909AER	3062	3119	3158	3248	3267	3312	3407	3418	3519	3587	3698	3806
UOCDZ24939AEL	3238	3193	3236	3326	3345	3393	3488	3501	3605	3676	3787	3902
UOCDZ24939AER	3238	3193	3236	3326	3345	3393	3488	3501	3605	3676	3787	3902
UOCDZ24969AEL	3238	3193	3236	3326	3345	3393	3488	3501	3605	3676	3787	3902
UOCDZ24969AER	3238	3193	3236	3326	3345	3393	3488	3501	3605	3676	3787	3902

**Custom Modifications**

ACS	ADDTK	AUTHL	AUTHR	CBO	CCO	CFNTO	CFRMO	CND	DRT	DRWTK	EXBKL	EXBKR	EKL	EXR	FB	FFDL	FFDR	FPEB	FTK	FTKAV	FTKRV	ID	INVFRM	MIP	RD	RECTKL	RECTKR	RT	TD	TKP	VTK	WLI	

**Construction Upgrades**

APC	ET	PE

**Door Options**

CG.TOP	DPSRR	MFO

**PANTRY TOP UNIT with SHELVES,  
SINGLE DOOR, 24" DEEP**

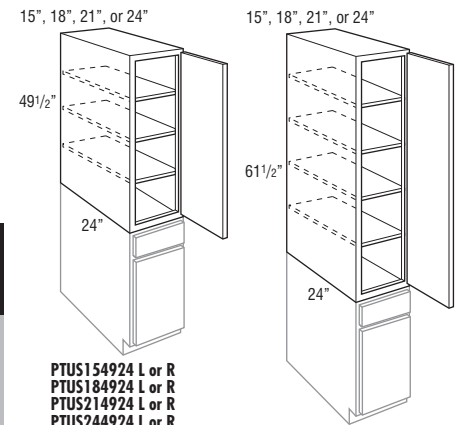

PTUS154924 L or R  
PTUS184924 L or R  
PTUS214924 L or R  
PTUS244924 L or R

PTUS156124 L or R  
PTUS186124 L or R  
PTUS216124 L or R  
PTUS246124 L or R

Model	1	2	3	4	5	6
PTUS154924 L or R	849	963	1275	1275	1275	1275
PTUS184924 L or R	949	1084	1334	1334	1334	1334
PTUS214924 L or R	1057	1189	1453	1453	1453	1453
PTUS244924 L or R	1112	1240	1512	1512	1512	1512
PTUS156124 L or R	953	1077	1417	1417	1417	1417
PTUS186124 L or R	1064	1187	1521	1521	1521	1543
PTUS216124 L or R	1175	1296	1625	1625	1625	1667
PTUS246124 L or R	1232	1350	1677	1677	1677	1731

- Three adjustable shelves included with 49 1/2" high, and four adjustable shelves included with 61 1/2" high.
- Sets on any 15", 18", 21", or 24" wide base (B15 shown). No countertop is needed.
- Can be reduced in depth to 6".
- Because of exposed seam when stacking, FPEB is not recommended.
- Be sure to use an end panel skin to connect the seam on the side of the stacked cabinets.
- Tall non-mitered doors will have two center panels with cross rail.
- Derazi doors will be two doors doweled together.

**PANTRY TOP UNIT with SHELVES,  
DOUBLE DOOR, 24" DEEP**

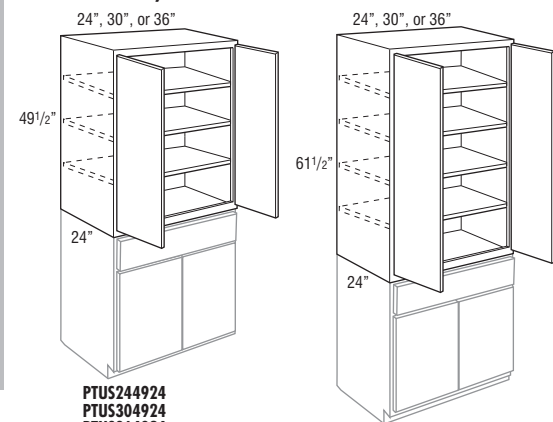

PTUS244924  
PTUS304924  
PTUS364924

PTUS246124  
PTUS306124  
PTUS366124

PTUS244924	1166	1291	1572	1572	1572	1572
PTUS304924	1383	1497	1808	1808	1808	1808
PTUS364924	1548	1683	1932	1932	1932	1932
PTUS246124	1287	1405	1728	1728	1728	1793
PTUS306124	1509	1624	1935	1935	1935	2043
PTUS366124	1662	1798	2049	2049	2049	2155

- Three adjustable shelves included with 49 1/2" high, and four adjustable shelves included with 61 1/2" high.
- Sets on any 24", 30", or 36" wide base (B30 shown). No countertop is needed.
- Can be reduced in depth to 6".
- Because of exposed seam when stacking, FPEB is not recommended.
- Be sure to use an end panel skin to connect the seam on the side of the stacked cabinets.
- Tall non-mitered doors will have two center panels with cross rail.
- Derazi doors will be two doors doweled together.

Model	7	8	9	10	11	12	13	14	15	16	17	18
PTUS154924 L or R	1511	1402	1449	1539	1559	1607	1705	1716	1824	1895	2010	2767
PTUS184924 L or R	1582	1463	1513	1610	1633	1683	1786	1799	1912	1986	2109	3151
PTUS214924 L or R	1698	1582	1631	1725	1748	1797	1899	1913	2023	2096	2217	3189
PTUS244924 L or R	1756	1641	1690	1784	1805	1855	1955	1969	2079	2152	2271	3208
PTUS156124 L or R	1675	1554	1606	1704	1727	1779	1886	1899	2015	2093	2218	3044
PTUS186124 L or R	1775	1680	1732	1831	1852	1905	2013	2026	2142	2221	2345	3120
PTUS216124 L or R	1874	1805	1857	1957	1979	2032	2139	2152	2269	2347	2473	3198
PTUS246124 L or R	1924	1870	1920	2021	2042	2094	2204	2216	2333	2412	2538	3237

**Custom Modifications**

ACS	ADDTK	AUTHL AUTHR	CBO	CCO	CFNTO	CFRMO	CND	DRT	DRWTK	EXBKL EXBKR	EKL EXR	FB	FFDL FFDR	FPEB	FTK	FTKAV FTKFV	ID	INVERM	MIP	RD	RECTKL RECTKR	RT	TD	TKP	VTK	WLI
•	•	•*	•	•	•	•	•	•	•	•	•	•	•	•	•	•	•	•	•	•*	•	•	•	•	•	•

\*RD12 is not compatible with AUTHL or AUTHR

**Construction Upgrades**

APC	ET	PE
•	•	•

**Door Options**

CG.TOP	DPSRR	MFO
•	•	•

PTUS244924	1815	1700	1747	1841	1864	1912	2012	2026	2134	2208	2326	3227
PTUS304924	2046	1935	1981	2072	2092	2139	2237	2252	2356	2429	2542	3301
PTUS364924	2181	2063	2114	2209	2233	2283	2384	2396	2511	2585	2705	3750

PTUS246124	1974	1932	1983	2084	2104	2158	2266	2280	2396	2475	2602	3274
PTUS306124	2173	2183	2234	2337	2358	2411	2519	2533	2652	2729	2857	3428
PTUS366124	2297	2303	2353	2461	2484	2540	2654	2667	2790	2874	3006	3866

**Custom Modifications**

ACS	ADDTK	AUTHL AUTHR	CBO	CCO	CFNTO	CFRMO	CND	DRT	DRWTK	EXBKL EXBKR	EKL EXR	FB	FFDL FFDR	FPEB	FTK	FTKAV FTKFV	ID	INVERM	MIP	RD	RECTKL RECTKR	RT	TD	TKP	VTK	WLI
•	•	•*	•	•	•	•	•	•	•	•	•	•	•	•	•	•	•	•	•	•*	•	•	•	•	•	•

\*RD12 is not compatible with AUTHL or AUTHR

**Construction Upgrades**

APC	ET	PE
•	•	•

**Door Options**

CG.TOP	DPSRR	MFO
•	•	•

**PANTRY TOP UNIT, SINGLE DOOR, 24" DEEP**

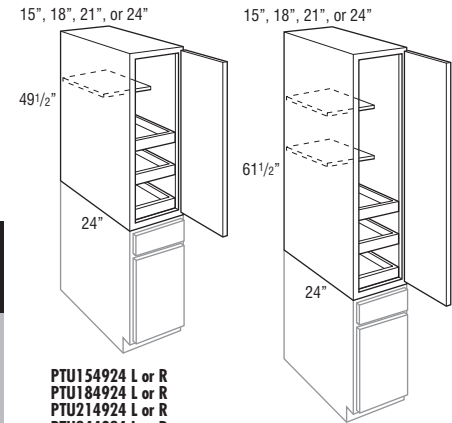

PTU154924 L or R  
PTU184924 L or R  
PTU214924 L or R  
PTU244924 L or R

PTU156124 L or R  
PTU186124 L or R  
PTU216124 L or R  
PTU246124 L or R

Model	1	2	3	4	5	6
PTU154924 L or R	1150	1264	1576	1576	1576	1576
PTU184924 L or R	1250	1385	1635	1635	1635	1635
PTU214924 L or R	1358	1490	1754	1754	1754	1754
PTU244924 L or R	1413	1541	1813	1813	1813	1813
PTU156124 L or R	1254	1378	1718	1718	1718	1718
PTU186124 L or R	1365	1488	1822	1822	1822	1844
PTU216124 L or R	1476	1597	1926	1926	1926	1968
PTU246124 L or R	1533	1651	1978	1978	1978	2032

- One 15" deep adjustable shelf included with 49 1/2" high, and two 15" deep adjustable shelves included with 61 1/2" high.
- Three roll trays are included, installed in cabinet.
- Sets on any 15", 18", 21", or 24" wide base (B15 shown). No countertop is needed.
- Can be reduced in depth to 12".
- Because of exposed seam when stacking, FPEB is not recommended.
- Be sure to use an end panel skin to connect the seam on side of stacked cabinets.
- Tall non-mitered doors will have two center panels with cross rail.
- Derazi doors will be two doors doweled together.

**PANTRY TOP UNIT, DOUBLE DOOR, 24" DEEP**

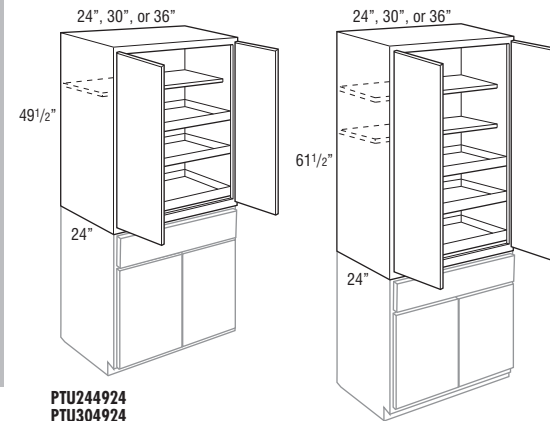

PTU244924  
PTU304924  
PTU364924

PTU246124  
PTU306124  
PTU366124

PTU244924	1467	1592	1873	1873	1873	1873
PTU304924	1684	1798	2109	2109	2109	2109
PTU364924	1849	1984	2233	2233	2233	2233
PTU246124	1588	1706	2029	2029	2029	2094
PTU306124	1810	1925	2236	2236	2236	2344
PTU366124	1963	2099	2350	2350	2350	2456

- One 15" deep adjustable shelf included with 49 1/2" high, and two 15" deep adjustable shelves included with 61 1/2" high.
- Three roll trays are included, installed in cabinet.
- Sets on any 24", 30", or 36" wide base. (B30 shown.) No countertop is needed.
- Can be reduced in depth to 12".
- Because of exposed seam when stacking, FPEB is not recommended.
- Be sure to use an end panel skin to connect the seam on side of stacked cabinets.
- Tall non-mitered doors will have two center panels with cross rail.
- Derazi doors will be two doors doweled together.

Model	7	8	9	10	11	12	13	14	15	16	17	18
PTU154924 L or R	1812	1703	1750	1840	1860	1908	2006	2017	2125	2196	2311	3068
PTU184924 L or R	1883	1764	1814	1911	1934	1984	2087	2100	2213	2287	2410	3452
PTU214924 L or R	1999	1883	1932	2026	2049	2098	2200	2214	2324	2397	2518	3490
PTU244924 L or R	2057	1942	1991	2085	2106	2156	2256	2270	2380	2453	2572	3509
PTU156124 L or R	1976	1855	1907	2005	2028	2080	2187	2200	2316	2394	2519	3345
PTU186124 L or R	2076	1981	2033	2132	2153	2206	2314	2327	2443	2522	2646	3421
PTU216124 L or R	2175	2106	2158	2258	2280	2333	2440	2453	2570	2648	2774	3499
PTU246124 L or R	2225	2171	2221	2322	2343	2395	2505	2517	2634	2713	2839	3538

**Custom Modifications**

ACS	ADDTK	AUTHL AUTHR	CBO	CCO	CFNT0	CFRMO	CND	DRT	DRWTK	EXBKL EXBKR	EXL EXR	FB	FD	FFDL FFDR	FPEB	FTK	FTKAV FTKRV	ID	INVFRM	MIP	RD	RECTKL RECTKR	RT	TD	TKP	VTK	WLI
	•	•*	•	•	•	•		•		•	•	•			•					•	•*						•

\*RD12 is not compatible with AUTHL or AUTHR

**Construction Upgrades**

APC	ET	PE
•		•

**Door Options**

CG.TOP	DPSRR	MFO
	•	•

PTU244924	2116	2001	2048	2142	2165	2213	2313	2327	2435	2509	2627	3528
PTU304924	2347	2236	2282	2373	2393	2440	2538	2553	2657	2730	2843	3602
PTU364924	2482	2364	2415	2510	2534	2584	2685	2697	2812	2886	3006	4051

PTU246124	2275	2233	2284	2385	2405	2459	2567	2581	2697	2776	2903	3575
PTU306124	2474	2484	2535	2638	2659	2712	2820	2834	2953	3030	3158	3729
PTU366124	2598	2604	2654	2762	2785	2841	2955	2968	3091	3175	3307	4167

**Custom Modifications**

ACS	ADDTK	AUTHL AUTHR	CBO	CCO	CFNT0	CFRMO	CND	DRT	DRWTK	EXBKL EXBKR	EXL EXR	FB	FD	FFDL FFDR	FPEB	FTK	FTKAV FTKRV	ID	INVFRM	MIP	RD	RECTKL RECTKR	RT	TD	TKP	VTK	WLI
	•	•*	•	•	•	•		•		•	•	•			•					•	•*						•

\*RD12 is not compatible with AUTHL or AUTHR

**Construction Upgrades**

APC	ET	PE
•		•

**Door Options**

CG.TOP	DPSRR	MFO
	•	•

**PANTRY TOP UNIT with PULL-OUT, 49 1/2" TALL, 24" DEEP**

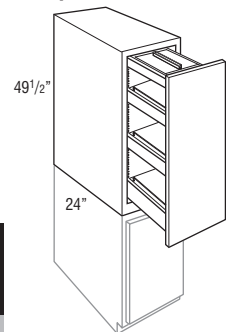

Model	1	2	3	4	5	6
PTUP154924	1604	1718	2031	2031	2031	2031
PTUP184924	1704	1840	2089	2089	2089	2089

- Two adjustable and one fixed bottom shelf with metallic finish wire rail sides. Natural finish pull-out shelves are 20 11/16" deep.
- Sets on any 15" or 18" wide base. No countertop is needed.
- Because of exposed seam when stacking, FPEB is not recommended.
- Be sure to use an end panel skin to connect the seam on side of stacked cabinets.
- Tall non-mitered doors will have two center panels with cross rail.
- Derazi doors greater than 48" high will be two doors doweled together.
- For full access from both sides of unit, do not install against a wall or next to deeper appliances and cabinets.

Model	7	8	9	10	11	12	13	14	15	16	17	18
PTUP154924	2267	2157	2204	2294	2315	2362	2461	2472	2579	2651	2765	3522
PTUP184924	2337	2219	2269	2366	2388	2438	2541	2555	2667	2740	2863	3906

**Custom Modifications**

ACS	ADDTK	AUTHL AUTHR	CBO	CCO	CFNTD	CFRMO	CND	DRT	DRWTK	EXBKL EXBKR	EXL EXR	FB	FFDL FFDR	FPEB	FTK	FTKAV FTKRV	ID	INVRM	MIP	RD	RECTKL RECTKR	RT	TD	TKP	VTK	WLI
	•	•	•	•		•				•	•	•		•					•		•					•

**Construction Upgrades**

APC	ET	PE
•		•

**Door Options**

CG.TOP	DPSRR	MFO
	•	•

TPP98424 L or R	2592	2698	2731	2796	2811	2846	2914	2926	2999	3051	3134	3217
TPP128424 L or R	2737	2843	2876	2941	2956	2991	3059	3071	3144	3196	3279	3362
TPP158424 L or R	2874	2985	3020	3089	3104	3143	3213	3220	3301	3356	3442	3526
TPP188424 L or R	3034	3128	3167	3241	3258	3296	3374	3385	3471	3530	3622	3713

TPP98724 L or R	2618	2741	2776	2841	2856	2893	2961	2973	3050	3103	3187	3272
TPP128724 L or R	2763	2886	2921	2986	3001	3038	3106	3118	3195	3248	3332	3417
TPP158724 L or R	2903	3029	3065	3133	3152	3188	3264	3271	3354	3409	3497	3583
TPP188724 L or R	3071	3171	3209	3283	3301	3341	3419	3433	3520	3580	3673	3768

TPP99024AH L or R	2645	2783	2817	2885	2901	2938	3009	3020	3100	3154	3240	3327
TPP129024AH L or R	2790	2928	2962	3030	3046	3083	3154	3165	3245	3299	3385	3472
TPP159024AH L or R	2930	3072	3110	3177	3200	3235	3312	3321	3405	3461	3551	3641
TPP189024AH L or R	3110	3212	3248	3325	3344	3384	3466	3476	3567	3628	3726	3822

**Custom Modifications**

ACS	ADDTK	AUTHL AUTHR	CBO	CCO	CFNTD	CFRMO	CND	DRT	DRWTK	EXBKL EXBKR	EXL EXR	FB	FFDL FFDR	FPEB	FTK	FTKAV FTKRV	ID	INVRM	MIP	RD	RECTKL RECTKR	RT	TD	TKP	VTK	WLI
		•	•	•		•			•	•	•	•		•	•	•			•		•	•	•	•	•	•

\*Available only on 18" wide \*Not available on 9" and 12" wide

**Construction Upgrades**

APC	ET	PE
•		•

**Door Options**

CG.TOP	DPSRR	MFO
	•	•

TPP99324AH L or R	2700	2865	2900	2975	2990	3027	3103	3110	3196	3255	3346	3434
TPP129324AH L or R	2845	3010	3045	3120	3135	3172	3248	3255	3341	3400	3491	3579
TPP159324AH L or R	2987	3160	3199	3272	3290	3327	3409	3417	3506	3567	3661	3753
TPP189324AH L or R	3187	3292	3329	3412	3429	3471	3559	3569	3663	3727	3827	3928

TPP99624 L or R	2700	2865	2900	2975	2990	3027	3103	3110	3196	3255	3346	3434
TPP129624 L or R	2845	3010	3045	3120	3135	3172	3248	3255	3341	3400	3491	3579
TPP159624 L or R	2987	3160	3199	3272	3290	3327	3409	3417	3506	3567	3661	3753
TPP189624 L or R	3187	3292	3329	3412	3429	3471	3559	3569	3663	3727	3827	3928

**Custom Modifications**

ACS	ADDTK	AUTHL AUTHR	CBO	CCO	CFNTD	CFRMO	CND	DRT	DRWTK	EXBKL EXBKR	EXL EXR	FB	FFDL FFDR	FPEB	FTK	FTKAV FTKRV	ID	INVRM	MIP	RD	RECTKL RECTKR	RT	TD	TKP	VTK	WLI
		•	•	•		•				•	•	•		•					•		•	•	•	•	•	•

**Construction Upgrades**

APC	ET	PE
•		•

**Door Options**

CG.TOP	DPSRR	MFO
	•	•

**TALL PANTRY PULL-OUT, 84", 87", or 90" TALL, 24" DEEP**

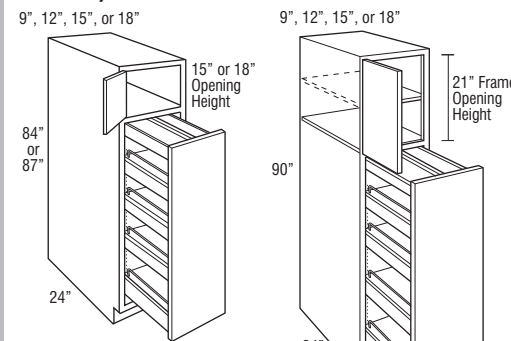

TPP98424 L or R  
TPP128424 L or R  
TPP158424 L or R  
TPP188424 L or R

TPP98724 L or R  
TPP128724 L or R  
TPP158724 L or R  
TPP188724 L or R

TPP99024AH L or R  
TPP129024AH L or R  
TPP159024AH L or R  
TPP189024AH L or R

TPP98424 L or R	2007	2064	2264	2457	2539	2608
TPP128424 L or R	2152	2209	2409	2602	2684	2753
TPP158424 L or R	2266	2327	2534	2735	2820	2893
TPP188424 L or R	2379	2449	2657	2877	2944	3026

TPP98724 L or R	2038	2102	2308	2480	2575	2648
TPP128724 L or R	2183	2247	2453	2625	2720	2793
TPP158724 L or R	2299	2364	2579	2759	2859	2935
TPP188724 L or R	2414	2487	2704	2913	2982	3065

TPP99024AH L or R	2071	2137	2349	2502	2611	2690
TPP129024AH L or R	2216	2282	2494	2647	2756	2835
TPP159024AH L or R	2333	2402	2622	2782	2895	2975
TPP189024AH L or R	2450	2526	2748	2945	3020	3104

- AH represents upper section alignment with doors on 24" or 27" high cabinets.
- Three adjustable shelves and one fixed bottom shelf with metallic finish wire rail sides. Natural finish wood pull-out shelves are 20 11/16" deep. Pull-out features top/bottom mounted soft-close full extension guides.
- 84" and 87" high do not include shelves in upper section. Upper section 15" or 18".
- Tall non-mitered doors will have two center panels with cross rail.
- Derazi doors greater than 48" high will be two doors doweled together.
- For full access from both sides of unit, do not install against a wall or next to deeper appliances and cabinets.
- Pull-out mechanism not available for order for field installation, only available factory installed.

**TALL PANTRY PULL-OUT, 93" or 96" TALL, 24" DEEP**

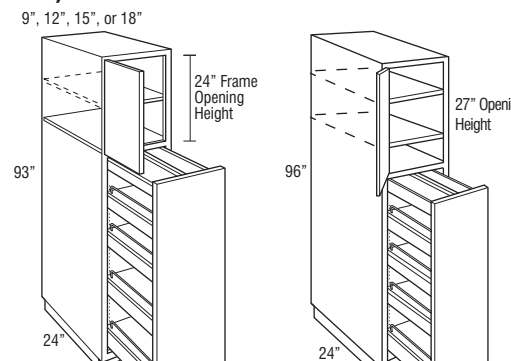

TPP99324AH L or R  
TPP129324AH L or R  
TPP159324AH L or R  
TPP189324AH L or R

TPP99624 L or R  
TPP129624 L or R  
TPP159624 L or R  
TPP189624 L or R

TPP99324AH L or R	2139	2208	2437	2554	2689	2763
TPP129324AH L or R	2284	2353	2582	2699	2834	2908
TPP159324AH L or R	2404	2475	2712	2836	2974	3056
TPP189324AH L or R	2520	2597	2838	3017	3097	3177

TPP99624 L or R	2139	2208	2437	2554	2689	2763
TPP129624 L or R	2284	2353	2582	2699	2834	2908
TPP159624 L or R	2404	2475	2712	2836	2974	3056
TPP189624 L or R	2520	2597	2838	3017	3097	3177

- AH represents upper section alignment with doors on 24" or 27" high cabinets.
- Three adjustable shelves and one fixed bottom shelf with metallic finish wire rail sides. Natural finish wood pull-out shelves are 20 11/16" deep. Pull-out features top/bottom mounted soft-close full extension guides.
- Separate pedestal base included but packaged separately on 93" and 96" tall. Pedestal is designed to create a Recessed Left or Right Toe Kick application during field installation, or can be centered. Pedestal must be covered with toeboard material.
- Tall non-mitered doors will have two center panels with cross rail.
- Derazi doors greater than 48" high will be two doors doweled together.
- For full access from both sides of unit, do not install against a wall or next to deeper appliances and cabinets.
- Pull-out mechanism not available for order for field installation, only available factory installed.

**UTILITY STORAGE with PANTRY  
PULL-OUT, 84", 87", 90", 93", or  
96" TALL, 24" DEEP**

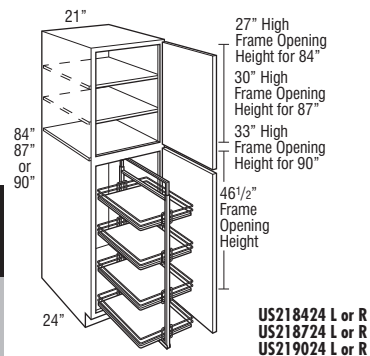

**US218424 L or R  
US218724 L or R  
US219024 L or R**

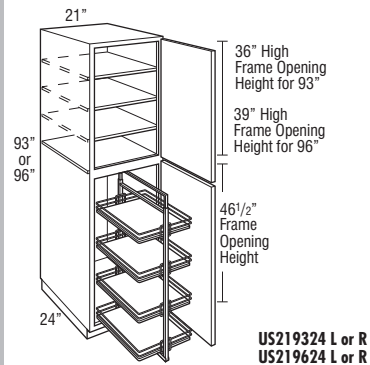

**US219324 L or R  
US219624 L or R**

Model	1	2	3	4	5	6
<b>US218424 L or R</b>	2315	2393	2620	2864	2939	3029
<b>US218724 L or R</b>	2354	2434	2670	2901	2981	3070
<b>US219024 L or R</b>	2394	2477	2722	2940	3021	3111
<b>US219324 L or R</b>	2472	2554	2822	3017	3103	3194
<b>US219624 L or R</b>	2472	2554	2822	3017	3103	3194

- If Decorative Door End panels are desired see DADOORB and DADOORW.
- Full extension pantry pull-out with four plywood shelves and metal rails. Each shelf is 17" wide, 20 7/16" deep, and 4" high.
- Separate pedestal base included but packaged separately on 93" and 96" tall. Pedestal is designed to create a Recessed Left or Right Toekick application during field installation, or can be centered. Pedestal must be covered with toeboard material.
- Tall non-mitered doors will have two center panels with cross rail.
- Derazi doors greater than 48" high will be two doors doweled together.

Model	7	8	9	10	11	12	13	14	15	16	17	18
<b>US218424 L or R</b>	3035	3142	3182	3264	3281	3325	3410	3422	3519	3582	3683	3785
<b>US218724 L or R</b>	3075	3186	3228	3309	3329	3373	3461	3474	3570	3636	3739	3842
<b>US219024 L or R</b>	3118	3232	3273	3356	3377	3421	3510	3524	3621	3689	3794	3903
<b>US219324 L or R</b>	3205	3321	3362	3451	3471	3519	3613	3625	3728	3795	3909	4019
<b>US219624 L or R</b>	3205	3321	3362	3451	3471	3519	3613	3625	3728	3795	3909	4019

**Custom Modifications**

ACS	ADDTK	AUTHL	AUTHR	CBO	CCO	CFNT0	CFRMO	CND	DRT	DRWTK	EXBKL	EXBKR	EXL	EXR	FB	FFDL	FFDR	FPEB	FTK	FTKAV	FTKRV	ID	INVFRM	MIP	RD	RECTKL	RECTKR	RT	TD	TKP	VTK	WLI
				•	•	•	•			•*	•	•	•	•		•	•	•*	•*					•		•			•*	•*	•	

\*Not available on 93" and 96" tall

**Construction Upgrades**

APC	ET	PE
•		

**Door Options**

CG.TOP	DPSRR	MFO
•	•	•

<b>US218424PP L or R</b>	3344	3451	3491	3573	3590	3634	3719	3731	3828	3891	3992	4094
<b>US218724PP L or R</b>	3384	3495	3537	3618	3638	3682	3770	3783	3879	3945	4048	4151
<b>US219024PP L or R</b>	3427	3541	3582	3665	3686	3730	3819	3833	3930	3998	4103	4212
<b>US219324PP L or R</b>	3616	3732	3773	3862	3882	3930	4024	4036	4139	4206	4320	4430
<b>US219624PP L or R</b>	3616	3732	3773	3862	3882	3930	4024	4036	4139	4206	4320	4430

**Custom Modifications**

ACS	ADDTK	AUTHL	AUTHR	CBO	CCO	CFNT0	CFRMO	CND	DRT	DRWTK	EXBKL	EXBKR	EXL	EXR	FB	FFDL	FFDR	FPEB	FTK	FTKAV	FTKRV	ID	INVFRM	MIP	RD	RECTKL	RECTKR	RT	TD	TKP	VTK	WLI
				•	•	•	•			•*	•	•	•	•		•	•	•*	•*					•		•			•*	•*	•	

\*Not available on 93" and 96" tall

**Construction Upgrades**

APC	ET	PE
•		

**Door Options**

CG.TOP	DPSRR	MFO
	•	•

**UTILITY STORAGE with PANTRY  
PULL-OUT and POT and PAN RACK,  
84", 87", 90", 93", or 96" TALL,  
24" DEEP**

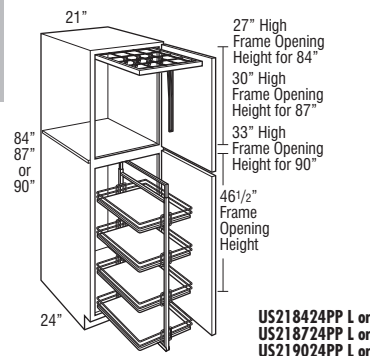

**US218424PP L or R  
US218724PP L or R  
US219024PP L or R**

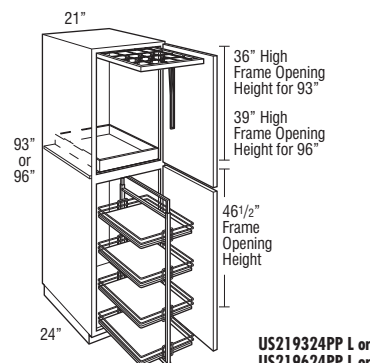

**US219324PP L or R  
US219624PP L or R**

<b>US218424PP L or R</b>	2624	2702	2929	3173	3248	3338
<b>US218724PP L or R</b>	2663	2743	2979	3210	3290	3379
<b>US219024PP L or R</b>	2703	2786	3031	3249	3330	3420
<b>US219324PP L or R</b>	2883	2965	3233	3428	3514	3605
<b>US219624PP L or R</b>	2883	2965	3233	3428	3514	3605

- Full extension Pot and Pan Rack features six chrome hooks and is mounted to the top of the cabinet. Maximum Weight Capacity: 47 lbs.
- Full extension pantry pull-out with four plywood shelves and metal rails. Each shelf is 17" wide, 20 7/16" deep, and 4" high.
- Separate pedestal base included but packaged separately on 93" and 96" tall. Pedestal is designed to create a Recessed Left or Right Toekick application during field installation, or can be centered. Pedestal must be covered with toeboard material.
- Tall non-mitered doors will have two center panels with cross rail.
- Derazi doors greater than 48" high will be two doors doweled together.

**PANTRY UNIT, 84", 87", 90", 93", or 96" TALL, 24" DEEP**

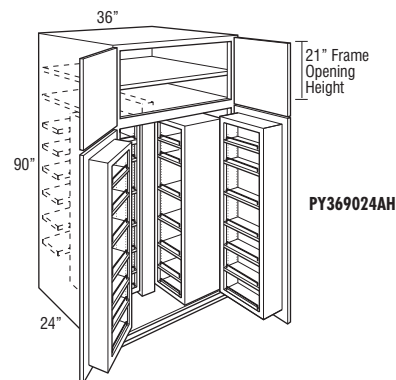
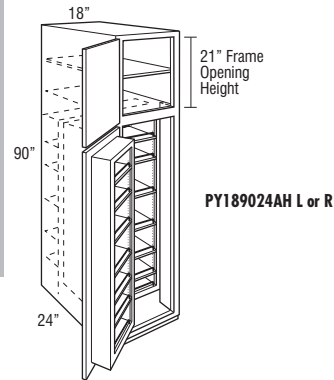
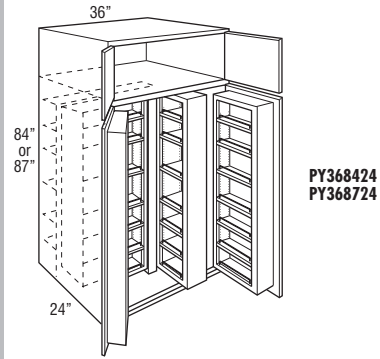
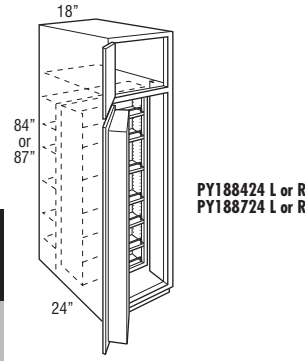

Model	1	2	3	4	5	6
<b>PY188424 L or R</b>	1924	2045	2265	2423	2484	2593
<b>PY368424</b>	3275	3483	4021	4314	4422	4621
<b>PY188724 L or R</b>	1961	2085	2313	2483	2518	2625
<b>PY368724</b>	3310	3520	4068	4377	4433	4631

- Shelves on swing-out units, mounting rails, and door racks have a furniture board core with natural finish wood fronts and metallic finish wire rails. Door mounted rack includes 6 adjustable shelves and one fixed shelf. Swing-outs include 4 adjustable shelves and 3 fixed shelves. Swing-out and door racks included but shipped separately for field installation, includes mounting screws and installation instructions. Adjustable shelves for use in back of cabinet are 4 1/2" deep, six included.
- For PY18, use TF384 when installed against wall (or next to a full depth refrigerator.)
- Tall non-mitered doors will have two center panels with cross rail.
- Derazi doors greater than 48" high will be two doors doweled together.

- Shelves on swing-out units, mounting rails, and door racks have a furniture board core with natural finish wood fronts and metallic finish wire rails. Door mounted rack includes 6 adjustable shelves and one fixed shelf. Swing-outs include 4 adjustable shelves and 3 fixed shelves. Swing-out and door racks included but shipped separately for field installation, includes mounting screws and installation instructions. Adjustable shelves for use in back of cabinet are 4 1/2" deep, six included.
- For PY18, use TF387 when installed against wall (or next to a full depth refrigerator.)
- Tall non-mitered doors will have two center panels with cross rail.
- Derazi doors greater than 48" high will be two doors doweled together.

<b>PY189024AH L or R</b>	2001	2123	2359	2542	2549	2659
<b>PY369024AH</b>	3348	3558	4116	4439	4442	4642

- AH represents upper section alignment with doors on 24" or 27" high cabinets.
- Shelves on swing-out units, mounting rails, and door racks have a furniture board core with natural finish wood fronts and metallic finish wire rails. Door mounted rack includes 6 adjustable shelves and one fixed shelf. Swing-outs include 4 adjustable shelves and 3 fixed shelves. Swing-out and door racks included but shipped separately for field installation, includes mounting screws and installation instructions. Adjustable shelves for use in back of cabinet are 4 1/2" deep, six included.
- For PY18, use TF390 when installed against wall (or next to a full depth refrigerator.)
- Tall non-mitered doors will have two center panels with cross rail.
- Derazi doors greater than 48" high will be two doors doweled together.

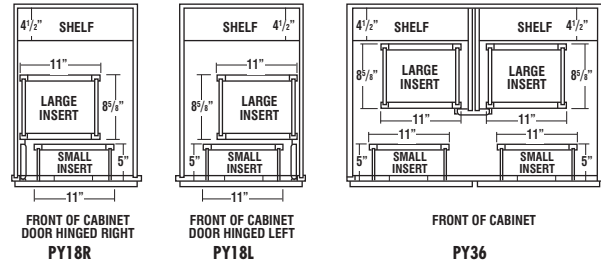

**Wood inserts for all styles:**

- Top view of wood inserts positioning and size.
- Wood inserts are 56" high.

Model	7	8	9	10	11	12	13	14	15	16	17	18
<b>PY188424 L or R</b>	2740	2740	2794	2901	2926	2981	3098	3111	3234	3320	3454	3588
<b>PY368424</b>	4893	4893	4986	5182	5226	5328	5535	5561	5789	5943	6186	6428

<b>PY188724 L or R</b>	2775	2775	2829	2937	2963	3018	3133	3148	3275	3360	3496	3633
<b>PY368724</b>	4904	4904	4998	5195	5239	5341	5550	5576	5804	5958	6201	6444

<b>PY189024AH L or R</b>	2811	2811	2863	2972	2998	3053	3171	3188	3314	3401	3539	3676
<b>PY369024AH</b>	4916	4916	5010	5205	5251	5354	5562	5591	5817	5970	6215	6459

**Custom Modifications**

ACS	ADDTK	AUTHL	AUTHR	CBO	CCO	CFNTO	CFRMO	CND	DRT	DRWTK	EXBKL	EXL	EXR	FB	FFDL	FFDR	FPEB	FTK	FTKAV	FTKPV	ID	INVFRM	MIP	RD	RECTKL	RECTKR	RT	TD	TKP	VTK	WLI	

**Construction Upgrades**

APC	ET	PE

**Door Options**

CG.TOP	DPSRR	MFO

**PANTRY UNIT, 84", 87", 90", 93", or 96" TALL, 24" DEEP (cont'd)**

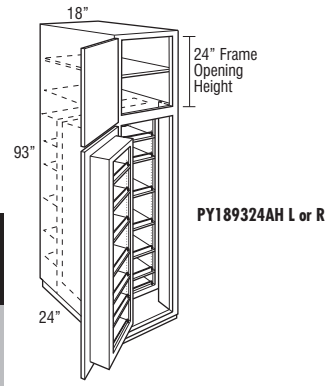

PY189324AH L or R

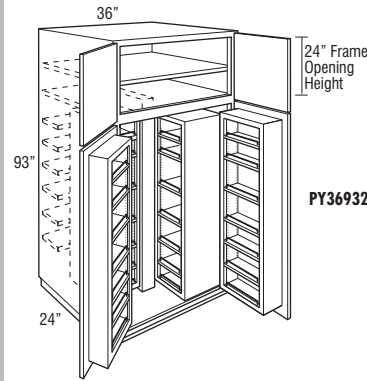

PY369324AH

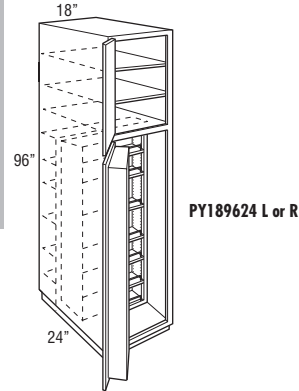

PY189624 L or R

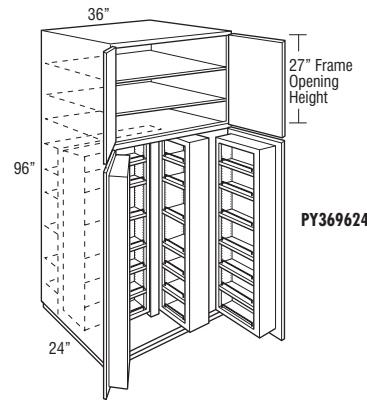

PY369624

Model	1	2	3	4	5	6
<b>PY189324AH L or R</b>	2068	2199	2451	2624	2610	2721
<b>PY369324AH</b>	3416	3633	4210	4512	4466	4670
<b>PY189624 L or R</b>	2068	2199	2451	2624	2610	2721
<b>PY369624</b>	3416	3633	4210	4512	4466	4670

- AH represents upper section alignment with doors on 24" or 27" high cabinets.
- Shelves on swing-out units, mounting rails, and door racks have a furniture board core with natural finish wood fronts and metallic finish wire rails. Door mounted rack includes 6 adjustable shelves and one fixed shelf. Swing-outs include 4 adjustable shelves and 3 fixed shelves. Swing-out and door racks included but shipped separately for field installation, includes mounting screws and installation instructions. Adjustable shelves for use in back of cabinet are 4 1/2" deep, six included.
- Separate pedestal base included but packaged separately on 93" tall. Pedestal is designed to create a Recessed Left or Right Toe-kick application during field installation, or can be centered. Pedestal must be covered with toeboard material.
- For PY18, use TF393 when installed against wall (or next to a full depth refrigerator.)
- Tall non-mitered doors will have two center panels with cross rail.
- Derazi doors greater than 48" high will be two doors doweled together.

- Shelves on swing-out units, mounting rails, and door racks have a furniture board core with natural finish wood fronts and metallic finish wire rails. Door mounted rack includes 6 adjustable shelves and one fixed shelf. Swing-outs include 4 adjustable shelves and 3 fixed shelves. Swing-out and door racks included but shipped separately for field installation, includes mounting screws and installation instructions. Adjustable shelves for use in back of cabinet are 4 1/2" deep, six included.
- Separate pedestal base included but packaged separately on 96" tall. Pedestal is designed to create a Recessed Left or Right Toe-kick application during field installation, or can be centered. Pedestal must be covered with toeboard material.
- For PY18, use TF396 when installed against wall (or next to a full depth refrigerator.)
- Tall non-mitered doors will have two center panels with cross rail.
- Derazi doors greater than 48" high will be two doors doweled together.

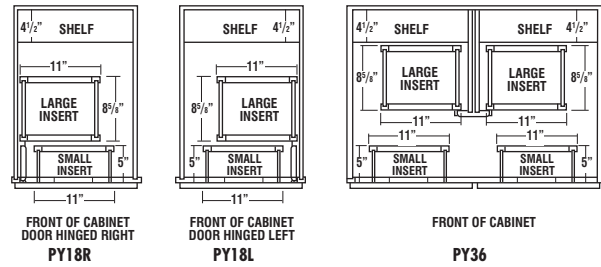

**Wood inserts for all styles:**

- Top view of wood inserts positioning and size.
- Wood inserts are 56" high.

Model	7	8	9	10	11	12	13	14	15	16	17	18
<b>PY189324AH L or R</b>	2876	2876	2930	3046	3070	3125	3247	3265	3397	3481	3619	3760
<b>PY369324AH</b>	4942	4942	5038	5237	5279	5383	5593	5617	5847	6006	6250	6496

<b>PY189624 L or R</b>	2876	2876	2930	3046	3070	3125	3247	3265	3397	3481	3619	3760
<b>PY369624</b>	4942	4942	5038	5237	5279	5383	5593	5617	5847	6006	6250	6496

**Custom Modifications**

ACS	ADDTK	AUTHL	AUTHR	CBO	CCO	CFNTD	CFRMO	CND	DRT	DRWTK	EXBKL	EXBKR	EXL	EXR	FB	FFDL	FFDR	FPEB	FTK	FTKAV	FTKFV	ID	INVFRM	MIP	RD	RECTKL	RECTKR	RT	TD	TKP	VTK	WLI		

**Construction Upgrades**

APC	ET	PE

**Door Options**

CG.TOP	DPSRR	MFO



**PANTRY WALK-THROUGH, 84", 87", 90", 93", or 96" TALL, 24" DEEP**

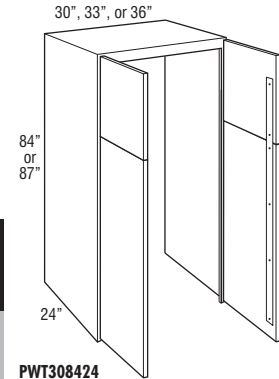

PWT308424  
PWT338424  
PWT368424

PWT308724  
PWT338724  
PWT368724

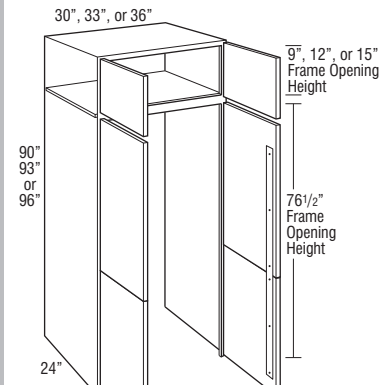

PWT309024  
PWT339024  
PWT369024

PWT309324  
PWT339324  
PWT369324

PWT309624  
PWT339624  
PWT369624

Model	1	2	3	4	5	6
PWT308424	2460	2574	2797	3139	3185	3314
PWT338424	2592	2718	2958	3326	3375	3510
PWT368424	2726	2865	3114	3510	3564	3709

PWT308724	2499	2617	2846	3234	3228	3361
PWT338724	2633	2763	3010	3430	3423	3562
PWT368724	2770	2911	3172	3622	3613	3760

PWT309024	2535	2658	2895	3332	3273	3405
PWT339024	2675	2808	3059	3533	3466	3611
PWT369024	2815	2959	3226	3732	3664	3813

PWT309324	2612	2741	2983	3521	3357	3494
PWT339324	2758	2896	3156	3737	3557	3704
PWT369324	2903	3050	3332	3951	3757	3913

PWT309624	2612	2741	2983	3521	3357	3494
PWT339624	2758	2896	3156	3737	3557	3704
PWT369624	2903	3050	3332	3951	3757	3913

- Cabinet does not have a bottom. 84" and 87" high do not have a back, 90"-96" high only have a back in the upper section. Doors are braced together, are 1/4" shorter than the cabinet for floor clearance, and use standard 107° Smart Stop hinges.
- Not available in Herra, Prestley Cherry, and Prestley Maple.
- Can be reduced in depth to 9" or increased in depth to 27".
- CG and glass inserts only available on upper doors of 90"-96" tall.
- Authentic Ends uses the standard tall door configuration by height and will not align with the front doors. A tall end panel skin can be used to conceal door attachment screws on the interior of the cabinet end panel (see TEPS\_WD on page 519).
- Height of ceiling needs to be considered for installation, 96" high cabinet requires 99" of height for 24" deep and 100" of height for 27" deep to stand unit upright.
- Cabinet will be shipped with additional attached supports to be removed during installation.
- ICM8 (Inside Corner Moulding) can be used to conceal staples behind the face frame.
- SSM8 (Small Scribe Moulding) can be used to conceal exposed back edges of the end panels, which are not edgebanded.
- End panels will not be drilled for shelves.
- If ordered in Arch style on 84" and 87" tall, the top doors of 84" and 87" will feature Arch profile. On 90"-96" tall, only the doors on the upper section will feature Arch profile.

	PO Door Height			FO Door Height			MFO Door Height		
	Top Door	Middle Door	Bottom Door	Top Door	Middle Door	Bottom Door	Top Door	Middle Door	Bottom Door
PWT308424	23 1/4"	N/A	59 1/2"	22 1/2"	N/A	61"	21 3/4"	N/A	61"
PWT338424	23 1/4"	N/A	59 1/2"	22 1/2"	N/A	61"	21 3/4"	N/A	61"
PWT368424	23 1/4"	N/A	59 1/2"	22 1/2"	N/A	61"	21 3/4"	N/A	61"
PWT308724	26 1/4"	N/A	59 1/2"	25 1/2"	N/A	61"	24 3/4"	N/A	61"
PWT338724	26 1/4"	N/A	59 1/2"	25 1/2"	N/A	61"	24 3/4"	N/A	61"
PWT368724	26 1/4"	N/A	59 1/2"	25 1/2"	N/A	61"	24 3/4"	N/A	61"
PWT309024	10"	43 1/2"	33 1/4"	11 1/2"	43 1/2"	34"	10 3/4"	43 1/2"	34"
PWT339024	10"	43 1/2"	33 1/4"	11 1/2"	43 1/2"	34"	10 3/4"	43 1/2"	34"
PWT369024	10"	43 1/2"	33 1/4"	11 1/2"	43 1/2"	34"	10 3/4"	43 1/2"	34"
PWT309324	13"	43 1/2"	33 1/4"	14 1/2"	43 1/2"	34"	13 3/4"	43 1/2"	34"
PWT339324	13"	43 1/2"	33 1/4"	14 1/2"	43 1/2"	34"	13 3/4"	43 1/2"	34"
PWT369324	13"	43 1/2"	33 1/4"	14 1/2"	43 1/2"	34"	13 3/4"	43 1/2"	34"
PWT309624	16"	43 1/2"	33 1/4"	17 1/2"	43 1/2"	34"	16 3/4"	43 1/2"	34"
PWT339624	16"	43 1/2"	33 1/4"	17 1/2"	43 1/2"	34"	16 3/4"	43 1/2"	34"
PWT369624	16"	43 1/2"	33 1/4"	17 1/2"	43 1/2"	34"	16 3/4"	43 1/2"	34"

Model	7	8	9	10	11	12	13	14	15	16	17	18
PWT308424	3387	3476	3530	3645	3669	3731	3854	3868	4003	4092	4235	4377
PWT338424	3592	3683	3742	3866	3893	3960	4091	4105	4249	4349	4500	4653
PWT368424	3796	3891	3957	4087	4116	4187	4326	4343	4495	4602	4765	4931

PWT308724	3491	3524	3581	3696	3722	3786	3910	3924	4061	4152	4299	4442
PWT338724	3705	3736	3797	3922	3950	4016	4150	4167	4312	4412	4566	4722
PWT368724	3918	3946	4013	4147	4175	4248	4389	4408	4562	4671	4836	5002

PWT309024	3597	3571	3631	3748	3775	3839	3965	3978	4118	4212	4359	4506
PWT339024	3817	3788	3849	3976	4007	4071	4210	4225	4374	4474	4633	4791
PWT369024	4039	4003	4069	4205	4234	4305	4450	4472	4631	4736	4905	5075

PWT309324	3808	3664	3723	3845	3874	3940	4070	4087	4227	4325	4478	4631
PWT339324	4044	3886	3951	4080	4112	4180	4321	4341	4492	4596	4761	4925
PWT369324	4277	4105	4176	4315	4350	4421	4572	4592	4755	4865	5042	5217

PWT309624	3808	3664	3723	3845	3874	3940	4070	4087	4227	4325	4478	4631
PWT339624	4044	3886	3951	4080	4112	4180	4321	4341	4492	4596	4761	4925
PWT369624	4277	4105	4176	4315	4350	4421	4572	4592	4755	4865	5042	5217

**Custom Modifications**

ACS	ADDTK	AUTHL	AUTHR	CBO	CCO	CFNTD	CFRMO	CND	DRT	DRWTK	EXBKL	EXBKR	EXL	EXR	FB	FFDL	FFDR	FPEB	FTK	FTKAV	FTKVV	ID	INVRM	MIP	RD	RECTKL	RECTKR	RT	TD	TKP	VTK	WLI	

**Construction Upgrades**

APC	ET	PE
STD		

**Door Options**

CG.TOP	DPSRR	MFO
• <sup>†</sup>	•	•

<sup>†</sup>Available only on 90"-96" high

**SINGLE OVEN CABINET,  
84", 87", or 90" TALL,  
24" DEEP**

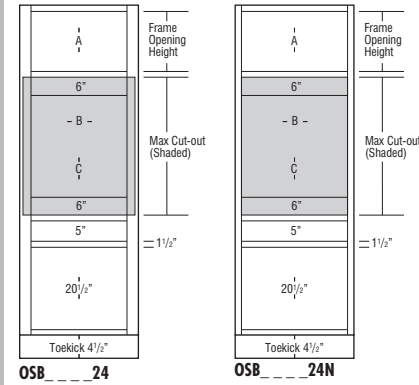
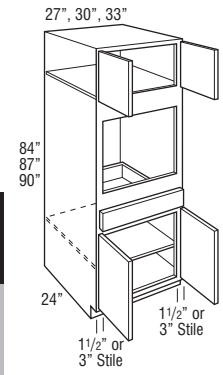

OSB 24

OSB 24N

Model	1	2	3	4	5	6
OSB278424(N)	1903	2001	2121	2444	2444	2444
OSB308424(N)	2002	2114	2214	2709	2683	2833
OSB338424(N)	2202	2325	2435	2980	2951	3116
OSB278724(N)	2099	2211	2390	2696	2690	2696
OSB308724(N)	2213	2338	2500	2948	2924	3092
OSB338724(N)	2434	2572	2750	3243	3216	3401
OSB279024(N)	2297	2422	2655	2948	2935	2948
OSB309024(N)	2424	2560	2786	3188	3163	3347
OSB339024(N)	2666	2816	3065	3507	3479	3682

- N represents Narrow Stile cabinets with 1 1/2" wide face frame side stiles and ACS modification availability (see page 50 for ACS specifications). Doors and drawer fronts have a consistent width reveal for full overlay (1/4") and partial overlay (1") and use standard Smart Stop hinges.
- On cabinets with 3" wide face frame side stiles, doors and drawer fronts have a consistent width reveal for full overlay (1/4") and partial overlay (1") and use face mount Smart Stop hinges. When CG is specified, face frame will be visible through door if used with a translucent art or textured glass design.
- Cabinets with 3" wide face frames are not available in Herra or MDF door styles.
- Base section will utilize a full depth shelf.
- All top and bottom cross rails are 1 1/2" wide.
- Be sure to confirm a heat shield is built into your appliance by the manufacturer or install the heat shield included with your appliance. Heat shields are sold separately as an accessory.
- Depth can be reduced to a minimum of 12".
- For built-in appliance support, OCINSTALLKIT is included in 24" deep oven cabinets (see page 582 for details). Oven install kit will not be included when depth is modified.
- OCINSTALLKIT weight limit is 400 lbs. per pair.
- Oven cabinets feature an open back in cut-out area designed to improve field appliance installation.
- Maximum cut-out dimension will allow 1/4" reveal for doors and drawer fronts on full overlay and 1" for partial overlay for trim kit face clearance.

	A Frame Opening Height	B Cut-out Width		C Cut-out Height		Door Height (Upper Section)	
		Min.	Max.	Min.	Max.	Partial Overlay	Full Overlay
OSB278424	15"	21"	25 1/2"	22 1/2"	31 1/2"	16"	17 1/2"
OSB308424	15"	24"	28 1/2"	22 1/2"	31 1/2"	16"	17 1/2"
OSB338424	15"	27"	31 1/2"	22 1/2"	31 1/2"	16"	17 1/2"
OSB278724	18"	21"	25 1/2"	22 1/2"	31 1/2"	19"	20 1/2"
OSB308724	18"	24"	28 1/2"	22 1/2"	31 1/2"	19"	20 1/2"
OSB338724	18"	27"	31 1/2"	22 1/2"	31 1/2"	19"	20 1/2"
OSB279024	21"	21"	25 1/2"	22 1/2"	31 1/2"	22"	23 1/2"
OSB309024	21"	24"	28 1/2"	22 1/2"	31 1/2"	22"	23 1/2"
OSB339024	21"	27"	31 1/2"	22 1/2"	31 1/2"	22"	23 1/2"

	A Frame Opening Height	B Cut-out Width (standard)		B Cut-out Width (with ACS modification)			C Cut-out Height		Door Height (Upper Section)	
		Min.	Max.	Min.	Max.	Max. w/ Field Cut	Min.	Max.	Partial Overlay	Full Overlay
OSB278424N	15"	24"	25 1/2"	21"	24"	25 1/2"	22 1/2"	31 1/2"	16"	17 1/2"
OSB308424N	15"	27"	28 1/2"	24"	27"	28 1/2"	22 1/2"	31 1/2"	16"	17 1/2"
OSB338424N	15"	30"	31 1/2"	27"	30"	31 1/2"	22 1/2"	31 1/2"	16"	17 1/2"
OSB278724N	18"	24"	25 1/2"	21"	24"	25 1/2"	22 1/2"	31 1/2"	19"	20 1/2"
OSB308724N	18"	27"	28 1/2"	24"	27"	28 1/2"	22 1/2"	31 1/2"	19"	20 1/2"
OSB338724N	18"	30"	31 1/2"	27"	30"	31 1/2"	22 1/2"	31 1/2"	19"	20 1/2"
OSB279024N	21"	24"	25 1/2"	21"	24"	25 1/2"	22 1/2"	31 1/2"	22"	23 1/2"
OSB309024N	21"	27"	28 1/2"	24"	27"	28 1/2"	22 1/2"	31 1/2"	22"	23 1/2"
OSB339024N	21"	30"	31 1/2"	27"	30"	31 1/2"	22 1/2"	31 1/2"	22"	23 1/2"

Model	7	8	9	10	11	12	13	14	15	16	17	18
OSB278424(N)	2582	2582	2628	2727	2750	2798	2903	2921	3035	3108	3230	3358
OSB308424(N)	2992	2992	3049	3164	3187	3245	3372	3387	3519	3610	3750	3901
OSB338424(N)	3291	3291	3354	3480	3506	3570	3709	3726	3871	3971	4125	4291
OSB278724(N)	2848	2848	2902	3009	3036	3093	3207	3223	3350	3433	3568	3710
OSB308724(N)	3265	3265	3326	3452	3480	3546	3682	3696	3843	3941	4097	4262
OSB338724(N)	3592	3592	3659	3797	3828	3901	4050	4066	4227	4335	4507	4688
OSB279024(N)	3112	3112	3173	3292	3318	3383	3509	3523	3665	3756	3904	4062
OSB309024(N)	3538	3538	3605	3740	3772	3843	3990	4006	4166	4274	4444	4624
OSB339024(N)	3892	3892	3966	4114	4149	4227	4389	4407	4583	4701	4888	5086

**Custom Modifications**

ACS	ADDTK	AUTHL AUTHR	CBO	CCO	CFNTO	CFRMO	CND	DRT	DRWTK	EXBKL EXBKR	EXL EXR	FB	FFDL	FFDR	FPEB	FTK	FTKAV FTKRV	ID	INVRM	MIP	RD	RECTKL RECTKR	RT	TD	TKP	VTK	WLI
•*		•	•	•	•	•	•		•	•	•	•			•	•	•			•	•	•	•	•	•	•	•

\*Only available on Narrow Stile (N) cabinets

**Construction Upgrades**

APC	ET	PE
•		•

**Door Options**

CG.TOP	DPSRR	MFO
•	•	•

**SINGLE OVEN CABINET,  
93" or 96" TALL, 24" DEEP**

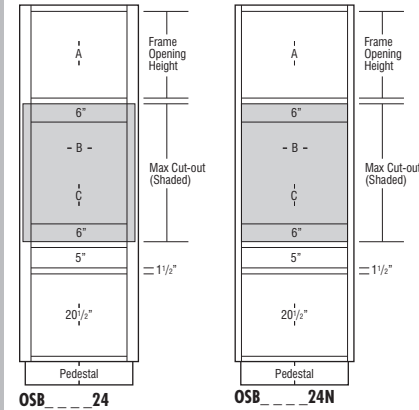
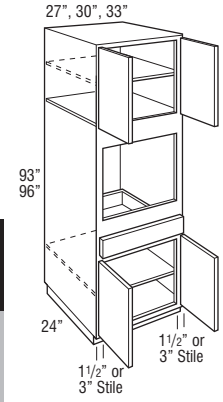

OSB 24 OSB 24N

Model	1	2	3	4	5	6
OSB279324(N)	2692	2840	3187	3427	3387	3445
OSB309324(N)	2841	3007	3354	3676	3637	3863
OSB339324(N)	3125	3308	3689	4044	4001	4249

OSB279624(N)	2692	2840	3187	3427	3387	3445
OSB309624(N)	2841	3007	3354	3676	3637	3863
OSB339624(N)	3125	3308	3689	4044	4001	4249

- N represents Narrow Stile cabinets with 1 1/2" wide face frame side stiles and ACS modification availability (see page 50 for ACS specifications). Doors and drawer fronts have a consistent width reveal for full overlay (1/4") and partial overlay (1") and use standard Smart Stop hinges.
- On cabinets with 3" wide face frame side stiles, doors and drawer fronts have a consistent width reveal for full overlay (1/4") and partial overlay (1") and use face mount Smart Stop hinges. When CG is specified, face frame will be visible through door if used with a translucent art or textured glass design.
- Cabinets with 3" wide face frames are not available in Herra or MDF door styles.
- Base section will utilize a full depth shelf.
- Includes adjustable shelves in upper section:  
93" tall - one shelf  
96" tall - two shelves
- All top and bottom cross rails are 1 1/2" wide.
- Be sure to confirm a heat shield is built into your appliance by the manufacturer or install the heat shield included with your appliance. Heat shields are sold separately as an accessory.
- Separate pedestal base included, but packaged separately. Pedestal is designed to create a Recessed Left or Right Toekick application during field installation, or can be centered. Pedestal must be covered with toeboard material.
- Depth can be reduced to a minimum of 12".
- For built-in appliance support, OCINSTALLKIT is included in 24" deep oven cabinets (see page 582 for details). Oven install kit will not be included when depth is modified.
- OCINSTALLKIT weight limit is 400 lbs. per pair.
- Oven cabinets feature an open back in cut-out area designed to improve field appliance installation.
- Maximum cut-out dimension will allow 1/4" reveal for doors and drawer fronts on full overlay and 1" for partial overlay for trim kit face clearance.

	A Frame Opening Height	B Cut-out Width		C Cut-out Height		Door Height (Upper Section)	
		Min.	Max.	Min.	Max.	Partial Overlay	Full Overlay
OSB279324	24"	21"	25 1/2"	22 1/2"	31 1/2"	25"	26 1/2"
OSB309324	24"	24"	28 1/2"	22 1/2"	31 1/2"	25"	26 1/2"
OSB339324	24"	27"	31 1/2"	22 1/2"	31 1/2"	25"	26 1/2"
OSB279624	27"	21"	25 1/2"	22 1/2"	31 1/2"	28"	29 1/2"
OSB309624	27"	24"	28 1/2"	22 1/2"	31 1/2"	28"	29 1/2"
OSB339624	27"	27"	31 1/2"	22 1/2"	31 1/2"	28"	29 1/2"

	A Frame Opening Height	B Cut-out Width (standard)		B Cut-out Width (with ACS modification)			C Cut-out Height		Door Height (Upper Section)	
		Min.	Max.	Min.	Max.	Max. w/ Field Cut	Min.	Max.	Partial Overlay	Full Overlay
OSB279324N	24"	24"	25 1/2"	21"	24"	25 1/2"	22 1/2"	31 1/2"	25"	26 1/2"
OSB309324N	24"	27"	28 1/2"	24"	27"	28 1/2"	22 1/2"	31 1/2"	25"	26 1/2"
OSB339324N	24"	30"	31 1/2"	27"	30"	31 1/2"	22 1/2"	31 1/2"	25"	26 1/2"
OSB279624N	27"	24"	25 1/2"	21"	24"	25 1/2"	22 1/2"	31 1/2"	28"	29 1/2"
OSB309624N	27"	27"	28 1/2"	24"	27"	28 1/2"	22 1/2"	31 1/2"	28"	29 1/2"
OSB339624N	27"	30"	31 1/2"	27"	30"	31 1/2"	22 1/2"	31 1/2"	28"	29 1/2"

Model	7	8	9	10	11	12	13	14	15	16	17	18
OSB279324(N)	3641	3641	3711	3853	3884	3957	4107	4128	4292	4404	4578	4763
OSB309324(N)	4084	4084	4162	4320	4356	4440	4608	4632	4818	4943	5143	5346
OSB339324(N)	4492	4492	4578	4752	4792	4884	5069	5095	5300	5437	5657	5881

OSB279624(N)	3641	3641	3711	3853	3884	3957	4107	4128	4292	4404	4578	4763
OSB309624(N)	4084	4084	4162	4320	4356	4440	4608	4632	4818	4943	5143	5346
OSB339624(N)	4492	4492	4578	4752	4792	4884	5069	5095	5300	5437	5657	5881

**Custom Modifications**

ACS	ADDTK	AUTHL AUTHR	CBO	CCO	CFNTO	CFRMO	CND	DRT	DRWTK	EXBKL EXBKR	EXL EXR	FB	FFDL FFDR	FPEB	FTK	FTKAV FTKRV	ID	INVFRM	MIP	RD	RECTKL RECTKR	RT	TD	TKP	VTK	WLI
•*		•	•	•	•	•	•			•	•	•		•					•	•	•	•				•

\*Only available on Narrow Stile (N) cabinets

**Construction Upgrades**

APC	ET	PE
•		•

**Door Options**

CG.TOP	DPSRR	MFO
•	•	•

**OVEN MICROWAVE COMBO CABINET,  
84", 87", or 90" TALL, 24" DEEP**

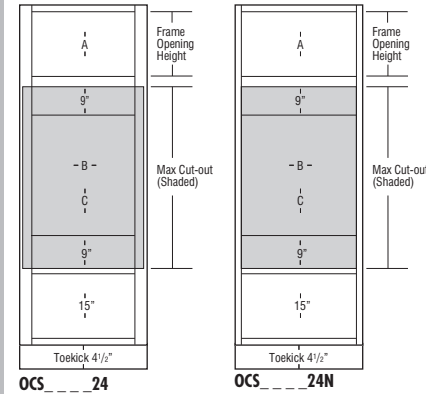
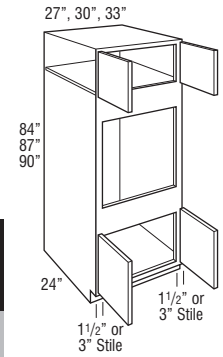

OCS \_\_\_ 24

OCS \_\_\_ 24N

Model	1	2	3	4	5	6
<b>OCS278424(N)</b>	1545	1632	1744	2089	2187	2147
<b>OCS308424(N)</b>	1633	1735	1827	2273	2388	2499
<b>OCS338424(N)</b>	1915	2036	2090	2465	2611	2730
<b>OCS278724(N)</b>	1722	1824	1984	2299	2404	2377
<b>OCS308724(N)</b>	1825	1938	2087	2492	2614	2732
<b>OCS338724(N)</b>	2116	2248	2363	2720	2872	3000
<b>OCS279024(AH or N)</b>	1901	2012	2226	2508	2619	2607
<b>OCS309024(AH or N)</b>	2013	2140	2346	2711	2839	2966
<b>OCS339024(AH or N)</b>	2314	2460	2636	2973	3130	3270

- AH represents upper section alignment with doors on 24" or 27" high cabinets.
- N represents Narrow Stile cabinets with 1 1/2" wide face frame side stiles and ACS modification availability (see page 50 for ACS specifications). Doors have a consistent width reveal for full overlay (1/4") and partial overlay (1") and use standard Smart Stop hinges.
- On cabinets with 3" wide face frame side stiles, full overlay styles have a consistent 1/4" width frame reveal and use face mounted Smart Stop hinges. Partial overlay styles have a larger 2 1/2" width reveal, use standard Smart Stop hinges, and are not recommended for stacking applications due to misalignment of door width with cabinets above.
- Upper section on 90" tall has one full depth adjustable shelf.
- All top and bottom cross rails are 1 1/2" wide.
- Be sure to confirm a heat shield is built into your appliance by the manufacturer or install the heat shield included with your appliance. Heat shields are sold separately as an accessory.
- Depth can be reduced to a minimum of 6". For depths of 6"-8", cabinet will not include toe kick/pedestal.
- For built-in appliance support, OCINSTALLKIT is included in 24" deep oven cabinets (see page 582 for details). Oven install kit will not be included when depth is modified.
- OCINSTALLKIT weight limit is 400 lbs. per pair.
- Oven cabinets feature an open back in cut-out area designed to improve field appliance installation.
- Maximum cut-out dimension will allow 1/4" reveal for doors and drawer fronts on full overlay and 1" for partial overlay for trim kit face clearance.

	A Frame Opening Height	B Cut-out Width		C Cut-out Height		Door Height (Upper Section)	
		Min.	Max.	Min.	Max.	Partial Overlay	Full Overlay
OCS278424	15"	21"	25 1/2"	28 1/2"	43 1/2"	16"	17 1/2"
OCS308424	15"	24"	28 1/2"	28 1/2"	43 1/2"	16"	17 1/2"
OCS338424	15"	27"	31 1/2"	28 1/2"	43 1/2"	16"	17 1/2"
OCS278724	18"	21"	25 1/2"	28 1/2"	43 1/2"	19"	20 1/2"
OCS308724	18"	24"	28 1/2"	28 1/2"	43 1/2"	19"	20 1/2"
OCS338724	18"	27"	31 1/2"	28 1/2"	43 1/2"	19"	20 1/2"
OCS279024AH	21"	21"	25 1/2"	28 1/2"	43 1/2"	22"	23 1/2"
OCS309024AH	21"	24"	28 1/2"	28 1/2"	43 1/2"	22"	23 1/2"
OCS339024AH	21"	27"	31 1/2"	28 1/2"	43 1/2"	22"	23 1/2"

	A Frame Opening Height	B Cut-out Width (standard)		B Cut-out Width (with ACS modification)			C Cut-out Height		Door Height (Upper Section)	
		Min.	Max.	Min.	Max.	Max. w/ Field Cut	Min.	Max.	Partial Overlay	Full Overlay
OCS278424N	15"	24"	25 1/2"	21"	24"	25 1/2"	28 1/2"	43 1/2"	16"	17 1/2"
OCS308424N	15"	27"	28 1/2"	24"	27"	28 1/2"	28 1/2"	43 1/2"	16"	17 1/2"
OCS338424N	15"	30"	31 1/2"	27"	30"	31 1/2"	28 1/2"	43 1/2"	16"	17 1/2"
OCS278724N	18"	24"	25 1/2"	21"	24"	25 1/2"	28 1/2"	43 1/2"	19"	20 1/2"
OCS308724N	18"	27"	28 1/2"	24"	27"	28 1/2"	28 1/2"	43 1/2"	19"	20 1/2"
OCS338724N	18"	30"	31 1/2"	27"	30"	31 1/2"	28 1/2"	43 1/2"	19"	20 1/2"
OCS279024N	21"	24"	25 1/2"	21"	24"	25 1/2"	28 1/2"	43 1/2"	22"	23 1/2"
OCS309024N	21"	27"	28 1/2"	24"	27"	28 1/2"	28 1/2"	43 1/2"	22"	23 1/2"
OCS339024N	21"	30"	31 1/2"	27"	30"	31 1/2"	28 1/2"	43 1/2"	22"	23 1/2"

Model	7	8	9	10	11	12	13	14	15	16	17	18
<b>OCS278424(N)</b>	2273	2273	2316	2405	2426	2473	2569	2581	2683	2757	2868	2981
<b>OCS308424(N)</b>	2643	2643	2694	2799	2823	2879	2991	3004	3125	3207	3340	3471
<b>OCS338424(N)</b>	2887	2887	2943	3057	3083	3144	3268	3284	3416	3507	3648	3794
<b>OCS278724(N)</b>	2514	2514	2563	2663	2683	2735	2843	2854	2971	3051	3174	3300
<b>OCS308724(N)</b>	2891	2891	2947	3063	3089	3148	3273	3287	3420	3510	3652	3800
<b>OCS338724(N)</b>	3175	3175	3235	3362	3392	3458	3594	3608	3755	3858	4014	4174
<b>OCS279024(AH or N)</b>	2757	2757	2811	2918	2942	2999	3117	3131	3257	3346	3481	3618
<b>OCS309024(AH or N)</b>	3140	3140	3199	3325	3352	3419	3553	3568	3713	3811	3966	4124
<b>OCS339024(AH or N)</b>	3461	3461	3527	3666	3697	3771	3919	3934	4094	4210	4380	4555

**Custom Modifications**

ACS	ADDTK	AUTHL AUTHR	CBO	CCO	CFNTO	CFRMO	CND	DRT	DRWTK	EXBKL EXBKR	EXL EXR	FB	FFDL	FFDR	FPEB	FTK	FTKAV FTKRV	ID	INVFRM	MIP	RD	RECTKL RECTKR	RT	TD	TKP	VTK	WLI
•*		•	•	•	•	•			•	•	•	•			•	•	•	•		•	•	•		•	•	•	•

\*Only available on Narrow Stile (N) cabinets \*Not available on 84" and 87" tall

**Construction Upgrades**

APC	ET	PE
•		•

**Door Options**

CG.TOP	DPSRR	MFO
	•	•

**OVEN MICROWAVE COMBO CABINET,  
93" or 96" TALL, 24" DEEP**

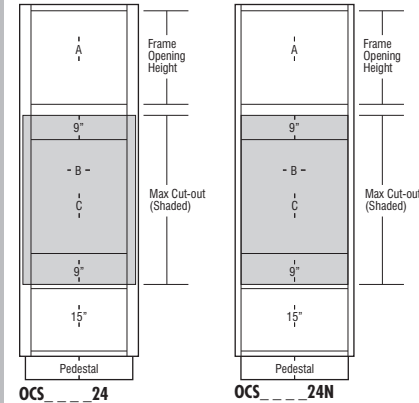
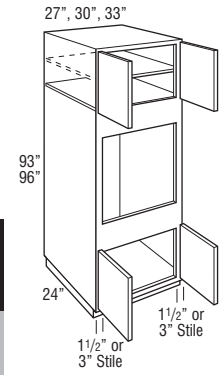

Model	1	2	3	4	5	6
<b>OCS279324(AH or N)</b>	2262	2393	2710	2927	3048	3056
<b>OCS309324(AH or N)</b>	2394	2546	2863	3153	3291	3435
<b>OCS339324(AH or N)</b>	2709	2880	3176	3485	3652	3813
<hr/>						
<b>OCS279624(N)</b>	2262	2393	2710	2927	3048	3056
<b>OCS309624(N)</b>	2394	2546	2863	3153	3291	3435
<b>OCS339624(N)</b>	2709	2880	3176	3485	3652	3813

- AH represents upper section alignment with doors on 24" or 27" high cabinets.
- N represents Narrow Stile cabinets with 1 1/2" wide face frame side stiles and ACS modification availability (see page 50 for ACS specifications). Doors have a consistent width reveal for full overlay (1/4") and partial overlay (1") and use standard Smart Stop hinges.
- On cabinets with 3" wide face frame side stiles, full overlay styles have a consistent 1/4" width frame reveal and use face mounted Smart Stop hinges. Partial overlay styles have a larger 2 1/2" width reveal, use standard Smart Stop hinges, and are not recommended for stacking applications due to misalignment of door width with cabinets above.
- Includes adjustable shelves in upper section:  
93" tall - one shelf  
96" tall - two shelves
- All top and bottom cross rails are 1 1/2" wide.
- Be sure to confirm a heat shield is built into your appliance by the manufacturer or install the heat shield included with your appliance. Heat shields are sold separately as an accessory.
- Separate pedestal base included but packaged separately on 93" and 96" tall. Pedestal is designed to create a Recessed Left or Right Toekick application during field installation, or can be centered. Pedestal must be covered with toeboard material.
- Depth can be reduced to a minimum of 6". For depths of 6"-8", cabinet will not include toekick/pedestal.
- For built-in appliance support, OCINSTALKIT is included in 24" deep oven cabinets (see page 582 for details). Oven install kit will not be included when depth is modified.
- OCINSTALKIT weight limit is 400 lbs. per pair.
- Oven cabinets feature an open back in cut-out area designed to improve field appliance installation.
- Maximum cut-out dimension will allow 1/4" reveal for doors and drawer fronts on full overlay and 1" for partial overlay for trim kit face clearance.

	A Frame Opening Height	B Cut-out Width		C Cut-out Height		Door Height (Upper Section)	
		Min.	Max.	Min.	Max.	Partial Overlay	Full Overlay
		OCS279324AH	24"	21"	25 1/2"	28 1/2"	43 1/2"
OCS309324AH	24"	24"	28 1/2"	28 1/2"	43 1/2"	25"	26 1/2"
OCS339324AH	24"	27"	31 1/2"	28 1/2"	43 1/2"	25"	26 1/2"
OCS279624	27"	21"	25 1/2"	28 1/2"	43 1/2"	28"	29 1/2"
OCS309624	27"	24"	28 1/2"	28 1/2"	43 1/2"	28"	29 1/2"
OCS339624	27"	27"	31 1/2"	28 1/2"	43 1/2"	28"	29 1/2"

	A Frame Opening Height	B Cut-out Width (standard)		B Cut-out Width (with ACS modification)			C Cut-out Height		Door Height (Upper Section)	
		Min.	Max.	Min.	Max.	Max. w/ Field Cut	Min.	Max.	Partial Overlay	Full Overlay
		OCS279324N	24"	24"	25 1/2"	21"	24"	25 1/2"	28 1/2"	43 1/2"
OCS309324N	24"	27"	28 1/2"	24"	27"	28 1/2"	28 1/2"	43 1/2"	25"	26 1/2"
OCS339324N	24"	30"	31 1/2"	27"	30"	31 1/2"	28 1/2"	43 1/2"	25"	26 1/2"
OCS279624N	27"	24"	25 1/2"	21"	24"	25 1/2"	28 1/2"	43 1/2"	28"	29 1/2"
OCS309624N	27"	27"	28 1/2"	24"	27"	28 1/2"	28 1/2"	43 1/2"	28"	29 1/2"
OCS339624N	27"	30"	31 1/2"	27"	30"	31 1/2"	28 1/2"	43 1/2"	28"	29 1/2"

Model	7	8	9	10	11	12	13	14	15	16	17	18
<b>OCS279324(AH or N)</b>	3235	3235	3298	3426	3457	3521	3658	3678	3827	3929	4089	4253
<b>OCS309324(AH or N)</b>	3637	3637	3709	3854	3884	3960	4117	4134	4306	4420	4600	4783
<b>OCS339324(AH or N)</b>	4036	4036	4118	4280	4316	4399	4572	4593	4781	4910	5111	5315
<hr/>												
<b>OCS279624(N)</b>	3235	3235	3298	3426	3457	3521	3658	3678	3827	3929	4089	4253
<b>OCS309624(N)</b>	3637	3637	3709	3854	3884	3960	4117	4134	4306	4420	4600	4783
<b>OCS339624(N)</b>	4036	4036	4118	4280	4316	4399	4572	4593	4781	4910	5111	5315

**Custom Modifications**

ACS	ADDTK	AUTHL AUTHR	CBO	CCO	CFNTO	CFRMO	CND	DRT	DRWTK	EXBKL EXBKR	EXL EXR	FB	FFDL FFDR	FPEB	FTK	FTKAV FTKRV	ID	INVFRM	MIP	RD	RECTKL RECTKR	RT	TD	TKP	VTK	WLI
•*		•	•	•	•	•				•	•	•		•			•		•	•	•		•			•

\*Only available on Narrow Stile (N) cabinets

**Construction Upgrades**

APC	ET	PE
•		•

**Door Options**

CG.TOP	DPSRR	MFO
	•	•

**OVEN MICROWAVE COMBO CABINET,  
DEEP DRAWER, 84", 87", or 90"  
TALL, 24" DEEP**

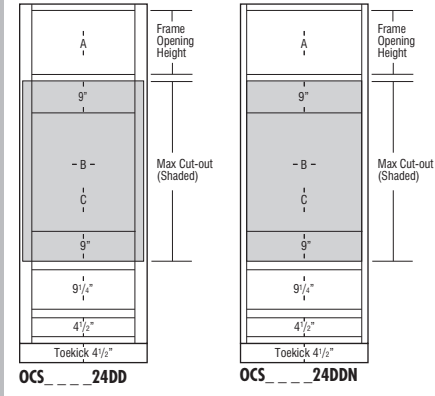
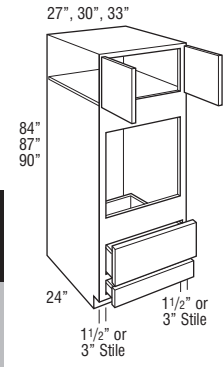

TALL CABINETS

Model	1	2	3	4	5	6
<b>OCS278424DD(N)</b>	2250	2347	2472	2815	2815	2815
<b>OCS308424DD(N)</b>	2435	2548	2646	3141	3269	3291
<b>OCS338424DD(N)</b>	2861	2997	3055	3463	3629	3658
<b>OCS278724DD(N)</b>	2446	2558	2737	3063	3066	3066
<b>OCS308724DD(N)</b>	2645	2771	2935	3380	3517	3547
<b>OCS338724DD(N)</b>	3080	3227	3355	3745	3912	3956
<b>OCS279024DD(AH or N)</b>	2644	2767	3002	3311	3318	3318
<b>OCS309024DD(AH or N)</b>	2855	2995	3221	3623	3763	3803
<b>OCS339024DD(AH or N)</b>	3300	3459	3654	4027	4197	4255

- AH represents upper section alignment with doors on 24" or 27" high cabinets.
- N represents Narrow Stile cabinets with 1 1/2" wide face frame side stiles and ACS modification availability (see page 50 for ACS specifications). Doors and drawer fronts have a consistent width reveal for full overlay (1/4") and partial overlay (1") and use standard Smart Stop hinges.
- On cabinets with 3" wide face frame side stiles, full overlay styles have a consistent 1/4" width frame reveal and use face mounted Smart Stop hinges. Partial overlay styles have a larger 2 1/2" width reveal, use standard Smart Stop hinges, and are not recommended for stacking applications due to misalignment of door width with cabinets above.
- Cabinets with 3" wide face frames are not available in MDF door styles.
- Upper section on 90" tall has one full depth adjustable shelf.
- All top and bottom cross rails are 1 1/2" wide.
- Be sure to confirm a heat shield is built into your appliance by the manufacturer or install the heat shield included with your appliance. Heat shields are sold separately as an accessory.
- Depth can be reduced to a minimum of 12".
- For built-in appliance support, OCINSTALKIT is included in 24" deep oven cabinets (see page 582 for details). Oven install kit will not be included when depth is modified.
- OCINSTALKIT weight limit is 400 lbs. per pair.
- Oven cabinets feature an open back in cut-out area designed to improve field appliance installation.
- Maximum cut-out dimension will allow 1/4" reveal for doors and drawer fronts on full overlay and 1" for partial overlay for trim kit face clearance.

	A Frame Opening Height	B Cut-out Width		C Cut-out Height		Door Height (Upper Section)	
		Min.	Max.	Min.	Max.	Partial Overlay	Full Overlay
OCS278424DD	15"	21"	25 1/2"	27 3/4"	42 3/4"	16"	17 1/2"
OCS308424DD	15"	24"	28 1/2"	27 3/4"	42 3/4"	16"	17 1/2"
OCS338424DD	15"	27"	31 1/2"	27 3/4"	42 3/4"	16"	17 1/2"
OCS278724DD	18"	21"	25 1/2"	27 3/4"	42 3/4"	19"	20 1/2"
OCS308724DD	18"	24"	28 1/2"	27 3/4"	42 3/4"	19"	20 1/2"
OCS338724DD	18"	27"	31 1/2"	27 3/4"	42 3/4"	19"	20 1/2"
OCS279024DDAH	21"	21"	25 1/2"	27 3/4"	42 3/4"	22"	23 1/2"
OCS309024DDAH	21"	24"	28 1/2"	27 3/4"	42 3/4"	22"	23 1/2"
OCS339024DDAH	21"	27"	31 1/2"	27 3/4"	42 3/4"	22"	23 1/2"

	A Frame Opening Height	B Cut-out Width (standard)		B Cut-out Width (with ACS modification)			C Cut-out Height		Door Height (Upper Section)	
		Min.	Max.	Min.	Max.	Max. w/ Field Cut	Min.	Max.	Partial Overlay	Full Overlay
OCS278424DDN	15"	24"	25 1/2"	21"	24"	25 1/2"	27 3/4"	42 3/4"	16"	17 1/2"
OCS308424DDN	15"	27"	28 1/2"	24"	27"	28 1/2"	27 3/4"	42 3/4"	16"	17 1/2"
OCS338424DDN	15"	30"	31 1/2"	27"	30"	31 1/2"	27 3/4"	42 3/4"	16"	17 1/2"
OCS278724DDN	18"	24"	25 1/2"	21"	24"	25 1/2"	27 3/4"	42 3/4"	19"	20 1/2"
OCS308724DDN	18"	27"	28 1/2"	24"	27"	28 1/2"	27 3/4"	42 3/4"	19"	20 1/2"
OCS338724DDN	18"	30"	31 1/2"	27"	30"	31 1/2"	27 3/4"	42 3/4"	19"	20 1/2"
OCS279024DDN	21"	24"	25 1/2"	21"	24"	25 1/2"	27 3/4"	42 3/4"	22"	23 1/2"
OCS309024DDN	21"	27"	28 1/2"	24"	27"	28 1/2"	27 3/4"	42 3/4"	22"	23 1/2"
OCS339024DDN	21"	30"	31 1/2"	27"	30"	31 1/2"	27 3/4"	42 3/4"	22"	23 1/2"

Model	7	8	9	10	11	12	13	14	15	16	17	18
<b>OCS278424DD(N)</b>	2954	2954	3001	3101	3120	3172	3279	3292	3405	3484	3605	3739
<b>OCS308424DD(N)</b>	3449	3449	3505	3624	3645	3707	3829	3843	3979	4068	4214	4367
<b>OCS338424DD(N)</b>	3833	3833	3893	4020	4048	4113	4247	4267	4413	4513	4670	4835
<b>OCS278724DD(N)</b>	3220	3220	3273	3382	3405	3463	3582	3595	3722	3808	3944	4092
<b>OCS308724DD(N)</b>	3722	3722	3781	3911	3936	4005	4139	4155	4301	4399	4559	4726
<b>OCS338724DD(N)</b>	4147	4147	4215	4356	4387	4459	4608	4624	4786	4899	5070	5255
<b>OCS279024DD(AH or N)</b>	3484	3484	3544	3664	3689	3753	3882	3897	4036	4133	4283	4443
<b>OCS309024DD(AH or N)</b>	3992	3992	4061	4197	4228	4299	4447	4466	4626	4732	4903	5083
<b>OCS339024DD(AH or N)</b>	4462	4462	4535	4690	4722	4802	4966	4982	5158	5284	5473	5670

**Custom Modifications**

ACS	ADDTK	AUTHL AUTHR	CBO	CCO	CFNTO	CFRMO	CND	DRT	DRWTK	EXBKL EXBKR	EXL EXR	FB	FFDL	FPEB	FTK	FTKAV FTKAV	ID	INFRM	MIP	RD	RECTKL RECTKR	RT	TD	TKP	VTK	WLI
•*		•	•	•		•	•		•	•	•	•		•	•	•			•	•	•		•	•	•	•

\*Only available on Narrow Stile (N) cabinets

**Construction Upgrades**

APC	ET	PE
•		•

**Door Options**

CG.TOP	DPSRR	MFO
	•	•

TALL CABINETS

**OVEN MICROWAVE COMBO CABINET,  
DEEP DRAWER, 93" or 96" TALL,  
24" DEEP**

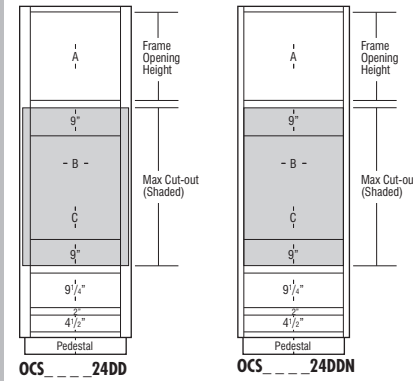
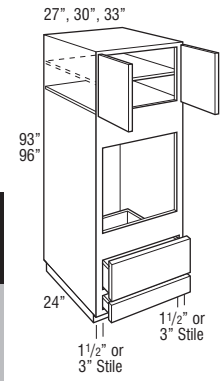

Model	1	2	3	4	5	6
<b>OCS279324DD(AH or N)</b>	3041	3189	3532	3773	3815	3815
<b>OCS309324DD(AH or N)</b>	3276	3443	3789	4109	4259	4320
<b>OCS339324DD(AH or N)</b>	3734	3926	4251	4589	4773	4851

<b>OCS279624DD(N)</b>	3041	3189	3532	3773	3815	3815
<b>OCS309624DD(N)</b>	3276	3443	3789	4109	4259	4320
<b>OCS339624DD(N)</b>	3734	3926	4251	4589	4773	4851

- AH represents upper section alignment with doors on 24" or 27" high cabinets.
- N represents Narrow Stile cabinets with 1 1/2" wide face frame side stiles and ACS modification availability (see page 50 for ACS specifications). Doors and drawer fronts have a consistent width reveal for full overlay (1/4") and partial overlay (1") and use standard Smart Stop hinges.
- On cabinets with 3" wide face frame side stiles, full overlay styles have a consistent 1/4" width frame reveal and use face mounted Smart Stop hinges. Partial overlay styles have a larger 2 1/2" width reveal, use standard Smart Stop hinges, and are not recommended for stacking applications due to misalignment of door width with cabinets above.
- Cabinets with 3" wide face frames are not available in MDF door styles.
- Includes adjustable shelves in upper section:  
93" tall - one shelf  
96" tall - two shelves
- All top and bottom cross rails are 1 1/2" wide.
- Be sure to confirm a heat shield is built into your appliance by the manufacturer or install the heat shield included with your appliance. Heat shields are sold separately as an accessory.
- Separate pedestal base included but packaged separately on 93" and 96" tall. Pedestal is designed to create a Recessed Left or Right Toe Kick application during field installation, or can be centered. Pedestal must be covered with toeboard material.
- Depth can be reduced to a minimum of 12".
- For built-in appliance support, OCINSTALLKIT is included in 24" deep oven cabinets (see page 582 for details). Oven install kit will not be included when depth is modified.
- OCINSTALLKIT weight limit is 400 lbs. per pair.
- Oven cabinets feature an open back in cut-out area designed to improve field appliance installation.
- Maximum cut-out dimension will allow 1/4" reveal for doors and drawer fronts on full overlay and 1" for partial overlay for trim kit face clearance.

	A Frame Opening Height	B Cut-out Width		C Cut-out Height		Door Height (Upper Section)	
		Min.	Max.	Min.	Max.	Partial Overlay	Full Overlay
OCS279324DDAH	24"	21"	25 1/2"	27 3/4"	42 3/4"	25"	26 1/2"
OCS309324DDAH	24"	24"	28 1/2"	27 3/4"	42 3/4"	25"	26 1/2"
OCS339324DDAH	24"	27"	31 1/2"	27 3/4"	42 3/4"	25"	26 1/2"
OCS279624DD	27"	21"	25 1/2"	27 3/4"	42 3/4"	28"	29 1/2"
OCS309624DD	27"	24"	28 1/2"	27 3/4"	42 3/4"	28"	29 1/2"
OCS339624DD	27"	27"	31 1/2"	27 3/4"	42 3/4"	28"	29 1/2"

	A Frame Opening Height	B Cut-out Width (standard)		B Cut-out Width (with ACS modification)			C Cut-out Height		Door Height (Upper Section)	
		Min.	Max.	Min.	Max.	Max. w/ Field Cut	Min.	Max.	Partial Overlay	Full Overlay
OCS279324DDN	24"	24"	25 1/2"	21"	24"	25 1/2"	27 3/4"	42 3/4"	25"	26 1/2"
OCS309324DDN	24"	27"	28 1/2"	24"	27"	28 1/2"	27 3/4"	42 3/4"	25"	26 1/2"
OCS339324DDN	24"	30"	31 1/2"	27"	30"	31 1/2"	27 3/4"	42 3/4"	25"	26 1/2"
OCS279624DDN	27"	24"	25 1/2"	21"	24"	25 1/2"	27 3/4"	42 3/4"	28"	29 1/2"
OCS309624DDN	27"	27"	28 1/2"	24"	27"	28 1/2"	27 3/4"	42 3/4"	28"	29 1/2"
OCS339624DDN	27"	30"	31 1/2"	27"	30"	31 1/2"	27 3/4"	42 3/4"	28"	29 1/2"

Model	7	8	9	10	11	12	13	14	15	16	17	18
<b>OCS279324DD(AH or N)</b>	4013	4013	4082	4220	4256	4327	4477	4499	4664	4776	4951	5138
<b>OCS309324DD(AH or N)</b>	4540	4540	4621	4777	4814	4896	5068	5089	5274	5401	5599	5808
<b>OCS339324DD(AH or N)</b>	5096	5096	5186	5362	5402	5496	5687	5708	5915	6059	6278	6511

<b>OCS279624DD(N)</b>	4013	4013	4082	4220	4256	4327	4477	4499	4664	4776	4951	5138
<b>OCS309624DD(N)</b>	4540	4540	4621	4777	4814	4896	5068	5089	5274	5401	5599	5808
<b>OCS339624DD(N)</b>	5096	5096	5186	5362	5402	5496	5687	5708	5915	6059	6278	6511

**Custom Modifications**

ACS	ADDTK	AUTHL AUTHR	CBO	CCO	CFNTO	CFRMO	CND	DRT	DRWTK	EXBKL EXBKR	EXL EXR	FB	FFDL FFDR	FPEB	FTK	FTKAV FTKRV	ID	INVRM	MIP	RD	RECTKL RECTKR	RT	TD	TKP	VTK	WLI
•*		•	•	•		•	•			•	•	•		•					•	•	•		•			•

\*Only available on Narrow Stile (N) cabinets

**Construction Upgrades**

APC	ET	PE
•		•

**Door Options**

CG.TOP	DPSRR	MFO
	•	•

**OVEN MICROWAVE COMBO CABINET, WARMING DRAWER, 84", 87", 90", 93", or 96" TALL, 24" DEEP**

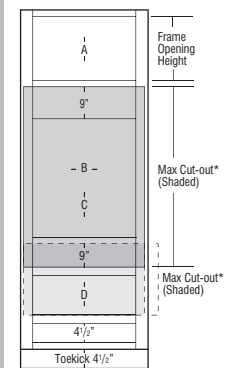
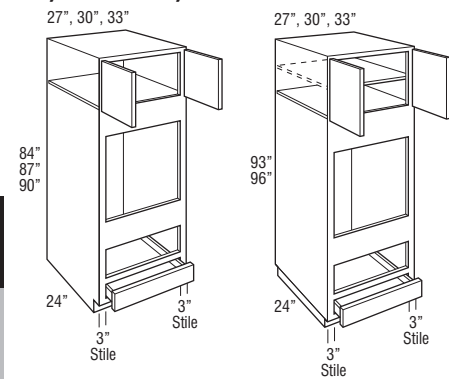

\*Minimum rail height between oven and warming drawer is 1 1/2"

Model	1	2	3	4	5	6
<b>OCS278424WD</b>	1960	2058	2183	2526	2526	2526
<b>OCS308424WD</b>	2059	2174	2270	2765	2892	2914
<b>OCS338424WD</b>	2371	2505	2563	2971	3137	3168
<b>OCS278724WD</b>	2158	2268	2447	2773	2777	2777
<b>OCS308724WD</b>	2269	2394	2559	3004	3141	3171
<b>OCS338724WD</b>	2589	2735	2865	3253	3421	3464
<b>OCS279024WDAH</b>	2355	2478	2713	3022	3028	3028
<b>OCS309024WDAH</b>	2480	2618	2845	3246	3390	3426
<b>OCS339024WDAH</b>	2810	2967	3164	3535	3706	3761
<b>OCS279324WDAH</b>	2751	2899	3245	3483	3527	3527
<b>OCS309324WDAH</b>	2900	3066	3412	3733	3882	3943
<b>OCS339324WDAH</b>	3243	3433	3759	4097	4281	4359
<b>OCS279624WD</b>	2751	2899	3245	3483	3527	3527
<b>OCS309624WD</b>	2900	3066	3412	3733	3882	3943
<b>OCS339624WD</b>	3243	3433	3759	4097	4281	4359

- AH represents upper section alignment with doors on 24" or 27" high cabinets.
- Includes adjustable shelves in upper section:  
90" and 93" tall - one shelf  
96" tall - two shelves
- Full overlay styles feature concealed face mount Smart Stop hinges.
- Cabinets with 3" wide face frames are not available in MDF door styles.
- All top and bottom cross rails are 1 1/2" wide.
- Be sure to confirm a heat shield is built into your appliance by the manufacturer or install the heat shield included with your appliance. Heat shields are sold separately as an accessory.
- Separate pedestal base included but packaged separately on 93" and 96" tall. Pedestal is designed to create a Recessed Left or Right Toe Kick application during field installation, or can be centered. Pedestal must be covered with toeboard material.
- Depth can be reduced to a minimum of 12".
- For built-in appliance support, OCINSTALLKIT is included in 24" deep oven cabinets (see page 582 for details). Oven install kit will not be included when depth is modified.
- OCINSTALLKIT weight limit is 400 lbs. per pair.
- Oven cabinets feature an open back in cut-out area designed to improve field appliance installation.

	A Frame Opening Height	B Cut-out Width		C Cut-out Height		D Warming Drawer Cut-out Height		Door Height (Upper Section)	
		Min.	Max.	Min.	Max.	Min.	Max.	Partial Overlay	Full Overlay
OCS278424WD	15"	21"	25 1/2"	27 3/4"	42 3/4"	9 1/4"	16 3/4"	16"	17 1/2"
OCS308424WD	15"	24"	28 1/2"	27 3/4"	42 3/4"	9 1/4"	16 3/4"	16"	17 1/2"
OCS338424WD	15"	27"	31 1/2"	27 3/4"	42 3/4"	9 1/4"	16 3/4"	16"	17 1/2"
OCS278724WD	18"	21"	25 1/2"	27 3/4"	42 3/4"	9 1/4"	16 3/4"	19"	20 1/2"
OCS308724WD	18"	24"	28 1/2"	27 3/4"	42 3/4"	9 1/4"	16 3/4"	19"	20 1/2"
OCS338724WD	18"	27"	31 1/2"	27 3/4"	42 3/4"	9 1/4"	16 3/4"	19"	20 1/2"
OCS279024WDAH	21"	21"	25 1/2"	27 3/4"	42 3/4"	9 1/4"	16 3/4"	22"	23 1/2"
OCS309024WDAH	21"	24"	28 1/2"	27 3/4"	42 3/4"	9 1/4"	16 3/4"	22"	23 1/2"
OCS339024WDAH	21"	27"	31 1/2"	27 3/4"	42 3/4"	9 1/4"	16 3/4"	22"	23 1/2"
OCS279324WDAH	24"	21"	25 1/2"	27 3/4"	42 3/4"	9 1/4"	16 3/4"	25"	26 1/2"
OCS309324WDAH	24"	24"	28 1/2"	27 3/4"	42 3/4"	9 1/4"	16 3/4"	25"	26 1/2"
OCS339324WDAH	24"	27"	31 1/2"	27 3/4"	42 3/4"	9 1/4"	16 3/4"	25"	26 1/2"
OCS279624WD	27"	21"	25 1/2"	27 3/4"	42 3/4"	9 1/4"	16 3/4"	28"	29 1/2"
OCS309624WD	27"	24"	28 1/2"	27 3/4"	42 3/4"	9 1/4"	16 3/4"	28"	29 1/2"
OCS339624WD	27"	27"	31 1/2"	27 3/4"	42 3/4"	9 1/4"	16 3/4"	28"	29 1/2"

Maximum cut-out dimension will allow 1/4" reveal for doors and drawer fronts on full overlay and 1" for partial overlay for trim kit face clearance.

Model	7	8	9	10	11	12	13	14	15	16	17	18
<b>OCS278424WD</b>	2665	2665	2712	2812	2830	2883	2991	3002	3116	3195	3316	3450
<b>OCS308424WD</b>	3072	3072	3128	3247	3269	3333	3454	3468	3602	3692	3837	3990
<b>OCS338424WD</b>	3342	3342	3402	3528	3557	3624	3757	3775	3922	4021	4178	4343
<b>OCS278724WD</b>	2930	2930	2984	3093	3116	3174	3293	3305	3432	3519	3655	3803
<b>OCS308724WD</b>	3346	3346	3405	3535	3560	3630	3762	3779	3927	4025	4182	4349
<b>OCS338724WD</b>	3655	3655	3723	3863	3894	3967	4116	4133	4294	4408	4577	4763
<b>OCS279024WDAH</b>	3195	3195	3254	3375	3400	3463	3594	3607	3748	3843	3993	4154
<b>OCS309024WDAH</b>	3617	3617	3685	3822	3852	3925	4071	4090	4249	4357	4526	4706
<b>OCS339024WDAH</b>	3971	3971	4044	4198	4230	4311	4473	4491	4669	4794	4979	5180
<b>OCS279324WDAH</b>	3724	3724	3792	3931	3966	4038	4188	4211	4375	4487	4662	4849
<b>OCS309324WDAH</b>	4164	4164	4244	4401	4438	4519	4691	4713	4899	5025	5222	5433
<b>OCS339324WDAH</b>	4604	4604	4694	4871	4910	5005	5196	5216	5426	5565	5786	6019
<b>OCS279624WD</b>	3724	3724	3792	3931	3966	4038	4188	4211	4375	4487	4662	4849
<b>OCS309624WD</b>	4164	4164	4244	4401	4438	4519	4691	4713	4899	5025	5222	5433
<b>OCS339624WD</b>	4604	4604	4694	4871	4910	5005	5196	5216	5426	5565	5786	6019

**Custom Modifications**

ACS	ADDTK	AUTHL AUTHR	CBO	CCO	CFNTO	CFRMO	CND	DRT	DRWTK	EXBKL EXBKR	EXL EXR	FB	FFDL	FPEB	FTK	FTKAV FTKRV	ID	INVERM	MIP	RD	RECTKL RECTKR	RT	TD	TKP	VTK	WLI
									*						*	*								*	*	*

\*Not available on 93" and 96" tall

**Construction Upgrades**

APC	ET	PE

**Door Options**

CG.TOP	DPSRR	MFO



**DOUBLE OVEN CABINET, 84", 87", or 90" TALL, 24" DEEP**

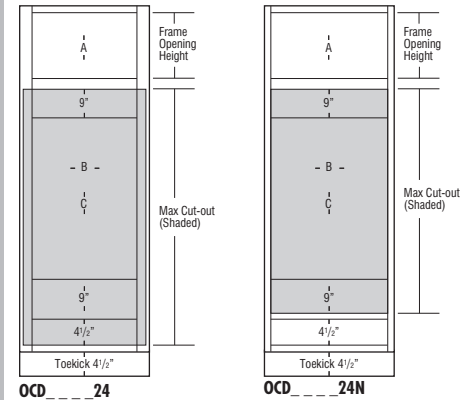
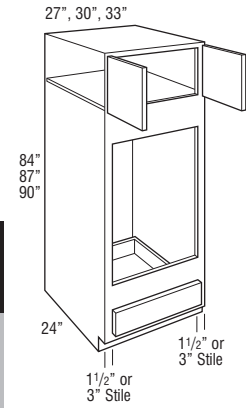

Model	1	2	3	4	5	6
<b>OCD278424(N)</b>	1666	1748	1856	2125	2125	2125
<b>OCD308424(N)</b>	1742	1838	1925	2350	2330	2460
<b>OCD338424(N)</b>	2011	2126	2176	2533	2535	2673
<b>OCD278724(N)</b>	1836	1930	2087	2343	2338	2343
<b>OCD308724(N)</b>	1923	2031	2174	2559	2537	2679
<b>OCD338724(N)</b>	2201	2327	2435	2774	2772	2933
<b>OCD279024(AH or N)</b>	2005	2111	2316	2559	2556	2559
<b>OCD309024(AH or N)</b>	2103	2223	2420	2768	2742	2900
<b>OCD339024(AH or N)</b>	2386	2527	2695	3018	3012	3191

- AH represents upper section alignment with doors on 24" or 27" high cabinets.
- N represents Narrow Stile cabinets with 1 1/2" wide face frame side stiles and ACS modification availability (see page 50 for ACS specifications). Doors and drawer fronts have a consistent width reveal for full overlay (1/4") and partial overlay (1") and use standard Smart Stop hinges.
- On cabinets with 3" wide face frame side stiles, full overlay styles have a consistent 1/4" width frame reveal and use face mounted Smart Stop hinges. Partial overlay styles have a larger 2 1/2" width reveal, use standard Smart Stop hinges, and are not recommended for stacking applications due to misalignment of door width with cabinets above.
- Cabinets with 3" wide face frames are not available in MDF door styles.
- Upper section on 90" tall has one full depth adjustable shelf.
- All top and bottom cross rails are 1 1/2" wide.
- Be sure to confirm a heat shield is built into your appliance by the manufacturer or install the heat shield included with your appliance. Heat shields are sold separately as an accessory.
- Depth can be reduced to a minimum of 12".
- For built-in appliance support, OCINSTALKIT is included in 24" deep oven cabinets (see page 582 for details). Oven install kit will not be included when depth is modified.
- OCINSTALKIT weight limit is 400 lbs. per pair.
- Oven cabinets feature an open back in cut-out area designed to improve field appliance installation.
- Maximum cut-out dimension will allow 1/4" reveal for doors and drawer fronts on full overlay and 1" for partial overlay for trim kit face clearance.

	A Frame Opening Height	B Cut-out Width		C Cut-out Height		Door Height (Upper Section)	
		Min.	Max.	Min.	Max.	Partial Overlay	Full Overlay
OCD278424	15"	21"	25 1/2"	39"	60"	16"	17 1/2"
OCD308424	15"	24"	28 1/2"	39"	60"	16"	17 1/2"
OCD338424	15"	27"	31 1/2"	39"	60"	16"	17 1/2"
OCD278724	18"	21"	25 1/2"	39"	60"	19"	20 1/2"
OCD308724	18"	24"	28 1/2"	39"	60"	19"	20 1/2"
OCD338724	18"	27"	31 1/2"	39"	60"	19"	20 1/2"
OCD279024AH	21"	21"	25 1/2"	39"	60"	22"	23 1/2"
OCD309024AH	21"	24"	28 1/2"	39"	60"	22"	23 1/2"
OCD339024AH	21"	27"	31 1/2"	39"	60"	22"	23 1/2"

	A Frame Opening Height	B Cut-out Width (standard)		B Cut-out Width (with ACS modification)			C Cut-out Height		Door Height (Upper Section)	
		Min.	Max.	Min.	Max.	Max. w/ Field Cut	Min.	Max.	Partial Overlay	Full Overlay
OCD278424N	15"	24"	25 1/2"	21"	24"	25 1/2"	39"	54"	16"	17 1/2"
OCD308424N	15"	27"	28 1/2"	24"	27"	28 1/2"	39"	54"	16"	17 1/2"
OCD338424N	15"	30"	31 1/2"	27"	30"	31 1/2"	39"	54"	16"	17 1/2"
OCD278724N	18"	24"	25 1/2"	21"	24"	25 1/2"	39"	54"	19"	20 1/2"
OCD308724N	18"	27"	28 1/2"	24"	27"	28 1/2"	39"	54"	19"	20 1/2"
OCD338724N	18"	30"	31 1/2"	27"	30"	31 1/2"	39"	54"	19"	20 1/2"
OCD279024N	21"	24"	25 1/2"	21"	24"	25 1/2"	39"	54"	22"	23 1/2"
OCD309024N	21"	27"	28 1/2"	24"	27"	28 1/2"	39"	54"	22"	23 1/2"
OCD339024N	21"	30"	31 1/2"	27"	30"	31 1/2"	39"	54"	22"	23 1/2"

Model	7	8	9	10	11	12	13	14	15	16	17	18
<b>OCD278424(N)</b>	2242	2242	2282	2369	2384	2431	2522	2533	2633	2696	2800	2914
<b>OCD308424(N)</b>	2592	2592	2641	2740	2765	2817	2923	2935	3049	3129	3251	3381
<b>OCD338424(N)</b>	2823	2823	2877	2985	3012	3067	3180	3196	3322	3407	3544	3685
<b>OCD278724(N)</b>	2471	2471	2518	2612	2633	2682	2782	2793	2903	2976	3095	3219
<b>OCD308724(N)</b>	2829	2829	2883	2992	3017	3073	3190	3203	3331	3416	3550	3692
<b>OCD338724(N)</b>	3099	3099	3156	3276	3303	3365	3493	3509	3648	3743	3892	4046
<b>OCD279024(AH or N)</b>	2701	2701	2751	2853	2878	2934	3043	3054	3175	3257	3387	3521
<b>OCD309024(AH or N)</b>	3066	3066	3124	3241	3269	3331	3457	3471	3608	3702	3850	4004
<b>OCD339024(AH or N)</b>	3372	3372	3435	3567	3596	3663	3805	3821	3974	4076	4239	4409

**Custom Modifications**

ACS	ADDTK	AUTHL	AUTHR	CBO	CCO	CFNTD	CFRMO	CND	DRT	DRWTK	EXBKL	EXBKR	EXL	EXR	FB	FFDL	FFDR	FPEB	FTK	FTKAV	FTKRV	ID	INVRM	MIP	RD	RECTKL	RECTKR	RT	TD	TKP	VTK	WLI
•*		•	•	•	•		•	•		•	•	•	•	•		•	•	•	•	•	•	•		•	•	•	•	•	•	•	•	•

\*Only available on Narrow Stile (N) cabinets

**Construction Upgrades**

APC	ET	PE
•		•

**Door Options**

CG.TOP	DPSRR	MFO
	•	•

**DOUBLE OVEN CABINET,  
93" or 96" TALL, 24" DEEP**

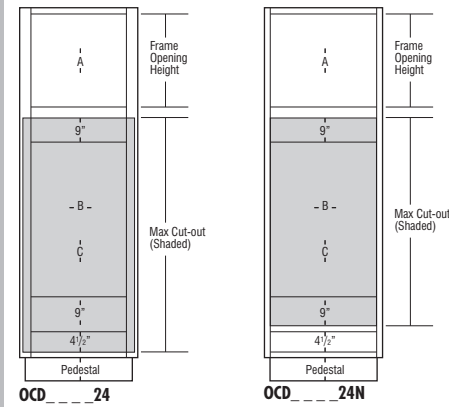
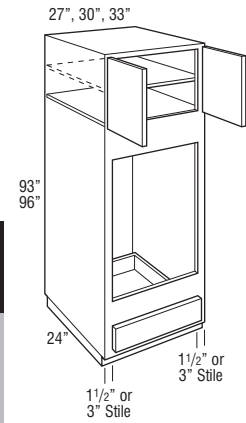

Model	1	2	3	4	5	6
<b>OCD279324(AH or N)</b>	2346	2472	2773	2978	2946	2987
<b>OCD309324(AH or N)</b>	2467	2610	2914	3184	3154	3345
<b>OCD339324(AH or N)</b>	2766	2926	3210	3505	3485	3706

<b>OCD279624(N)</b>	2346	2472	2773	2978	2946	2987
<b>OCD309624(N)</b>	2467	2610	2914	3184	3154	3345
<b>OCD339624(N)</b>	2766	2926	3210	3505	3485	3706

- AH represents upper section alignment with doors on 24" or 27" high cabinets.
- N represents Narrow Stile cabinets with 1 1/2" wide face frame side stiles and ACS modification availability (see page 50 for ACS specifications). Doors and drawer fronts have a consistent width reveal for full overlay (1/4") and partial overlay (1") and use standard Smart Stop hinges.
- On cabinets with 3" wide face frame side stiles, full overlay styles have a consistent 1/4" width frame reveal and use face mounted Smart Stop hinges. Partial overlay styles have a larger 2 1/2" width reveal, use standard Smart Stop hinges, and are not recommended for stacking applications due to misalignment of door width with cabinets above.
- Cabinets with 3" wide face frames are not available in MDF door styles.
- Includes adjustable shelves in upper section:  
93" tall - one shelf  
96" tall - two shelves
- All top and bottom cross rails are 1 1/2" wide.
- Be sure to confirm a heat shield is built into your appliance by the manufacturer or install the heat shield included with your appliance. Heat shields are sold separately as an accessory.
- Separate pedestal base included but packaged separately on 93" and 96" tall. Pedestal is designed to create a Recessed Left or Right Toekick application during field installation, or can be centered. Pedestal must be covered with toeboard material.
- Depth can be reduced to a minimum of 12".
- For built-in appliance support, OCINSTALLKIT is included in 24" deep oven cabinets (see page 582 for details). Oven install kit will not be included when depth is modified.
- OCINSTALLKIT weight limit is 400 lbs. per pair.
- Oven cabinets feature an open back in cut-out area designed to improve field appliance installation.
- Maximum cut-out dimension will allow 1/4" reveal for doors and drawer fronts on full overlay and 1" for partial overlay for trim kit face clearance.

	A Frame Opening Height	B Cut-out Width		C Cut-out Height		Door Height (Upper Section)	
		Min.	Max.	Min.	Max.	Partial Overlay	Full Overlay
OCD279324AH	24"	21"	25 1/2"	39"	60"	25"	26 1/2"
OCD309324AH	24"	24"	28 1/2"	39"	60"	25"	26 1/2"
OCD339324AH	24"	27"	31 1/2"	39"	60"	25"	26 1/2"
OCD279624	27"	21"	25 1/2"	39"	60"	28"	29 1/2"
OCD309624	27"	24"	28 1/2"	39"	60"	28"	29 1/2"
OCD339624	27"	27"	31 1/2"	39"	60"	28"	29 1/2"

	A Frame Opening Height	B Cut-out Width (standard)		B Cut-out Width (with ACS modification)			C Cut-out Height		Door Height (Upper Section)	
		Min.	Max.	Min.	Max.	Max. w/ Field Cut	Min.	Max.	Partial Overlay	Full Overlay
OCD279324N	24"	24"	25 1/2"	21"	24"	25 1/2"	39"	54"	25"	26 1/2"
OCD309324N	24"	27"	28 1/2"	24"	27"	28 1/2"	39"	54"	25"	26 1/2"
OCD339324N	24"	30"	31 1/2"	27"	30"	31 1/2"	39"	54"	25"	26 1/2"
OCD279624N	27"	24"	25 1/2"	21"	24"	25 1/2"	39"	54"	28"	29 1/2"
OCD309624N	27"	27"	28 1/2"	24"	27"	28 1/2"	39"	54"	28"	29 1/2"
OCD339624N	27"	30"	31 1/2"	27"	30"	31 1/2"	39"	54"	28"	29 1/2"

Model	7	8	9	10	11	12	13	14	15	16	17	18
<b>OCD279324(AH or N)</b>	3157	3157	3218	3340	3364	3430	3558	3578	3720	3813	3966	4124
<b>OCD309324(AH or N)</b>	3536	3536	3603	3739	3772	3843	3990	4007	4167	4275	4446	4624
<b>OCD339324(AH or N)</b>	3918	3918	3992	4147	4179	4263	4423	4443	4621	4743	4934	5132

<b>OCD279624(N)</b>	3157	3157	3218	3340	3364	3430	3558	3578	3720	3813	3966	4124
<b>OCD309624(N)</b>	3536	3536	3603	3739	3772	3843	3990	4007	4167	4275	4446	4624
<b>OCD339624(N)</b>	3918	3918	3992	4147	4179	4263	4423	4443	4621	4743	4934	5132

**Custom Modifications**

ACS	ADDTK	AUTHL AUTHR	CBO	CCO	CFNTO	CFRMO	CND	DRT	DRWTK	EXBKL EXBKR	EXL EXR	FB	FFDL FFDR	FPEB	FTK	FTKAV FTKRV	ID	INVFRM	MIP	RD	RECTKL RECTKR	RT	TD	TKP	VTK	WLI
•*		•	•	•		•	•			•	•	•		•			•		•	•	•		•			•

\*Only available on Narrow Stile (N) cabinets

**Construction Upgrades**

APC	ET	PE
•		•

**Door Options**

CG.TOP	DPSRR	MFO
	•	•

**DOUBLE OVEN CABINET, DEEP DRAWER, 84", 87", or 90" TALL, 24" DEEP**

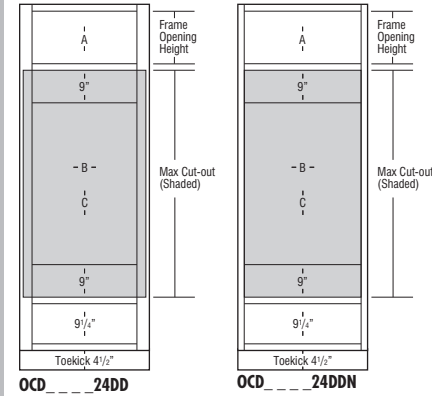
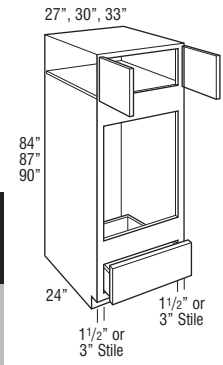

OCD 24DD

OCD 24DDN

Model	1	2	3	4	5	6
OCD278424DD(N)	1908	1998	2118	2473	2453	2521
OCD308424DD(N)	2077	2185	2279	2744	2724	2972
OCD338424DD(N)	2489	2615	2670	3064	3066	3326
OCD278724DD(N)	2093	2199	2369	2694	2669	2761
OCD308724DD(N)	2275	2395	2550	2975	2950	3219
OCD338724DD(N)	2697	2838	2957	3332	3326	3611
OCD279024DD(N)	2279	2396	2622	2914	2884	2999
OCD309024DD(N)	2474	2608	2822	3205	3176	3463
OCD339024DD(N)	2905	3057	3241	3597	3587	3897

- N represents Narrow Stile cabinets with 1 1/2" wide face frame side stiles and ACS modification availability (see page 50 for ACS specifications). Doors and drawer fronts have a consistent width reveal for full overlay (1/4") and partial overlay (1") and use standard Smart Stop hinges.
- On cabinets with 3" wide face frame side stiles, full overlay styles have a consistent 1/4" width frame reveal and use face mounted Smart Stop hinges. Partial overlay styles have a larger 2 1/2" width reveal, use standard Smart Stop hinges, and are not recommended for stacking applications due to misalignment of door width with cabinets above.
- All top and bottom cross rails are 1 1/2" wide.
- Be sure to confirm a heat shield is built into your appliance by the manufacturer or install the heat shield included with your appliance. Heat shields are sold separately as an accessory.
- Depth can be reduced to a minimum of 12".
- For built-in appliance support, OCINSTALLKIT is included in 24" deep oven cabinets (see page 582 for details). Oven install kit will not be included when depth is modified.
- OCINSTALLKIT weight limit is 400 lbs. per pair.
- Oven cabinets feature an open back in cut-out area designed to improve field appliance installation.
- Maximum cut-out dimension will allow 1/4" reveal for doors and drawer fronts on full overlay and 1" for partial overlay for trim kit face clearance.

	A Frame Opening Height	B Cut-out Width		C Cut-out Height		Door Height (Upper Section)	
		Min.	Max.	Min.	Max.	Partial Overlay	Full Overlay
OCD278424DD	12"	21"	25 1/2"	37 1/4"	52 1/4"	13"	14 1/2"
OCD308424DD	12"	24"	28 1/2"	37 1/4"	52 1/4"	13"	14 1/2"
OCD338424DD	12"	27"	31 1/2"	37 1/4"	52 1/4"	13"	14 1/2"
OCD278724DD	15"	21"	25 1/2"	37 1/4"	52 1/4"	16"	17 1/2"
OCD308724DD	15"	24"	28 1/2"	37 1/4"	52 1/4"	16"	17 1/2"
OCD338724DD	15"	27"	31 1/2"	37 1/4"	52 1/4"	16"	17 1/2"
OCD279024DD	18"	21"	25 1/2"	37 1/4"	52 1/4"	19"	20 1/2"
OCD309024DD	18"	24"	28 1/2"	37 1/4"	52 1/4"	19"	20 1/2"
OCD339024DD	18"	27"	31 1/2"	37 1/4"	52 1/4"	19"	20 1/2"

	A Frame Opening Height	B Cut-out Width (standard)		B Cut-out Width (with ACS modification)			C Cut-out Height		Door Height (Upper Section)	
		Min.	Max.	Min.	Max.	Max. w/ Field Cut	Min.	Max.	Partial Overlay	Full Overlay
OCD278424DDN	12"	24"	25 1/2"	21"	24"	25 1/2"	37 1/4"	52 1/4"	13"	14 1/2"
OCD308424DDN	12"	27"	28 1/2"	24"	27"	28 1/2"	37 1/4"	52 1/4"	13"	14 1/2"
OCD338424DDN	12"	30"	31 1/2"	27"	30"	31 1/2"	37 1/4"	52 1/4"	13"	14 1/2"
OCD278724DDN	15"	24"	25 1/2"	21"	24"	25 1/2"	37 1/4"	52 1/4"	16"	17 1/2"
OCD308724DDN	15"	27"	28 1/2"	24"	27"	28 1/2"	37 1/4"	52 1/4"	16"	17 1/2"
OCD338724DDN	15"	30"	31 1/2"	27"	30"	31 1/2"	37 1/4"	52 1/4"	16"	17 1/2"
OCD279024DDN	18"	24"	25 1/2"	21"	24"	25 1/2"	37 1/4"	52 1/4"	19"	20 1/2"
OCD309024DDN	18"	27"	28 1/2"	24"	27"	28 1/2"	37 1/4"	52 1/4"	19"	20 1/2"
OCD339024DDN	18"	30"	31 1/2"	27"	30"	31 1/2"	37 1/4"	52 1/4"	19"	20 1/2"

Model	7	8	9	10	11	12	13	14	15	16	17	18
OCD278424DD(N)	2651	2651	2695	2790	2810	2859	2960	2971	3078	3153	3269	3387
OCD308424DD(N)	3122	3122	3175	3290	3311	3368	3485	3500	3627	3713	3848	3986
OCD338424DD(N)	3491	3491	3551	3670	3698	3759	3886	3904	4044	4137	4284	4438
OCD278724DD(N)	2904	2904	2955	3057	3079	3134	3246	3259	3377	3461	3589	3723
OCD308724DD(N)	3382	3382	3443	3563	3588	3652	3779	3794	3934	4030	4178	4330
OCD338724DD(N)	3793	3793	3859	3990	4022	4089	4229	4247	4401	4505	4669	4835
OCD279024DD(N)	3157	3157	3213	3323	3351	3410	3531	3546	3678	3767	3909	4055
OCD309024DD(N)	3641	3641	3709	3837	3866	3933	4072	4090	4241	4343	4507	4672
OCD339024DD(N)	4095	4095	4166	4312	4343	4417	4570	4592	4758	4872	5052	5233

**Custom Modifications**

ACS	ADDTK	AUTHL	AUTHR	CBO	CCO	CFNTO	CFRMO	CND	DRT	DRWTK	EXBKL	EXBKR	EXL	EXR	FB	FFDL	FFDR	FPEB	FTK	FTKAV	FTKRV	ID	INVFRM	MIP	RD	RECTKL	RECTKR	RT	TD	TKP	VTK	WLI	
•*										•	•	•	•	•																			

\*Only available on Narrow Stile (N) cabinets    \*Not available on 87" tall    \*Not available on 84" tall

**Construction Upgrades**

APC	ET	PE
•		•

**Door Options**

CG.TOP	DPSRR	MFO
	•	•

**DOUBLE OVEN CABINET, DEEP DRAWER, 93" or 96" TALL, 24" DEEP**

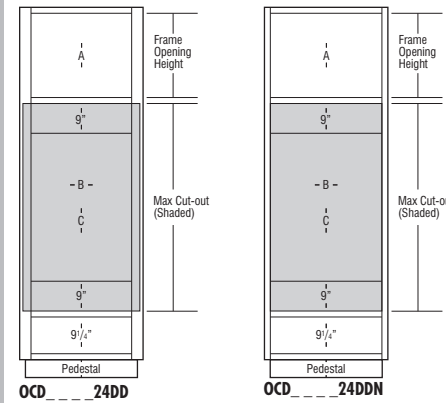
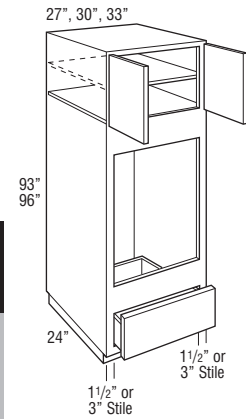

Model	1	2	3	4	5	6
OCD279324DD(AH or N)	2654	2794	3125	3351	3316	3470
OCD309324DD(AH or N)	2874	3030	3366	3665	3633	3949
OCD339324DD(AH or N)	3318	3496	3808	4132	4110	4465

OCD279624DD(AH or N)	2654	2794	3125	3351	3316	3470
OCD309624DD(AH or N)	2874	3030	3366	3665	3633	3949
OCD339624DD(AH or N)	3232	3410	3724	4046	4026	4381

- AH represents upper section alignment with doors on 24" or 27" high cabinets.
- N represents Narrow Stile cabinets with 1 1/2" wide face frame side stiles and ACS modification availability (see page 50 for ACS specifications). Doors and drawer fronts have a consistent width reveal for full overlay (1/4") and partial overlay (1") and use standard Smart Stop hinges.
- On cabinets with 3" wide face frame side stiles, full overlay styles have a consistent 1/4" width frame reveal and use face mounted Smart Stop hinges. Partial overlay styles have a larger 2 1/2" width reveal, use standard Smart Stop hinges, and are not recommended for stacking applications due to misalignment of door width with cabinets above.
- All top and bottom cross rails are 1 1/2" wide.
- Be sure to confirm a heat shield is built into your appliance by the manufacturer or install the heat shield included with your appliance. Heat shields are sold separately as an accessory.
- Separate pedestal base included but packaged separately on 93" and 96" tall. Pedestal is designed to create a Recessed Left or Right ToeKick application during field installation, or can be centered. Pedestal must be covered with toeboard material.
- One full depth adjustable shelf included, but packaged separately.
- Depth can be reduced to a minimum of 12".
- For built-in appliance support, OCINSTALKIT is included in 24" deep oven cabinets (see page 582 for details). Oven install kit will not be included when depth is modified.
- OCINSTALKIT weight limit is 400 lbs. per pair.
- Oven cabinets feature an open back in cut-out area designed to improve field appliance installation.
- Maximum cut-out dimension will allow 1/4" reveal for doors and drawer fronts on full overlay and 1" for partial overlay for trim kit face clearance.

	A Frame Opening Height	B Cut-out Width		C Cut-out Height		Door Height (Upper Section)	
		Min.	Max.	Min.	Max.	Partial Overlay	Full Overlay
OCD279324DDAH	21"	21"	25 1/2"	37 1/4"	52 1/4"	22"	23 1/2"
OCD309324DDAH	21"	24"	28 1/2"	37 1/4"	52 1/4"	22"	23 1/2"
OCD339324DDAH	21"	27"	31 1/2"	37 1/4"	52 1/4"	22"	23 1/2"
OCD279624DDAH	24"	21"	25 1/2"	37 1/4"	52 1/4"	25"	26 1/2"
OCD309624DDAH	24"	24"	28 1/2"	37 1/4"	52 1/4"	25"	26 1/2"
OCD339624DDAH	24"	27"	31 1/2"	37 1/4"	52 1/4"	25"	26 1/2"

	A Frame Opening Height	B Cut-out Width (standard)		B Cut-out Width (with ACS modification)			C Cut-out Height		Door Height (Upper Section)	
		Min.	Max.	Min.	Max.	Max. w/ Field Cut	Min.	Max.	Partial Overlay	Full Overlay
OCD279324DDN	21"	24"	25 1/2"	21"	24"	25 1/2"	37 1/4"	52 1/4"	22"	23 1/2"
OCD309324DDN	21"	27"	28 1/2"	24"	27"	28 1/2"	37 1/4"	52 1/4"	22"	23 1/2"
OCD339324DDN	21"	30"	31 1/2"	27"	30"	31 1/2"	37 1/4"	52 1/4"	22"	23 1/2"
OCD279624DDN	24"	24"	25 1/2"	21"	24"	25 1/2"	37 1/4"	52 1/4"	25"	26 1/2"
OCD309624DDN	24"	27"	28 1/2"	24"	27"	28 1/2"	37 1/4"	52 1/4"	25"	26 1/2"
OCD339624DDN	24"	30"	31 1/2"	27"	30"	31 1/2"	37 1/4"	52 1/4"	25"	26 1/2"

Model	7	8	9	10	11	12	13	14	15	16	17	18
OCD279324DD(AH or N)	3657	3657	3722	3857	3887	3956	4100	4118	4275	4380	4549	4719
OCD309324DD(AH or N)	4161	4161	4235	4385	4420	4501	4661	4680	4855	4975	5163	5356
OCD339324DD(AH or N)	4698	4698	4778	4951	4982	5073	5255	5274	5473	5606	5816	6027

OCD279624DD(AH or N)	3657	3657	3722	3857	3887	3956	4100	4118	4275	4380	4549	4719
OCD309624DD(AH or N)	4161	4161	4235	4385	4420	4501	4661	4680	4855	4975	5163	5356
OCD339624DD(AH or N)	4613	4613	4694	4865	4899	4990	5168	5189	5386	5521	5816	6027

**Custom Modifications**

ACS	ADDTK	AUTHL AUTHR	CBO	CCO	CFNTO	CFRMO	CND	DRT	DRWTK	EXBKL EXBKR	EXL EXR	FB	FFDL	FFDR	FPEB	FTK	FTKAV FTKFV	ID	INVFRM	MIP	RD	RECTKL RECTKR	RT	TD	TKP	VTK	WLI
•*		•	•	•		•	•			•	•	•			•			•		•	•	•		•			•

\*Only available on Narrow Stile (N) cabinets

**Construction Upgrades**

APC	ET	PE
•		•

**Door Options**

CG.TOP	DPSRR	MFO
	•	•

**DOUBLE OVEN CABINET, WARMING DRAWER, 84", 87", 90", 93", or 96" TALL, 24" DEEP**

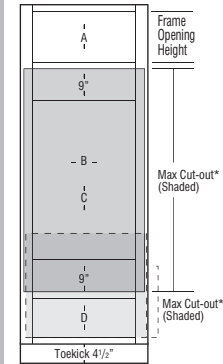
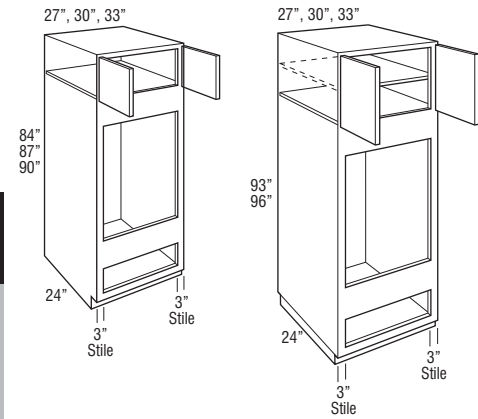

\*Minimum rail height between oven and warming drawer is 1 1/2"

Model	1	2	3	4	5	6
<b>OCD278424WD</b>	1619	1708	1829	2184	2163	2232
<b>OCD308424WD</b>	1700	1808	1903	2369	2349	2596
<b>OCD338424WD</b>	1999	2125	2179	2571	2576	2836

<b>OCD278724WD</b>	1804	1909	2081	2405	2380	2471
<b>OCD308724WD</b>	1899	2021	2176	2599	2576	2842
<b>OCD338724WD</b>	2206	2346	2466	2839	2836	3121

<b>OCD279024WD</b>	1990	2108	2333	2624	2594	2710
<b>OCD309024WD</b>	2098	2232	2445	2829	2800	3088
<b>OCD339024WD</b>	2415	2565	2751	3105	3096	3405

<b>OCD279324WDAH</b>	2364	2506	2837	3062	3026	3180
<b>OCD309324WDAH</b>	2497	2656	2991	3291	3256	3574
<b>OCD339324WDAH</b>	2740	2919	3231	3554	3534	3888

<b>OCD279624WDAH</b>	2364	2506	2837	3062	3026	3180
<b>OCD309624WDAH</b>	2497	2656	2991	3291	3256	3574
<b>OCD339624WDAH</b>	2740	2919	3231	3554	3534	3888

- AH represents upper section alignment with doors on 24" or 27" high cabinets.
- Includes one adjustable shelf in upper section of 93" and 96" tall.
- Full overlay styles feature concealed face mount Smart Stop hinges.
- All top and bottom cross rails are 1 1/2" wide.
- Be sure to confirm a heat shield is built into your appliance by the manufacturer or install the heat shield included with your appliance. Heat shields are sold separately as an accessory.
- Separate pedestal base included but packaged separately on 93" and 96" tall. Pedestal is designed to create a Recessed Left or Right Toekick application during field installation, or can be centered. Pedestal must be covered with toeboard material.
- Depth can be reduced to a minimum of 6". For depths of 6"-8", cabinet will not include toekick/pedestal.
- For built-in appliance support, OCINSTALLKIT is included in 24" deep oven cabinets (see page 582 for details). Oven install kit will not be included when depth is modified.
- OCINSTALLKIT weight limit is 400 lbs. per pair.
- Oven cabinets feature an open back in cut-out area designed to improve field appliance installation.

	A		B		C		D		Door Height (Upper Section)	
	Frame Opening Height	Cut-out Width		Cut-out Height		Warming Drawer Cut-out Height		Partial Overlay	Full Overlay	
OCD278424WD	12"	21"	25 1/2"	37 1/4"	52 1/4"	9 1/4"	16 3/4"	13"	14 1/2"	
OCD308424WD	12"	24"	28 1/2"	37 1/4"	52 1/4"	9 1/4"	16 3/4"	13"	14 1/2"	
OCD338424WD	12"	27"	31 1/2"	37 1/4"	52 1/4"	9 1/4"	16 3/4"	13"	14 1/2"	
OCD278724WD	15"	21"	25 1/2"	37 1/4"	52 1/4"	9 1/4"	16 3/4"	16"	17 1/2"	
OCD308724WD	15"	24"	28 1/2"	37 1/4"	52 1/4"	9 1/4"	16 3/4"	16"	17 1/2"	
OCD338724WD	15"	27"	31 1/2"	37 1/4"	52 1/4"	9 1/4"	16 3/4"	16"	17 1/2"	
OCD279024WD	18"	21"	25 1/2"	37 1/4"	52 1/4"	9 1/4"	16 3/4"	19"	20 1/2"	
OCD309024WD	18"	24"	28 1/2"	37 1/4"	52 1/4"	9 1/4"	16 3/4"	19"	20 1/2"	
OCD339024WD	18"	27"	31 1/2"	37 1/4"	52 1/4"	9 1/4"	16 3/4"	19"	20 1/2"	
OCD279324WDAH	21"	21"	25 1/2"	37 1/4"	52 1/4"	9 1/4"	16 3/4"	22"	23 1/2"	
OCD309324WDAH	21"	24"	28 1/2"	37 1/4"	52 1/4"	9 1/4"	16 3/4"	22"	23 1/2"	
OCD339324WDAH	21"	27"	31 1/2"	37 1/4"	52 1/4"	9 1/4"	16 3/4"	22"	23 1/2"	
OCD279624WDAH	24"	21"	25 1/2"	37 1/4"	52 1/4"	9 1/4"	16 3/4"	25"	26 1/2"	
OCD309624WDAH	24"	24"	28 1/2"	37 1/4"	52 1/4"	9 1/4"	16 3/4"	25"	26 1/2"	
OCD339624WDAH	24"	27"	31 1/2"	37 1/4"	52 1/4"	9 1/4"	16 3/4"	25"	26 1/2"	

Maximum cut-out dimension will allow 1/4" reveal for doors and drawer fronts on full overlay and 1" for partial overlay for trim kit face clearance.

Model	7	8	9	10	11	12	13	14	15	16	17	18
<b>OCD278424WD</b>	2362	2362	2408	2501	2520	2569	2670	2682	2789	2865	2979	3099
<b>OCD308424WD</b>	2745	2745	2799	2913	2936	2994	3110	3123	3250	3338	3471	3609
<b>OCD338424WD</b>	3000	3000	3060	3178	3206	3268	3395	3412	3552	3645	3793	3945

<b>OCD278724WD</b>	2615	2615	2666	2768	2790	2846	2956	2970	3089	3172	3300	3433
<b>OCD308724WD</b>	3006	3006	3066	3188	3213	3276	3403	3419	3558	3653	3802	3953
<b>OCD338724WD</b>	3302	3302	3367	3500	3530	3597	3738	3757	3909	4013	4177	4343

<b>OCD279024WD</b>	2869	2869	2924	3035	3062	3122	3243	3256	3390	3479	3623	3766
<b>OCD309024WD</b>	3265	3265	3334	3461	3489	3557	3697	3713	3866	3968	4130	4295
<b>OCD339024WD</b>	3603	3603	3675	3819	3852	3926	4079	4101	4267	4382	4561	4742

<b>OCD279324WDAH</b>	3368	3368	3432	3568	3598	3666	3810	3829	3986	4090	4260	4429
<b>OCD309324WDAH</b>	3784	3784	3859	4008	4044	4124	4284	4305	4478	4600	4788	4979
<b>OCD339324WDAH</b>	4120	4120	4203	4373	4408	4498	4677	4698	4979	5113	5323	5536

<b>OCD279624WDAH</b>	3368	3368	3432	3568	3598	3666	3810	3829	3986	4090	4260	4429
<b>OCD309624WDAH</b>	3784	3784	3859	4008	4044	4124	4284	4305	4478	4600	4788	4979
<b>OCD339624WDAH</b>	4120	4120	4203	4373	4408	4498	4677	4698	4895	5029	5323	5536

**Custom Modifications**

ACS	ADDTK	AUTHL	AUTHR	CBO	CCO	CFNTO	CFRMO	CND	DRT	DRWTK	EXBKL	EXBKR	EXL	EXR	FB	FFDL	FFDR	FPEB	FTK	FTKAV	FTKRV	ID	INVFRM	MIP	RD	RECTKL	RECTKR	RT	TD	TKP	VTK	WLI	

\*Not available on 84", 87", and 90" tall \*Not available on 93" and 96" tall \*Not available on 84" tall

**Construction Upgrades**

APC	ET	PE

**Door Options**

CG.TOP	DPSRR	MFO

**DOUBLE OVEN CABINET, WARMING DRAWER with EXTENDED OPENING, 84", 87", 90", 93", or 96" TALL, 24" DEEP**

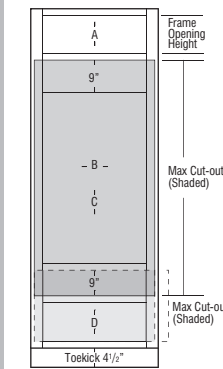
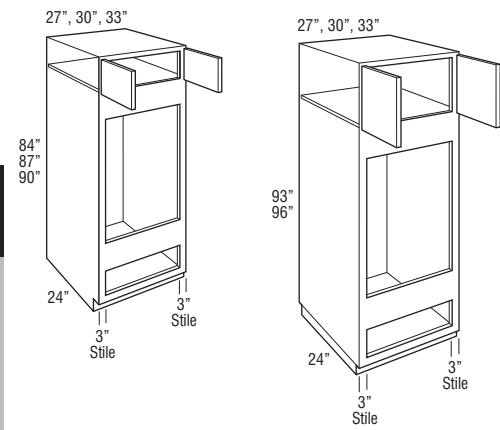

\*Minimum rail height between oven and warming drawer is 1 1/2"

Model	1	2	3	4	5	6
<b>OCD278424WDE</b>	1586	1674	1793	2140	2121	2187
<b>OCD308424WDE</b>	1666	1772	1865	2321	2302	2544
<b>OCD338424WDE</b>	1958	2082	2135	2520	2524	2778
<b>OCD278724WDE</b>	1768	1871	2039	2357	2332	2422
<b>OCD308724WDE</b>	1860	1980	2132	2547	2524	2786
<b>OCD338724WDE</b>	2162	2300	2417	2782	2778	3058
<b>OCD279024WDE</b>	1951	2065	2286	2571	2542	2655
<b>OCD309024WDE</b>	2056	2187	2396	2772	2744	3024
<b>OCD339024WDE</b>	2367	2514	2695	3044	3032	3338
<b>OCD279324WDE</b>	2317	2456	2780	3001	2967	3117
<b>OCD309324WDE</b>	2446	2603	2930	3224	3191	3503
<b>OCD339324WDE</b>	2686	2861	3168	3483	3463	3810
<b>OCD279624WDEAH</b>	2317	2456	2780	3001	2967	3117
<b>OCD309624WDEAH</b>	2446	2603	2930	3224	3191	3503
<b>OCD339624WDEAH</b>	2686	2861	3168	3483	3463	3810

- AH represents upper section alignment with doors on 24" or 27" high cabinets.
- Includes one adjustable shelf in upper section of 93" and 96" tall.
- Full overlay styles feature concealed face mount Smart Stop hinges.
- All top and bottom cross rails are 1 1/2" wide.
- Standard interior (matching interior not required).
- Be sure to confirm a heat shield is built into your appliance by the manufacturer or install the heat shield included with your appliance. Heat shields are sold separately as an accessory.
- Separate pedestal base included but packaged separately on 93" and 96" tall. Pedestal is designed to create a Recessed Left or Right Toekick application during field installation, or can be centered. Pedestal must be covered with toeboard material.
- Depth can be reduced to a minimum of 6". For depths of 6"-8", cabinet will not include toekick/pedestal.
- For built-in appliance support, OCINSTALLKIT is included in 24" deep oven cabinets (see page 582 for details). Oven install kit will not be included when depth is modified.
- OCINSTALLKIT weight limit is 400 lbs. per pair.
- Oven cabinets feature an open back in cut-out area designed to improve field appliance installation.

	A Frame Opening Height	B Cut-out Width		C Cut-out Height		D Warming Drawer Cut-out Height		Door Height (Upper Section)	
		Min.	Max.	Min.	Max.	Min.	Max.	Partial Overlay	Full Overlay
OCD278424WDE	9"	21"	25 1/2"	40 1/4"	55 1/4"	9 1/4"	16 3/4"	10"	11 1/2"
OCD308424WDE	9"	24"	28 1/2"	40 1/4"	55 1/4"	9 1/4"	16 3/4"	10"	11 1/2"
OCD338424WDE	9"	27"	31 1/2"	40 1/4"	55 1/4"	9 1/4"	16 3/4"	10"	11 1/2"
OCD278724WDE	12"	21"	25 1/2"	40 1/4"	55 1/4"	9 1/4"	16 3/4"	13"	14 1/2"
OCD308724WDE	12"	24"	28 1/2"	40 1/4"	55 1/4"	9 1/4"	16 3/4"	13"	14 1/2"
OCD338724WDE	12"	27"	31 1/2"	40 1/4"	55 1/4"	9 1/4"	16 3/4"	13"	14 1/2"
OCD279024WDE	15"	21"	25 1/2"	40 1/4"	55 1/4"	9 1/4"	16 3/4"	16"	17 1/2"
OCD309024WDE	15"	24"	28 1/2"	40 1/4"	55 1/4"	9 1/4"	16 3/4"	16"	17 1/2"
OCD339024WDE	15"	27"	31 1/2"	40 1/4"	55 1/4"	9 1/4"	16 3/4"	16"	17 1/2"
OCD279324WDE	18"	21"	25 1/2"	40 1/4"	55 1/4"	9 1/4"	16 3/4"	19"	20 1/2"
OCD309324WDE	18"	24"	28 1/2"	40 1/4"	55 1/4"	9 1/4"	16 3/4"	19"	20 1/2"
OCD339324WDE	18"	27"	31 1/2"	40 1/4"	55 1/4"	9 1/4"	16 3/4"	19"	20 1/2"
OCD279624WDEAH	21"	21"	25 1/2"	40 1/4"	55 1/4"	9 1/4"	16 3/4"	22"	23 1/2"
OCD309624WDEAH	21"	24"	28 1/2"	40 1/4"	55 1/4"	9 1/4"	16 3/4"	22"	23 1/2"
OCD339624WDEAH	21"	27"	31 1/2"	40 1/4"	55 1/4"	9 1/4"	16 3/4"	22"	23 1/2"

Maximum cut-out dimension will allow 1/4" reveal for doors and drawer fronts on full overlay and 1" for partial overlay for trim kit face clearance.

Model	7	8	9	10	11	12	13	14	15	16	17	18
<b>OCD278424WDE</b>	2315	2315	2359	2451	2470	2518	2617	2629	2733	2809	2920	3037
<b>OCD308424WDE</b>	2690	2690	2743	2854	2877	2933	3048	3061	3183	3271	3401	3538
<b>OCD338424WDE</b>	2939	2939	2999	3115	3142	3203	3326	3344	3481	3571	3717	3867
<b>OCD278724WDE</b>	2563	2563	2612	2713	2734	2789	2897	2912	3025	3108	3234	3364
<b>OCD308724WDE</b>	2946	2946	3005	3124	3148	3212	3336	3350	3487	3581	3726	3876
<b>OCD338724WDE</b>	3236	3236	3300	3430	3459	3524	3664	3682	3832	3932	4092	4257
<b>OCD279024WDE</b>	2811	2811	2865	2973	3001	3060	3178	3191	3321	3408	3550	3691
<b>OCD309024WDE</b>	3199	3199	3267	3393	3420	3486	3624	3639	3789	3888	4046	4210
<b>OCD339024WDE</b>	3531	3531	3601	3742	3775	3847	3996	4019	4182	4294	4469	4647
<b>OCD279324WDE</b>	3301	3301	3362	3498	3526	3594	3734	3753	3906	4008	4174	4341
<b>OCD309324WDE</b>	3709	3709	3782	3929	3964	4041	4198	4218	4389	4509	4693	4880
<b>OCD339324WDE</b>	4038	4038	4119	4286	4319	4409	4584	4604	4880	5011	5216	5427
<b>OCD279624WDEAH</b>	3301	3301	3362	3498	3526	3594	3734	3753	3906	4008	4174	4341
<b>OCD309624WDEAH</b>	3709	3709	3782	3929	3964	4041	4198	4218	4389	4509	4693	4880
<b>OCD339624WDEAH</b>	4038	4038	4119	4286	4319	4409	4584	4604	4797	4929	5216	5427

**Custom Modifications**

ACS	ADDTK	AUTHL	AUTHR	CBO	CCO	CFNTO	CFRMO	CND	DRT	DRWTK	EXBKL	EXBKR	EXL	EXR	FB	FFDL	FFDR	FPEB	FTK	FTKAV	FTKRV	ID	INVRM	MIP	RD	RECTKL	RECTKR	RT	TD	TKP	VTK	WLI	

\*Not available on 93" and 96" tall    \*Not available on 96" tall    \*Not available on 84", 87", 90", and 93" tall

**Construction Upgrades**

APC	ET	PE

**Door Options**

CG.TOP	DPSRR	MFO

**TALL BUILT-IN MICROWAVE CABINET, 84", 87", 90", 93", or 96" TALL**

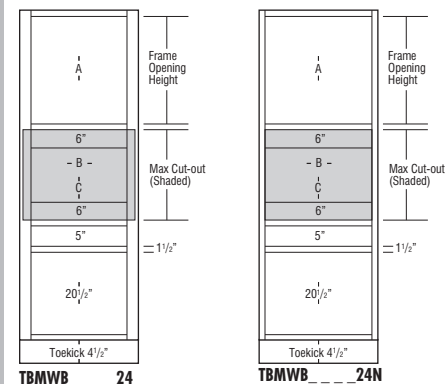
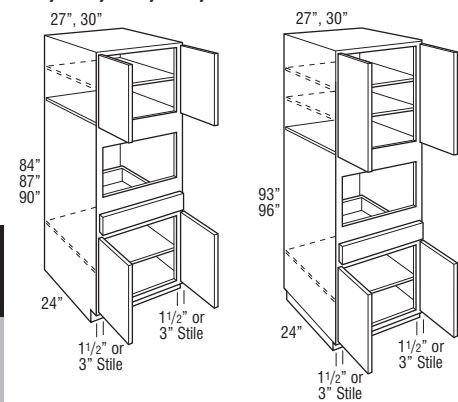

Model	1	2	3	4	5	6
<b>TBMWB278424(AH or N)</b>	1903	2001	2121	2444	2444	2444
<b>TBMWB308424(AH or N)</b>	2002	2114	2214	2709	2683	2833
<b>TBMWB278724(N)</b>	2099	2211	2390	2696	2690	2696
<b>TBMWB308724(N)</b>	2213	2338	2500	2948	2924	3092
<b>TBMWB279024(N)</b>	2297	2422	2655	2948	2935	2948
<b>TBMWB309024(N)</b>	2424	2560	2786	3188	3163	3347
<b>TBMWB279324(N)</b>	2692	2840	3187	3427	3387	3445
<b>TBMWB309324(N)</b>	2841	3007	3354	3676	3637	3863
<b>TBMWB279624(N)</b>	2692	2840	3187	3427	3387	3445
<b>TBMWB309624(N)</b>	2841	3007	3354	3676	3637	3863

- AH represents upper section alignment with doors on 24" or 27" high cabinets.
- N represents Narrow Stile cabinets with 1 1/2" wide face frame side stiles and ACS modification availability (see page 50 for ACS specifications). Doors and drawer fronts have a consistent width reveal for full overlay (1/4") and partial overlay (1") and use standard Smart Stop hinges.
- On cabinets with 3" wide face frame side stiles, doors and drawer fronts have a consistent width reveal for full overlay (1/4") and partial overlay (1") and use face mount Smart Stop hinges. When CG is specified, face frame will be visible through door if used with a translucent art or textured glass design.
- Cabinets with 3" wide face frames are not available in MDF door styles.
- Includes adjustable shelves in upper section:  
84" tall - one shelf  
87"-93" tall - two shelves  
96" tall - three shelves
- Base section will utilize a full depth shelf.
- All top and bottom cross rails are 1 1/2" wide.
- All toekick areas are 4 1/2" high.
- Separate pedestal base included but packaged separately on 93" and 96" tall. Pedestal is designed to create a Recessed Left or Right Toekick application during field installation, or can be centered. Pedestal must be covered with toeboard material.
- Includes OCINSTALLKIT for microwave installation.
- OCINSTALLKIT weight limit is 400 lbs. per pair.
- Maximum cut-out dimension will allow 1/4" reveal for doors and drawer fronts on full overlay and 1" for partial overlay for trim kit face clearance.

	A Frame Opening Height	B Cut-out Width		C Cut-out Height		Door Height (Upper Section)	
		Min.	Max.	Min.	Max.	Partial Overlay	Full Overlay
TBMWB278424AH	24"	21"	25 1/2"	13 1/2"	22 1/2"	25"	26 1/2"
TBMWB308424AH	24"	24"	28 1/2"	13 1/2"	22 1/2"	25"	26 1/2"
TBMWB278724	27"	21"	25 1/2"	13 1/2"	22 1/2"	28"	29 1/2"
TBMWB308724	27"	24"	28 1/2"	13 1/2"	22 1/2"	28"	29 1/2"
TBMWB279024	30"	21"	25 1/2"	13 1/2"	22 1/2"	31"	32 1/2"
TBMWB309024	30"	24"	28 1/2"	13 1/2"	22 1/2"	31"	32 1/2"
TBMWB279324	33"	21"	25 1/2"	13 1/2"	22 1/2"	34"	35 1/2"
TBMWB309324	33"	24"	28 1/2"	13 1/2"	22 1/2"	34"	35 1/2"
TBMWB279624	36"	21"	25 1/2"	13 1/2"	22 1/2"	37"	38 1/2"
TBMWB309624	36"	24"	28 1/2"	13 1/2"	22 1/2"	37"	38 1/2"

	A Frame Opening Height	B Cut-out Width (standard)		B Cut-out Width (with ACS modification)			C Cut-out Height		Door Height (Upper Section)	
		Min.	Max.	Min.	Max.	Max. w/ Field Cut	Min.	Max.	Partial Overlay	Full Overlay
TBMWB278424N	24"	24"	25 1/2"	21"	24"	25 1/2"	13 1/2"	22 1/2"	25"	26 1/2"
TBMWB308424N	24"	27"	28 1/2"	24"	27"	28 1/2"	13 1/2"	22 1/2"	25"	26 1/2"
TBMWB278724N	27"	24"	25 1/2"	21"	24"	25 1/2"	13 1/2"	22 1/2"	28"	29 1/2"
TBMWB308724N	27"	27"	28 1/2"	24"	27"	28 1/2"	13 1/2"	22 1/2"	28"	29 1/2"
TBMWB279024N	30"	24"	25 1/2"	21"	24"	25 1/2"	13 1/2"	22 1/2"	31"	32 1/2"
TBMWB309024N	30"	27"	28 1/2"	24"	27"	28 1/2"	13 1/2"	22 1/2"	31"	32 1/2"
TBMWB279324N	33"	24"	25 1/2"	21"	24"	25 1/2"	13 1/2"	22 1/2"	34"	35 1/2"
TBMWB309324N	33"	27"	28 1/2"	24"	27"	28 1/2"	13 1/2"	22 1/2"	34"	35 1/2"
TBMWB279624N	36"	24"	25 1/2"	21"	24"	25 1/2"	13 1/2"	22 1/2"	37"	38 1/2"
TBMWB309624N	36"	27"	28 1/2"	24"	27"	28 1/2"	13 1/2"	22 1/2"	37"	38 1/2"

Model	7	8	9	10	11	12	13	14	15	16	17	18
<b>TBMWB278424(AH or N)</b>	2582	2582	2628	2727	2750	2798	2903	2921	3035	3108	3230	3358
<b>TBMWB308424(AH or N)</b>	2992	2992	3049	3164	3187	3245	3372	3387	3519	3610	3750	3901
<b>TBMWB278724(N)</b>	2848	2848	2902	3009	3036	3093	3207	3223	3350	3433	3568	3710
<b>TBMWB308724(N)</b>	3265	3265	3326	3452	3480	3546	3682	3696	3843	3941	4097	4262
<b>TBMWB279024(N)</b>	3112	3112	3173	3292	3318	3383	3509	3523	3665	3756	3904	4062
<b>TBMWB309024(N)</b>	3538	3538	3605	3740	3772	3843	3990	4006	4166	4274	4444	4624
<b>TBMWB279324(N)</b>	3641	3641	3711	3853	3884	3957	4107	4128	4292	4404	4578	4763
<b>TBMWB309324(N)</b>	4084	4084	4162	4320	4356	4440	4608	4632	4818	4943	5143	5346
<b>TBMWB279624(N)</b>	3641	3641	3711	3853	3884	3957	4107	4128	4292	4404	4578	4763
<b>TBMWB309624(N)</b>	4084	4084	4162	4320	4356	4440	4608	4632	4818	4943	5143	5346

**Custom Modifications**

ACS	ADDTK	AUTHL	AUTHR	CBO	CCO	CFNTO	CFRMO	CND	DRT	DRWTK	EXBKL	EXBKR	EXL	EXR	FB	FFDL	FFDR	FPEB	FTK	FTKAV	FTKRV	ID	INVFRM	MIP	RD	RECTKL	RECTKR	RT	TD	TKP	VTK	WLI	
•*																																	

\*Only available on Narrow Stile (N) cabinets    \*Not available on 93" and 96" tall    \*Not available on 90", 93", and 96" tall

**Construction Upgrades**

APC	ET	PE
•		•

**Door Options**

CG.TOP	DPSRR	MFO
•	•	•

**OVEN MICROWAVE CABINET,  
84", 87", or 90" TALL, 24" DEEP**

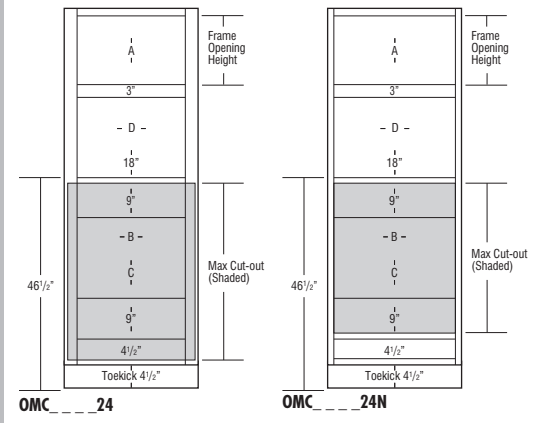
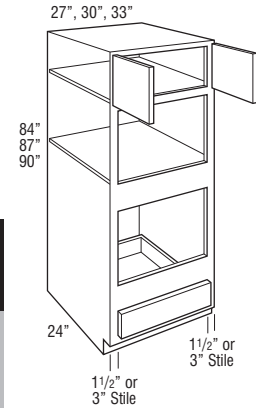

OMC 24      OMC 24N

Model	1	2	3	4	5	6
<b>OMC278424(N)</b>	1731	1818	1928	2223	2223	2223
<b>OMC308424(N)</b>	1819	1922	2012	2463	2439	2576
<b>OMC338424(N)</b>	2102	2222	2276	2651	2657	2810
<b>OMC278724(N)</b>	1909	2010	2173	2452	2445	2452
<b>OMC308724(N)</b>	2011	2126	2273	2680	2659	2810
<b>OMC338724(N)</b>	2303	2434	2550	2905	2905	3077
<b>OMC279024(AH or N)</b>	2088	2202	2414	2680	2669	2680
<b>OMC309024(AH or N)</b>	2203	2328	2533	2898	2875	3043
<b>OMC339024(AH or N)</b>	2502	2644	2822	3163	3156	3346

- AH represents upper section alignment with doors on 24" or 27" high cabinets.
- N represents Narrow Stile cabinets with 1 1/2" wide face frame side stiles and ACS modification availability (see page 50 for ACS specifications). Doors and drawer fronts have a consistent width reveal for full overlay (1/4") and partial overlay (1") and use standard Smart Stop hinges.
- On cabinets with 3" wide face frame side stiles, full overlay styles have a consistent 1/4" width frame reveal and use face mounted Smart Stop hinges. Partial overlay styles have a larger 2 1/2" width reveal, use standard Smart Stop hinges, and are not recommended for stacking applications due to misalignment of door width with cabinets above.
- Cabinets with 3" wide face frames are not available in MDF door styles.
- Upper section on 90" tall has one full depth adjustable shelf.
- Designed for use with separate built-in microwave above, built-in oven below. For built-in double ovens, see pages 398-408.
- All top and bottom cross rails are 1 1/2" wide.
- All toe-kick areas are 4 1/2" high.
- Be sure to confirm a heat shield is built into your appliance by the manufacturer or install the heat shield included with your appliance. Heat shields are sold separately as an accessory.
- Depth can be reduced to a minimum of 12".
- For built-in appliance support, OCINSTALLKIT is included in 24" deep oven cabinets (see page 582 for details). Oven install kit will not be included when depth is modified.
- OCINSTALLKIT weight limit is 400 lbs. per pair.
- Maximum cut-out dimension will allow 1/4" reveal for doors and drawer fronts on full overlay and 1" for partial overlay for trim kit face clearance.

	A Frame Opening Height	B Cut-out Width		C Cut-out Height		D Frame Opening Width	Door Height (Upper Section)	
		Min.	Max.	Min.	Max.		Partial Overlay	Full Overlay
OMC278424	15"	21"	25 1/2"	18"	39"	21"	16"	17 1/2"
OMC308424	15"	24"	28 1/2"	18"	39"	24"	16"	17 1/2"
OMC338424	15"	27"	31 1/2"	18"	39"	27"	16"	17 1/2"
OMC278724	18"	21"	25 1/2"	18"	39"	21"	19"	20 1/2"
OMC308724	18"	24"	28 1/2"	18"	39"	24"	19"	20 1/2"
OMC338724	18"	27"	31 1/2"	18"	39"	27"	19"	20 1/2"
OMC279024AH	21"	21"	25 1/2"	18"	39"	21"	22"	23 1/2"
OMC309024AH	21"	24"	28 1/2"	18"	39"	24"	22"	23 1/2"
OMC339024AH	21"	27"	31 1/2"	18"	39"	27"	22"	23 1/2"

	A Frame Opening Height	B Cut-out Width (standard)		B Cut-out Width (with ACS modification)			C Cut-out Height		Door Height (Upper Section)	
		Min.	Max.	Min.	Max.	Max. w/ Field Cut	Min.	Max.	Partial Overlay	Full Overlay
OMC278424N	15"	24"	25 1/2"	21"	24"	25 1/2"	18"	33"	16"	17 1/2"
OMC308424N	15"	27"	28 1/2"	24"	27"	28 1/2"	18"	33"	16"	17 1/2"
OMC338424N	15"	30"	31 1/2"	27"	30"	31 1/2"	18"	33"	16"	17 1/2"
OMC278724N	18"	24"	25 1/2"	21"	24"	25 1/2"	18"	33"	19"	20 1/2"
OMC308724N	18"	27"	28 1/2"	24"	27"	28 1/2"	18"	33"	19"	20 1/2"
OMC338724N	18"	30"	31 1/2"	27"	30"	31 1/2"	18"	33"	19"	20 1/2"
OMC279024N	21"	24"	25 1/2"	21"	24"	25 1/2"	18"	33"	22"	23 1/2"
OMC309024N	21"	27"	28 1/2"	24"	27"	28 1/2"	18"	33"	22"	23 1/2"
OMC339024N	21"	30"	31 1/2"	27"	30"	31 1/2"	18"	33"	22"	23 1/2"

Model	7	8	9	10	11	12	13	14	15	16	17	18
<b>OMC278424(N)</b>	2347	2347	2389	2479	2499	2543	2639	2655	2759	2826	2936	3053
<b>OMC308424(N)</b>	2720	2720	2771	2876	2897	2949	3065	3079	3199	3281	3408	3547
<b>OMC338424(N)</b>	2965	2965	3019	3132	3158	3219	3341	3355	3488	3580	3721	3868

<b>OMC278724(N)</b>	2589	2589	2638	2735	2760	2811	2915	2930	3046	3121	3245	3373
<b>OMC308724(N)</b>	2968	2968	3024	3139	3164	3223	3347	3360	3493	3584	3725	3875
<b>OMC338724(N)</b>	3251	3251	3311	3436	3466	3532	3665	3684	3828	3930	4087	4249

<b>OMC279024(AH or N)</b>	2830	2830	2884	2992	3017	3074	3190	3204	3333	3415	3550	3692
<b>OMC309024(AH or N)</b>	3216	3216	3277	3400	3429	3493	3628	3642	3786	3886	4041	4203
<b>OMC339024(AH or N)</b>	3538	3538	3604	3740	3773	3847	3991	4008	4168	4280	4452	4630

**Custom Modifications**

ACS	ADDTK	AUTHL AUTHR	CBO	CCO	CFNTD	CFRMO	CND	DRT	DRWTK	EXBKL EXBKR	EXL EXR	FB	FFDL	FPEB	FTK	FTKAV FTKFV	ID	INVERM	MIP	RD	RECTKL RECTKR	RT	TD	TKP	VTK	WLI
•*		•	•	•		•	•		•	•	•			•	•	•	•		•	•	•	•	•	•	•	•

\*Only available on Narrow Stile (N) cabinets

**Construction Upgrades**

APC	ET	PE
•		•

**Door Options**

CG.TOP	DPSRR	MFO
	•	•



**OVEN MICROWAVE CABINET,  
93" or 96" TALL, 24" DEEP**

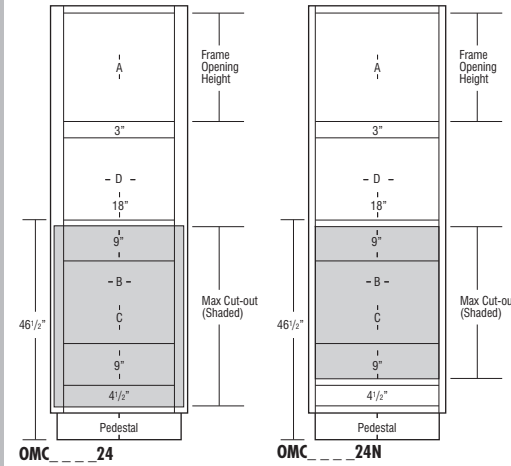
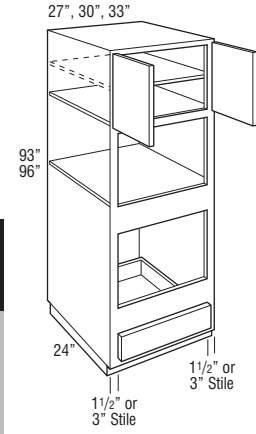

Model	1	2	3	4	5	6
<b>OMC279324(AH or N)</b>	2447	2582	2897	3115	3079	3132
<b>OMC309324(AH or N)</b>	2583	2733	3050	3342	3306	3512
<b>OMC339324(AH or N)</b>	2896	3069	3362	3674	3655	3890

<b>OMC279624(N)</b>	2447	2582	2897	3115	3079	3132
<b>OMC309624(N)</b>	2583	2733	3050	3342	3306	3512
<b>OMC339624(N)</b>	2896	3069	3362	3674	3655	3890

- AH represents upper section alignment with doors on 24" or 27" high cabinets.
- N represents Narrow Stile cabinets with 1 1/2" wide face frame side stiles and ACS modification availability (see page 50 for ACS specifications). Doors and drawer fronts have a consistent width reveal for full overlay (1/4") and partial overlay (1") and use standard Smart Stop hinges.
- On cabinets with 3" wide face frame side stiles, full overlay styles have a consistent 1/4" width frame reveal and use face mounted Smart Stop hinges. Partial overlay styles have a larger 2 1/2" width reveal, use standard Smart Stop hinges, and are not recommended for stacking applications due to misalignment of door width with cabinets above.
- Cabinets with 3" wide face frames are not available in MDF door styles.
- Includes adjustable shelves in upper section:  
93" tall - one shelf  
96" tall - two shelves
- Designed for use with separate built-in microwave above, built-in oven below. For built-in double ovens, see pages 398-408.
- All top and bottom cross rails are 1 1/2" wide.
- All toekick areas are 4 1/2" high.
- Be sure to confirm a heat shield is built into your appliance by the manufacturer or install the heat shield included with your appliance. Heat shields are sold separately as an accessory.
- Separate pedestal base included but packaged separately on 93" and 96" tall. Pedestal is designed to create a Recessed Left or Right Toekick application during field installation, or can be centered. Pedestal must be covered with toeboard material.
- Depth can be reduced to a minimum of 12".
- For built-in appliance support, OCINSTALKIT is included in 24" deep oven cabinets (see page 582 for details). Oven install kit will not be included when depth is modified.
- OCINSTALKIT weight limit is 400 lbs. per pair.
- Maximum cut-out dimension will allow 1/4" reveal for doors and drawer fronts on full overlay and 1" for partial overlay for trim kit face clearance.

	A Frame Opening Height	B Cut-out Width		C Cut-out Height		D Frame Opening Width	Door Height (Upper Section)	
		Min.	Max.	Min.	Max.		Partial Overlay	Full Overlay
OMC279324AH	24"	21"	25 1/2"	18"	39"	21"	25"	26 1/2"
OMC309324AH	24"	24"	28 1/2"	18"	39"	24"	25"	26 1/2"
OMC339324AH	24"	27"	31 1/2"	18"	39"	27"	25"	26 1/2"
OMC279624	27"	21"	25 1/2"	18"	39"	21"	28"	29 1/2"
OMC309624	27"	24"	28 1/2"	18"	39"	24"	28"	29 1/2"
OMC339624	27"	27"	31 1/2"	18"	39"	27"	28"	29 1/2"

	A Frame Opening Height	B Cut-out Width (standard)		B Cut-out Width (with ACS modification)			C Cut-out Height		Door Height (Upper Section)	
		Min.	Max.	Min.	Max.	Max. w/ Field Cut	Min.	Max.	Partial Overlay	Full Overlay
OMC279324N	24"	24"	25 1/2"	21"	24"	25 1/2"	18"	33"	25"	26 1/2"
OMC309324N	24"	27"	28 1/2"	24"	27"	28 1/2"	18"	33"	25"	26 1/2"
OMC339324N	24"	30"	31 1/2"	27"	30"	31 1/2"	18"	33"	25"	26 1/2"
OMC279624N	27"	24"	25 1/2"	21"	24"	25 1/2"	18"	33"	28"	29 1/2"
OMC309624N	27"	27"	28 1/2"	24"	27"	28 1/2"	18"	33"	28"	29 1/2"
OMC339624N	27"	30"	31 1/2"	27"	30"	31 1/2"	18"	33"	28"	29 1/2"

Model	7	8	9	10	11	12	13	14	15	16	17	18
<b>OMC279324(AH or N)</b>	3310	3310	3374	3503	3531	3597	3734	3752	3901	4003	4162	4329
<b>OMC309324(AH or N)</b>	3712	3712	3783	3928	3960	4036	4189	4212	4380	4493	4675	4860
<b>OMC339324(AH or N)</b>	4112	4112	4189	4352	4387	4471	4642	4666	4855	4978	5180	5386

<b>OMC279624(N)</b>	3310	3310	3374	3503	3531	3597	3734	3752	3901	4003	4162	4329
<b>OMC309624(N)</b>	3712	3712	3783	3928	3960	4036	4189	4212	4380	4493	4675	4860
<b>OMC339624(N)</b>	4112	4112	4189	4352	4387	4471	4642	4666	4855	4978	5180	5386

**Custom Modifications**

ACS	ADDTK	AUTHL AUTHR	CBO	CCO	CFNTD	CFRMO	CND	DRT	DRWTK	EXBKL EXBKR	EXL EXR	FB	FFDL FFDR	FPEB	FTK	FTKAV FTKRV	ID	INVFRM	MIP	RD	RECTKL RECTKR	RT	TD	TKP	VTK	WLI
•*		•	•	•		•	•			•	•	•		•			•		•	•	•		•			•

\*Only available on Narrow Stile (N) cabinets

**Construction Upgrades**

APC	ET	PE
•		•

**Door Options**

CG.TOP	DPSRR	MFO
	•	•

**OVEN MICROWAVE CABINET, DEEP DRAWER, 84", 87", or 90" TALL, 24" DEEP**

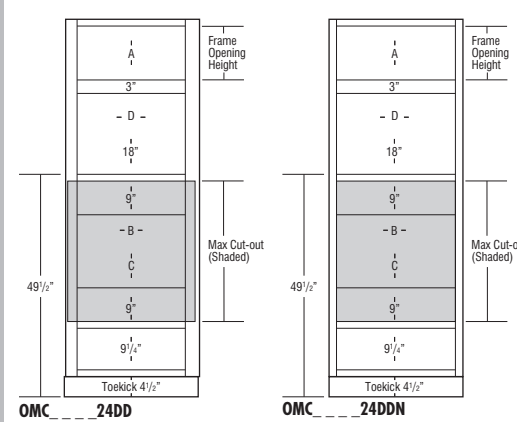
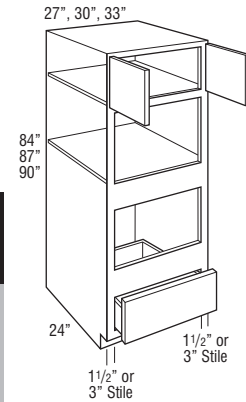

Model	1	2	3	4	5	6
<b>OMC278424DD(N)</b>	1977	2076	2200	2581	2556	2633
<b>OMC308424DD(N)</b>	2162	2276	2376	2868	2848	3105
<b>OMC338424DD(N)</b>	2589	2722	2784	3191	3199	3474
<b>OMC278724DD(N)</b>	2176	2287	2464	2809	2784	2882
<b>OMC308724DD(N)</b>	2375	2498	2663	3107	3086	3361
<b>OMC338724DD(N)</b>	2809	2955	3082	3472	3474	3772
<b>OMC279024DD(N)</b>	2371	2495	2726	3035	3013	3131
<b>OMC309024DD(N)</b>	2585	2722	2948	3348	3322	3618
<b>OMC339024DD(N)</b>	3025	3187	3382	3754	3750	4066

- N represents Narrow Stile cabinets with 1 1/2" wide face frame side stiles and ACS modification availability (see page 50 for ACS specifications). Doors and drawer fronts have a consistent width reveal for full overlay (1/4") and partial overlay (1") and use standard Smart Stop hinges.
- On cabinets with 3" wide face frame side stiles, full overlay styles have a consistent 1/4" width frame reveal and use face mounted Smart Stop hinges. Partial overlay styles have a larger 2 1/2" width reveal, use standard Smart Stop hinges, and are not recommended for stacking applications due to misalignment of door width with cabinets above.
- Designed for use with separate built-in microwave above, built-in oven below. For built-in double ovens, see pages 398-408.
- All top and bottom cross rails are 1 1/2" wide.
- All toe kick areas are 4 1/2" high.
- Be sure to confirm a heat shield is built into your appliance by the manufacturer or install the heat shield included with your appliance. Heat shields are sold separately as an accessory.
- Depth can be reduced to a minimum of 12".
- For built-in appliance support, OCINSTALLKIT is included in 24" deep oven cabinets (see page 582 for details). Oven install kit will not be included when depth is modified.
- OCINSTALLKIT weight limit is 400 lbs. per pair.
- Maximum cut-out dimension will allow 1/4" reveal for doors and drawer fronts on full overlay and 1" for partial overlay for trim kit face clearance.

	A Frame Opening Height	B Cut-out Width		C Cut-out Height		D Frame Opening Width	Door Height (Upper Section)	
		Min.	Max.	Min.	Max.		Partial Overlay	Full Overlay
OMC278424DD	12"	21"	25 1/2"	16 1/4"	31 1/4"	21"	13"	14 1/2"
OMC308424DD	12"	24"	28 1/2"	16 1/4"	31 1/4"	24"	13"	14 1/2"
OMC338424DD	12"	27"	31 1/2"	16 1/4"	31 1/4"	27"	13"	14 1/2"
OMC278724DD	15"	21"	25 1/2"	16 1/4"	31 1/4"	21"	16"	17 1/2"
OMC308724DD	15"	24"	28 1/2"	16 1/4"	31 1/4"	24"	16"	17 1/2"
OMC338724DD	15"	27"	31 1/2"	16 1/4"	31 1/4"	27"	16"	17 1/2"
OMC279024DD	18"	21"	25 1/2"	16 1/4"	31 1/4"	21"	19"	20 1/2"
OMC309024DD	18"	24"	28 1/2"	16 1/4"	31 1/4"	24"	19"	20 1/2"
OMC339024DD	18"	27"	31 1/2"	16 1/4"	31 1/4"	27"	19"	20 1/2"

	A Frame Opening Height	B Cut-out Width (standard)		B Cut-out Width (with ACS modification)			C Cut-out Height		Door Height (Upper Section)	
		Min.	Max.	Min.	Max.	Max. w/ Field Cut	Min.	Max.	Partial Overlay	Full Overlay
OMC278424DDN	12"	24"	25 1/2"	21"	24"	25 1/2"	16 1/4"	31 1/4"	13"	14 1/2"
OMC308424DDN	12"	27"	28 1/2"	24"	27"	28 1/2"	16 1/4"	31 1/4"	13"	14 1/2"
OMC338424DDN	12"	30"	31 1/2"	27"	30"	31 1/2"	16 1/4"	31 1/4"	13"	14 1/2"
OMC278724DDN	15"	24"	25 1/2"	21"	24"	25 1/2"	16 1/4"	31 1/4"	16"	17 1/2"
OMC308724DDN	15"	27"	28 1/2"	24"	27"	28 1/2"	16 1/4"	31 1/4"	16"	17 1/2"
OMC338724DDN	15"	30"	31 1/2"	27"	30"	31 1/2"	16 1/4"	31 1/4"	16"	17 1/2"
OMC279024DDN	18"	24"	25 1/2"	21"	24"	25 1/2"	16 1/4"	31 1/4"	19"	20 1/2"
OMC309024DDN	18"	27"	28 1/2"	24"	27"	28 1/2"	16 1/4"	31 1/4"	19"	20 1/2"
OMC339024DDN	18"	30"	31 1/2"	27"	30"	31 1/2"	16 1/4"	31 1/4"	19"	20 1/2"

Model	7	8	9	10	11	12	13	14	15	16	17	18
<b>OMC278424DD(N)</b>	2766	2766	2816	2913	2933	2984	3086	3104	3218	3294	3413	3539
<b>OMC308424DD(N)</b>	3260	3260	3318	3434	3459	3517	3640	3658	3792	3881	4022	4168
<b>OMC338424DD(N)</b>	3647	3647	3709	3834	3862	3927	4061	4080	4225	4323	4479	4639
<b>OMC278724DD(N)</b>	3030	3030	3086	3194	3219	3275	3392	3406	3532	3618	3753	3891
<b>OMC308724DD(N)</b>	3534	3534	3599	3724	3752	3815	3950	3971	4116	4215	4369	4528
<b>OMC338724DD(N)</b>	3963	3963	4032	4167	4198	4271	4419	4439	4600	4710	4881	5057
<b>OMC279024DD(N)</b>	3298	3298	3357	3477	3503	3565	3694	3709	3849	3942	4092	4242
<b>OMC309024DD(N)</b>	3807	3807	3877	4013	4042	4114	4260	4280	4438	4547	4716	4891
<b>OMC339024DD(N)</b>	4278	4278	4353	4502	4536	4617	4777	4798	4972	5095	5283	5477

**Custom Modifications**

ACS	ADDTK	AUTHL	AUTHR	CBO	CCO	CFNTO	CFRMO	CND	DRT	DRWTK	EXBKL	EXBKR	EXL	EXR	FB	FFDL	FFDR	FPEB	FTK	FTKAV	FTKRV	ID	INVRM	MIP	RD	RECTKL	RECTKR	RT	TD	TKP	VTK	WLU	
•*																																	

\*Only available on Narrow Stile (N) cabinets \*Not available on 84" tall

**Construction Upgrades**

APC	ET	PE
•		•

**Door Options**

CG.TOP	DPSRR	MFO
	•	•

**OVEN MICROWAVE CABINET, DEEP DRAWER, 93" or 96" TALL, 24" DEEP**

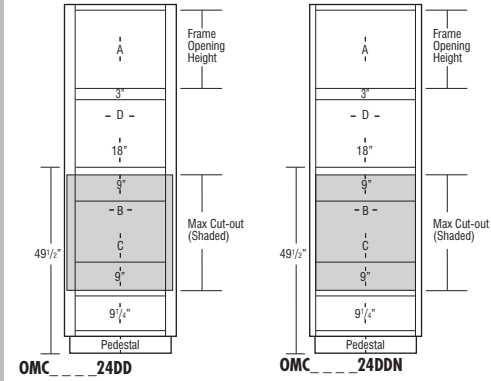
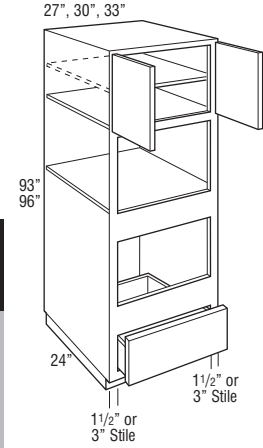

OMC 24DD

OMC 24DDN

Model	1	2	3	4	5	6
OMC279324DD(AH or N)	2767	2915	3259	3500	3462	3632
OMC309324DD(AH or N)	2585	2722	2948	3348	3322	3618
OMC339324DD(AH or N)	3025	3187	3382	3754	3750	4066

OMC279624DD(AH or N)	2767	2915	3259	3500	3462	3632
OMC309624DD(AH or N)	3003	3169	3516	3836	3800	4136
OMC339624DD(AH or N)	3461	3652	3979	4316	4299	4665

- AH represents upper section alignment with doors on 24" or 27" high cabinets.
- N represents Narrow Stile cabinets with 1 1/2" wide face frame side stiles and ACS modification availability (see page 50 for ACS specifications). Doors and drawer fronts have a consistent width reveal for full overlay (1/4") and partial overlay (1") and use standard Smart Stop hinges.
- On cabinets with 3" wide face frame side stiles, full overlay styles have a consistent 1/4" width frame reveal and use face mounted Smart Stop hinges. Partial overlay styles have a larger 2 1/2" width reveal, use standard Smart Stop hinges, and are not recommended for stacking applications due to misalignment of door width with cabinets above.
- Designed for use with separate built-in microwave above, built-in oven below. For built-in double ovens, see pages 398-408.
- All top and bottom cross rails are 1 1/2" wide.
- All toe-kick areas are 4 1/2" high.
- Be sure to confirm a heat shield is built into your appliance by the manufacturer or install the heat shield included with your appliance. Heat shields are sold separately as an accessory.
- Separate pedestal base included but packaged separately on 93" and 96" tall. Pedestal is designed to create a Recessed Left or Right Toe-kick application during field installation, or can be centered. Pedestal must be covered with toeboard material.
- One full depth adjustable shelf included, but packaged separately.
- Depth can be reduced to a minimum of 12".
- For built-in appliance support, OCINSTALLKIT is included in 24" deep oven cabinets (see page 582 for details). Oven install kit will not be included when depth is modified.
- OCINSTALLKIT weight limit is 400 lbs. per pair.
- Maximum cut-out dimension will allow 1/4" reveal for doors and drawer fronts on full overlay and 1" for partial overlay for trim kit face clearance.

	A Frame Opening Height	B Cut-out Width		C Cut-out Height		D Frame Opening Width	Door Height (Upper Section)	
		Min.	Max.	Min.	Max.		Partial Overlay	Full Overlay
OMC279324DDAH	21"	21"	25 1/2"	16 1/4"	31 1/4"	21"	22"	23 1/2"
OMC309324DDAH	21"	24"	28 1/2"	16 1/4"	31 1/4"	24"	22"	23 1/2"
OMC339324DDAH	21"	27"	31 1/2"	16 1/4"	31 1/4"	27"	22"	23 1/2"
OMC279624DDAH	24"	21"	25 1/2"	16 1/4"	31 1/4"	21"	25"	26 1/2"
OMC309624DDAH	24"	24"	28 1/2"	16 1/4"	31 1/4"	24"	25"	26 1/2"
OMC339624DDAH	24"	27"	31 1/2"	16 1/4"	31 1/4"	27"	25"	26 1/2"

	A Frame Opening Height	B Cut-out Width (standard)		B Cut-out Width (with ACS modification)			C Cut-out Height		Door Height (Upper Section)	
		Min.	Max.	Min.	Max.	Max. w/ Field Cut	Min.	Max.	Partial Overlay	Full Overlay
OMC279324DDN	21"	24"	25 1/2"	21"	24"	25 1/2"	16 1/4"	31 1/4"	22"	23 1/2"
OMC309324DDN	21"	27"	28 1/2"	24"	27"	28 1/2"	16 1/4"	31 1/4"	22"	23 1/2"
OMC339324DDN	21"	30"	31 1/2"	27"	30"	31 1/2"	16 1/4"	31 1/4"	22"	23 1/2"
OMC279624DDN	24"	24"	25 1/2"	21"	24"	25 1/2"	16 1/4"	31 1/4"	25"	26 1/2"
OMC309624DDN	24"	27"	28 1/2"	24"	27"	28 1/2"	16 1/4"	31 1/4"	25"	26 1/2"
OMC339624DDN	24"	30"	31 1/2"	27"	30"	31 1/2"	16 1/4"	31 1/4"	25"	26 1/2"

Model	7	8	9	10	11	12	13	14	15	16	17	18
OMC279324DD(AH or N)	3828	3828	3894	4037	4068	4142	4293	4312	4474	4587	4763	4941
OMC309324DD(AH or N)	3807	3807	3877	4013	4042	4114	4260	4280	4438	4547	4716	4891
OMC339324DD(AH or N)	4278	4278	4353	4502	4536	4617	4777	4798	4972	5095	5283	5477

OMC279624DD(AH or N)	3828	3828	3894	4037	4068	4142	4293	4312	4474	4587	4763	4941
OMC309624DD(AH or N)	4356	4356	4434	4593	4629	4711	4881	4903	5089	5213	5412	5614
OMC339624DD(AH or N)	4910	4910	4997	5173	5214	5305	5494	5521	5727	5863	6084	6308

**Custom Modifications**

ACS	ADDTK	AUTHL AUTHR	CBO	CCO	CFNTO	CFRMO	CND	DRT	DRWTK	EXBKL EXBKR	EXL EXR	FB	FFDL FFDR	FPEB	FTK	FTKAV FTKRV	ID	INVFRM	MIP	RD	RECTKL RECTKR	RT	TD	TKP	VTK	WLI
•*		•	•	•		•	•			•	•	•		•			•		•	•	•		•			•

\*Only available on Narrow Stile (N) cabinets

**Construction Upgrades**

APC	ET	PE
•		•

**Door Options**

CG.TOP	DPSRR	MFO
	•	•

**OVEN MICROWAVE CABINET,  
WARMING DRAWER, 84", 87", 90",  
93", or 96" TALL, 24" DEEP**

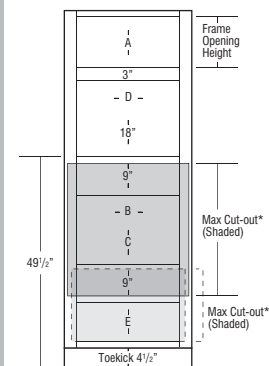
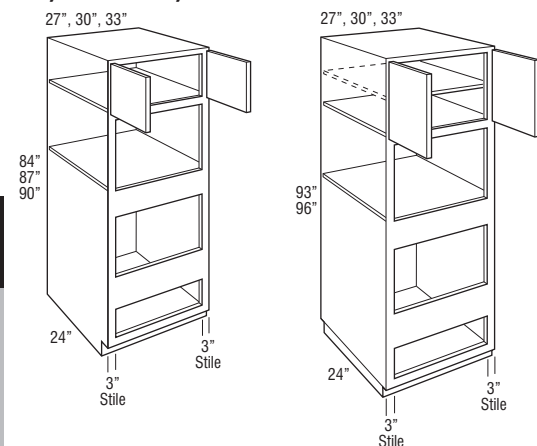

\*Minimum rail height between oven and warming drawer is 1 1/2"

Model	1	2	3	4	5	6
<b>OMC278424WD</b>	1687	1786	1910	2291	2266	2343
<b>OMC308424WD</b>	1787	1900	2000	2491	2472	2729
<b>OMC338424WD</b>	2097	2231	2292	2699	2709	2984
<b>OMC278724WD</b>	1886	1998	2175	2519	2494	2592
<b>OMC308724WD</b>	1999	2124	2287	2731	2711	2986
<b>OMC338724WD</b>	2316	2464	2591	2981	2984	3279
<b>OMC279024WD</b>	2082	2206	2437	2745	2723	2842
<b>OMC309024WD</b>	2208	2346	2571	2971	2947	3243
<b>OMC339024WD</b>	2535	2694	2890	3261	3257	3575
<b>OMC279324WDAH</b>	2478	2625	2970	3210	3173	3343
<b>OMC309324WDAH</b>	2626	2792	3140	3460	3423	3759
<b>OMC339324WDAH</b>	2969	3162	3486	3825	3808	4174
<b>OMC279624WDAH</b>	2478	2625	2970	3210	3173	3343
<b>OMC309624WDAH</b>	2626	2792	3140	3460	3423	3759
<b>OMC339624WDAH</b>	2969	3162	3486	3825	3808	4174

- AH represents upper section alignment with doors on 24" or 27" high cabinets.
- Includes one adjustable shelf in upper section of 93" and 96" tall.
- Designed for use with separate built-in microwave above, built-in oven below. For built-in double ovens, see pages 398-408.
- Full overlay styles feature concealed face mount Smart Stop hinges.
- All top and bottom cross rails are 1 1/2" wide.
- All toe-kick areas are 4 1/2" high.
- Be sure to confirm a heat shield is built into your appliance by the manufacturer or install the heat shield included with your appliance. Heat shields are sold separately as an accessory.
- Separate pedestal base included but packaged separately on 93" and 96" tall. Pedestal is designed to create a Recessed Left or Right Toe-kick application during field installation, or can be centered. Pedestal must be covered with toeboard material.
- Depth can be reduced to a minimum of 6". For depths of 6"-8", cabinet will not include toe-kick/pedestal.
- For built-in appliance support, OCINSTALLKIT is included in 24" deep oven cabinets (see page 582 for details). Oven install kit will not be included when depth is modified.
- OCINSTALLKIT weight limit is 400 lbs. per pair.

	A		B			C		D		E		Door Height	
	Frame Opening Height	Cut-out Width		Cut-out Height		Frame Opening Width	Warming Drawer Cut-out Height		Door Height (Upper Section)		Partial Overlay	Full Overlay	
		Min.	Max.	Min.	Max.		Min.	Max.	Min.	Max.			
OMC278424WD	12"	21"	25 1/2"	16 1/4"	31 1/4"	21"	9 1/4"	16 3/4"	13"	14 1/2"			
OMC308424WD	12"	24"	28 1/2"	16 1/4"	31 1/4"	24"	9 1/4"	16 3/4"	13"	14 1/2"			
OMC338424WD	12"	27"	31 1/2"	16 1/4"	31 1/4"	27"	9 1/4"	16 3/4"	13"	14 1/2"			
OMC278724WD	15"	21"	25 1/2"	16 1/4"	31 1/4"	21"	9 1/4"	16 3/4"	16"	17 1/2"			
OMC308724WD	15"	24"	28 1/2"	16 1/4"	31 1/4"	24"	9 1/4"	16 3/4"	16"	17 1/2"			
OMC338724WD	15"	27"	31 1/2"	16 1/4"	31 1/4"	27"	9 1/4"	16 3/4"	16"	17 1/2"			
OMC279024WD	18"	21"	25 1/2"	16 1/4"	31 1/4"	21"	9 1/4"	16 3/4"	19"	20 1/2"			
OMC309024WD	18"	24"	28 1/2"	16 1/4"	31 1/4"	24"	9 1/4"	16 3/4"	19"	20 1/2"			
OMC339024WD	18"	27"	31 1/2"	16 1/4"	31 1/4"	27"	9 1/4"	16 3/4"	19"	20 1/2"			
OMC279324WDAH	21"	21"	25 1/2"	16 1/4"	31 1/4"	21"	9 1/4"	16 3/4"	22"	23 1/2"			
OMC309324WDAH	21"	24"	28 1/2"	16 1/4"	31 1/4"	24"	9 1/4"	16 3/4"	22"	23 1/2"			
OMC339324WDAH	21"	27"	31 1/2"	16 1/4"	31 1/4"	27"	9 1/4"	16 3/4"	22"	23 1/2"			
OMC279624WDAH	24"	21"	25 1/2"	16 1/4"	31 1/4"	21"	9 1/4"	16 3/4"	25"	26 1/2"			
OMC309624WDAH	24"	24"	28 1/2"	16 1/4"	31 1/4"	24"	9 1/4"	16 3/4"	25"	26 1/2"			
OMC339624WDAH	24"	27"	31 1/2"	16 1/4"	31 1/4"	27"	9 1/4"	16 3/4"	25"	26 1/2"			

Maximum cut-out dimension will allow 1/4" reveal for doors and drawer fronts on full overlay and 1" for partial overlay for trim kit face clearance.

Model	7	8	9	10	11	12	13	14	15	16	17	18
<b>OMC278424WD</b>	2477	2477	2527	2623	2643	2694	2797	2815	2928	3004	3124	3250
<b>OMC308424WD</b>	2885	2885	2943	3058	3082	3141	3264	3283	3416	3506	3646	3792
<b>OMC338424WD</b>	3156	3156	3218	3343	3371	3434	3569	3588	3734	3832	3988	4147
<b>OMC278724WD</b>	2742	2742	2797	2904	2929	2986	3102	3117	3245	3331	3463	3602
<b>OMC308724WD</b>	3158	3158	3223	3348	3375	3439	3575	3595	3740	3838	3992	4153
<b>OMC338724WD</b>	3470	3470	3540	3676	3707	3779	3928	3946	4107	4218	4390	4566
<b>OMC279024WD</b>	3009	3009	3069	3188	3215	3276	3404	3420	3559	3653	3803	3953
<b>OMC309024WD</b>	3431	3431	3501	3637	3665	3739	3884	3904	4062	4170	4339	4514
<b>OMC339024WD</b>	3785	3785	3861	4009	4045	4125	4285	4306	4479	4603	4792	4984
<b>OMC279324WDAH</b>	3539	3539	3605	3749	3779	3854	4004	4022	4185	4297	4473	4651
<b>OMC309324WDAH</b>	3980	3980	4058	4218	4255	4335	4507	4526	4713	4839	5036	5239
<b>OMC339324WDAH</b>	4419	4419	4507	4681	4723	4814	5004	5029	5235	5371	5593	5817
<b>OMC279624WDAH</b>	3539	3539	3605	3749	3779	3854	4004	4022	4185	4297	4473	4651
<b>OMC309624WDAH</b>	3980	3980	4058	4218	4255	4335	4507	4526	4713	4839	5036	5239
<b>OMC339624WDAH</b>	4419	4419	4507	4681	4723	4814	5004	5029	5235	5371	5593	5817

**Custom Modifications**

ACS	ADDTK	AUTHL	AUTHR	CBO	CCO	CFNTO	CFRMO	CND	DRT	DRWTK	EXBKL	EXBKR	EXL	EXR	FB	FFDL	FFDR	FPEB	FTK	FTKAV	FTKRV	ID	INVFRM	MIP	RD	RECTKL	RECTKR	RT	TD	TKP	VTK	WLI	

\*Not available on 84", 87", and 90" tall    \*Not available on 93" and 96" tall    \*Not available on 84" tall

**Construction Upgrades**

APC	ET	PE

**Door Options**

CG.TOP	DPSRR	MFO

## OFFICE & FURNITURE CABINET NOMENCLATURE

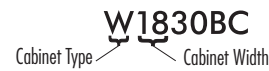

### NOTE:

If order is placed in Arch door style, Office and Furniture bases will have Square doors.

All bookcase shelves are 3/4" thick plywood with 1 1/2" tall solid-wood rail attached.

All office base cabinets are predrilled for full depth shelves or roll trays.

## MODIFICATIONS GRID KEY

- Available Standard on these cabinets
- 5 DAY 5 Day Express Response Item

## CUSTOM MODIFICATIONS

Mod.	Description	Mod.	Description	Mod.	Description
ADDTK	Add Toekick	EXL	Extended Stile - Left	PTOWB	Push to Open Wastebasket
AUTHL	Authentic End - Left	EXR	Extended Stile - Right	RD	Reduced Depth
AUTHR	Authentic End - Right	FB	Finished Ends	RECTKALL	Recessed Island Toekick
CBO	Cabinet Box Only	FFDL	Face Frame and Door on End - Left	RECTKBK	Recessed Toekick - Back
CCO	Cabinet Case Only	FFDR	Face Frame and Door on End - Right	RECTKL	Recessed Toekick - Left
CFNTO	Cabinet Front Only	FPEB	Furniture Finished Plywood Ends	RECTKR	Recessed Toekick - Right
CFP	Cabinet False Panel	FTK	Flush Toekick	RT	Installed Roll Tray
CFRMO	Cabinet Frame Only	FTKAV	Flush Toekick Arch	TVRAV	Valance Top Rail, Arch
CND	Cabinet with No Door, with Drawer	FTKRV	Flush Toekick Furniture	TVRFV	Valance Top Rail, Furniture
DRWSEC	Biometric Secured Drawer	ID	Increased Depth	TVRVV	Valance Top Rail, Straight
DRWTK	Toekick Drawer	INVFRM	Inverted Frame	VTK	Void Toekick
EXBKL	End Extended Back - Left	LTI	Light Installed Battery Strip	WLI	White Laminate Interior
EXBKR	End Extended Back - Right	MIP	Matching Interior Plywood		
		PFINBTMB	Prepare Cabinet for Finished Bottom		

## CONSTRUCTION UPGRADES

Mod.	Description
APC	All-plywood Construction
PE	Plywood Ends

## DOOR OPTIONS

Mod.	Description
DPSRR	Door Panel - Solid Reverse Raised

### BOOKCASE, 30" HIGH, 12" DEEP

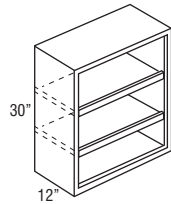

Model	1	2	3	4	5	6
W1830BC	988	988	988	988	988	988
<b>NEW</b> W2130BC	1030	1030	1030	1030	1030	1030
W2430BC	1071	1071	1071	1071	1071	1071
<b>NEW</b> W2730BC	1129	1129	1129	1129	1129	1129
W3030BC	1187	1187	1187	1187	1187	1187
<b>NEW</b> W3330BC	1223	1223	1223	1223	1223	1223
W3630BC	1258	1258	1258	1258	1258	1258

- Matching Interior Plywood (MIP) standard.
- Face frame has a profiled inside edge.
- If ordered with Heirloom Technique, will not feature sand-through characteristics.
- To change the top rail valance, specify one of the following modifications: Arch (TVRAV), Furniture (TVRFV), or Straight Valance (TVRVV).

Model	7	8	9	10	11	12	13	14	15	16	17	18
W1830BC	988	988	988	988	988	988	988	988	988	988	988	988
W2130BC	1030	1030	1030	1030	1030	1030	1030	1030	1030	1030	1030	1030
W2430BC	1071	1071	1071	1071	1071	1071	1071	1071	1071	1071	1071	1071
W2730BC	1129	1129	1129	1129	1129	1129	1129	1129	1129	1129	1129	1129
W3030BC	1187	1187	1187	1187	1187	1187	1187	1187	1187	1187	1187	1187
W3330BC	1223	1223	1223	1223	1223	1223	1223	1223	1223	1223	1223	1223
W3630BC	1258	1258	1258	1258	1258	1258	1258	1258	1258	1258	1258	1258

### Custom Modifications

ADDTK	AUTHL	AUTHR	CBO	CCO	CFNTO	CFP	CFRMO	CND	DRWSEC	DRWTK	EXBKL	EXBKR	EXL	EXR	FB	FFDL	FFDR	FPEB	FTK	FTKAV	FTKRV	ID	INVFRM	LTI	MIP	PFINBTMB	PTOWB	RD	RECTKALL	RECTKBK	RECTKL	RECTKR	RT	TVRAV	TVRFV	TVRVV	VTK	WLI
•	•						•				•	•						•				•			STD	•		•						•				

### Construction Upgrades

APC	PE
-----	----

### Door Options

DPSRR
-------

W1848BC	1231	1231	1231	1231	1231	1231	1231	1231	1231	1231	1231	1231
W2148BC	1284	1284	1284	1284	1284	1284	1284	1284	1284	1284	1284	1284
W2448BC	1336	1336	1336	1336	1336	1336	1336	1336	1336	1336	1336	1336
W2748BC	1409	1409	1409	1409	1409	1409	1409	1409	1409	1409	1409	1409
W3048BC	1482	1482	1482	1482	1482	1482	1482	1482	1482	1482	1482	1482
W3348BC	1528	1528	1528	1528	1528	1528	1528	1528	1528	1528	1528	1528
W3648BC	1574	1574	1574	1574	1574	1574	1574	1574	1574	1574	1574	1574

### Custom Modifications

ADDTK	AUTHL	AUTHR	CBO	CCO	CFNTO	CFP	CFRMO	CND	DRWSEC	DRWTK	EXBKL	EXBKR	EXL	EXR	FB	FFDL	FFDR	FPEB	FTK	FTKAV	FTKRV	ID	INVFRM	LTI	MIP	PFINBTMB	PTOWB	RD	RECTKALL	RECTKBK	RECTKL	RECTKR	RT	TVRAV	TVRFV	TVRVV	VTK	WLI
•	•						•				•	•						•				•			STD	•		•						•				

### Construction Upgrades

APC	PE
-----	----

### Door Options

DPSRR
-------

### BOOKCASE, 48" HIGH, 12" DEEP

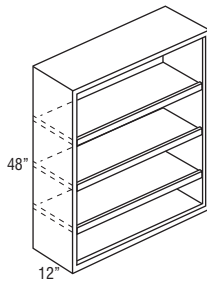

Model	1	2	3	4	5	6
W1848BC	1231	1231	1231	1231	1231	1231
<b>NEW</b> W2148BC	1284	1284	1284	1284	1284	1284
W2448BC	1336	1336	1336	1336	1336	1336
<b>NEW</b> W2748BC	1409	1409	1409	1409	1409	1409
W3048BC	1482	1482	1482	1482	1482	1482
<b>NEW</b> W3348BC	1528	1528	1528	1528	1528	1528
W3648BC	1574	1574	1574	1574	1574	1574

- Matching Interior Plywood (MIP) standard.
- Face frame has a profiled inside edge.
- If ordered with Heirloom Technique, will not feature sand-through characteristics.
- To change the top rail valance, specify one of the following modifications: Arch (TVRAV), Furniture (TVRFV), or Straight Valance (TVRVV).

**WALL FURNITURE BOOKCASE, 48", 51", or 54" HIGH, 12" DEEP**

18", 21", 24", 27", 30", 33", or 36"

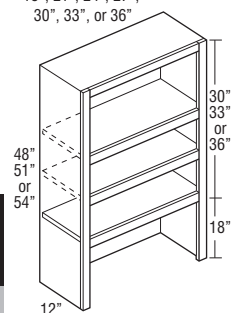

Model	1	2	3	4	5	6
WFBC1848	1287	1287	1287	1287	1287	1287
<b>NEW</b> WFBC2148	1340	1340	1340	1340	1340	1340
WFBC2448	1392	1392	1392	1392	1392	1392
<b>NEW</b> WFBC2748	1462	1462	1462	1462	1462	1462
WFBC3048	1532	1532	1532	1532	1532	1532
<b>NEW</b> WFBC3348	1578	1578	1578	1578	1578	1578
WFBC3648	1624	1624	1624	1624	1624	1624
WFBC1851	1338	1338	1338	1338	1338	1338
<b>NEW</b> WFBC2151	1392	1392	1392	1392	1392	1392
WFBC2451	1445	1445	1445	1445	1445	1445
<b>NEW</b> WFBC2751	1518	1518	1518	1518	1518	1518
WFBC3051	1590	1590	1590	1590	1590	1590
<b>NEW</b> WFBC3351	1637	1637	1637	1637	1637	1637
WFBC3651	1684	1684	1684	1684	1684	1684
WFBC1854	1388	1388	1388	1388	1388	1388
<b>NEW</b> WFBC2154	1442	1442	1442	1442	1442	1442
WFBC2454	1495	1495	1495	1495	1495	1495
<b>NEW</b> WFBC2754	1571	1571	1571	1571	1571	1571
WFBC3054	1646	1646	1646	1646	1646	1646
<b>NEW</b> WFBC3354	1696	1696	1696	1696	1696	1696
WFBC3654	1745	1745	1745	1745	1745	1745

- 48", 51", and 54" have two adjustable shelves and one fixed shelf.
- Matching Interior Plywood (MIP) standard.
- Face frame has a profiled inside edge.
- If ordered with Heirlooming Technique, will not feature sand-through characteristics.
- To change the top rail valance, specify one of the following modifications: Arch (TVRAV), Furniture (TVRFV), or Straight Valance (TVRVV).
- Bookcases can only be reduced to 9".

Model	7	8	9	10	11	12	13	14	15	16	17	18
WFBC1848	1287	1287	1287	1287	1287	1287	1287	1287	1287	1287	1287	1287
WFBC2148	1340	1340	1340	1340	1340	1340	1340	1340	1340	1340	1340	1340
WFBC2448	1392	1392	1392	1392	1392	1392	1392	1392	1392	1392	1392	1392
WFBC2748	1462	1462	1462	1462	1462	1462	1462	1462	1462	1462	1462	1462
WFBC3048	1532	1532	1532	1532	1532	1532	1532	1532	1532	1532	1532	1532
WFBC3348	1578	1578	1578	1578	1578	1578	1578	1578	1578	1578	1578	1578
WFBC3648	1624	1624	1624	1624	1624	1624	1624	1624	1624	1624	1624	1624
WFBC1851	1338	1338	1338	1338	1338	1338	1338	1338	1338	1338	1338	1338
WFBC2151	1392	1392	1392	1392	1392	1392	1392	1392	1392	1392	1392	1392
WFBC2451	1445	1445	1445	1445	1445	1445	1445	1445	1445	1445	1445	1445
WFBC2751	1518	1518	1518	1518	1518	1518	1518	1518	1518	1518	1518	1518
WFBC3051	1590	1590	1590	1590	1590	1590	1590	1590	1590	1590	1590	1590
WFBC3351	1637	1637	1637	1637	1637	1637	1637	1637	1637	1637	1637	1637
WFBC3651	1684	1684	1684	1684	1684	1684	1684	1684	1684	1684	1684	1684
WFBC1854	1388	1388	1388	1388	1388	1388	1388	1388	1388	1388	1388	1388
WFBC2154	1442	1442	1442	1442	1442	1442	1442	1442	1442	1442	1442	1442
WFBC2454	1495	1495	1495	1495	1495	1495	1495	1495	1495	1495	1495	1495
WFBC2754	1571	1571	1571	1571	1571	1571	1571	1571	1571	1571	1571	1571
WFBC3054	1646	1646	1646	1646	1646	1646	1646	1646	1646	1646	1646	1646
WFBC3354	1696	1696	1696	1696	1696	1696	1696	1696	1696	1696	1696	1696
WFBC3654	1745	1745	1745	1745	1745	1745	1745	1745	1745	1745	1745	1745

**Custom Modifications**

ADDTK	AUTHL AUTHR	CBO	CCO	CFNT0	CFP	CFRMO	CND	DRWSEC	DRWTK	EXBKL EXBKR	EXL EXR	FB	FFDL	FPEB	FTK	FTKAV FTKVF	ID	INVFRM	LTI	MIP	PFINBTMB	PTOWB	RD	RECTKALL RECTKBK	RECTKL RECTKR	RT	TVRAV TVRFV TVRVV	VTK	WLI
	•	STD				•				•	•			•			•			STD			•			•			

**Construction Upgrades**

APC	PE

**Door Options**

DPSRR

**WALL FURNITURE BOOKCASE, 57", 60", or 66" HIGH, 12" DEEP**

18", 21", 24", 27", 30", 33", or 36"

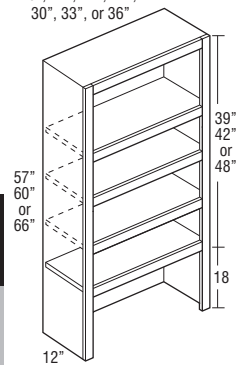

Model	1	2	3	4	5	6
WFBC1857	1524	1524	1524	1524	1524	1524
<b>NEW</b> WFBC2157	1585	1585	1585	1585	1585	1585
WFBC2457	1645	1645	1645	1645	1645	1645
<b>NEW</b> WFBC2757	1727	1727	1727	1727	1727	1727
WFBC3057	1809	1809	1809	1809	1809	1809
<b>NEW</b> WFBC3357	1864	1864	1864	1864	1864	1864
WFBC3657	1918	1918	1918	1918	1918	1918
WFBC1860	1540	1540	1540	1540	1540	1540
<b>NEW</b> WFBC2160	1602	1602	1602	1602	1602	1602
WFBC2460	1664	1664	1664	1664	1664	1664
<b>NEW</b> WFBC2760	1748	1748	1748	1748	1748	1748
WFBC3060	1831	1831	1831	1831	1831	1831
<b>NEW</b> WFBC3360	1886	1886	1886	1886	1886	1886
WFBC3660	1940	1940	1940	1940	1940	1940
WFBC1866	1694	1694	1694	1694	1694	1694
<b>NEW</b> WFBC2166	1763	1763	1763	1763	1763	1763
WFBC2466	1832	1832	1832	1832	1832	1832
<b>NEW</b> WFBC2766	1922	1922	1922	1922	1922	1922
WFBC3066	2012	2012	2012	2012	2012	2012
<b>NEW</b> WFBC3366	2074	2074	2074	2074	2074	2074
WFBC3666	2136	2136	2136	2136	2136	2136

- 57", 60", and 66" have three adjustable shelves and one fixed shelf.
- Matching Interior Plywood (MIP) standard.
- Face frame has a profiled inside edge.
- If ordered with Heirlooming Technique, will not feature sand-through characteristics.
- To change the top rail valance, specify one of the following modifications: Arch (TVRAV), Furniture (TVRFV), or Straight Valance (TVRVV).
- Bookcases can only be reduced to 9".

Model	7	8	9	10	11	12	13	14	15	16	17	18
WFBC1857	1524	1524	1524	1524	1524	1524	1524	1524	1524	1524	1524	1524
WFBC2157	1585	1585	1585	1585	1585	1585	1585	1585	1585	1585	1585	1585
WFBC2457	1645	1645	1645	1645	1645	1645	1645	1645	1645	1645	1645	1645
WFBC2757	1727	1727	1727	1727	1727	1727	1727	1727	1727	1727	1727	1727
WFBC3057	1809	1809	1809	1809	1809	1809	1809	1809	1809	1809	1809	1809
WFBC3357	1864	1864	1864	1864	1864	1864	1864	1864	1864	1864	1864	1864
WFBC3657	1918	1918	1918	1918	1918	1918	1918	1918	1918	1918	1918	1918
WFBC1860	1540	1540	1540	1540	1540	1540	1540	1540	1540	1540	1540	1540
WFBC2160	1602	1602	1602	1602	1602	1602	1602	1602	1602	1602	1602	1602
WFBC2460	1664	1664	1664	1664	1664	1664	1664	1664	1664	1664	1664	1664
WFBC2760	1748	1748	1748	1748	1748	1748	1748	1748	1748	1748	1748	1748
WFBC3060	1831	1831	1831	1831	1831	1831	1831	1831	1831	1831	1831	1831
WFBC3360	1886	1886	1886	1886	1886	1886	1886	1886	1886	1886	1886	1886
WFBC3660	1940	1940	1940	1940	1940	1940	1940	1940	1940	1940	1940	1940
WFBC1866	1694	1694	1694	1694	1694	1694	1694	1694	1694	1694	1694	1694
WFBC2166	1763	1763	1763	1763	1763	1763	1763	1763	1763	1763	1763	1763
WFBC2466	1832	1832	1832	1832	1832	1832	1832	1832	1832	1832	1832	1832
WFBC2766	1922	1922	1922	1922	1922	1922	1922	1922	1922	1922	1922	1922
WFBC3066	2012	2012	2012	2012	2012	2012	2012	2012	2012	2012	2012	2012
WFBC3366	2074	2074	2074	2074	2074	2074	2074	2074	2074	2074	2074	2074
WFBC3666	2136	2136	2136	2136	2136	2136	2136	2136	2136	2136	2136	2136

**Custom Modifications**

ADDTK	AUTHL AUTHR	CBO	CCO	CFNT0	CFP	CFRMO	CND	DRWSEC	DRWTK	EXBKL EXBKR	EXL EXR	FB	FFDL FFDR	FPEB	FTK	FTKAV FTKRV	ID	INVRM	LTI	MIP	PFINBTMB	PTOWB	RD	RECTKALL RECTKKB	RECTKL RECTKR	RT	TVRAV TVRFV TVRVV	VTK	WLI
	•*	STD				•				•	•			•			•			STD			•			•			

\*Not available on 66" high

**Construction Upgrades**

APC	PE
-----	----

**Door Options**

DPSRR
-------

**TALL BOOKCASE, 84", 87", or 90" HIGH, 12" or 18" DEEP**

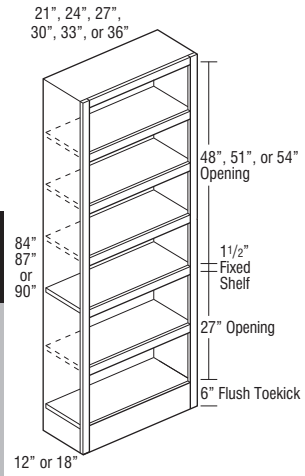

12" or 18"

Model	1	2	3	4	5	6
<b>NEW</b> TBC218412	2593	2593	2593	2593	2593	2593
TBC248412	2712	2712	2712	2712	2712	2712
<b>NEW</b> TBC278412	2858	2858	2858	2858	2858	2858
TBC308412	3004	3004	3004	3004	3004	3004
<b>NEW</b> TBC338412	3096	3096	3096	3096	3096	3096
TBC368412	3188	3188	3188	3188	3188	3188
<b>NEW</b> TBC218418	3110	3110	3110	3110	3110	3110
TBC248418	3253	3253	3253	3253	3253	3253
<b>NEW</b> TBC278418	3430	3430	3430	3430	3430	3430
TBC308418	3606	3606	3606	3606	3606	3606
<b>NEW</b> TBC338418	3716	3716	3716	3716	3716	3716
TBC368418	3825	3825	3825	3825	3825	3825
<b>NEW</b> TBC218712	2641	2641	2641	2641	2641	2641
TBC248712	2761	2761	2761	2761	2761	2761
<b>NEW</b> TBC278712	2909	2909	2909	2909	2909	2909
TBC308712	3057	3057	3057	3057	3057	3057
<b>NEW</b> TBC338712	3150	3150	3150	3150	3150	3150
TBC368712	3243	3243	3243	3243	3243	3243
<b>NEW</b> TBC218718	3165	3165	3165	3165	3165	3165
TBC248718	3310	3310	3310	3310	3310	3310
<b>NEW</b> TBC278718	3490	3490	3490	3490	3490	3490
TBC308718	3670	3670	3670	3670	3670	3670
<b>NEW</b> TBC338718	3781	3781	3781	3781	3781	3781
TBC368718	3891	3891	3891	3891	3891	3891
<b>NEW</b> TBC219012	2687	2687	2687	2687	2687	2687
TBC249012	2809	2809	2809	2809	2809	2809
<b>NEW</b> TBC279012	2960	2960	2960	2960	2960	2960
TBC309012	3110	3110	3110	3110	3110	3110
<b>NEW</b> TBC339012	3204	3204	3204	3204	3204	3204
TBC369012	3298	3298	3298	3298	3298	3298
<b>NEW</b> TBC219018	3220	3220	3220	3220	3220	3220
TBC249018	3367	3367	3367	3367	3367	3367
<b>NEW</b> TBC279018	3551	3551	3551	3551	3551	3551
TBC309018	3734	3734	3734	3734	3734	3734
<b>NEW</b> TBC339018	3846	3846	3846	3846	3846	3846
TBC369018	3957	3957	3957	3957	3957	3957

- 84" and 87" tall include four adjustable shelves and one fixed shelf.
- 90" tall includes five adjustable shelves and one fixed shelf.
- Matching Interior Plywood (MIP) standard.
- Face frame has a profiled inside edge.
- If ordered with Heirloom Technique, will not feature sand-through characteristics.
- To change the top rail valance, specify one of the following modifications: Arch (TVRAV), Furniture (TVRFV), or Straight Valance (TVRVV).
- Bookcases can only be reduced to 9".

Model	7	8	9	10	11	12	13	14	15	16	17	18
TBC218412	2593	2593	2593	2593	2593	2593	2593	2593	2593	2593	2593	2593
TBC248412	2712	2712	2712	2712	2712	2712	2712	2712	2712	2712	2712	2712
TBC278412	2858	2858	2858	2858	2858	2858	2858	2858	2858	2858	2858	2858
TBC308412	3004	3004	3004	3004	3004	3004	3004	3004	3004	3004	3004	3004
TBC338412	3096	3096	3096	3096	3096	3096	3096	3096	3096	3096	3096	3096
TBC368412	3188	3188	3188	3188	3188	3188	3188	3188	3188	3188	3188	3188

TBC218418	3110	3110	3110	3110	3110	3110	3110	3110	3110	3110	3110	3110
TBC248418	3253	3253	3253	3253	3253	3253	3253	3253	3253	3253	3253	3253
TBC278418	3430	3430	3430	3430	3430	3430	3430	3430	3430	3430	3430	3430
TBC308418	3606	3606	3606	3606	3606	3606	3606	3606	3606	3606	3606	3606
TBC338418	3716	3716	3716	3716	3716	3716	3716	3716	3716	3716	3716	3716
TBC368418	3825	3825	3825	3825	3825	3825	3825	3825	3825	3825	3825	3825

TBC218712	2641	2641	2641	2641	2641	2641	2641	2641	2641	2641	2641	2641
TBC248712	2761	2761	2761	2761	2761	2761	2761	2761	2761	2761	2761	2761
TBC278712	2909	2909	2909	2909	2909	2909	2909	2909	2909	2909	2909	2909
TBC308712	3057	3057	3057	3057	3057	3057	3057	3057	3057	3057	3057	3057
TBC338712	3150	3150	3150	3150	3150	3150	3150	3150	3150	3150	3150	3150
TBC368712	3243	3243	3243	3243	3243	3243	3243	3243	3243	3243	3243	3243

TBC218718	3165	3165	3165	3165	3165	3165	3165	3165	3165	3165	3165	3165
TBC248718	3310	3310	3310	3310	3310	3310	3310	3310	3310	3310	3310	3310
TBC278718	3490	3490	3490	3490	3490	3490	3490	3490	3490	3490	3490	3490
TBC308718	3670	3670	3670	3670	3670	3670	3670	3670	3670	3670	3670	3670
TBC338718	3781	3781	3781	3781	3781	3781	3781	3781	3781	3781	3781	3781
TBC368718	3891	3891	3891	3891	3891	3891	3891	3891	3891	3891	3891	3891

TBC219012	2687	2687	2687	2687	2687	2687	2687	2687	2687	2687	2687	2687
TBC249012	2809	2809	2809	2809	2809	2809	2809	2809	2809	2809	2809	2809
TBC279012	2960	2960	2960	2960	2960	2960	2960	2960	2960	2960	2960	2960
TBC309012	3110	3110	3110	3110	3110	3110	3110	3110	3110	3110	3110	3110
TBC339012	3204	3204	3204	3204	3204	3204	3204	3204	3204	3204	3204	3204
TBC369012	3298	3298	3298	3298	3298	3298	3298	3298	3298	3298	3298	3298

TBC219018	3220	3220	3220	3220	3220	3220	3220	3220	3220	3220	3220	3220
TBC249018	3367	3367	3367	3367	3367	3367	3367	3367	3367	3367	3367	3367
TBC279018	3551	3551	3551	3551	3551	3551	3551	3551	3551	3551	3551	3551
TBC309018	3734	3734	3734	3734	3734	3734	3734	3734	3734	3734	3734	3734
TBC339018	3846	3846	3846	3846	3846	3846	3846	3846	3846	3846	3846	3846
TBC369018	3957	3957	3957	3957	3957	3957	3957	3957	3957	3957	3957	3957

**Custom Modifications**

ADDTK	AUTHL AUTHR	CBO	CCO	CFNTO	CFP	CFRMO	CND	DRWSEC	DRWTK	EXBKL EXBKR	EXL EXR	FB	FFDL	FFDR	FPEB	FTK	FTKAV FTKEV	ID	INVRM	ITI	MIP	PFINBTMB	PTOWB	RD	RECTKALL RECTKBK	RECTKL RECTKR	RT	TVRAV TVRFV TVRVV	VTK	WLI
		STD																												

**Construction Upgrades**

APC	PE
-----	----

**Door Options**

DPSRR
-------



**TALL BOOKCASE, 93" or 96" HIGH, 12" or 18" DEEP**

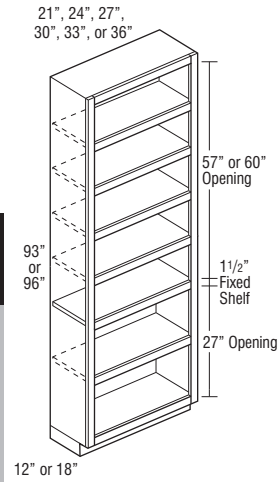

430

OFFICE & FURNITURE CABINETS

Model	1	2	3	4	5	6
<b>NEW</b> TBC219312	2771	2771	2771	2771	2771	2771
TBC249312	2897	2897	2897	2897	2897	2897
<b>NEW</b> TBC279312	3053	3053	3053	3053	3053	3053
TBC309312	3208	3208	3208	3208	3208	3208
<b>NEW</b> TBC339312	3306	3306	3306	3306	3306	3306
TBC369312	3403	3403	3403	3403	3403	3403
<b>NEW</b> TBC219318	3321	3321	3321	3321	3321	3321
TBC249318	3474	3474	3474	3474	3474	3474
<b>NEW</b> TBC279318	3664	3664	3664	3664	3664	3664
TBC309318	3854	3854	3854	3854	3854	3854
<b>NEW</b> TBC339318	3970	3970	3970	3970	3970	3970
TBC369318	4085	4085	4085	4085	4085	4085
<b>NEW</b> TBC219612	2771	2771	2771	2771	2771	2771
TBC249612	2897	2897	2897	2897	2897	2897
<b>NEW</b> TBC279612	3053	3053	3053	3053	3053	3053
TBC309612	3208	3208	3208	3208	3208	3208
<b>NEW</b> TBC339612	3306	3306	3306	3306	3306	3306
TBC369612	3403	3403	3403	3403	3403	3403
<b>NEW</b> TBC219618	3321	3321	3321	3321	3321	3321
TBC249618	3474	3474	3474	3474	3474	3474
<b>NEW</b> TBC279618	3664	3664	3664	3664	3664	3664
TBC309618	3854	3854	3854	3854	3854	3854
<b>NEW</b> TBC339618	3970	3970	3970	3970	3970	3970
TBC369618	4085	4085	4085	4085	4085	4085

- 93" tall includes five adjustable shelves and one fixed shelf.
- 96" tall includes six adjustable shelves and one fixed shelf.
- Separate pedestal base included but packaged separately on 93" and 96" tall. Pedestals are the same width as the cabinet box except when specified with FPFB, in which the pedestal will be 1/4" recessed when centered.
- Matching Interior Plywood (MIP) standard.
- Face frame has a profiled inside edge.
- If ordered with Heirloom Technique, will not feature sand-through characteristics.
- To change the top rail valance, specify one of the following modifications: Arch (TVRAV), Furniture (TVRFV), or Straight Valance (TVRVV).
- Bookcases can only be reduced to 9".

Model	7	8	9	10	11	12	13	14	15	16	17	18
TBC219312	2771	2771	2771	2771	2771	2771	2771	2771	2771	2771	2771	2771
TBC249312	2897	2897	2897	2897	2897	2897	2897	2897	2897	2897	2897	2897
TBC279312	3053	3053	3053	3053	3053	3053	3053	3053	3053	3053	3053	3053
TBC309312	3208	3208	3208	3208	3208	3208	3208	3208	3208	3208	3208	3208
TBC339312	3306	3306	3306	3306	3306	3306	3306	3306	3306	3306	3306	3306
TBC369312	3403	3403	3403	3403	3403	3403	3403	3403	3403	3403	3403	3403
TBC219318	3321	3321	3321	3321	3321	3321	3321	3321	3321	3321	3321	3321
TBC249318	3474	3474	3474	3474	3474	3474	3474	3474	3474	3474	3474	3474
TBC279318	3664	3664	3664	3664	3664	3664	3664	3664	3664	3664	3664	3664
TBC309318	3854	3854	3854	3854	3854	3854	3854	3854	3854	3854	3854	3854
TBC339318	3970	3970	3970	3970	3970	3970	3970	3970	3970	3970	3970	3970
TBC369318	4085	4085	4085	4085	4085	4085	4085	4085	4085	4085	4085	4085
TBC219612	2771	2771	2771	2771	2771	2771	2771	2771	2771	2771	2771	2771
TBC249612	2897	2897	2897	2897	2897	2897	2897	2897	2897	2897	2897	2897
TBC279612	3053	3053	3053	3053	3053	3053	3053	3053	3053	3053	3053	3053
TBC309612	3208	3208	3208	3208	3208	3208	3208	3208	3208	3208	3208	3208
TBC339612	3306	3306	3306	3306	3306	3306	3306	3306	3306	3306	3306	3306
TBC369612	3403	3403	3403	3403	3403	3403	3403	3403	3403	3403	3403	3403
TBC219618	3321	3321	3321	3321	3321	3321	3321	3321	3321	3321	3321	3321
TBC249618	3474	3474	3474	3474	3474	3474	3474	3474	3474	3474	3474	3474
TBC279618	3664	3664	3664	3664	3664	3664	3664	3664	3664	3664	3664	3664
TBC309618	3854	3854	3854	3854	3854	3854	3854	3854	3854	3854	3854	3854
TBC339618	3970	3970	3970	3970	3970	3970	3970	3970	3970	3970	3970	3970
TBC369618	4085	4085	4085	4085	4085	4085	4085	4085	4085	4085	4085	4085

**Custom Modifications**

ADDTK	AUTHL AUTHR	CBO	CCO	CFNTO	CFP	CFRMO	CND	DRWSEC	DRWTK	EXBKL EXBKR	EXL EXR	FB	FFDL FFDR	FPFB	FTK	FTKAV FTKFV	ID	INFRM	LTI	MIP	PFINBTMB	PTOWB	RD	RECTKALL RECTKBK	RECTKL RECTKR	RT	TVRAV TVRFV TVRVV	VTK	WLI

**Construction Upgrades**

APC	PE
-----	----

**Door Options**

DPSRR
-------

431

OFFICE & FURNITURE CABINETS

**TALL BOOKCASE with DOORS, 84", 87", or 90" HIGH, 12" or 18" DEEP**

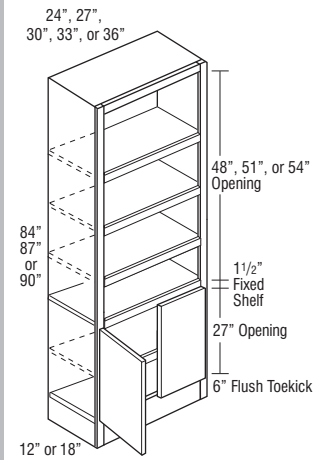
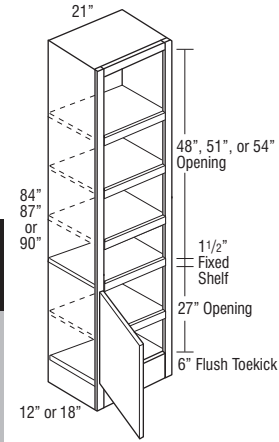

Model	1	2	3	4	5	6
<b>NEW</b> TBCD218412 L or R	2984	3001	3034	3078	3092	3044
TBCD248412	3101	3119	3153	3199	3213	3163
<b>NEW</b> TBCD278412	3166	3184	3222	3270	3284	3333
TBCD308412	3231	3249	3290	3341	3354	3503
<b>NEW</b> TBCD338412	3308	3323	3364	3415	3428	3572
TBCD368412	3384	3397	3437	3488	3501	3640
<b>NEW</b> TBCD218418 L or R	3493	3513	3551	3603	3619	3563
TBCD248418	3639	3653	3691	3738	3752	3703
<b>NEW</b> TBCD278418	3733	3748	3789	3838	3851	3904
TBCD308418	3827	3842	3887	3937	3950	4104
<b>NEW</b> TBCD338418	3919	3936	3979	4029	4041	4193
TBCD368418	4010	4030	4070	4120	4132	4281
<b>NEW</b> TBCD218712 L or R	3037	3054	3088	3133	3146	3097
TBCD248712	3154	3173	3208	3255	3270	3219
<b>NEW</b> TBCD278712	3222	3239	3277	3327	3342	3392
TBCD308712	3290	3305	3346	3399	3413	3564
<b>NEW</b> TBCD338712	3367	3381	3422	3475	3487	3634
TBCD368712	3443	3456	3498	3550	3561	3703
<b>NEW</b> TBCD218718 L or R	3553	3573	3612	3665	3681	3624
TBCD248718	3702	3717	3756	3804	3816	3769
<b>NEW</b> TBCD278718	3798	3814	3855	3905	3918	3973
TBCD308718	3893	3911	3954	4006	4020	4177
<b>NEW</b> TBCD338718	3988	4006	4048	4099	4113	4267
TBCD368718	4082	4101	4142	4191	4205	4357
<b>NEW</b> TBCD219012 L or R	3088	3106	3140	3186	3200	3150
TBCD249012	3208	3227	3263	3310	3326	3274
<b>NEW</b> TBCD279012	3277	3294	3333	3384	3400	3450
TBCD309012	3346	3360	3402	3457	3473	3626
<b>NEW</b> TBCD339012	3424	3437	3480	3533	3549	3697
TBCD369012	3502	3514	3557	3609	3624	3767
<b>NEW</b> TBCD219018 L or R	3614	3635	3675	3728	3745	3686
TBCD249018	3766	3782	3821	3868	3882	3835
<b>NEW</b> TBCD279018	3863	3881	3922	3971	3986	4041
TBCD309018	3959	3979	4023	4073	4089	4247
<b>NEW</b> TBCD339018	4056	4075	4118	4170	4183	4339
TBCD369018	4153	4170	4213	4266	4276	4431

- 84" and 87" tall include four adjustable shelves and one fixed shelf.
- 90" tall includes five adjustable shelves and one fixed shelf.
- Matching Interior Plywood (MIP) standard.
- Face frame has a profiled inside edge.
- Top of doors match to a standard, full height base door, 34 1/2" high.
- To change the top rail valance, specify one of the following modifications: Arch (TVRAV), Furniture (TVRFV), or Straight Valance (TVRVV).
- Bookcases can only be reduced to 9".

Model	7	8	9	10	11	12	13	14	15	16	17	18
TBCD218412 L or R	3386	3225	3291	3421	3453	3519	3612	3468	3612	3552	3698	3845
TBCD248412	3519	3351	3420	3555	3588	3657	3754	3604	3754	3691	3843	3996
TBCD278412	3597	3532	3603	3747	3782	3854	3945	3788	3945	3879	4038	4199
TBCD308412	3675	3713	3786	3939	3975	4051	4136	3972	4136	4066	4233	4402
TBCD338412	3757	3787	3862	4017	4053	4132	4210	4042	4210	4131	4302	4474
TBCD368412	3838	3860	3937	4094	4130	4212	4284	4112	4284	4195	4370	4545

<b>NEW</b> TBCD218418 L or R	3964	3774	3852	4004	4041	4119	4228	4059	4228	4157	4328	4501
TBCD248418	4111	3930	4006	4169	4204	4287	4382	4205	4382	4288	4469	4647
<b>NEW</b> TBCD278418	4221	4141	4222	4393	4431	4518	4604	4420	4604	4508	4697	4885
TBCD308418	4331	4352	4438	4616	4657	4748	4826	4635	4826	4728	4924	5122
<b>NEW</b> TBCD338418	4432	4444	4531	4714	4756	4850	4921	4726	4921	4813	5013	5214
TBCD368418	4532	4535	4624	4812	4854	4951	5016	4817	5016	4898	5101	5306

<b>NEW</b> TBCD218712 L or R	3446	3281	3349	3481	3514	3581	3676	3529	3676	3614	3763	3913
TBCD248712	3582	3409	3480	3618	3651	3723	3819	3667	3819	3756	3912	4068
<b>NEW</b> TBCD278712	3661	3594	3667	3814	3848	3923	4015	3855	4015	3947	4110	4274
TBCD308712	3739	3778	3854	4009	4044	4122	4211	4042	4211	4137	4308	4479
<b>NEW</b> TBCD338712	3822	3853	3930	4088	4124	4203	4286	4113	4286	4203	4377	4552
TBCD368712	3905	3928	4006	4166	4203	4283	4360	4184	4360	4269	4446	4624

<b>NEW</b> TBCD218718 L or R	4031	3839	3918	4073	4110	4190	4301	4129	4301	4228	4403	4578
TBCD248718	4183	4001	4075	4241	4276	4363	4459	4278	4459	4364	4547	4729
<b>NEW</b> TBCD278718	4296	4215	4296	4469	4508	4598	4685	4498	4685	4587	4779	4970
TBCD308718	4408	4428	4516	4696	4739	4832	4910	4717	4910	4809	5010	5210
<b>NEW</b> TBCD338718	4511	4522	4611	4797	4840	4935	5008	4809	5008	4897	5102	5305
TBCD368718	4614	4616	4705	4897	4940	5038	5105	4901	5105	4984	5193	5400

<b>NEW</b> TBCD219012 L or R	3505	3337	3406	3540	3573	3642	3739	3589	3739	3676	3827	3980
TBCD249012	3642	3469	3539	3683	3712	3786	3886	3732	3886	3821	3980	4138
<b>NEW</b> TBCD279012	3723	3656	3730	3881	3913	3990	4084	3921	4084	4015	4182	4349
TBCD309012	3803	3843	3920	4078	4113	4194	4281	4110	4281	4209	4383	4559
<b>NEW</b> TBCD339012	3888	3919	3997	4158	4194	4276	4358	4184	4358	4275	4453	4631
TBCD369012	3972	3994	4073	4237	4274	4358	4434	4257	4434	4341	4523	4703

<b>NEW</b> TBCD219018 L or R	4101	3906	3986	4143	4182	4262	4375	4200	4375	4302	4479	4657
TBCD249018	4257	4068	4146	4315	4350	4438	4533	4352	4533	4439	4623	4808
<b>NEW</b> TBCD279018	4369	4287	4370	4546	4586	4677	4764	4575	4764	4667	4860	5055
TBCD309018	4481	4505	4593	4777	4821	4916	4995	4797	4995	4894	5096	5301
<b>NEW</b> TBCD339018	4586	4600	4690	4879	4923	5021	5095	4891	5095	4982	5189	5397
TBCD369018	4691	4694	4787	4980	5025	5125	5194	4984	5194	5070	5282	5492

**Custom Modifications**

ADDTK	AUTHL AUTHR	CBO	CCO	CFNTO	CFP	CFRMO	CND	DRWSEC	DRWTK	EXBKL EXBKR	EXL EXR	FB	FFDL FFDR	FPFB	FTK	FTKAV FTKEV	ID	INVRM	LTI	MIP	PFINBTMB	PTOWB	RD	RECTKALL RECTKKBK	RECTKL RECTKR	RT	TVRAV TVRFV TVRVV	VTK	WLI
		•	•	•		•				•	•			•	STD	•	•			STD			•				•		

**Construction Upgrades**

APC	PE
-----	----

**Door Options**

DPSRR
-------

**TALL BOOKCASE with DOORS, 93" or 96" HIGH, 12" or 18" DEEP**

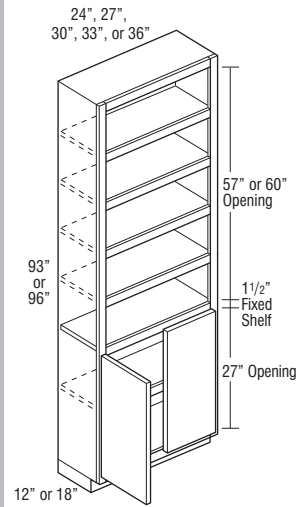
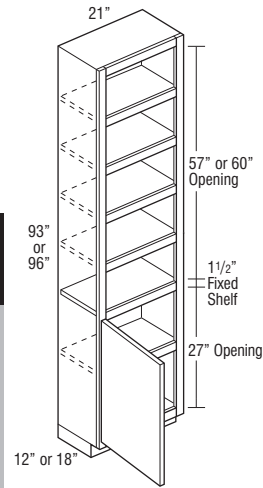

Model	1	2	3	4	5	6
<b>NEW</b> TBCD219312 L or R	3185	3204	3239	3286	3300	3249
TBCD249312	3310	3332	3368	3418	3432	3377
<b>NEW</b> TBCD279312	3381	3401	3440	3493	3508	3559
TBCD309312	3451	3469	3511	3567	3584	3741
<b>NEW</b> TBCD339312	3531	3549	3592	3647	3662	3814
TBCD369312	3610	3628	3672	3726	3739	3887
<hr/>						
<b>NEW</b> TBCD219318 L or R	3729	3751	3792	3847	3864	3804
TBCD249318	3886	3901	3942	3991	4007	3956
<b>NEW</b> TBCD279318	3987	4003	4047	4098	4113	4171
TBCD309318	4088	4104	4152	4205	4219	4385
<b>NEW</b> TBCD339318	4186	4204	4249	4302	4316	4478
TBCD369318	4284	4304	4345	4399	4413	4571
<hr/>						
<b>NEW</b> TBCD219612 L or R	3185	3204	3239	3286	3300	3249
TBCD249612	3310	3332	3368	3418	3432	3377
<b>NEW</b> TBCD279612	3381	3401	3440	3493	3508	3559
TBCD309612	3451	3469	3511	3567	3584	3741
<b>NEW</b> TBCD339612	3531	3549	3592	3647	3662	3814
TBCD369612	3610	3628	3672	3726	3739	3887
<hr/>						
<b>NEW</b> TBCD219618 L or R	3729	3751	3792	3847	3864	3804
TBCD249618	3886	3901	3942	3991	4007	3956
<b>NEW</b> TBCD279618	3987	4003	4047	4098	4113	4171
TBCD309618	4088	4104	4152	4205	4219	4385
<b>NEW</b> TBCD339618	4186	4204	4249	4302	4316	4478
TBCD369618	4284	4304	4345	4399	4413	4571

- 93" tall includes five adjustable shelves and one fixed shelf.
- 96" tall includes six adjustable shelves and one fixed shelf.
- Separate pedestal base included but packaged separately on 93" and 96" tall. Pedestals are the same width as the cabinet box except when specified with FPEB, in which the pedestal will be 1/4" recessed when centered.
- Matching Interior Plywood (MIP) standard.
- Face frame has a profiled inside edge.
- Top of doors match to a standard, full height base door, 34 1/2" high.
- To change the top rail valance, specify one of the following modifications: Arch (TVRAV), Furniture (TVRFV), or Straight Valance (TVRVV).
- Bookcases can only be reduced to 9".

Model	7	8	9	10	11	12	13	14	15	16	17	18
TBCD219312 L or R	3615	3442	3513	3652	3686	3756	3856	3702	3856	3791	3948	4105
TBCD249312	3759	3581	3651	3799	3832	3907	4009	3851	4009	3942	4106	4270
TBCD279312	3842	3775	3848	4004	4038	4117	4214	4046	4214	4142	4314	4486
TBCD309312	3924	3968	4045	4209	4244	4327	4419	4241	4419	4341	4521	4702
TBCD339312	4011	4046	4125	4291	4328	4413	4497	4316	4497	4410	4594	4778
TBCD369312	4098	4124	4205	4372	4411	4498	4575	4391	4575	4479	4666	4853

TBCD219318 L or R	4232	4030	4113	4275	4315	4398	4515	4334	4515	4439	4622	4806
TBCD249318	4390	4197	4278	4451	4488	4578	4679	4489	4679	4580	4773	4964
TBCD279318	4507	4422	4509	4690	4731	4826	4917	4720	4917	4815	5016	5217
TBCD309318	4624	4647	4739	4928	4974	5073	5154	4950	5154	5049	5259	5469
TBCD339318	4733	4746	4840	5034	5080	5181	5256	5047	5256	5140	5354	5568
TBCD369318	4841	4845	4940	5139	5185	5288	5357	5144	5357	5231	5448	5666

TBCD219612 L or R	3615	3442	3513	3652	3686	3756	3856	3702	3856	3791	3948	4105
TBCD249612	3759	3581	3651	3799	3832	3907	4009	3851	4009	3942	4106	4270
TBCD279612	3842	3775	3848	4004	4038	4117	4214	4046	4214	4142	4314	4486
TBCD309612	3924	3968	4045	4209	4244	4327	4419	4241	4419	4341	4521	4702
TBCD339612	4011	4046	4125	4291	4328	4413	4497	4316	4497	4410	4594	4778
TBCD369612	4098	4124	4205	4372	4411	4498	4575	4391	4575	4479	4666	4853

TBCD219618 L or R	4232	4030	4113	4275	4315	4398	4515	4334	4515	4439	4622	4806
TBCD249618	4390	4197	4278	4451	4488	4578	4679	4489	4679	4580	4773	4964
TBCD279618	4507	4422	4509	4690	4731	4826	4917	4720	4917	4815	5016	5217
TBCD309618	4624	4647	4739	4928	4974	5073	5154	4950	5154	5049	5259	5469
TBCD339618	4733	4746	4840	5034	5080	5181	5256	5047	5256	5140	5354	5568
TBCD369618	4841	4845	4940	5139	5185	5288	5357	5144	5357	5231	5448	5666

**Custom Modifications**

ADDTK	AUTHL AUTHR	CBO	CCO	CFNTO	CFP	CFRMO	CND	DRWSEC	DRWTK	EXBKL EXBKR	EXL EXR	FB	FFDL	FFDR	FPEB	FTK	FTKAV	FTKFV	ID	INVRM	LTI	MIP	PFINBTMB	PTOWB	RD	RECTKALL	RECTKLBK	RECTKL	RECTKR	RT	TVRAV	TVRFV	TVRVV	VTK	WLI
		•	•	•		•				•	•				•				•			STD			•						•				

**Construction Upgrades**

APC	PE
-----	----

**Door Options**

DPSRR
•

**DESK DOOR DRAWER BASE,  
29" HIGH, 21" or 24" DEEP**

12", 15", 18", or 21"

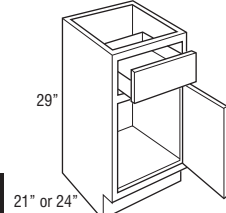

DDO122921 L or R    DDO122924 L or R  
DDO152921 L or R    DDO152924 L or R  
DDO182921 L or R    DDO182924 L or R  
DDO212921 L or R    DDO212924 L or R

24", 27", 30", 33", or 36"

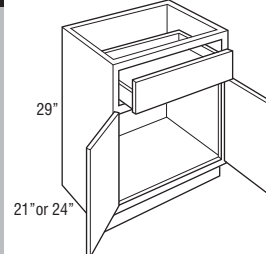

DDO242921    DDO242924  
DDO272921    DDO272924  
DDO302921    DDO302924  
DDO332921    DDO332924  
DDO362921    DDO362924

Model	1	2	3	4	5	6
DDO122921 L or R	617	649	693	740	740	740
DDO152921 L or R	657	687	728	794	793	794
DDO182921 L or R	678	709	751	824	822	824
DDO212921 L or R	702	734	773	857	853	857
DDO122924 L or R	629	663	708	761	761	761
DDO152924 L or R	670	703	743	817	815	817
DDO182924 L or R	691	727	767	845	842	845
DDO212924 L or R	716	750	792	881	874	881

DDO242921	813	845	892	939	939	939
DDO272921	872	910	961	1020	1020	1020
DDO302921	930	972	1029	1101	1101	1101
DDO332921	1035	1083	1146	1245	1245	1245
DDO362921	1138	1192	1264	1388	1388	1388
DDO242924	828	865	913	965	965	965
DDO272924	888	928	980	1049	1049	1049
DDO302924	950	991	1048	1133	1133	1133
DDO332924	1058	1105	1169	1280	1280	1280
DDO362924	1165	1218	1290	1426	1426	1426

- Depth can be reduced to a minimum of 12".
- Depth can be increased to a maximum of 24".

Model	7	8	9	10	11	12	13	14	15	16	17	18
DDO122921 L or R	815	782	793	821	831	843	874	877	911	934	968	1008
DDO152921 L or R	874	837	853	883	889	909	939	943	980	1005	1042	1084
DDO182921 L or R	909	869	884	917	923	939	972	980	1016	1041	1081	1124
DDO212921 L or R	940	906	919	956	961	979	1014	1018	1057	1085	1125	1170
DDO122924 L or R	836	801	814	843	852	867	896	903	934	960	994	1036
DDO152924 L or R	897	861	874	909	914	929	964	967	1006	1029	1068	1111
DDO182924 L or R	931	892	911	944	950	965	999	1008	1046	1069	1111	1154
DDO212924 L or R	970	927	946	980	987	1005	1041	1047	1087	1113	1155	1201

DDO242921	1035	992	1010	1046	1053	1076	1113	1117	1162	1189	1233	1285
DDO272921	1124	1078	1098	1137	1146	1169	1210	1215	1264	1295	1343	1398
DDO302921	1214	1165	1186	1227	1239	1262	1306	1313	1366	1398	1452	1511
DDO332921	1370	1315	1341	1389	1399	1427	1477	1484	1546	1583	1644	1710
DDO362921	1524	1465	1494	1548	1559	1593	1649	1656	1724	1767	1836	1909
DDO242924	1060	1018	1038	1076	1085	1102	1144	1146	1192	1223	1270	1321
DDO272924	1154	1108	1128	1169	1179	1200	1245	1248	1297	1331	1382	1438
DDO302924	1247	1197	1218	1262	1274	1297	1345	1348	1400	1439	1495	1554
DDO332924	1407	1351	1377	1427	1441	1467	1521	1524	1585	1627	1692	1759
DDO362924	1567	1506	1537	1593	1606	1636	1698	1702	1769	1816	1889	1964

**Custom Modifications**

ADDTK	AUTHL AUTHR	CBO	CCO	CFNTD	CFP	CFRMO	CND	DRWSEC	DRWTK	EXBKL EXBKR	EXL EXR	FB	FFDL FFDR	FPEB	FTK	FTKAV FTKFV	ID	INVRM	LTI	MIP	PFINBTMB	PTOWB	RD	RECTKALL RECTKBK	RECTKL RECTKR	RT	TVRV TVRFV TVRVV	VTK	WLI
	•*	•	•	•	•	•	•	•	•	•	•	•	•	•	•	• <sup>i</sup>	• <sup>i</sup>	•	•	•	•	•	•	•	•	•	•	•	•

\*Not available on 21" deep    \*Available only on 18", 21", and 24" wide    †Not available on 12" and 15" wide    †Not available on 12" wide    †Not available on 24" deep

**Construction Upgrades**

APC	PE
•	•

**Door Options**

DPSRR
•

**DESK THREE DRAWER BASE,  
29" HIGH, 21" or 24" DEEP**

12", 15", 18", 21",  
24", 27", 30", 33", or 36"

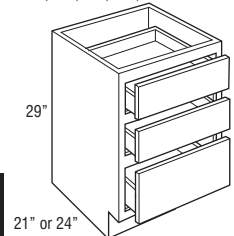

438

Model	1	2	3	4	5	6
3DB122921	1201	1201	1201	1201	1201	1201
3DB152921	1260	1260	1260	1260	1260	1260
3DB182921	1309	1309	1309	1309	1314	1314
3DB212921	1340	1340	1340	1340	1366	1366
3DB122924	1228	1228	1228	1228	1228	1228
3DB152924	1289	1289	1289	1289	1289	1289
3DB182924	1329	1329	1329	1329	1345	1345
3DB212924	1364	1364	1364	1364	1398	1398
3DB242921	1372	1372	1372	1372	1420	1420
3DB272921	1481	1481	1481	1481	1534	1534
3DB302921	1601	1601	1601	1601	1656	1656
3DB332921	1729	1729	1729	1729	1789	1789
3DB362921	1868	1868	1868	1868	1931	1931
3DB242924	1395	1395	1395	1395	1454	1454
3DB272924	1506	1506	1506	1506	1571	1571
3DB302924	1626	1626	1626	1626	1697	1697
3DB332924	1756	1756	1756	1756	1833	1833
3DB362924	1897	1897	1897	1897	1979	1979

- Depth can be reduced to a minimum of 12".
- Depth can be increased to a maximum of 24".

Model	7	8	9	10	11	12	13	14	15	16	17	18
3DB122921	1321	1256	1277	1317	1328	1347	1392	1396	1445	1476	1525	1589
3DB152921	1388	1320	1341	1387	1394	1416	1461	1470	1519	1551	1604	1668
3DB182921	1441	1376	1397	1445	1452	1478	1525	1535	1588	1622	1679	1745
3DB212921	1473	1432	1456	1504	1515	1541	1593	1598	1654	1690	1749	1819
3DB122924	1351	1287	1310	1349	1357	1385	1428	1432	1481	1514	1566	1631
3DB152924	1419	1349	1374	1418	1428	1450	1499	1503	1553	1594	1647	1712
3DB182924	1461	1407	1432	1480	1491	1516	1566	1573	1627	1662	1724	1794
3DB212924	1501	1467	1491	1541	1551	1579	1633	1638	1694	1736	1797	1868
3DB242921	1508	1489	1514	1563	1576	1601	1655	1659	1719	1757	1825	1897
3DB272921	1628	1606	1635	1687	1703	1729	1787	1793	1856	1898	1971	2049
3DB302921	1758	1735	1766	1824	1838	1868	1930	1935	2005	2051	2128	2214
3DB332921	1899	1874	1908	1970	1985	2016	2085	2089	2165	2215	2298	2390
3DB362921	2052	2024	2060	2127	2144	2179	2251	2256	2338	2391	2481	2583
3DB242924	1537	1525	1550	1602	1613	1640	1697	1703	1762	1802	1865	1941
3DB272924	1658	1649	1674	1731	1743	1771	1833	1838	1902	1947	2014	2097
3DB302924	1792	1781	1807	1869	1882	1913	1979	1985	2055	2101	2177	2265
3DB332924	1933	1924	1953	2019	2033	2065	2138	2144	2219	2269	2351	2445
3DB362924	2088	2078	2109	2180	2193	2232	2308	2316	2396	2451	2539	2642

**Custom Modifications**

ADDTK	AUTHL AUTHR	CBO	CCO	CFNTD	CFP	CFRMO	CND	DRWSEC	DRWTK	EXBKL EXBKR	EXL EXR	FB	FFDL FFDR	FPEB	FTK	FTKAV FTKRV	ID	INVRM	LTI	MIP	PFINBTMB	PTOWB	RD	RECTKALL RECTKBK	RECTKL RECTKR	RT	TVRAV TVRFV TVRVV	VTK	WLI
	•*	•	•		•	•		•	•	•	•	•	•	•	•	•	•				•		•	•	•		•		

\*Not available on 21" deep    \*Available only on 18", 21", and 24" wide, 24" deep    \*Not available on 12" and 15" wide    †Not available on 12" wide

**Construction Upgrades**

APC	PE
•	•

**Door Options**

DPSRR

439

**DESK FILE DRAWER BASE, 29" HIGH, 21" or 24" DEEP**

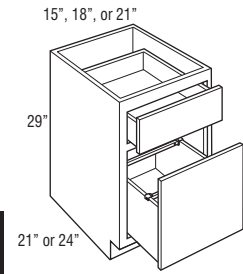

Model	1	2	3	4	5	6
<b>DFD152921</b>	1153	1168	1186	1232	1232	1232
<b>DFD182921</b>	1237	1256	1275	1349	1349	1349
<b>DFD212921</b>	1324	1344	1367	1467	1467	1467
<hr/>						
<b>DFD152924</b>	1172	1192	1212	1264	1264	1264
<b>DFD182924</b>	1262	1284	1303	1387	1387	1387
<b>DFD212924</b>	1349	1375	1394	1506	1506	1506

- Door is attached to file drawer.
- Includes Filing System Hardware Kit, which accommodates letter and legal filing.
- Exterior height of file drawer is 10".

**DESK DOUBLE FILE DRAWER BASE, 29" HIGH, 21" or 24" DEEP**

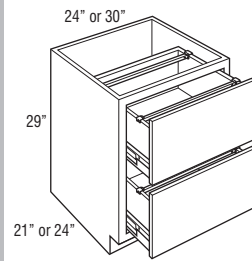

<b>DDFD242921</b>	1251	1278	1306	1461	1457	1704
<b>DDFD302921</b>	1381	1408	1443	1610	1607	1883
<hr/>						
<b>DDFD242924</b>	1286	1317	1345	1504	1504	1754
<b>DDFD302924</b>	1420	1453	1484	1659	1659	1939

- Includes Filing System Hardware Kit, which accommodates letter and legal filing.
- Drawers utilize 125 lb. full extension progressive side-mount guide, does not feature soft-close guide.
- Bottom of drawer is not designed to support any weight.
- Exterior height of drawer box is 9 1/2".

**DESK WASTEBASKET FULL HEIGHT BASE, 29" HIGH, 15" or 18" WIDE, 21" or 24" DEEP**

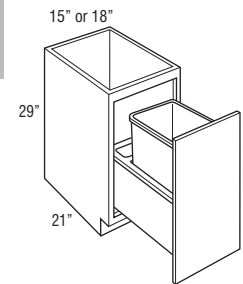

<b>DWB152921FH</b>	1255	1287	1327	1393	1392	1393
<b>DWB182921FH</b>	1278	1308	1348	1422	1420	1422
<hr/>						
<b>DWB152924FH</b>	1270	1302	1342	1414	1413	1414
<b>DWB182924FH</b>	1302	1338	1377	1455	1452	1455

- Pull-out features undermount Smart Stop guides.
- DWB152921FH, DWB182921FH, and DWB152924FH include one 35 quart gray wastebasket and a trash bag storage area.
- DWB182924FH includes two 35 quart gray wastebaskets.
- Base Wastebasket Lid (BWBLID) fits 35 quart wastebaskets. On DWB182924FH, BWBLID can only be used on the front wastebasket. See page 579.

DWB152921FH  
DWB182921FH

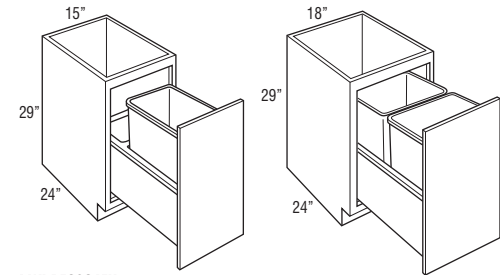

DWB152924FH

DWB182924FH

Model	7	8	9	10	11	12	13	14	15	16	17	18
<b>DFD152921</b>	1355	1296	1319	1364	1375	1398	1448	1453	1506	1545	1601	1665
<b>DFD182921</b>	1487	1421	1447	1496	1507	1537	1590	1597	1655	1696	1757	1831
<b>DFD212921</b>	1614	1546	1574	1628	1641	1670	1731	1739	1802	1849	1917	1995
<hr/>												
<b>DFD152924</b>	1391	1329	1351	1398	1407	1435	1482	1492	1547	1583	1641	1707
<b>DFD182924</b>	1523	1456	1484	1537	1547	1574	1628	1638	1698	1741	1804	1875
<b>DFD212924</b>	1657	1584	1614	1670	1684	1712	1776	1784	1851	1897	1966	2046

**Custom Modifications**

ADDTK	AUTHL AUTHR	CBO	CCO	CFNTO	CFP	CFRMO	CND	DRWSEC	DRWTK	EXBKL EXBKR	EXL EXR	FB	FFDL FFDR	FPEB	FTK	FTKAV FTKFV	ID	INVFRM	LTI	MIP	PFINBTMB	PTOWB	RD	RECTKALL RECTKBK	RECTKL RECTKR	RT	TVRAV TVRFV TVRVV	VTK	WLI
	•*	•	•					•	•*	•*	•	•	•	•	•	•					•			•	•			•	

\*Not available on 21" deep \*Available only on 18" and 21" wide, 24" deep \*Not available on 15" wide

**Construction Upgrades**

APC	PE
•	•

**Door Options**

DPSRR
-------

<b>DDFD242921</b>	1606	1806	1844	1915	1932	1973	2049	2060	2146	2206	2299	2389
<b>DDFD302921</b>	1773	1994	2036	2116	2132	2178	2262	2274	2367	2434	2536	2638
<hr/>												
<b>DDFD242924</b>	1655	1858	1899	1973	1989	2029	2108	2123	2209	2269	2362	2460
<b>DDFD302924</b>	1826	2051	2095	2178	2196	2240	2328	2339	2437	2505	2608	2712

**Custom Modifications**

ADDTK	AUTHL AUTHR	CBO	CCO	CFNTO	CFP	CFRMO	CND	DRWSEC	DRWTK	EXBKL EXBKR	EXL EXR	FB	FFDL FFDR	FPEB	FTK	FTKAV FTKFV	ID	INVFRM	LTI	MIP	PFINBTMB	PTOWB	RD	RECTKALL RECTKBK	RECTKL RECTKR	RT	TVRAV TVRFV TVRVV	VTK	WLI
	•*	•	•					•	•	•	•	•	•	•	•	•					•			•	•			•	

\*Not available on 21" deep

**Construction Upgrades**

APC	PE
•	•

**Door Options**

DPSRR
-------

<b>DWB152921FH</b>	1471	1435	1449	1479	1487	1503	1537	1540	1574	1597	1635	1676
<b>DWB182921FH</b>	1503	1464	1480	1511	1518	1537	1566	1574	1607	1634	1673	1715
<hr/>												
<b>DWB152924FH</b>	1494	1455	1471	1503	1508	1523	1557	1560	1598	1622	1659	1700
<b>DWB182924FH</b>	1540	1501	1516	1551	1556	1571	1604	1610	1650	1673	1712	1755

**Custom Modifications**

ADDTK	AUTHL AUTHR	CBO	CCO	CFNTO	CFP	CFRMO	CND	DRWSEC	DRWTK	EXBKL EXBKR	EXL EXR	FB	FFDL FFDR	FPEB	FTK	FTKAV FTKFV	ID	INVFRM	LTI	MIP	PFINBTMB	PTOWB	RD	RECTKALL RECTKBK	RECTKL RECTKR	RT	TVRAV TVRFV TVRVV	VTK	WLI
	•*	•	•					•	•*	•	•	•	•	•	•	•					•			•	•			•	•

\*Not available on 21" deep \*Not available on 15" wide

**Construction Upgrades**

APC	PE
•	•

**Door Options**

DPSRR
-------



**FURNITURE DRAWER WINDOW BENCH, 18" HIGH, 24" DEEP**

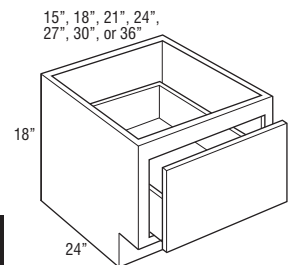

Model	1	2	3	4	5	6
FDWB151824	737	737	737	737	747	773
FDWB181824	776	776	776	776	792	821
FDWB211824	815	815	815	815	835	870
FDWB241824	866	866	866	866	908	908
FDWB271824	914	914	914	914	974	974
FDWB301824	1015	1015	1015	1015	1091	1091
FDWB361824	1101	1101	1101	1101	1216	1216

- Drawer front to face frame reveal is justified to the bottom to be consistent with both full overlay and partial overlay. Partial overlay top reveal is 2 5/8" and bottom reveal is 1". Full overlay top reveal is 1 7/8" and bottom reveal is 1/4".
- Exterior height of drawer box is 6 3/8".

Model	7	8	9	10	11	12	13	14	15	16	17	18
FDWB151824	793	806	815	837	842	856	878	880	909	925	957	987
FDWB181824	834	856	867	889	894	911	934	935	965	985	1016	1049
FDWB211824	878	908	920	944	951	965	992	994	1026	1046	1078	1114
FDWB241824	931	944	960	987	992	1007	1036	1040	1072	1093	1128	1165
FDWB271824	985	1019	1037	1069	1076	1093	1128	1136	1171	1201	1239	1279
FDWB301824	1093	1145	1165	1203	1213	1229	1271	1284	1321	1357	1400	1449
FDWB361824	1188	1272	1292	1334	1343	1367	1408	1423	1465	1503	1549	1601

**Custom Modifications**

ADDTK	AUTHL AUTHR	CBO	CCO	CFNTO	CFP	CFRMO	CND	DRWSEC	DRWTK	EXBKL EXBKR	EXL EXR	FB	FFDL	FPEB	FTK	FTKAV	FTKFV	ID	INVFRM	LTI	MIP	PFINBTMB	PTOWB	RD	RECTKALL	RECTKRBK	RECTKL	RECTKR	RT	TVRAV	TVRFV	TVRVV	VTK	WLI
		•	•			•			•*	•	•	•			•	•	•					•		•	•	•						•		

\*Not available on 15" wide

**Construction Upgrades**

APC	PE
•	

**Door Options**

DPSRR

1TWT7221	841	841	841	841	841	841	841	841	841	841	841	841
1TWT7224	956	956	956	956	956	956	956	956	956	956	956	956

**MODIFICATIONS**  
No modifications available for these products.

**Construction Upgrades**

APC	PE
•	

**Finish Techniques**

Distressing	Heirlooming
	•

**WOOD TOPS, ONE SIDED, 22 1/2" or 25 1/2" DEEP**

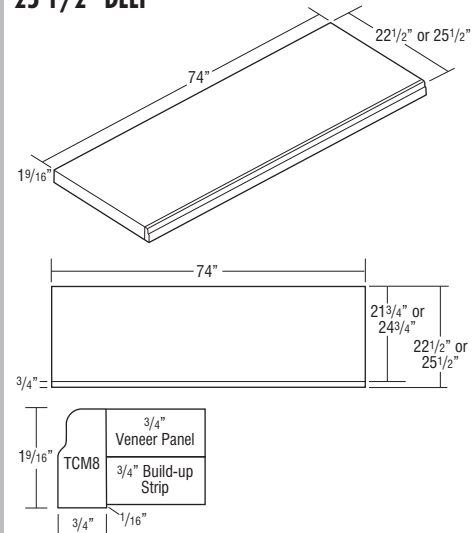

1TWT7221	841	841	841	841	841	841
1TWT7224	956	956	956	956	956	956

- 3/4" thick veneer over MDF panels with build-up strips to 1 1/2" thick and Traditional Countertop Moulding (TCM8) on front edge.

1TWT7221	841	841	841	841	841	841	841	841	841	841	841	841
1TWT7224	956	956	956	956	956	956	956	956	956	956	956	956

**MODIFICATIONS**  
No modifications available for these products.

**Construction Upgrades**

APC	PE
•	

**Finish Techniques**

Distressing	Heirlooming
	•



**WOOD TOPS, THREE SIDED, 22 1/2" or 25 1/2" DEEP**

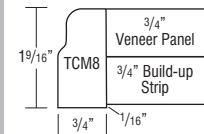
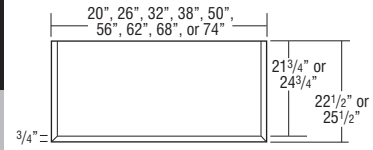
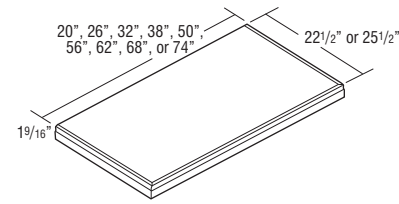

Model	Overall Width	Overall Depth
3TWT1821	20"	22 1/2"
3TWT2421	26"	22 1/2"
3TWT3021	32"	22 1/2"
3TWT3621	38"	22 1/2"
3TWT4821	50"	22 1/2"
3TWT5421	56"	22 1/2"
3TWT6021	62"	22 1/2"
3TWT6621	68"	22 1/2"
3TWT7221	74"	22 1/2"

Model	Overall Width	Overall Depth
3TWT1824	20"	25 1/2"
3TWT2424	26"	25 1/2"
3TWT3024	32"	25 1/2"
3TWT3624	38"	25 1/2"
3TWT4824	50"	25 1/2"
3TWT5424	56"	25 1/2"
3TWT6024	62"	25 1/2"
3TWT6624	68"	25 1/2"
3TWT7224	74"	25 1/2"

Model	1	2	3	4	5	6
3TWT1821	253	253	253	253	253	253
3TWT2421	330	330	330	330	330	330
3TWT3021	405	405	405	405	405	405
3TWT3621	482	482	482	482	482	482
3TWT4821	634	634	634	634	634	634
3TWT5421	709	709	709	709	709	709
3TWT6021	786	786	786	786	786	786
3TWT6621	863	863	863	863	863	863
3TWT7221	937	937	937	937	937	937

3TWT1824	288	288	288	288	288	288
3TWT2424	373	373	373	373	373	373
3TWT3024	459	459	459	459	459	459
3TWT3624	546	546	546	546	546	546
3TWT4824	718	718	718	718	718	718
3TWT5424	806	806	806	806	806	806
3TWT6024	889	889	889	889	889	889
3TWT6624	976	976	976	976	976	976
3TWT7224	1062	1062	1062	1062	1062	1062

• 3/4" thick veneer over MDF panels with build-up strips to 1 1/2" thick and Traditional Countertop Moulding (TCM8) on front and side edges.

Model	7	8	9	10	11	12	13	14	15	16	17	18
3TWT1821	253	253	253	253	253	253	253	253	253	253	253	253
3TWT2421	330	330	330	330	330	330	330	330	330	330	330	330
3TWT3021	405	405	405	405	405	405	405	405	405	405	405	405
3TWT3621	482	482	482	482	482	482	482	482	482	482	482	482
3TWT4821	634	634	634	634	634	634	634	634	634	634	634	634
3TWT5421	709	709	709	709	709	709	709	709	709	709	709	709
3TWT6021	786	786	786	786	786	786	786	786	786	786	786	786
3TWT6621	863	863	863	863	863	863	863	863	863	863	863	863
3TWT7221	937	937	937	937	937	937	937	937	937	937	937	937

3TWT1824	288	288	288	288	288	288	288	288	288	288	288	288
3TWT2424	373	373	373	373	373	373	373	373	373	373	373	373
3TWT3024	459	459	459	459	459	459	459	459	459	459	459	459
3TWT3624	546	546	546	546	546	546	546	546	546	546	546	546
3TWT4824	718	718	718	718	718	718	718	718	718	718	718	718
3TWT5424	806	806	806	806	806	806	806	806	806	806	806	806
3TWT6024	889	889	889	889	889	889	889	889	889	889	889	889
3TWT6624	976	976	976	976	976	976	976	976	976	976	976	976
3TWT7224	1062	1062	1062	1062	1062	1062	1062	1062	1062	1062	1062	1062

**MODIFICATIONS**

No modifications available for these products.

**Construction Upgrades**

APC	PE
•	

**Finish Techniques**

Distressing	Heirlooming
	•



## VANITY CABINET NOMENCLATURE

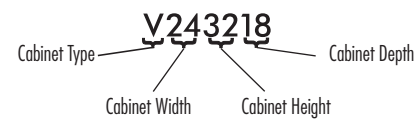

**NOTE:**  
If order is placed in Arch door style, vanity bases will have Square doors and vanity utilities and linen closets will have an Arch top door and Square lower doors.

Distance between back of drawer box and back interior of cabinet is 2 3/4".

All vanity cabinets are predrilled for full depth shelves or roll trays.

## TOEKICKS

Vanity Cabinets are shipped with an unfinished toekick. Finished toekicks in matching wood veneer or laminate must be ordered separately and field installed.

## MODIFICATIONS GRID KEY

- Available
- STD Standard on these cabinets
- S Smart Solutions™ Organization Cabinet
- 5 DAY 5 Day Express Response Item

## CUSTOM MODIFICATIONS

Mod.	Description	Mod.	Description	Mod.	Description
AUTHL	Authentic End - Left	EXBKR	End Extended Back - Right	LTI	Light Installed Battery Strip
AUTHR	Authentic End - Right	EXL	Extended Sisle - Left	MIP	Matching Interior Plywood
CBO	Cabinet Box Only	EXR	Extended Sisle - Right	RD	Reduced Depth
CCO	Cabinet Case Only	FB	Finished Ends	RECTKALL	Recessed Island Toekick
CFNTO	Cabinet Front Only	FFDL	Face Frame and Door on End - Left	RECTKBK	Recessed Toekick - Back
CFP	Cabinet False Panel	FFDR	Face Frame and Door on End - Right	RECTKL	Recessed Toekick - Left
CFRMO	Cabinet Frame Only	FFDR	Face Frame and Door on End - Right	RECTKR	Recessed Toekick - Right
CMAT	CabMat™	FPEB	Furniture Finished Plywood Ends	RT	Installed Roll Tray
CND	Cabinet with No Door, with Drawer	FTK	Flush Toekick	TKP	Loose Toekick
DRWPPWR	PowerGlide™ Compact PowerOutlet	FTKAV	Flush Toekick Arch	TOTSSS	Tilt-out Tray, Stainless Steel Slim
DRWTK	Toekick Drawer	FTKFV	Flush Toekick Furniture	VTK	Void Toekick
EXBKL	End Extended Back - Left	ID	Increased Depth	WLI	White Laminate Interior
		INVFRM	Inverted Frame		

## CONSTRUCTION UPGRADES

Mod.	Description
APC	All-plywood Construction
PE	Plywood Ends

## DOOR OPTIONS

Mod.	Description
ALF	Aluminum Frame Doors
CG	Cut-for-glass Doors
DPSRR	Door Panel - Solid Reverse Raised
MD	Mullion Doors
MFO	Modified Full Overlay

### VANITY BASE, 32" HIGH, 18" or 21" DEEP

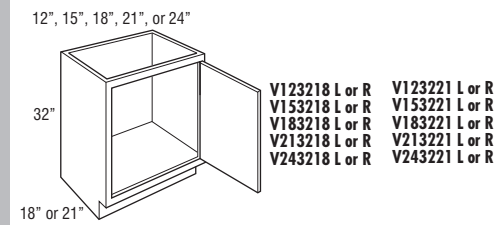

- V123218 L or R
- V153218 L or R
- V183218 L or R
- V213218 L or R
- V243218 L or R
- V123221 L or R
- V153221 L or R
- V183221 L or R
- V213221 L or R
- V243221 L or R

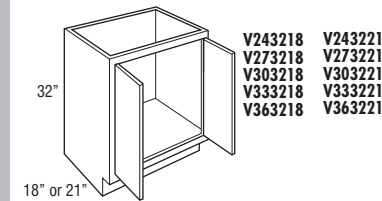

- V243218
- V273218
- V303218
- V333218
- V363218
- V243221
- V273221
- V303221
- V333221
- V363221

Model	1	2	3	4	5	6
V123218 L or R	382	409	461	503	521	550
V153218 L or R	403	430	486	529	548	578
V183218 L or R	424	454	513	556	577	610
V213218 L or R	460	493	557	604	627	662
V243218 L or R	501	534	605	658	680	719
V123221 L or R	382	409	461	503	521	550
V153221 L or R	403	430	486	529	548	578
V183221 L or R	424	454	513	556	577	610
V213221 L or R	460	493	557	604	627	662
V243221 L or R	501	534	605	658	680	719
V243218	527	563	637	691	715	757
V273218	537	575	652	714	756	801
V303218	548	583	666	745	795	836
V333218	578	616	688	779	831	875
V363218	610	649	707	815	867	912
V243221	527	563	637	691	715	757
V273221	537	575	652	714	756	801
V303221	548	583	666	745	795	836
V333221	578	616	688	779	831	875
V363221	610	649	707	815	867	912

Model	7	8	9	10	11	12	13	14	15	16	17	18
V123218 L or R	552	583	594	619	625	635	662	664	695	709	738	767
V153218 L or R	581	615	627	652	659	669	696	700	731	747	778	809
V183218 L or R	613	645	660	686	692	704	733	736	768	786	819	852
V213218 L or R	666	702	716	745	753	765	795	801	835	855	889	925
V243218 L or R	724	763	779	811	818	832	866	870	909	929	967	1007
V123221 L or R	552	583	594	619	625	635	662	664	695	709	738	767
V153221 L or R	581	615	627	652	659	669	696	700	731	747	778	809
V183221 L or R	613	645	660	686	692	704	733	736	768	786	819	852
V213221 L or R	666	702	716	745	753	765	795	801	835	855	889	925
V243221 L or R	724	763	779	811	818	832	866	870	909	929	967	1007
V243218	761	804	820	854	862	875	911	917	957	979	1018	1058
V273218	786	845	866	898	909	925	963	966	1008	1036	1080	1122
V303218	820	885	908	940	951	969	1010	1014	1056	1086	1132	1175
V333218	857	929	947	985	993	1014	1053	1058	1101	1134	1181	1227
V363218	896	965	986	1024	1035	1056	1096	1100	1145	1178	1226	1275
V243221	761	804	820	854	862	875	911	917	957	979	1018	1058
V273221	786	845	866	898	909	925	963	966	1008	1036	1080	1122
V303221	820	885	908	940	951	969	1010	1014	1056	1086	1132	1175
V333221	857	929	947	985	993	1014	1053	1058	1101	1134	1181	1227
V363221	896	965	986	1024	1035	1056	1096	1100	1145	1178	1226	1275

### Custom Modifications

AUTHL	AUTHR	CBO	CCO	CFNTO	CFP	CFRMO	CMAT	CND	DRWPPWR	DRWTK	EXBKL	EXBKR	EXL	EXR	FB	FFDL	FFDR	FPEB	FTK	FTKAV	FTKFV	ID	INVFRM	LTI	MIP	RD	RECTKALL	RECTKBK	RECTKL	RECTKR	RT	TKP	TOTSSS	VTK	WLI
•			•	•		•	•*			•*	•	•	•	•	•	•	•	•	•	•	•	•	•	•	•	•	•	•	•	•	•	•	•	•	•

\*Not available on 12", 15", 18", and 21" wide, or on 18" deep \*Not available on 12" and 15" wide, or on 18" deep \*Not available on 12" wide

### Construction Upgrades

APC	PE
•	•

### Door Options

ALF	CG	DPSRR	MD	MFO
		•		

**VANITY BASE, 32" HIGH,  
18" or 21" DEEP (cont'd)**

39", 42", 45", or 48"

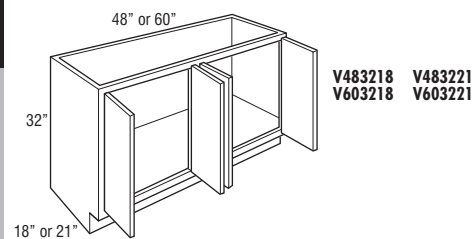
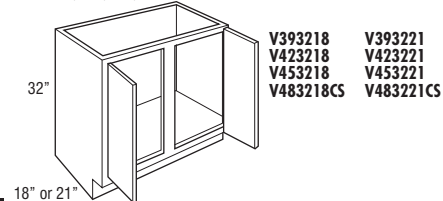

Model	1	2	3	4	5	6
<b>V393218</b>	652	696	737	865	904	950
<b>V423218</b>	696	743	766	913	935	988
<b>V453218</b>	722	771	833	963	988	1046
<b>V483218CS</b>	748	797	896	1013	1040	1102
<b>V393221</b>	652	696	737	865	904	950
<b>V423221</b>	696	743	766	913	935	988
<b>V453221</b>	722	771	833	963	988	1046
<b>V483221CS</b>	748	797	896	1013	1040	1102
<b>V483218</b>	798	854	1026	1111	1144	1216
<b>V603218</b>	1039	1110	1334	1443	1489	1579
<b>V483221</b>	798	854	1026	1111	1144	1216
<b>V603221</b>	1039	1110	1334	1443	1489	1579

Model	7	8	9	10	11	12	13	14	15	16	17	18
<b>V393218</b>	950	1007	1026	1068	1078	1098	1141	1146	1196	1226	1279	1330
<b>V423218</b>	1005	1046	1066	1111	1121	1140	1187	1194	1245	1275	1330	1384
<b>V453218</b>	1058	1107	1128	1174	1186	1209	1256	1262	1315	1350	1407	1464
<b>V483218CS</b>	1113	1167	1190	1239	1251	1273	1325	1331	1388	1425	1484	1544
<b>V393221</b>	950	1007	1026	1068	1078	1098	1141	1146	1196	1226	1279	1330
<b>V423221</b>	1005	1046	1066	1111	1121	1140	1187	1194	1245	1275	1330	1384
<b>V453221</b>	1058	1107	1128	1174	1186	1209	1256	1262	1315	1350	1407	1464
<b>V483221CS</b>	1113	1167	1190	1239	1251	1273	1325	1331	1388	1425	1484	1544

<b>V483218</b>	1220	1287	1314	1367	1378	1405	1462	1469	1530	1573	1638	1703
<b>V603218</b>	1586	1674	1708	1776	1794	1829	1901	1909	1989	2045	2129	2214
<b>V483221</b>	1220	1287	1314	1367	1378	1405	1462	1469	1530	1573	1638	1703
<b>V603221</b>	1586	1674	1708	1776	1794	1829	1901	1909	1989	2045	2129	2214

**Custom Modifications**

AUTHL	AUTHR	CBO	CCO	CFNTO	CFP	CFRMO	CMAT	CND	DRWPWR	DRWTK	EXBKL	EXBKR	EXL	EXR	FB	FFDL	FFDR	FPEB	FTK	FTKAV	FTKRV	ID	INFRM	LTI	MIP	RD	RECTKALL	RECTKLBK	RECTKL	RECTKR	RT	TKP	TOTSSS	VTK	WLI
•			•	•			•	•*				•	•	•		•	•	•	•	•	•	•			•	•	•	•	•	•				•	•

\*Not available on 39", 42", and 45" wide, or on 18" deep

**Construction Upgrades**

APC	PE
•	•

**Door Options**

ALF	CG	DPSRR	MD	MFO
		•		

**VANITY BASE, 34 1/2" HIGH, 18" or 21" DEEP**

12", 15", 18", 21", or 24"

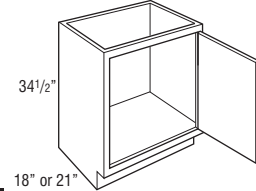

V123418 L or R V123421 L or R  
 V153418 L or R V153421 L or R  
 V183418 L or R V183421 L or R  
 V213418 L or R V213421 L or R  
 V243418 L or R V243421 L or R

24", 27", 30", 33", or 36"

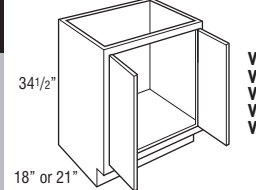

V243418 V243421  
 V273418 V273421  
 V303418 V303421  
 V333418 V333421  
 V363418 V363421

39", 42", 45", or 48"

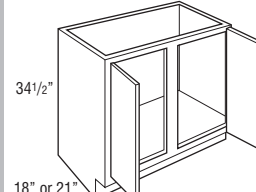

V393418 V393421  
 V423418 V423421  
 V453418 V453421  
 V483418CS V483421CS

48" or 60"

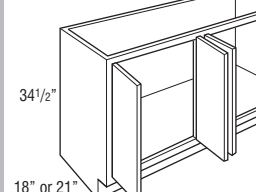

V483418 V483421  
 V603418 V603421

Model	1	2	3	4	5	6
V123418 L or R	416	442	498	533	553	585
V153418 L or R	438	465	524	562	582	617
V183418 L or R	460	490	551	591	614	649
V213418 L or R	501	532	598	643	667	706
V243418 L or R	544	579	650	700	725	766
V123421 L or R	416	442	498	533	553	585
V153421 L or R	438	465	524	562	582	617
V183421 L or R	460	490	551	591	614	649
V213421 L or R	501	532	598	643	667	706
V243421 L or R	544	579	650	700	725	766

V243418	573	611	684	736	762	808
V273418	580	625	730	778	878	925
V303418	631	677	782	832	924	970
V333418	649	696	795	847	960	1013
V363418	669	716	831	884	996	1050
V243421	573	611	684	736	762	808
V273421	580	625	730	778	878	925
V303421	631	677	782	832	924	970
V333421	649	696	795	847	960	1013
V363421	669	716	831	884	996	1050

V393418	692	743	855	912	1029	1083
V423418	716	769	878	935	1059	1114
V453418	743	798	942	986	1113	1134
V483418CS	768	830	1007	1036	1165	1154
V393421	692	743	855	912	1029	1083
V423421	716	769	878	935	1059	1114
V453421	743	798	942	986	1113	1134
V483421CS	768	830	1007	1036	1165	1154

V483418	821	886	1135	1134	1270	1194
V603418	1068	1154	1476	1473	1651	1550
V483421	821	886	1135	1134	1270	1194
V603421	1068	1154	1476	1473	1651	1550

Model	7	8	9	10	11	12	13	14	15	16	17	18
V123418 L or R	587	623	633	660	664	678	706	708	737	759	790	821
V153418 L or R	619	657	667	693	699	714	742	744	777	798	832	866
V183418 L or R	652	689	702	730	735	752	782	784	817	840	875	911
V213418 L or R	709	751	763	793	798	817	847	853	886	914	951	989
V243418 L or R	769	815	830	864	869	886	922	927	965	992	1035	1076
V123421 L or R	587	623	633	660	664	678	706	708	737	759	790	821
V153421 L or R	619	657	667	693	699	714	742	744	777	798	832	866
V183421 L or R	652	689	702	730	735	752	782	784	817	840	875	911
V213421 L or R	709	751	763	793	798	817	847	853	886	914	951	989
V243421 L or R	769	815	830	864	869	886	922	927	965	992	1035	1076

V243418	811	860	873	909	915	934	970	975	1016	1044	1088	1133
V273418	856	981	1000	1040	1050	1071	1114	1119	1167	1198	1248	1297
V303418	915	1030	1051	1092	1101	1126	1169	1174	1223	1259	1311	1364
V333418	932	1074	1093	1137	1146	1170	1218	1223	1274	1310	1366	1421
V363418	974	1113	1135	1181	1189	1215	1263	1270	1324	1356	1414	1470
V243421	811	860	873	909	915	934	970	975	1016	1044	1088	1133
V273421	856	981	1000	1040	1050	1071	1114	1119	1167	1198	1248	1297
V303421	915	1030	1051	1092	1101	1126	1169	1174	1223	1259	1311	1364
V333421	932	1074	1093	1137	1146	1170	1218	1223	1274	1310	1366	1421
V363421	974	1113	1135	1181	1189	1215	1263	1270	1324	1356	1414	1470

V393418	1001	1146	1170	1218	1225	1251	1302	1309	1364	1398	1457	1514
V423418	1030	1181	1204	1254	1263	1287	1340	1346	1401	1441	1501	1559
V453418	1084	1202	1225	1275	1286	1311	1365	1370	1426	1466	1525	1588
V483418CS	1138	1222	1248	1298	1308	1334	1389	1394	1452	1492	1552	1614
V393421	1001	1146	1170	1218	1225	1251	1302	1309	1364	1398	1457	1514
V423421	1030	1181	1204	1254	1263	1287	1340	1346	1401	1441	1501	1559
V453421	1084	1202	1225	1275	1286	1311	1365	1370	1426	1466	1525	1588
V483421CS	1138	1222	1248	1298	1308	1334	1389	1394	1452	1492	1552	1614

V483418	1248	1264	1289	1341	1350	1378	1436	1442	1502	1542	1604	1668
V603418	1622	1642	1676	1744	1756	1794	1865	1873	1953	2004	2087	2170
V483421	1248	1264	1289	1341	1350	1378	1436	1442	1502	1542	1604	1668
V603421	1622	1642	1676	1744	1756	1794	1865	1873	1953	2004	2087	2170

**Custom Modifications**

AUTHL	CBO	CCO	CFNTO	CFP	CFRMO	CMAT	CND	DRWPWR	DRWTK	EXBKL	EXBKR	EXL	EXR	FB	FFDL	FFDR	FPEB	FTK	FTKAV	FTKFV	ID	INFRM	LTI	MIP	RD	RECTKALL	RECTKLBK	RECTKLR	RECTKL	RT	TKP	TOTSSS	VTK	WLI
•		•	•		•	•			•	•	•	•	•	•	•	•	•	•	•	•	•	•	•	•	•	•	•	•	•	•	•	•	•	•

\*Not available on 12", 15", 18", 21", 39", 42", and 45" wide, or on 18" deep \*Not available on 12", 15", 39", 42", 45", 48" and 60" wide, or on 18" deep

\*Not available on 12" wide

**Construction Upgrades**

APC	PE
•	•

**Door Options**

ALF	CG	DPSRR	MD	MFO
		•		

**VANITY SINK BASE with FALSE PANEL, 32" HIGH, 18" or 21" DEEP**

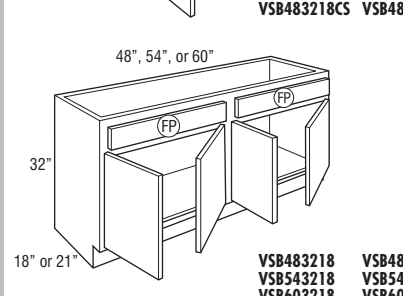
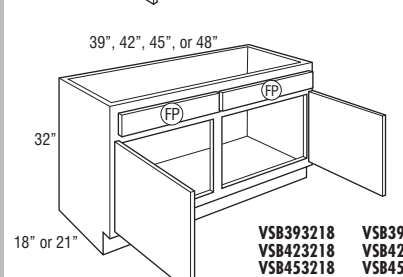
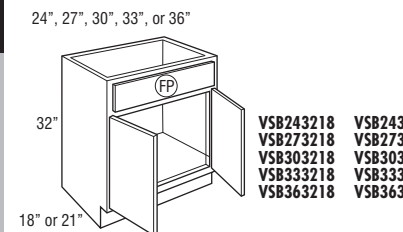
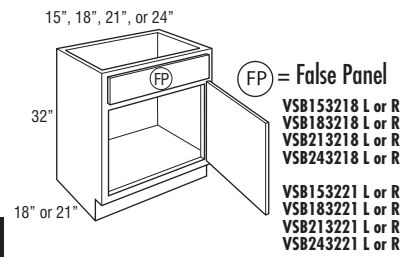

Model	1	2	3	4	5	6
VSB153218 L or R	461	496	561	605	629	664
VSB183218 L or R	486	521	589	637	662	700
VSB213218 L or R	529	566	640	693	719	760
VSB243218 L or R	576	616	697	755	783	826
VSB153221 L or R	461	496	561	605	630	664
VSB183221 L or R	486	521	589	637	663	700
VSB213221 L or R	529	566	640	693	720	760
VSB243221 L or R	576	616	697	755	784	826

VSB243218	605	649	734	793	823	870
VSB273218	618	660	751	821	869	920
VSB303218	629	671	765	857	915	963
VSB333218	664	708	792	894	958	1008
VSB363218	700	745	813	937	996	1048
VSB243221	605	649	734	793	824	870
VSB273221	618	660	750	821	869	920
VSB303221	629	671	765	860	917	963
VSB333221	664	708	790	894	958	1008
VSB363221	700	745	814	936	996	1048

VSB393218	751	801	846	993	1038	1092
VSB423218	801	855	881	1049	1077	1136
VSB453218	831	886	957	1106	1137	1202
VSB483218CS	861	919	1031	1163	1198	1267
VSB393221	751	801	847	993	1038	1092
VSB423221	801	855	881	1049	1077	1136
VSB453221	831	886	957	1106	1137	1202
VSB483221CS	861	919	1031	1163	1198	1267

VSB483218	919	981	1178	1275	1316	1397
<b>NEW</b> VSB543218	983	1050	1260	1364	1408	1495
<b>NEW</b> VSB603218	1084	1158	1390	1505	1553	1648
VSB483221	919	981	1178	1275	1316	1397
<b>NEW</b> VSB543221	983	1050	1260	1364	1408	1495
<b>NEW</b> VSB603221	1084	1158	1390	1505	1553	1648

Model	7	8	9	10	11	12	13	14	15	16	17	18
VSB153218 L or R	667	706	719	750	756	768	798	807	839	862	896	933
VSB183218 L or R	702	742	758	788	794	810	841	847	882	907	943	982
VSB213218 L or R	763	808	823	857	865	880	915	922	961	985	1026	1068
VSB243218 L or R	830	877	894	931	938	959	993	1001	1042	1071	1115	1161
VSB153221 L or R	667	707	719	750	756	768	798	807	839	862	896	933
VSB183221 L or R	702	743	758	788	794	810	841	847	882	907	943	982
VSB213221 L or R	763	809	823	857	865	880	915	922	961	985	1026	1068
VSB243221 L or R	830	878	893	931	938	959	993	1001	1042	1071	1115	1161

VSB243218	873	923	942	981	989	1008	1046	1053	1097	1125	1172	1220
VSB273218	906	972	994	1034	1043	1065	1107	1112	1160	1190	1242	1291
VSB303218	940	1019	1041	1084	1093	1116	1163	1166	1215	1250	1300	1351
VSB333218	986	1069	1088	1133	1142	1166	1214	1217	1267	1304	1357	1414
VSB363218	1032	1111	1134	1176	1188	1215	1262	1266	1319	1354	1410	1467
VSB243221	873	924	940	981	989	1008	1046	1053	1097	1125	1172	1220
VSB273221	906	972	994	1035	1042	1063	1107	1113	1160	1189	1241	1290
VSB303221	943	1019	1041	1084	1092	1116	1162	1166	1215	1249	1300	1351
VSB333221	986	1069	1088	1133	1141	1167	1214	1217	1268	1304	1357	1414
VSB363221	1031	1111	1134	1178	1188	1215	1262	1267	1319	1354	1410	1467

VSB393218	1093	1158	1179	1226	1239	1264	1314	1320	1375	1412	1470	1529
VSB423218	1155	1204	1225	1275	1290	1313	1366	1374	1430	1467	1529	1592
VSB453218	1217	1273	1298	1350	1365	1390	1446	1453	1514	1552	1619	1683
VSB483218CS	1279	1343	1369	1424	1438	1464	1523	1532	1596	1638	1707	1774
VSB393221	1093	1158	1179	1226	1239	1264	1314	1321	1375	1412	1470	1529
VSB423221	1155	1204	1225	1275	1290	1313	1366	1374	1430	1467	1529	1592
VSB453221	1217	1273	1298	1350	1365	1390	1446	1453	1514	1552	1619	1683
VSB483221CS	1279	1343	1369	1424	1438	1464	1523	1532	1596	1638	1707	1774

VSB483218	1403	1480	1511	1572	1584	1617	1683	1689	1757	1807	1884	1958
VSB543218	1501	1584	1617	1682	1695	1730	1801	1807	1880	1933	2016	2095
VSB603218	1656	1746	1783	1855	1869	1908	1986	1993	2073	2132	2223	2310
VSB483221	1403	1480	1511	1572	1584	1617	1683	1689	1757	1807	1884	1958
VSB543221	1501	1584	1617	1682	1695	1730	1801	1807	1880	1933	2016	2095
VSB603221	1656	1746	1783	1855	1869	1908	1986	1993	2073	2132	2223	2310

**Custom Modifications**

AUTHL	CBO	CCO	CFNTO	CFP	CFRMO	CMAT	CND	DRWPWR	DRWTK	EXBKL	EXBKR	EXL	EXR	FB	FFDL	FFDR	FPEB	FTK	FTKAV	FTKFV	ID	INVFRM	LTI	MIP	RD	RECTKALL	RECTKLBK	RECTKL	RECTKR	RT	TKP	TOTSSS	VTK	WLI
•	•	•	•	•	•	•	•	•	•	•	•	•	•	•	•	•	•	•	•	•	•	•	•	•	•	•	•	•	•	•	•	•	•	•

\*Not available on 15", 18", 21", 39", 42", and 45" wide, or on 18" deep. \*Not available on 15", 39", 42", 48", 54", and 60" wide, or on 18" deep.

**Construction Upgrades**

APC	PE
•	•

**Door Options**

ALF	CG	DPSRR	MD	MFO
•	•	•	•	•

**VANITY SINK BASE with FALSE PANEL,  
34 1/2" HIGH, 18" or 21" DEEP**

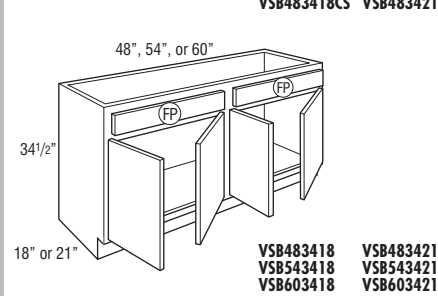
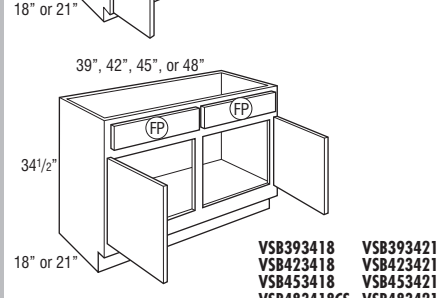
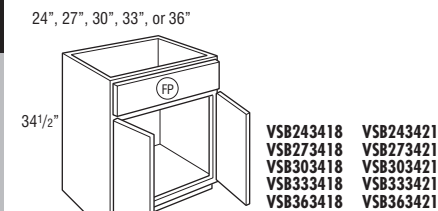
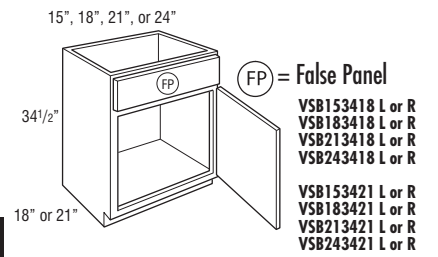

Model	1	2	3	4	5	6
VS B153418 L or R	503	534	601	646	670	709
VS B183418 L or R	529	563	633	681	706	745
VS B213418 L or R	576	613	687	740	766	811
VS B243418 L or R	625	666	747	806	833	881
VS B153421 L or R	503	534	601	646	670	709
VS B183421 L or R	529	563	633	681	706	745
VS B213421 L or R	576	613	687	740	766	811
VS B243421 L or R	625	666	747	806	833	881

VS B243418	659	701	786	845	877	928
VS B273418	667	718	837	892	1010	1063
VS B303418	727	779	897	959	1062	1117
VS B333418	745	798	917	975	1101	1165
VS B363418	769	826	958	1018	1145	1211
VS B243421	659	701	786	845	877	928
VS B273421	667	718	837	892	1010	1063
VS B303421	727	779	897	959	1062	1117
VS B333421	745	798	917	975	1101	1165
VS B363421	769	826	958	1018	1145	1211

VS B393418	797	856	984	1047	1182	1246
VS B423418	824	884	1010	1077	1218	1280
VS B453418	855	919	1084	1134	1279	1304
VS B483418CS	884	954	1159	1190	1340	1328
VS B393421	797	856	984	1047	1182	1246
VS B423421	824	884	1010	1077	1218	1280
VS B453421	855	919	1084	1134	1279	1304
VS B483421CS	884	954	1159	1190	1340	1328

VS B483418	943	1020	1305	1304	1461	1374
<b>NEW</b> VS B543418	1101	1176	1411	1528	1577	1674
<b>NEW</b> VS B603418	1214	1297	1557	1686	1739	1846
VS B483421	943	1020	1305	1304	1461	1374
<b>NEW</b> VS B543421	1101	1176	1411	1528	1577	1674
<b>NEW</b> VS B603421	1214	1297	1557	1686	1739	1846

Model	7	8	9	10	11	12	13	14	15	16	17	18
VS B153418 L or R	711	755	767	795	805	822	853	861	892	920	959	993
VS B183418 L or R	750	793	809	837	845	867	896	906	939	968	1009	1046
VS B213418 L or R	814	864	878	912	920	940	975	982	1022	1051	1096	1137
VS B243418 L or R	884	936	956	990	999	1023	1060	1068	1112	1142	1190	1237
VS B153421 L or R	711	755	767	795	805	822	853	861	892	920	959	993
VS B183421 L or R	750	793	809	837	845	867	896	906	939	968	1009	1046
VS B213421 L or R	814	864	878	912	920	940	975	982	1022	1051	1096	1137
VS B243421 L or R	884	936	956	990	999	1023	1060	1068	1112	1142	1190	1237

VS B243418	931	986	1005	1042	1051	1077	1117	1123	1169	1203	1253	1303
VS B273418	982	1130	1150	1197	1211	1229	1280	1289	1342	1378	1436	1493
VS B303418	1052	1183	1212	1258	1268	1293	1344	1348	1405	1447	1506	1566
VS B333418	1074	1232	1259	1309	1320	1345	1399	1405	1464	1508	1572	1635
VS B363418	1121	1279	1305	1357	1370	1395	1451	1461	1522	1560	1626	1691
VS B243421	931	986	1005	1042	1051	1077	1117	1123	1169	1203	1253	1303
VS B273421	982	1130	1150	1197	1211	1229	1280	1289	1342	1378	1436	1493
VS B303421	1052	1183	1212	1258	1268	1293	1344	1348	1405	1447	1506	1566
VS B333421	1074	1232	1259	1309	1320	1345	1399	1405	1464	1508	1572	1635
VS B363421	1121	1279	1305	1357	1370	1395	1451	1461	1522	1560	1626	1691

VS B393418	1153	1320	1345	1399	1410	1438	1496	1505	1568	1607	1678	1744
VS B423418	1184	1357	1385	1442	1451	1480	1541	1549	1614	1656	1727	1796
VS B453418	1248	1381	1410	1466	1476	1507	1568	1576	1644	1685	1756	1828
VS B483418CS	1310	1405	1432	1492	1503	1534	1596	1603	1671	1715	1786	1857
VS B393421	1153	1320	1345	1399	1410	1438	1496	1505	1568	1607	1678	1744
VS B423421	1184	1357	1385	1442	1451	1480	1541	1549	1614	1656	1727	1796
VS B453421	1248	1381	1410	1466	1476	1507	1568	1576	1644	1685	1756	1828
VS B483421CS	1310	1405	1432	1492	1503	1534	1596	1603	1671	1715	1786	1857

VS B483418	1435	1452	1481	1542	1554	1584	1650	1657	1728	1773	1845	1919
VS B543418	1681	1774	1811	1884	1898	1938	2017	2024	2106	2165	2258	2346
VS B603418	1855	1956	1997	2078	2093	2137	2224	2232	2322	2388	2490	2587
VS B483421	1435	1452	1481	1542	1554	1584	1650	1657	1728	1773	1845	1919
VS B543421	1681	1774	1811	1884	1898	1938	2017	2024	2106	2165	2258	2346
VS B603421	1855	1956	1997	2078	2093	2137	2224	2232	2322	2388	2490	2587

**Custom Modifications**

AUTHL	AUTHR	CBO	CCO	CFNTO	CFP	CFRMO	CMAT	CND	DRWPWR	DRWTK	EXBKL	EXBKR	EXL	EXR	FB	FFDL	FFDR	FPEB	FTK	FTKAV	FTKEV	ID	INFRM	LTI	MIP	RD	RECTKALL	RECTKLBK	RECTKLR	RT	TKP	TOTSSS	VTK	WLI
•	•	•	•	•	•	•	•	•	•	•	•	•	•	•	•	•	•	•	•	•	•	•	•	•	•	•	•	•	•	•	•	•	•	•

\*Not available on 15", 18", 21", 39", 42", and 45" wide, or on 18" deep \*Not available on 15", 39", 42", 48", 54", and 60" wide, or on 18" deep

**Construction Upgrades**

APC	PE
•	•

**Door Options**

ALF	CG	DPSRR	MD	MFO
•	•	•	•	•

**VANITY SINK BASE with U-SHAPED ROLL-OUT TRAY, 32" HIGH, 21" DEEP**

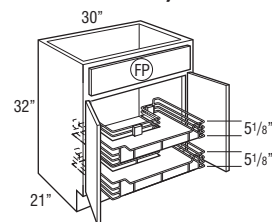

Model	1	2	3	4	5	6
<b>VS8303221U</b>	1422	1464	1558	1653	1710	1756

- Includes two chrome U-shaped Smart Stop roll-outs with gray shelf liner.
- Bottom roll-out is 25 1/4" wide and 17" deep. Cut-out for U-shape is 6 1/8" from back of cabinet and 15 3/4" wide.
- Top roll-out is 25 1/4" wide and 17" deep. Cut-out for U-shape is 12 1/8" from back of cabinet and 15 3/4" wide.\*
- Trays are 25 21/32" wide and 17 23/32" deep.

Model	7	8	9	10	11	12	13	14	15	16	17	18
<b>VS8303221U</b>	1736	1812	1834	1877	1885	1909	1955	1959	2008	2042	2093	2144

**Custom Modifications**

AUTHL	AUTHR	CBO	CCO	CFNTO	CFP	CFRMO	CMAT	CND	DRWPWR	DRWTK	EXBKL	EXBKR	EXL	EXR	FB	FFDL	FFDR	FPEB	FTK	FTKAV	FTKRV	ID	INVFRM	LTI	MIP	RD	RECTKALL	RECTKRBK	RECTKLR	RECTKR	RT	TKP	TOTSSS	VTK	WLI	
•	•	•	•	•	•	•	•	•	•	•	•	•	•	•	•	•	•	•	•	•	•	•	•	•	•	•	•	•	•	•	•	•	•	•	•	•

**Construction Upgrades**

APC	PE
•	•

**Door Options**

ALF	CG	DPSRR	MD	MFO
•	•	•	•	•

<b>VS8303421U</b>	1845	1976	2005	2051	2061	2086	2137	2141	2198	2240	2299	2359
-------------------	------	------	------	------	------	------	------	------	------	------	------	------

**Custom Modifications**

AUTHL	AUTHR	CBO	CCO	CFNTO	CFP	CFRMO	CMAT	CND	DRWPWR	DRWTK	EXBKL	EXBKR	EXL	EXR	FB	FFDL	FFDR	FPEB	FTK	FTKAV	FTKRV	ID	INVFRM	LTI	MIP	RD	RECTKALL	RECTKRBK	RECTKLR	RECTKR	RT	TKP	TOTSSS	VTK	WLI	
•	•	•	•	•	•	•	•	•	•	•	•	•	•	•	•	•	•	•	•	•	•	•	•	•	•	•	•	•	•	•	•	•	•	•	•	•

**Construction Upgrades**

APC	PE
•	•

**Door Options**

ALF	CG	DPSRR	MD	MFO
•	•	•	•	•

<b>VS8243421WB L or R</b>	1130	1185	1204	1241	1250	1276	1316	1322	1368	1402	1452	1502
---------------------------	------	------	------	------	------	------	------	------	------	------	------	------

<b>VS8303421WB L or R</b>	1251	1382	1411	1457	1467	1492	1543	1547	1604	1646	1705	1765
---------------------------	------	------	------	------	------	------	------	------	------	------	------	------

**Custom Modifications**

AUTHL	AUTHR	CBO	CCO	CFNTO	CFP	CFRMO	CMAT	CND	DRWPWR	DRWTK	EXBKL	EXBKR	EXL	EXR	FB	FFDL	FFDR	FPEB	FTK	FTKAV	FTKRV	ID	INVFRM	LTI	MIP	RD	RECTKALL	RECTKRBK	RECTKLR	RECTKR	RT	TKP	TOTSSS	VTK	WLI	
•	•	•	•	•	•	•	•	•	•	•	•	•	•	•	•	•	•	•	•	•	•	•	•	•	•	•	•	•	•	•	•	•	•	•	•	•

**Construction Upgrades**

APC	PE
•	•

**Door Options**

ALF	CG	DPSRR	MD	MFO
•	•	•	•	•

<b>VSS8303421STWB L or R</b>	1833	1964	1993	2039	2049	2074	2125	2129	2186	2228	2287	2347
------------------------------	------	------	------	------	------	------	------	------	------	------	------	------

<b>VSS8333421STWB L or R</b>	1855	2013	2040	2090	2101	2126	2180	2186	2245	2289	2353	2416
------------------------------	------	------	------	------	------	------	------	------	------	------	------	------

<b>VSS8363421STWB L or R</b>	1902	2060	2086	2138	2151	2176	2232	2242	2303	2341	2407	2472
------------------------------	------	------	------	------	------	------	------	------	------	------	------	------

**Custom Modifications**

AUTHL	AUTHR	CBO	CCO	CFNTO	CFP	CFRMO	CMAT	CND	DRWPWR	DRWTK	EXBKL	EXBKR	EXL	EXR	FB	FFDL	FFDR	FPEB	FTK	FTKAV	FTKRV	ID	INVFRM	LTI	MIP	RD	RECTKALL	RECTKRBK	RECTKLR	RECTKR	RT	TKP	TOTSSS	VTK	WLI	
•	•	•	•	•	•	•	•	•	•	•	•	•	•	•	•	•	•	•	•	•	•	•	•	•	•	•	•	•	•	•	•	•	•	•	•	•

**Construction Upgrades**

APC	PE
•	•

**Door Options**

ALF	CG	DPSRR	MD	MFO
•	•	•	•	•

<b>VSS8303421ST</b>	1634	1765	1794	1840	1850	1875	1926	1930	1987	2029	2088	2148
---------------------	------	------	------	------	------	------	------	------	------	------	------	------

<b>VSS8333421ST</b>	1656	1814	1841	1891	1902	1927	1981	1987	2046	2090	2154	2217
---------------------	------	------	------	------	------	------	------	------	------	------	------	------

<b>VSS8363421ST</b>	1703	1861	1887	1939	1952	1977	2033	2043	2104	2142	2208	2273
---------------------	------	------	------	------	------	------	------	------	------	------	------	------

**Custom Modifications**

AUTHL	AUTHR	CBO	CCO	CFNTO	CFP	CFRMO	CMAT	CND	DRWPWR	DRWTK	EXBKL	EXBKR	EXL	EXR	FB	FFDL	FFDR	FPEB	FTK	FTKAV	FTKRV	ID	INVFRM	LTI	MIP	RD	RECTKALL	RECTKRBK	RECTKLR	RECTKR	RT	TKP	TOTSSS	VTK	WLI	
•	•	•	•	•	•	•	•	•	•	•	•	•	•	•	•	•	•	•	•	•	•	•	•	•	•	•	•	•	•	•	•	•	•	•	•	•

**Construction Upgrades**

APC	PE
•	•

**Door Options**

ALF	CG	DPSRR	MD	MFO
•	•	•	•	•

**VANITY SINK BASE with U-SHAPED ROLL-OUT TRAY, 34 1/2" HIGH, 21" DEEP**

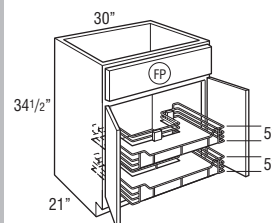

<b>VS8303421U</b>	1520	1572	1690	1752	1855	1910
-------------------	------	------	------	------	------	------

- Includes two chrome U-shaped Smart Stop roll-outs with gray shelf liner.
- Cut-out for U-shape on bottom roll-out is 6 1/8" from back of cabinet.
- Cut-out for U-shape on top roll-out is 12 1/8" from back of cabinet.
- Trays are 25 21/32" wide and 17 23/32" deep.

**VANITY SINK BASE with WASTEBASKET, 34 1/2" HIGH, 21" DEEP**

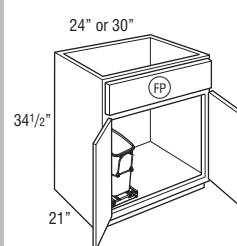

<b>VS8243421WB L or R</b>	858	900	985	1044	1076	1127
---------------------------	-----	-----	-----	------	------	------

<b>VS8303421WB L or R</b>	926	978	1096	1158	1261	1316
---------------------------	-----	-----	------	------	------	------

- Bottom mounted zinc colored Smart Stop guides with 20 quart gray wastebasket inserted in chrome support. Dimensions of unit: 8.5"W x 16.7"H x 17.7"D.
- L or R designates wastebasket location.

**VANITY SINK BASE SUPERCABINET™ with TILT-OUT TRAYS and WASTEBASKET, 34 1/2" HIGH, 21" DEEP**

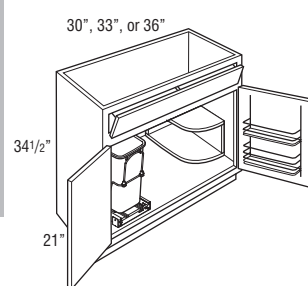

<b>VSS8303421STWB L or R</b>	1508	1560	1678	1740	1843	1898
------------------------------	------	------	------	------	------	------

<b>VSS8333421STWB L or R</b>	1526	1579	1698	1756	1882	1946
------------------------------	------	------	------	------	------	------

<b>VSS8363421STWB L or R</b>	1550	1607	1739	1799	1926	1992
------------------------------	------	------	------	------	------	------

- Quarter Round Reversible Shelf for left or right applications will be constructed from 3/4" thick laminated furniture board. When upgraded to APC, shelf will use clear coated veneer plywood. (Shelf shipped secure, can be positioned in left or right corner.)
- Door on the side with the Quarter Round Shelf features a chrome and wood two-tiered rack.
- Door rack width is 11 3/8" on 30" and 33" wide cabinets and 14 3/8" on 36" wide cabinet.
- Door rack depth is 3 1/2".
- Includes 2 installed tilt-out trays.
- Tilt-out trays are stain resistant, moisture resistant plastic to allow storage of sponges & other cleaning materials.
- Tilt-out trays are also available as an accessory for field installation. See page 584.
- All load bearing service meet KCMA standards of 15 lbs. per square foot.
- Bottom mounted zinc colored Smart Stop guides with 20 quart gray wastebasket inserted in chrome support. Dimensions of unit: 8.5"W x 16.7"H x 17.7"D.
- L or R designates wastebasket location.

**VANITY SINK BASE SUPERCABINET™ with TILT-OUT TRAYS, 34 1/2" HIGH, 21" DEEP**

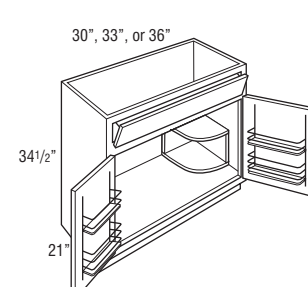

<b>VSS8303421ST</b>	1309	1361	1479	1541	1644	1699
---------------------	------	------	------	------	------	------

<b>VSS8333421ST</b>	1327	1380	1499	1557	1683	1747
---------------------	------	------	------	------	------	------

<b>VSS8363421ST</b>	1351	1408	1540	1600	1727	1793
---------------------	------	------	------	------	------	------

- Quarter Round Reversible Shelf for left or right applications will be constructed from 3/4" thick laminated furniture board. When upgraded to APC, shelf will use clear coated veneer plywood. (Shelf shipped secure, can be positioned in left or right corner.)
- Each door features a chrome and wood two-tiered rack.
- Door rack width is 11 3/8" on 30" and 33" wide cabinets and 14 3/8" on 36" wide cabinet.
- Door rack depth is 3 1/2".
- Includes 2 installed tilt-out trays.
- Tilt-out trays are stain resistant, moisture resistant plastic to allow storage of sponges & other cleaning materials.
- Tilt-out trays are also available as an accessory for field installation. See page 584.
- All load bearing service meet KCMA standards of 15 lbs. per square foot.



**VANITY BASE, SINGLE DOOR with DRAWER, 32" HIGH, 18" or 21" DEEP**

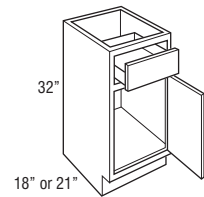

Model	1	2	3	4	5	6
VB123218 L or R	617	649	693	740	740	740
VB153218 L or R	657	687	728	794	793	794
VB183218 L or R	678	709	751	824	822	824
VB213218 L or R	715	752	791	855	852	855
VB243218 L or R	786	827	869	924	913	924
VB123221 L or R	617	649	693	740	740	740
VB153221 L or R	657	687	728	794	793	794
VB183221 L or R	678	709	751	824	822	824
VB213221 L or R	715	752	791	855	852	855
VB243221 L or R	786	827	869	924	913	924

**VANITY BASE, SINGLE DOOR with DRAWER, 34 1/2" HIGH, 18" or 21" DEEP**

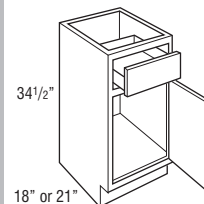

VB123418 L or R	651	681	734	780	780	780
VB153418 L or R	686	716	777	818	818	818
VB183418 L or R	707	742	797	864	857	864
VB213418 L or R	743	782	853	923	921	931
VB243418 L or R	817	860	915	985	982	999
VB123421 L or R	651	681	734	780	780	780
VB153421 L or R	686	716	777	818	818	818
VB183421 L or R	707	742	797	864	857	864
VB213421 L or R	743	782	853	923	921	931
VB243421 L or R	817	860	915	985	982	999

Model	7	8	9	10	11	12	13	14	15	16	17	18
VB123218 L or R	815	782	793	821	831	843	874	877	911	934	968	1008
VB153218 L or R	874	837	853	883	889	909	939	943	980	1005	1042	1084
VB183218 L or R	909	869	884	917	923	939	972	980	1016	1041	1081	1124
VB213218 L or R	938	904	918	954	960	975	1013	1016	1053	1083	1124	1169
VB243218 L or R	1017	975	992	1031	1037	1057	1096	1099	1141	1171	1217	1266
VB123221 L or R	815	782	793	821	831	843	874	877	911	934	968	1008
VB153221 L or R	874	837	853	883	889	909	939	943	980	1005	1042	1084
VB183221 L or R	909	869	884	917	923	939	972	980	1016	1041	1081	1124
VB213221 L or R	938	904	918	954	960	975	1013	1016	1053	1083	1124	1169
VB243221 L or R	1017	975	992	1031	1037	1057	1096	1099	1141	1171	1217	1266

Custom Modifications

AUTHL	AUTHR	CBO	CCO	CFNTO	CFP	CFRMO	CMAT	CND	DRWPWR	DRWTK	EXBKL	EXBKR	EXL	EXR	FB	FFDL	FFDR	FPEB	FTK	FTKAV	FTKRV	ID	INVFRM	LTI	MIP	RD	RECTKALL	RECTKRBK	RECTKLR	RECTKR	RT	TKP	TOTSSS	VTK	WLI
•	•	•	•	•	•	•	•	•	•	•*	•	•	•	•	•	•	•	•	•	•*	•	•	•	•*	•	•	•	•	•	•	•	•	•	•	•

\*Not available on 12" and 15" wide, or on 18" deep \*Not available on 12" wide

Construction Upgrades

APC	PE
•	•

Door Options

ALF	CG	DPSRR	MD	MFO
•	•	•	•	•

VB123418 L or R	860	820	836	866	871	886	919	924	960	985	1019	1060
VB153418 L or R	898	862	875	910	915	931	965	969	1008	1032	1072	1114
VB183418 L or R	949	911	925	961	966	986	1020	1024	1063	1092	1134	1178
VB213418 L or R	1016	984	999	1038	1044	1063	1102	1110	1150	1178	1224	1273
VB243418 L or R	1083	1053	1075	1114	1122	1142	1186	1190	1237	1269	1317	1371
VB123421 L or R	860	820	836	866	871	886	919	924	960	985	1019	1060
VB153421 L or R	898	862	875	910	915	931	965	969	1008	1032	1072	1114
VB183421 L or R	949	911	925	961	966	986	1020	1024	1063	1092	1134	1178
VB213421 L or R	1016	984	999	1038	1044	1063	1102	1110	1150	1178	1224	1273
VB243421 L or R	1083	1053	1075	1114	1122	1142	1186	1190	1237	1269	1317	1371

Custom Modifications

AUTHL	AUTHR	CBO	CCO	CFNTO	CFP	CFRMO	CMAT	CND	DRWPWR	DRWTK	EXBKL	EXBKR	EXL	EXR	FB	FFDL	FFDR	FPEB	FTK	FTKAV	FTKRV	ID	INVFRM	LTI	MIP	RD	RECTKALL	RECTKRBK	RECTKLR	RECTKR	RT	TKP	TOTSSS	VTK	WLI
•	•	•	•	•	•	•	•	•	•*	•*	•	•	•	•	•	•	•	•	•	•*	•*	•	•	•*	•	•	•	•	•	•	•	•	•	•	•

\*Not available on 12" and 15" wide \*Not available on 12" and 15" wide, or on 18" deep \*Not available on 12" wide

Construction Upgrades

APC	PE
•	•

Door Options

ALF	CG	DPSRR	MD	MFO
•	•	•	•	•

**VANITY BASE, DOUBLE DOOR with DRAWER, 32" HIGH, 18" or 21" DEEP**

24", 27", 30", 33", or 36"

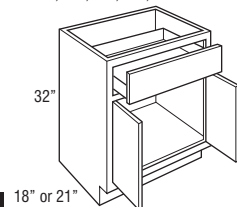

VB243218 VB243221  
 VB273218 VB273221  
 VB303218 VB303221  
 VB333218 VB333221  
 VB363218 VB363221

39", 42", 45", or 48"

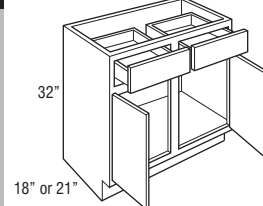

VB393218 VB393221  
 VB423218 VB423221  
 VB453218 VB453221  
 VB483218CS VB483221CS

48"

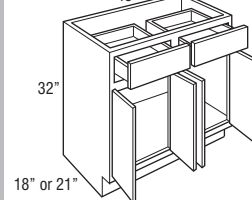

VB483218  
 VB483221

Model	1	2	3	4	5	6
VB243218	857	904	944	994	974	994
VB273218	957	1007	1053	1111	1086	1111
VB303218	1008	1062	1113	1171	1145	1171
VB333218	1042	1098	1152	1214	1186	1214
VB363218	1080	1136	1192	1255	1226	1255
VB243221	857	904	944	994	974	994
VB273221	957	1007	1053	1111	1086	1111
VB303221	1008	1062	1113	1171	1145	1171
VB333221	1042	1098	1152	1214	1186	1214
VB363221	1080	1136	1192	1255	1226	1255
VB393218	1144	1204	1263	1331	1300	1331
VB423218	1207	1271	1333	1404	1372	1404
VB453218	1268	1335	1399	1475	1442	1475
VB483218CS	1328	1398	1465	1546	1509	1546
VB393221	1144	1204	1263	1331	1300	1331
VB423221	1207	1271	1333	1404	1372	1404
VB453221	1268	1335	1399	1475	1442	1475
VB483221CS	1328	1398	1465	1546	1509	1546
VB483218	1449	1524	1599	1685	1646	1685
VB483221	1449	1524	1599	1685	1646	1685

Model	7	8	9	10	11	12	13	14	15	16	17	18
VB243218	1095	1048	1068	1107	1115	1138	1178	1183	1228	1260	1309	1362
VB273218	1220	1169	1190	1233	1243	1270	1315	1320	1371	1404	1458	1516
VB303218	1287	1232	1255	1302	1311	1340	1388	1392	1447	1481	1541	1601
VB333218	1333	1275	1299	1347	1356	1388	1436	1441	1497	1535	1595	1657
VB363218	1378	1321	1344	1395	1404	1436	1487	1492	1549	1588	1650	1715
VB243221	1095	1048	1068	1107	1115	1138	1178	1183	1228	1260	1309	1362
VB273221	1220	1169	1190	1233	1243	1270	1315	1320	1371	1404	1458	1516
VB303221	1287	1232	1255	1302	1311	1340	1388	1392	1447	1481	1541	1601
VB333221	1333	1275	1299	1347	1356	1388	1436	1441	1497	1535	1595	1657
VB363221	1378	1321	1344	1395	1404	1436	1487	1492	1549	1588	1650	1715
VB393218	1461	1399	1425	1479	1490	1521	1574	1581	1642	1682	1749	1816
VB423218	1543	1477	1503	1560	1571	1605	1660	1667	1733	1773	1845	1917
VB453218	1620	1551	1578	1639	1650	1686	1745	1751	1821	1863	1938	2012
VB483218CS	1697	1625	1654	1717	1728	1767	1828	1835	1907	1952	2031	2108
VB393221	1461	1399	1425	1479	1490	1521	1574	1581	1642	1682	1749	1816
VB423221	1543	1477	1503	1560	1571	1605	1660	1667	1733	1773	1845	1917
VB453221	1620	1551	1578	1639	1650	1686	1745	1751	1821	1863	1938	2012
VB483221CS	1697	1625	1654	1717	1728	1767	1828	1835	1907	1952	2031	2108
VB483218	1851	1772	1803	1873	1885	1926	1994	2002	2079	2129	2214	2301
VB483221	1851	1772	1803	1873	1885	1926	1994	2002	2079	2129	2214	2301

**Custom Modifications**

AUTHL	AUTHR	CBO	CCO	CFNTO	CFP	CFRMO	CMAT	CND	DRWPWR	DRWTK	EXBKL	EXBKR	EXL	EXR	FB	FFDL	FFDR	FPEB	FTK	FTKAV	FTKRV	ID	INVFRM	LTI	MIP	RD	RECTKALL	RECTKRBK	RECTKL	RECTKR	RT	TKP	TOTSSS	VTK	WLI
•	•	•	•	•	•	•	•	•	•	•	•	•	•	•	•	•	•	•	•	•	•	•	•	•	•	•	•	•	•	•	•	•	•	•	•

\*Not available on 39", 42", 45" and 48" wide, or on 18" deep

**Construction Upgrades**

APC	PE
•	•

**Door Options**

ALF	CG	DPSRR	MD	MFO
•	•	•	•	•



**VANITY DRAWER BASE,  
32" HIGH, 18" or 21" DEEP**

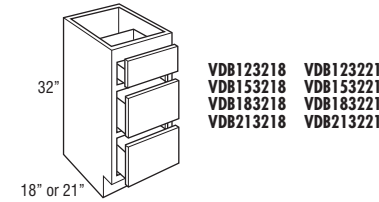

VDB123218 VDB123221  
VDB153218 VDB153221  
VDB183218 VDB183221  
VDB213218 VDB213221

24", 27", 30", 33", or 36"

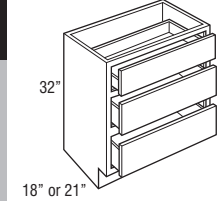

VDB243218 VDB243221  
VDB273218 VDB273221  
VDB303218 VDB303221  
VDB333218 VDB333221  
VDB363218 VDB363221

18" or 21"

Model	1	2	3	4	5	6
VDB123218	1201	1201	1201	1201	1201	1201
VDB153218	1260	1260	1260	1260	1260	1260
VDB183218	1309	1309	1309	1309	1314	1314
VDB213218	1357	1357	1357	1357	1357	1357
VDB123221	1201	1201	1201	1201	1201	1201
VDB153221	1260	1260	1260	1260	1260	1260
VDB183221	1309	1309	1309	1309	1314	1314
VDB213221	1357	1357	1357	1357	1357	1357
VDB243218	1399	1399	1399	1399	1408	1408
VDB273218	1512	1512	1512	1512	1520	1520
VDB303218	1633	1633	1633	1633	1642	1642
VDB333218	1763	1763	1763	1763	1773	1773
VDB363218	1903	1903	1903	1903	1915	1915
VDB243221	1399	1399	1399	1408	1408	1408
VDB273221	1512	1512	1512	1520	1520	1520
VDB303221	1633	1633	1633	1642	1642	1642
VDB333221	1763	1763	1763	1773	1773	1773
VDB363221	1903	1903	1903	1915	1915	1915

Model	7	8	9	10	11	12	13	14	15	16	17	18
VDB123218	1321	1256	1277	1317	1328	1347	1392	1396	1445	1476	1525	1589
VDB153218	1388	1320	1341	1387	1394	1416	1461	1470	1519	1551	1604	1668
VDB183218	1441	1376	1397	1445	1452	1478	1525	1535	1588	1622	1679	1745
VDB213218	1495	1427	1449	1496	1506	1534	1582	1593	1646	1683	1742	1809
VDB123221	1321	1256	1277	1317	1328	1347	1392	1396	1445	1476	1525	1589
VDB153221	1388	1320	1341	1387	1394	1416	1461	1470	1519	1551	1604	1668
VDB183221	1441	1376	1397	1445	1452	1478	1525	1535	1588	1622	1679	1745
VDB213221	1495	1427	1449	1496	1506	1534	1582	1593	1646	1683	1742	1809
VDB243218	1541	1481	1506	1554	1566	1594	1647	1654	1710	1749	1809	1884
VDB273218	1664	1601	1626	1680	1691	1720	1778	1786	1848	1888	1955	2035
VDB303218	1797	1729	1756	1812	1827	1857	1921	1929	1996	2039	2111	2199
VDB333218	1940	1868	1897	1958	1973	2006	2074	2084	2154	2203	2280	2375
VDB363218	2096	2016	2049	2116	2130	2168	2238	2250	2328	2379	2464	2563
VDB243221	1551	1481	1506	1554	1566	1594	1647	1654	1710	1749	1809	1884
VDB273221	1675	1601	1626	1680	1691	1720	1778	1786	1848	1888	1955	2035
VDB303221	1808	1729	1756	1812	1827	1857	1921	1929	1996	2039	2111	2199
VDB333221	1954	1868	1897	1958	1973	2006	2074	2084	2154	2203	2280	2375
VDB363221	2110	2016	2049	2116	2130	2168	2238	2250	2328	2379	2464	2563

**Custom Modifications**

AUTHL	AUTHR	CBO	CCO	CFNTO	CFP	CFRMO	CMAT	CND	DRWPWR	DRWTK	EXBKL	EXBKR	EXL	EXR	FB	FFDL	FFDR	FPEB	FTK	FTKAV	FTKRV	ID	INFRM	LTI	MIP	RD	RECTKALL	RECTKLBK	RECTKL	RECTKR	RT	TKP	TOTSSS	VTK	WLI
•	•	•	•	•	•	•	•	•	•*	•*	•	•	•	•	•	•	•	•	•	•	•	•	•	•	•	•	•	•	•	•	•	•	•	•	•

\*Not available on 12" and 15" wide    \*Not available on 12" and 15" wide, or on 18" deep    †Not available on 12" wide

**Construction Upgrades**

APC	PE
•	•

**Door Options**

ALF	CG	DPSRR	MD	MFO
•	•	•	•	•

**VANITY DRAWER BASE,  
34 1/2" HIGH, 18" or 21" DEEP**

12", 15", 18", or 21"

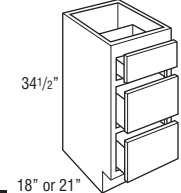

VDB123418 VDB123421  
VDB153418 VDB153421  
VDB183418 VDB183421  
VDB213418 VDB213421

18" or 21"

24", 27", 30", 33", or 36"

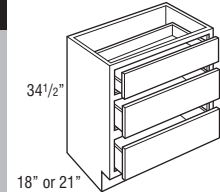

VDB243418 VDB243421  
VDB273418 VDB273421  
VDB303418 VDB303421  
VDB333418 VDB333421  
VDB363418 VDB363421

18" or 21"

Model	1	2	3	4	5	6
VDB123418	1216	1216	1216	1216	1216	1216
VDB153418	1270	1270	1270	1270	1270	1270
VDB183418	1340	1340	1340	1340	1340	1340
VDB213418	1408	1408	1408	1408	1408	1408
VDB123421	1216	1216	1216	1216	1216	1216
VDB153421	1270	1270	1270	1270	1270	1270
VDB183421	1340	1340	1340	1340	1340	1340
VDB213421	1408	1408	1408	1408	1408	1408
VDB243418	1484	1484	1484	1484	1484	1484
VDB273418	1603	1603	1603	1603	1603	1603
VDB303418	1732	1732	1732	1732	1732	1732
VDB333418	1870	1870	1870	1870	1870	1870
VDB363418	2020	2020	2020	2020	2020	2020
VDB243421	1484	1484	1484	1484	1484	1484
VDB273421	1603	1603	1603	1603	1603	1603
VDB303421	1732	1732	1732	1732	1732	1732
VDB333421	1870	1870	1870	1870	1870	1870
VDB363421	2020	2020	2020	2020	2020	2020

Model	7	8	9	10	11	12	13	14	15	16	17	18
VDB123418	1338	1273	1292	1335	1344	1366	1407	1416	1463	1496	1548	1608
VDB153418	1396	1330	1349	1394	1403	1428	1475	1478	1529	1563	1618	1683
VDB183418	1473	1401	1427	1473	1482	1507	1557	1562	1617	1656	1712	1782
VDB213418	1551	1481	1506	1554	1566	1594	1647	1654	1710	1749	1809	1884
VDB123421	1338	1273	1292	1335	1344	1366	1407	1416	1463	1496	1548	1608
VDB153421	1396	1330	1349	1394	1403	1428	1475	1478	1529	1563	1618	1683
VDB183421	1473	1401	1427	1473	1482	1507	1557	1562	1617	1656	1712	1782
VDB213421	1551	1481	1506	1554	1566	1594	1647	1654	1710	1749	1809	1884
VDB243418	1633	1557	1584	1638	1650	1678	1735	1742	1801	1845	1911	1987
VDB273418	1763	1682	1711	1769	1782	1810	1874	1881	1945	1994	2063	2147
VDB303418	1903	1816	1849	1911	1925	1956	2024	2032	2100	2152	2230	2318
VDB333418	2056	1961	1997	2063	2079	2112	2185	2192	2268	2326	2409	2505
VDB363418	2220	2119	2156	2230	2245	2282	2360	2369	2449	2511	2599	2706
VDB243421	1633	1557	1584	1638	1650	1678	1735	1742	1801	1845	1911	1987
VDB273421	1763	1682	1711	1769	1782	1810	1874	1881	1945	1994	2063	2147
VDB303421	1903	1816	1849	1911	1925	1956	2024	2032	2100	2152	2230	2318
VDB333421	2056	1961	1997	2063	2079	2112	2185	2192	2268	2326	2409	2505
VDB363421	2220	2119	2156	2230	2245	2282	2360	2369	2449	2511	2599	2706

**Custom Modifications**

AUTHL	AUTHR	CBO	CCO	CFNTO	CFP	CFRMO	CMAT	CND	DRWPWR	DRWTK	EXBKL	EXBKR	EXL	EXR	FB	FFDL	FFDR	FPEB	FTK	FTKAV	FTKRV	ID	INVFRM	LTI	MIP	RD	RECTKALL	RECTKLBK	RECTKL	RECTKR	RT	TKP	TOTSSS	VTK	WLI
•	•	•	•	•	•	•	•	•	•*	•*	•	•	•	•	•	•	•	•	•	•	•	•	•	•	•	•	•	•	•	•	•	•	•	•	•

\*Not available on 12" and 15" wide    \*Not available on 12" and 15" wide, or on 18" deep    †Not available on 12" wide

**Construction Upgrades**

APC	PE
•	•

**Door Options**

ALF	CG	DPSRR	MD	MFO
•	•	•	•	•



**VANITY WASTEBASKET FULL HEIGHT with ROLL TRAY, 32" HIGH, 21" DEEP**

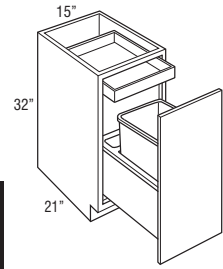

Model	1	2	3	4	5	6
VWB153221RT	1347	1374	1430	1473	1492	1522

- Includes one 35 quart gray wastebasket and one trash bag storage area.
- Pull-out features undermount Smart Stop guides.
- 1 roll tray standard.
- Not compatible with BWBLID due to limited height clearance.

Model	7	8	9	10	11	12	13	14	15	16	17	18
VWB153221RT	1525	1559	1571	1596	1603	1613	1640	1644	1675	1691	1722	1753

**Custom Modifications**

AUTHL	CBO	CCO	CFNTO	CFP	CFRMO	CMAT	CND	DRWPWR	DRWTK	EXBKL	EXL	FB	FFDL	FPEB	FTK	FTKAV	ID	INVFRM	LTI	MIP	RD	RECTKALL	RECTKLBK	RECTKLR	RT	TKP	TOTSSS	VTK	WLI	
•	•	•								•	•	•		•	•	•					•		•	•					•	•

**Construction Upgrades**

APC	PE
•	•

**Door Options**

ALF	CG	DPSRR	MD	MFO

**VANITY WASTEBASKET FULL HEIGHT, 34 1/2" HIGH, 21" DEEP**

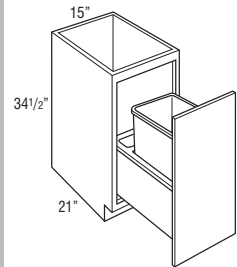

Model	1098	1125	1184	1222	1242	1277
VWB153421						

- Includes one 35 quart gray wastebasket and one trash bag storage area.
- Pull-out features undermount Smart Stop guides.
- Base Wastebasket Lid (BWBLID) fits 35 quart wastebaskets. See page 579.

Model	1279	1317	1327	1353	1359	1374	1402	1404	1437	1458	1492	1526
VWB153421												

**Custom Modifications**

AUTHL	CBO	CCO	CFNTO	CFP	CFRMO	CMAT	CND	DRWPWR	DRWTK	EXBKL	EXL	FB	FFDL	FPEB	FTK	FTKAV	ID	INVFRM	LTI	MIP	RD	RECTKALL	RECTKLBK	RECTKLR	RT	TKP	TOTSSS	VTK	WLI	
•	•	•								•	•	•		•	•	•					•		•	•					•	•

**Construction Upgrades**

APC	PE
•	•

**Door Options**

ALF	CG	DPSRR	MD	MFO

**VANITY WASTEBASKET FULL HEIGHT with ROLL TRAY, 34 1/2" HIGH, 21" DEEP**

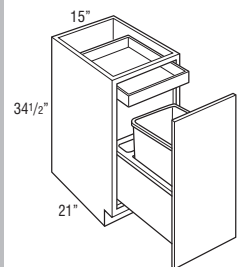

Model	1382	1409	1468	1506	1526	1561
VWB153421RT						

- Includes one 35 quart gray wastebasket and one trash bag storage area.
- Pull-out features undermount Smart Stop guides.
- 1 roll tray standard.
- Base Wastebasket Lid (BWBLID) fits 35 quart wastebaskets. See page 579.

Model	1563	1601	1611	1637	1643	1658	1686	1688	1721	1742	1776	1810
VWB153421RT												

**Custom Modifications**

AUTHL	CBO	CCO	CFNTO	CFP	CFRMO	CMAT	CND	DRWPWR	DRWTK	EXBKL	EXL	FB	FFDL	FPEB	FTK	FTKAV	ID	INVFRM	LTI	MIP	RD	RECTKALL	RECTKLBK	RECTKLR	RT	TKP	TOTSSS	VTK	WLI	
•	•	•								•	•	•		•	•	•					•		•	•					•	•

**Construction Upgrades**

APC	PE
•	•

**Door Options**

ALF	CG	DPSRR	MD	MFO

**VANITY PULL-OUT, 34 1/2" HIGH, 21" DEEP**

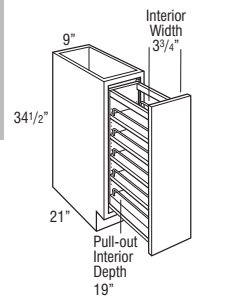

Model	818	871	968	980	1009	1046
VP93421						

- Natural Finish with Smart Stop full extension wood pull-out with adjustable shelves and chrome rail sides.
- Pull-out is 19 9/16" deep.

Model	1078	1107	1132	1175	1186	1212	1259	1264	1316	1350	1407	1464
VP93421												

**Custom Modifications**

AUTHL	CBO	CCO	CFNTO	CFP	CFRMO	CMAT	CND	DRWPWR	DRWTK	EXBKL	EXL	FB	FFDL	FPEB	FTK	FTKAV	ID	INVFRM	LTI	MIP	RD	RECTKALL	RECTKLBK	RECTKLR	RT	TKP	TOTSSS	VTK	WLI	
•	•	•								•	•	•		•	•	•					•		•*	•					•	•

\*RECTKALL not available

**Construction Upgrades**

APC	PE
•	•

**Door Options**

ALF	CG	DPSRR	MD	MFO
		•		

**VANITY GROOMING PULL-OUT, 34 1/2" HIGH, 21" DEEP**

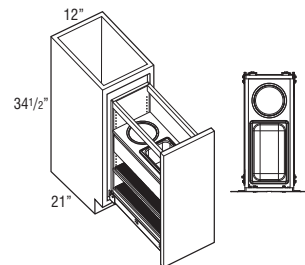

Model	1894	1956	2049	2067	2104	2137
VGPO123421						

- Natural Finish with Smart Stop full extension wood pull-out with adjustable shelves and chrome rail sides.
- Pull-out is 19 9/16" deep.
- Features adjustable shelves with non-skid vinyl liners and clear polycarbonate rails.
- Includes two stainless steel bins (one rectangular and one round) for storing items such as curling irons and hair dryers.

Model	2171	2204	2225	2274	2286	2310	2361	2371	2427	2461	2522	2583
VGPO123421												

**Custom Modifications**

AUTHL	CBO	CCO	CFNTO	CFP	CFRMO	CMAT	CND	DRWPWR	DRWTK	EXBKL	EXL	FB	FFDL	FPEB	FTK	FTKAV	ID	INVFRM	LTI	MIP	RD	RECTKALL	RECTKLBK	RECTKLR	RT	TKP	TOTSSS	VTK	WLI	
•	•	•								•	•	•		•	•	•					•		•	•					•	•

**Construction Upgrades**

APC	PE
•	•

**Door Options**

ALF	CG	DPSRR	MD	MFO
		•		

**VANITY SINK DRAWER BASE,  
32" HIGH, 18" or 21" DEEP**

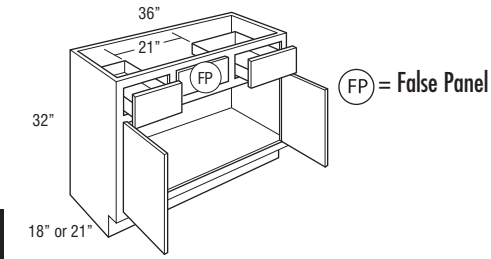

2VSD363218  
2VSD363221

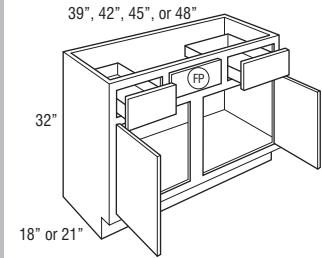

2VSD393218 2VSD393221  
2VSD423218 2VSD423221  
2VSD453218 2VSD453221  
2VSD483218CS 2VSD483221CS

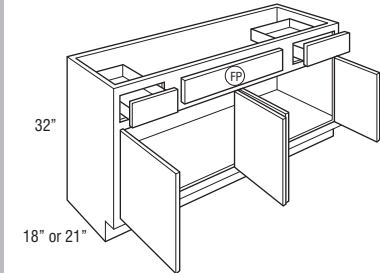

2VSD483218  
2VSD483221

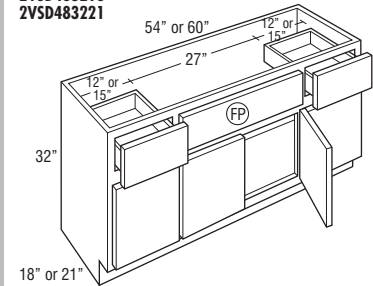

2VSD543218FP 2VSD543221FP  
2VSD603218FP 2VSD603221FP

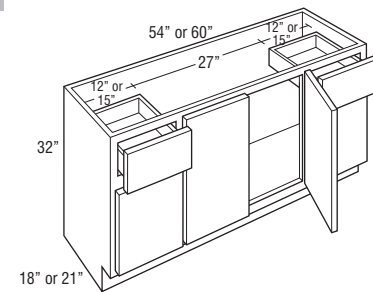

2VSD543218 2VSD543221  
2VSD603218 2VSD603221

Model	1	2	3	4	5	6
2VSD363218	1160	1209	1305	1345	1345	1345
2VSD363221	1160	1209	1305	1345	1345	1345
<b>NEW</b> 2VSD393218	1176	1228	1334	1408	1408	1408
2VSD423218	1192	1247	1363	1470	1470	1470
2VSD453218	1217	1273	1424	1541	1518	1522
2VSD483218CS	1243	1300	1488	1609	1566	1575
<b>NEW</b> 2VSD393221	1176	1228	1334	1408	1408	1408
2VSD423221	1192	1247	1363	1470	1470	1470
2VSD453221	1217	1273	1424	1541	1518	1522
2VSD483221CS	1243	1300	1488	1609	1566	1575
2VSD483218	1293	1354	1610	1749	1662	1681
2VSD483221	1293	1354	1610	1749	1662	1681
2VSD543218FP	1592	1669	2010	2198	2096	2161
2VSD603218FP	1715	1801	2176	2378	2275	2359
2VSD543221FP	1592	1669	2010	2198	2096	2161
2VSD603221FP	1715	1801	2176	2378	2275	2359
2VSD543218	1431	1503	1798	1957	1869	1902
2VSD603218	1541	1614	1941	2118	2028	2075
2VSD543221	1431	1503	1798	1957	1869	1902
2VSD603221	1541	1614	1941	2118	2028	2075

	Face Frame Opening Width			Available Sink Clearance Width	# of Sink Openings	# of Drawers
	Drawers	Side Doors	False Panel			
2VSD36...	6"	33" (butt doors)	15"	21"	1	2
2VSD39...	7 1/2"	16 1/2"	15"	21"	1	2
2VSD42...	9"	18"	15"	21"	1	2
2VSD45...	9"	19 1/2"	18"	24"	1	2
2VSD48...CS	12"	21"	15"	21"	1	2
2VSD48...	12"	21"	15"	21"	1	2
2VSD54...	12"	12"	21"	27"	1	2
2VSD60...	15"	15"	21"	27"	1	2

Model	7	8	9	10	11	12	13	14	15	16	17	18
2VSD363218	1480	1416	1441	1492	1502	1528	1582	1592	1649	1690	1751	1824
2VSD363221	1480	1416	1441	1492	1502	1528	1582	1592	1649	1690	1751	1824
2VSD393218	1549	1483	1509	1563	1574	1602	1659	1668	1728	1771	1837	1912
2VSD423218	1617	1549	1576	1633	1646	1676	1736	1744	1807	1852	1922	2000
2VSD453218	1674	1604	1633	1692	1706	1736	1800	1806	1875	1921	1994	2074
2VSD483218CS	1731	1659	1690	1751	1765	1797	1861	1870	1940	1986	2063	2146
2VSD393221	1549	1483	1509	1563	1574	1602	1659	1668	1728	1771	1837	1912
2VSD423221	1617	1549	1576	1633	1646	1676	1736	1744	1807	1852	1922	2000
2VSD453221	1674	1604	1633	1692	1706	1736	1800	1806	1875	1921	1994	2074
2VSD483221CS	1731	1659	1690	1751	1765	1797	1861	1870	1940	1986	2063	2146
2VSD483218	1844	1769	1802	1868	1883	1917	1986	1998	2073	2124	2205	2293
2VSD483221	1844	1769	1802	1868	1883	1917	1986	1998	2073	2124	2205	2293
2VSD543218FP	2417	2280	2321	2410	2430	2476	2564	2578	2676	2742	2850	2965
2VSD603218FP	2614	2489	2536	2634	2652	2703	2800	2819	2928	3000	3120	3246
2VSD543221FP	2417	2280	2321	2410	2430	2476	2564	2578	2676	2742	2850	2965
2VSD603221FP	2614	2489	2536	2634	2652	2703	2800	2819	2928	3000	3120	3246
2VSD543218	2092	2006	2042	2118	2134	2176	2253	2263	2351	2410	2503	2604
2VSD603218	2329	2188	2229	2311	2330	2375	2462	2473	2568	2634	2734	2843
2VSD543221	2092	2006	2042	2118	2134	2176	2253	2263	2351	2410	2503	2604
2VSD603221	2329	2188	2229	2311	2330	2375	2462	2473	2568	2634	2734	2843

**Custom Modifications**

AUTHL	AUTHR	CBO	CCO	CFNTO	CFP	CFRMO	CMAT	CND	DRWPWR	DRWTK	EXBKL	EXBKR	EXL	EXR	FB	FFDL	FFDR	FPEB	FTK	FTKAV	FTKVV	ID	INFRM	LTI	MIP	RD	RECTKALL	RECTKLBK	RECTKLR	RECTKR	RT	TKP	TOTSSS	VTK	WLI
•	•	•	•	•	•	•	•	•	•	•	•	•	•	•	•	•	•	•	•	•	•	•	•	•	•	•	•	•	•	•	•	•	•	•	•

\*Not available on 39", 42", and 45" wide, or on 18" deep \*Available only on 60" wide \*Available only on 2VSD363221 †Available only on 36", 39", 42", 45", and 48" wide ‡Available only on cabinets with false panels

**Construction Upgrades**

APC	PE
•	•

**Door Options**

ALF	CG	DPSRR	MD	MFO
		•		



**VANITY SINK DRAWER BASE,  
34 1/2" HIGH, 18" or 21" DEEP**

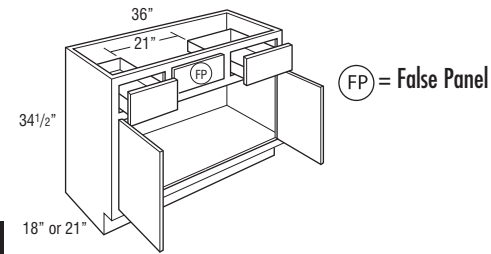

2VSD363418  
2VSD363421

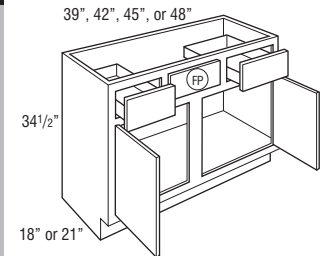

2VSD393418  
2VSD423418  
2VSD453418  
2VSD483418CS

2VSD393421  
2VSD423421  
2VSD453421  
2VSD483421CS

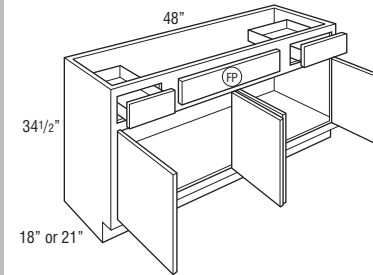

2VSD483418  
2VSD483421

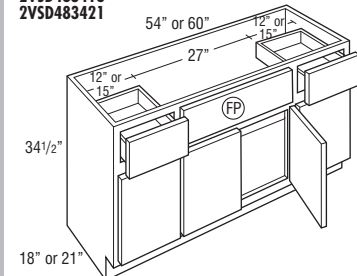

2VSD543418FP  
2VSD603418FP

2VSD543421FP  
2VSD603421FP

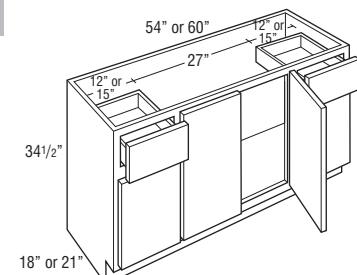

2VSD543418  
2VSD603418

2VSD543421  
2VSD603421

Model	1	2	3	4	5	6
2VSD363418	1275	1334	1445	1518	1518	1518
2VSD363421	1275	1334	1445	1518	1518	1518
<b>NEW</b> 2VSD393418	1295	1356	1477	1600	1588	1590
2VSD423418	1314	1378	1509	1681	1658	1661
2VSD453418	1344	1412	1582	1750	1710	1722
2VSD483418CS	1373	1442	1655	1818	1762	1783
<b>NEW</b> 2VSD393421	1295	1356	1477	1600	1588	1590
2VSD423421	1314	1378	1509	1681	1658	1661
2VSD453421	1344	1412	1582	1750	1710	1722
2VSD483421CS	1373	1442	1655	1818	1762	1783
2VSD483418	1431	1503	1798	1956	1868	1903
2VSD483421	1431	1503	1798	1956	1868	1903
2VSD543418FP	1772	1864	2257	2471	2366	2456
2VSD603418FP	1912	2012	2441	2677	2571	2683
2VSD543421FP	1772	1864	2257	2471	2366	2456
2VSD603421FP	1912	2012	2441	2677	2571	2683
2VSD543418	1592	1669	2010	2200	2105	2157
2VSD603418	1711	1800	2175	2378	2287	2356
2VSD543421	1592	1669	2010	2200	2105	2157
2VSD603421	1711	1800	2175	2378	2287	2356

	Face Frame Opening Width			Available Sink Clearance Width	# of Sink Openings	# of Drawers
	Drawers	Side Doors	False Panel			
2VSD36...	6"	33" (butt doors)	15"	21"	1	2
2VSD39...	7 1/2"	16 1/2"	15"	21"	1	2
2VSD42...	9"	18"	15"	21"	1	2
2VSD45...	9"	19 1/2"	18"	24"	1	2
2VSD48...CS	12"	21"	15"	21"	1	2
2VSD48...	12"	21"	15"	21"	1	2
2VSD54...	12"	12"	21"	27"	1	2
2VSD60...	15"	15"	21"	27"	1	2

Model	7	8	9	10	11	12	13	14	15	16	17	18
2VSD363418	1669	1602	1627	1687	1700	1732	1796	1801	1868	1914	1987	2067
2VSD363421	1669	1602	1627	1687	1700	1732	1796	1801	1868	1914	1987	2067
2VSD393418	1759	1677	1706	1768	1781	1814	1880	1888	1960	2007	2084	2167
2VSD423418	1849	1752	1784	1849	1861	1896	1963	1975	2051	2099	2180	2267
2VSD453418	1910	1816	1850	1917	1931	1966	2036	2047	2127	2178	2262	2352
2VSD483418CS	1972	1881	1914	1983	2001	2036	2108	2121	2202	2255	2343	2436
2VSD393421	1759	1677	1706	1768	1781	1814	1880	1888	1960	2007	2084	2167
2VSD423421	1849	1752	1784	1849	1861	1896	1963	1975	2051	2099	2180	2267
2VSD453421	1910	1816	1850	1917	1931	1966	2036	2047	2127	2178	2262	2352
2VSD483421CS	1972	1881	1914	1983	2001	2036	2108	2121	2202	2255	2343	2436
2VSD483418	2093	2007	2045	2119	2136	2177	2255	2264	2352	2411	2505	2605
2VSD483421	2093	2007	2045	2119	2136	2177	2255	2264	2352	2411	2505	2605
2VSD543418FP	2718	2591	2641	2738	2763	2814	2919	2931	3047	3125	3249	3378
2VSD603418FP	2945	2833	2886	2997	3019	3079	3192	3207	3337	3420	3554	3697
2VSD543421FP	2718	2591	2641	2738	2763	2814	2919	2931	3047	3125	3249	3378
2VSD603421FP	2945	2833	2886	2997	3019	3079	3192	3207	3337	3420	3554	3697
2VSD543418	2419	2275	2319	2405	2425	2470	2561	2571	2673	2738	2847	2962
2VSD603418	2614	2485	2533	2629	2646	2699	2797	2814	2924	2997	3115	3239
2VSD543421	2419	2275	2319	2405	2425	2470	2561	2571	2673	2738	2847	2962
2VSD603421	2614	2485	2533	2629	2646	2699	2797	2814	2924	2997	3115	3239

**Custom Modifications**

AUTHL	AUTHR	CBO	CCO	CFNTO	CFP	CFRMO	CMAT	CND	DRWPWR	DRWTK	EXBKL	EXBKR	EXL	EXR	FB	FFDL	FFDR	FPEB	FTK	FTKAV	FTKFV	ID	INFRM	LT	MIP	RD	RECTKALL	RECTKBK	RECTKL	RECTKR	RT	TKP	TOTSS	VTK	WLI
•	•	•	•	•	•	•	•	•	•	•	•	•	•	•	•	•	•	•	•	•	•	•	•	•	•	•	•	•	•	•	•	•	•	•	•

\*Not available on 39", 42", and 45" wide, or on 18" deep \*Available only on 60" wide \*Available only on 2VSD363421 †Available only on 36", 39", 42", 45", and 48" wide ‡Available only on cabinets with false panels

**Construction Upgrades**

APC	PE
•	•

**Door Options**

ALF	CG	DPSRR	MD	MFO
		•		

**VANITY SINK DRAWER BASE,  
32" HIGH, 18" or 21" DEEP**

24", 27", 30", or 33"

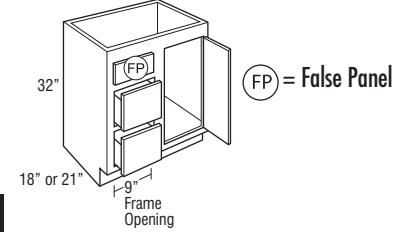

FP = False Panel

VSD243218 DL or DR VSD243221 DL or DR  
VSD273218 DL or DR VSD273221 DL or DR  
VSD303218 DL or DR VSD303221 DL or DR  
VSD333218 DL or DR VSD333221 DL or DR

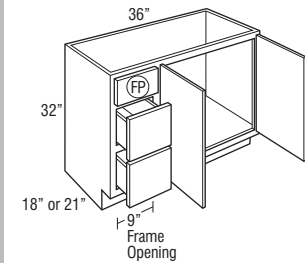

VSD363218 DL or DR VSD363221 DL or DR

39", 42", 45", or 48"

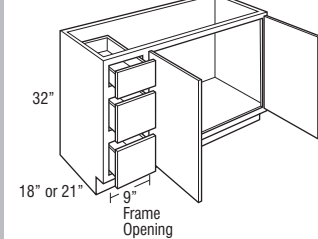

VSD393218 DL or DR VSD393221 DL or DR  
VSD423218 DL or DR VSD423221 DL or DR  
VSD453218 DL or DR VSD453221 DL or DR  
VSD483218 DL or DR VSD483221 DL or DR

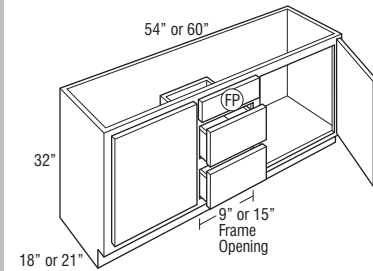

VSD543218 VSD543221  
VSD603218 VSD603221

Model	1	2	3	4	5	6
VSD243218 DL or DR	1121	1169	1200	1256	1256	1256
VSD273218 DL or DR	1249	1308	1353	1454	1454	1454
VSD303218 DL or DR	1150	1202	1252	1316	1316	1316
VSD333218 DL or DR	1209	1266	1320	1407	1407	1407
VSD243221 DL or DR	1121	1169	1200	1256	1256	1256
VSD273221 DL or DR	1136	1186	1225	1286	1286	1286
VSD303221 DL or DR	1150	1202	1252	1316	1316	1316
VSD333221 DL or DR	1209	1266	1320	1407	1407	1407

VSD363218 DL or DR	1267	1327	1388	1501	1501	1501
VSD363221 DL or DR	1267	1327	1388	1501	1501	1501

<b>NEW</b> VSD393218 DL or DR	1382	1442	1512	1583	1583	1583
VSD423218 DL or DR	1497	1557	1635	1664	1664	1664
VSD453218 DL or DR	1521	1583	1665	1706	1706	1706
VSD483218 DL or DR	1546	1607	1694	1747	1747	1747
<b>NEW</b> VSD393221 DL or DR	1382	1442	1512	1583	1583	1583
VSD423221 DL or DR	1497	1557	1635	1664	1664	1664
VSD453221 DL or DR	1521	1583	1665	1706	1706	1706
VSD483221 DL or DR	1546	1607	1694	1747	1747	1747

VSD543218	1544	1613	1715	1867	1809	1822
VSD603218	1541	1616	1734	1986	1874	1897
VSD543221	1544	1613	1715	1867	1809	1822
VSD603221	1541	1616	1734	1986	1874	1897

- DL or DR indicates drawer location.
- CFP is available on 39", 42", 45", and 48" widths, but standard on all other widths.

	Face Frame Opening Width		Available Sink Clearance Width	# of Sink Openings	# of Drawers
	Drawers	Doors			
VSD24...	9"	9"	21"	1	2
VSD27...	9"	12"	24"	1	2
VSD30...	9"	15"	27"	1	2
VSD33...	9"	18"	30"	1	2
VSD36...	9"	21"	33"	1	2
VSD39...	9"	24"	27"	1	3
VSD42...	9"	27"	30"	1	1
VSD45...	9"	30"	33"	1	1
VSD48...	9"	33"	36"	1	1
VSD54...	9"	18"	21"	2	2
VSD60...	15"	18"	21"	2	2

Model	7	8	9	10	11	12	13	14	15	16	17	18
VSD243218 DL or DR	1382	1320	1344	1392	1400	1429	1479	1484	1540	1575	1635	1700
VSD273218 DL or DR	1600	1530	1557	1613	1626	1656	1715	1721	1787	1832	1900	1976
VSD303218 DL or DR	1448	1388	1407	1457	1470	1497	1550	1556	1613	1654	1714	1783
VSD333218 DL or DR	1549	1482	1508	1560	1575	1603	1660	1666	1728	1772	1838	1911
VSD243221 DL or DR	1382	1320	1344	1392	1400	1429	1479	1484	1540	1575	1635	1700
VSD273221 DL or DR	1416	1353	1376	1425	1436	1463	1514	1520	1576	1614	1675	1743
VSD303221 DL or DR	1448	1388	1407	1457	1470	1497	1550	1556	1613	1654	1714	1783
VSD333221 DL or DR	1549	1482	1508	1560	1575	1603	1660	1666	1728	1772	1838	1911

VSD363218 DL or DR	1650	1578	1607	1664	1680	1709	1769	1777	1843	1892	1960	2039
VSD363221 DL or DR	1650	1578	1607	1664	1680	1709	1769	1777	1843	1892	1960	2039

VSD393218 DL or DR	1741	1663	1694	1752	1767	1798	1861	1868	1937	1986	2057	2140
VSD423218 DL or DR	1832	1748	1781	1840	1853	1887	1953	1958	2031	2079	2153	2241
VSD453218 DL or DR	1878	1794	1825	1887	1900	1935	2001	2008	2083	2132	2209	2298
VSD483218 DL or DR	1922	1838	1867	1932	1948	1981	2048	2058	2134	2184	2264	2354
VSD393221 DL or DR	1741	1663	1694	1752	1767	1798	1861	1868	1937	1986	2057	2140
VSD423221 DL or DR	1832	1748	1781	1840	1853	1887	1953	1958	2031	2079	2153	2241
VSD453221 DL or DR	1878	1794	1825	1887	1900	1935	2001	2008	2083	2132	2209	2298
VSD483221 DL or DR	1922	1838	1867	1932	1948	1981	2048	2058	2134	2184	2264	2354

VSD543218	2005	1921	1952	2023	2039	2075	2148	2158	2238	2294	2380	2474
VSD603218	2088	2002	2036	2111	2130	2166	2249	2256	2343	2403	2494	2594
VSD543221	2005	1921	1952	2023	2039	2075	2148	2158	2238	2294	2380	2474
VSD603221	2088	2002	2036	2111	2130	2166	2249	2256	2343	2403	2494	2594

**Custom Modifications**

AUTHL	CBO	CCO	CFNTO	CFP	CFRMO	CMAT	CND	DRWPWR	DRWTK	EXBKL	EXL	EXR	FB	FFDL	FPEB	FTK	FTKAV	FTKRV	ID	INVFRM	LTI	MIP	RD	RECTKALL	RECTKLBK	RECTKLBK	RECTKLBK	RECTKR	RT	TKP	TOTSSS	VTK	WLI	
•	•	•		STD	•	•*	•		•*	•	•	•	•	•	•	•	•	•	•	•	•*	•	•	•	•	•	•	•	•	•	•	•	•	•

\*Not available on 24", 27", 30", 33", and 60" wide, or on 18" deep \*Not available on 39", 42", 45", 48", 54" and 60" wide, or on 18" deep \*Not available on 24" wide

**Construction Upgrades**

APC	PE
•	•

**Door Options**

ALF	CG	DPSRR	MD	MFO
		•		

**VANITY SINK DRAWER BASE,  
34 1/2" HIGH, 18" or 21" DEEP**

24", 27", 30", or 33" (FP) = False Panel

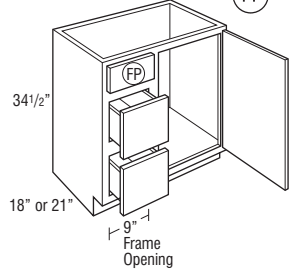

VSD243418 DL or DR VSD243421 DL or DR  
 VSD273418 DL or DR VSD273421 DL or DR  
 VSD303418 DL or DR VSD303421 DL or DR  
 VSD333418 DL or DR VSD333421 DL or DR

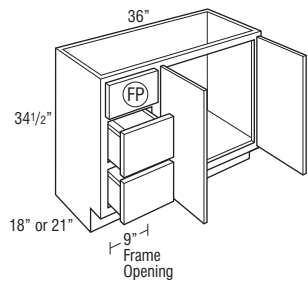

VSD363418 DL or DR  
 VSD363421 DL or DR

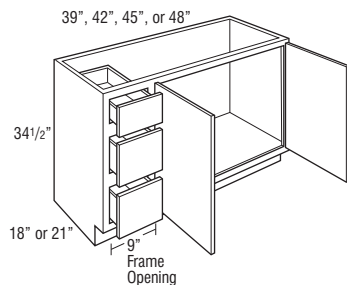

VSD393418 DL or DR VSD393421 DL or DR  
 VSD423418 DL or DR VSD423421 DL or DR  
 VSD453418 DL or DR VSD453421 DL or DR  
 VSD483418 DL or DR VSD483421 DL or DR

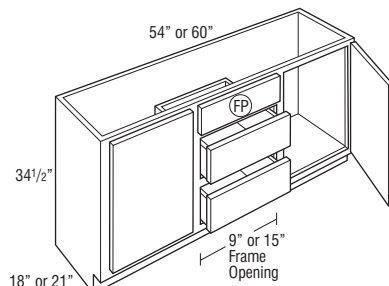

VSD543418 VSD543421  
 VSD603418 VSD603421

Model	1	2	3	4	5	6
VSD243418 DL or DR	1231	1287	1325	1419	1419	1419
VSD273418 DL or DR	1250	1309	1353	1454	1454	1454
VSD303418 DL or DR	1268	1329	1384	1491	1491	1491
VSD333418 DL or DR	1334	1397	1462	1623	1590	1592
VSD243421 DL or DR	1231	1287	1325	1419	1419	1419
VSD273421 DL or DR	1250	1309	1353	1454	1454	1454
VSD303421 DL or DR	1268	1329	1384	1491	1491	1491
VSD333421 DL or DR	1334	1397	1462	1623	1590	1592

VSD363418 DL or DR	1399	1465	1542	1753	1689	1691
VSD363421 DL or DR	1399	1465	1542	1753	1689	1691

<b>NEW</b> VSD393418 DL or DR	1520	1585	1669	1810	1778	1779
-------------------------------	------	------	------	------	------	------

VSD423418 DL or DR	1640	1705	1796	1867	1867	1867
VSD453418 DL or DR	1667	1735	1830	1918	1918	1918

<b>NEW</b> VSD393421 DL or DR	1520	1585	1669	1810	1778	1779
-------------------------------	------	------	------	------	------	------

VSD423421 DL or DR	1640	1705	1796	1867	1867	1867
VSD453421 DL or DR	1667	1735	1830	1918	1918	1918
VSD483421 DL or DR	1693	1766	1863	1968	1968	1968

VSD543418	1703	1785	1901	2097	2042	2060
VSD603418	1711	1802	1938	2226	2116	2152
VSD543421	1703	1785	1901	2097	2042	2060
VSD603421	1711	1802	1938	2226	2116	2152

- DL or DR indicates drawer location.
- CFP is available on 39", 42", 45", and 48" widths, but standard on all other widths.

	Face Frame Opening Width		Available Sink Clearance Width	# of Sink Openings	# of Drawers
	Drawers	Doors			
VSD24...	9"	9"	21"	1	2
VSD27...	9"	12"	24"	1	2
VSD30...	9"	15"	27"	1	2
VSD33...	9"	18"	30"	1	2
VSD36...	9"	21"	33"	1	2
VSD39...	9"	24"	27"	1	3
VSD42...	9"	27"	30"	1	1
VSD45...	9"	30"	33"	1	1
VSD48...	9"	33"	36"	1	1
VSD54...	9"	18"	21"	2	2
VSD60...	15"	18"	21"	2	2

Model	7	8	9	10	11	12	13	14	15	16	17	18
VSD243418 DL or DR	1559	1494	1518	1574	1584	1613	1668	1680	1743	1783	1850	1923
VSD273418 DL or DR	1600	1532	1557	1614	1625	1655	1712	1721	1787	1831	1898	1974
VSD303418 DL or DR	1640	1567	1597	1654	1665	1696	1755	1765	1832	1875	1948	2025
VSD333418 DL or DR	1748	1675	1704	1766	1781	1810	1879	1886	1956	2006	2082	2165
VSD243421 DL or DR	1559	1494	1518	1574	1584	1613	1668	1680	1743	1783	1850	1923
VSD273421 DL or DR	1600	1532	1557	1614	1625	1655	1712	1721	1787	1831	1898	1974
VSD303421 DL or DR	1640	1567	1597	1654	1665	1696	1755	1765	1832	1875	1948	2025
VSD333421 DL or DR	1748	1675	1704	1766	1781	1810	1879	1886	1956	2006	2082	2165

VSD363418 DL or DR	1855	1781	1810	1879	1894	1927	2000	2005	2082	2134	2216	2305
VSD363421 DL or DR	1855	1781	1810	1879	1894	1927	2000	2005	2082	2134	2216	2305

VSD393418 DL or DR	1955	1873	1905	1974	1991	2025	2099	2105	2185	2236	2321	2414
--------------------	------	------	------	------	------	------	------	------	------	------	------	------

VSD423418 DL or DR	2055	1964	2000	2068	2087	2122	2198	2205	2287	2338	2426	2523
VSD453418 DL or DR	2110	2019	2054	2127	2143	2181	2257	2266	2350	2405	2495	2594

VSD483418 DL or DR	2165	2074	2108	2183	2201	2240	2316	2328	2414	2472	2563	2666
--------------------	------	------	------	------	------	------	------	------	------	------	------	------

VSD393421 DL or DR	1955	1873	1905	1974	1991	2025	2099	2105	2185	2236	2321	2414
--------------------	------	------	------	------	------	------	------	------	------	------	------	------

VSD423421 DL or DR	2055	1964	2000	2068	2087	2122	2198	2205	2287	2338	2426	2523
--------------------	------	------	------	------	------	------	------	------	------	------	------	------

VSD453421 DL or DR	2110	2019	2054	2127	2143	2181	2257	2266	2350	2405	2495	2594
--------------------	------	------	------	------	------	------	------	------	------	------	------	------

VSD483421 DL or DR	2165	2074	2108	2183	2201	2240	2316	2328	2414	2472	2563	2666
--------------------	------	------	------	------	------	------	------	------	------	------	------	------

VSD543418	2266	2173	2211	2291	2308	2351	2436	2445	2539	2604	2702	2810
VSD603418	2367	2270	2313	2397	2417	2463	2556	2564	2665	2733	2839	2953
VSD543421	2266	2173	2211	2291	2308	2351	2436	2445	2539	2604	2702	2810
VSD603421	2367	2270	2313	2397	2417	2463	2556	2564	2665	2733	2839	2953

**Custom Modifications**

AUTHL	CBO	CCO	CFNTO	CFP	CFRMO	CMAT	CND	DRWPWR	DRWTK	EXBKL	EXL	EXR	FB	FFDL	FPEB	FTK	FTKAV	ID	INFRM	LTI	MIP	RD	RECTKALL	RECTKLBK	RECTKLR	RT	TKP	TOTSSS	VTK	WLI
•	•	•		STD	•	•*	•		•*	•	•	•	•	•	•	•	•	•	•	•*	•	•	•	•	•	•	•	•	•	•

\*Not available on 24", 27", 30", 33", and 60" wide, or on 18" deep \*Not available on 39", 42", 45", 48", 54" and 60" wide, or on 18" deep \*Not available on 24" wide

**Construction Upgrades**

APC	PE
•	•

**Door Options**

ALF	CG	DPSRR	MD	MFO
		•		

**VANITY SINK DRAWER BASE with FALSE PANELS, 32" HIGH, 18" or 21" DEEP**

24", 27", 30", or 33"

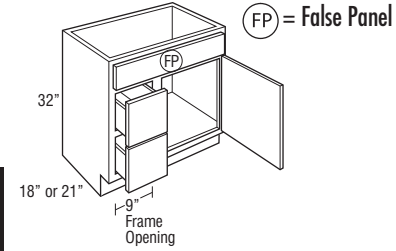

VSD243218FP DL or DR VSD243221FP DL or DR  
 VSD273218FP DL or DR VSD273221FP DL or DR  
 VSD303218FP DL or DR VSD303221FP DL or DR  
 VSD333218FP DL or DR VSD333221FP DL or DR

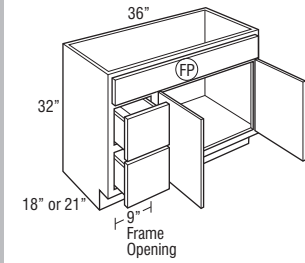

VSD363218FP DL or DR  
 VSD363221FP DL or DR

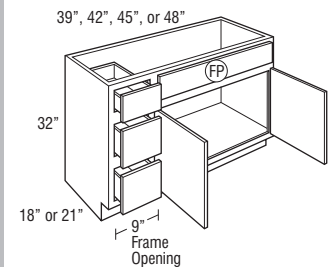

VSD393218FP DL or DR VSD393221FP DL or DR  
 VSD423218FP DL or DR VSD423221FP DL or DR  
 VSD453218FP DL or DR VSD453221FP DL or DR  
 VSD483218FP DL or DR VSD483221FP DL or DR

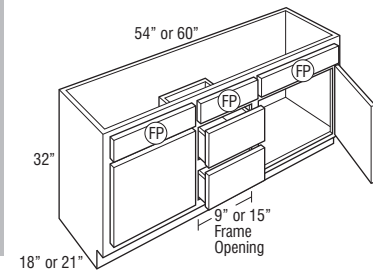

VSD543218FP VSD543221FP  
 VSD603218FP VSD603221FP

Model	1	2	3	4	5	6
VSD243218FP DL or DR	1229	1287	1324	1420	1420	1420
VSD273218FP DL or DR	1249	1308	1353	1454	1454	1454
VSD303218FP DL or DR	1267	1327	1384	1490	1490	1490
VSD333218FP DL or DR	1334	1397	1461	1622	1583	1595
VSD243221FP DL or DR	1229	1287	1324	1420	1420	1420
VSD273221FP DL or DR	1249	1308	1353	1454	1454	1454
VSD303221FP DL or DR	1267	1327	1384	1490	1490	1490
VSD333221FP DL or DR	1334	1397	1461	1622	1583	1595

VSD363218FP DL or DR	1400	1469	1540	1752	1678	1699
VSD363221FP DL or DR	1400	1469	1540	1752	1678	1699

<b>NEW</b> VSD393218FP DL or DR	1520	1588	1668	1815	1778	1788
---------------------------------	------	------	------	------	------	------

VSD423218FP DL or DR	1639	1707	1796	1877	1877	1877
----------------------	------	------	------	------	------	------

VSD453218FP DL or DR	1666	1738	1830	1923	1923	1923
----------------------	------	------	------	------	------	------

VSD483218FP DL or DR	1692	1767	1863	1968	1968	1968
----------------------	------	------	------	------	------	------

<b>NEW</b> VSD393221FP DL or DR	1520	1588	1668	1815	1778	1788
---------------------------------	------	------	------	------	------	------

VSD423221FP DL or DR	1639	1707	1796	1877	1877	1877
----------------------	------	------	------	------	------	------

VSD453221FP DL or DR	1666	1738	1830	1923	1923	1923
----------------------	------	------	------	------	------	------

VSD483221FP DL or DR	1692	1767	1863	1968	1968	1968
----------------------	------	------	------	------	------	------

VSD543218FP	1704	1785	1901	2098	2035	2061
-------------	------	------	------	------	------	------

VSD603218FP	1715	1802	1938	2228	2100	2154
-------------	------	------	------	------	------	------

VSD543221FP	1704	1785	1901	2098	2035	2061
-------------	------	------	------	------	------	------

VSD603221FP	1715	1802	1938	2228	2100	2154
-------------	------	------	------	------	------	------

- DL or DR indicates drawer location.
- CFP is available on 42", 45", and 48" widths, but standard on all other widths.

	Face Frame Opening Width		Available Sink Clearance Width	# of Sink Openings	# of Drawers
	Drawers	Doors			
VSD24...	9"	9"	21"	1	2
VSD27...	9"	12"	24"	1	2
VSD30...	9"	15"	27"	1	2
VSD33...	9"	18"	30"	1	2
VSD36...	9"	21"	33"	1	2
VSD39...	9"	24"	27"	1	3
VSD42...	9"	27"	30"	1	1
VSD45...	9"	30"	33"	1	1
VSD48...	9"	33"	36"	1	1
VSD54...	9"	18"	21"	2	2
VSD60...	15"	18"	21"	2	2

Model	7	8	9	10	11	12	13	14	15	16	17	18
VSD243218FP DL or DR	1560	1494	1518	1574	1588	1616	1675	1681	1744	1786	1853	1926
VSD273218FP DL or DR	1600	1530	1557	1613	1626	1656	1715	1721	1787	1832	1900	1976
VSD303218FP DL or DR	1638	1566	1596	1651	1664	1696	1754	1762	1831	1875	1948	2025
VSD333218FP DL or DR	1752	1680	1710	1770	1785	1818	1883	1890	1961	2011	2089	2173
VSD243221FP DL or DR	1560	1494	1518	1574	1588	1616	1675	1681	1744	1786	1853	1926
VSD273221FP DL or DR	1600	1530	1557	1613	1626	1656	1715	1721	1787	1832	1900	1976
VSD303221FP DL or DR	1638	1566	1596	1651	1664	1696	1754	1762	1831	1875	1948	2025
VSD333221FP DL or DR	1752	1680	1710	1770	1785	1818	1883	1890	1961	2011	2089	2173

VSD363218FP DL or DR	1867	1792	1825	1889	1906	1941	2008	2014	2093	2147	2230	2318
VSD363221FP DL or DR	1867	1792	1825	1889	1906	1941	2008	2014	2093	2147	2230	2318

VSD393218FP DL or DR	1966	1882	1916	1984	1999	2036	2107	2114	2194	2249	2334	2427
----------------------	------	------	------	------	------	------	------	------	------	------	------	------

VSD423218FP DL or DR	2064	1971	2006	2078	2092	2131	2206	2213	2295	2351	2437	2535
----------------------	------	------	------	------	------	------	------	------	------	------	------	------

VSD453218FP DL or DR	2116	2023	2058	2131	2147	2185	2262	2270	2355	2413	2501	2599
----------------------	------	------	------	------	------	------	------	------	------	------	------	------

VSD483218FP DL or DR	2165	2075	2109	2183	2201	2240	2316	2329	2416	2473	2564	2667
----------------------	------	------	------	------	------	------	------	------	------	------	------	------

VSD393221FP DL or DR	1966	1882	1916	1984	1999	2036	2107	2114	2194	2249	2334	2427
----------------------	------	------	------	------	------	------	------	------	------	------	------	------

VSD423221FP DL or DR	2064	1971	2006	2078	2092	2131	2206	2213	2295	2351	2437	2535
----------------------	------	------	------	------	------	------	------	------	------	------	------	------

VSD453221FP DL or DR	2116	2023	2058	2131	2147	2185	2262	2270	2355	2413	2501	2599
----------------------	------	------	------	------	------	------	------	------	------	------	------	------

VSD483221FP DL or DR	2165	2075	2109	2183	2201	2240	2316	2329	2416	2473	2564	2667
----------------------	------	------	------	------	------	------	------	------	------	------	------	------

VSD543218FP	2270	2175	2213	2293	2313	2353	2437	2446	2541	2605	2705	2812
-------------	------	------	------	------	------	------	------	------	------	------	------	------

VSD603218FP	2377	2274	2314	2402	2425	2467	2559	2566	2667	2735	2842	2956
-------------	------	------	------	------	------	------	------	------	------	------	------	------

VSD543221FP	2270	2175	2213	2293	2313	2353	2437	2446	2541	2605	2705	2812
-------------	------	------	------	------	------	------	------	------	------	------	------	------

VSD603221FP	2377	2274	2314	2402	2425	2467	2559	2566	2667	2735	2842	2956
-------------	------	------	------	------	------	------	------	------	------	------	------	------

**Custom Modifications**

AUTHL	CBO	CCO	CFNTD	CFP	CFRMO	CMAT	CND	DRWPWR	DRWTK	EXBKL	EXL	FB	FFDL	FPEB	FTK	FTKAV	ID	INFRM	LTI	MIP	RD	RECTKLL	RECTKLBK	RECTKL	RECTKR	RT	TKP	TOTSSS	VTK	WLI
•	•	•		STD	•	•*	•		•*	•	•	•	•	•	•	•	•		•*	•	•	•	•	•	•	•	•	•	•	•

\*Not available on 24", 27", 30", 33", and 60" wide, or on 18" deep \*Not available on 39", 42", 45", 48", 54" and 60" wide, or on 18" deep \*Not available on 24" wide

**Construction Upgrades**

APC	PE
•	•

**Door Options**

ALF	CG	DPSRR	MD	MFO
		•		

**VANITY SINK DRAWER BASE with FALSE PANEL, 34 1/2" HIGH, 18" or 21" DEEP**

24", 27", 30", or 33" (FP) = False Panel

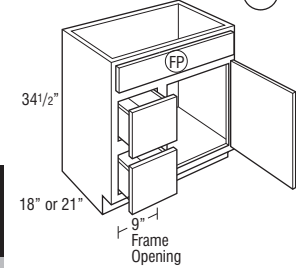

VSD243418FP DL or DR VSD243421FP DL or DR  
 VSD273418FP DL or DR VSD273421FP DL or DR  
 VSD303418FP DL or DR VSD303421FP DL or DR  
 VSD333418FP DL or DR VSD333421FP DL or DR

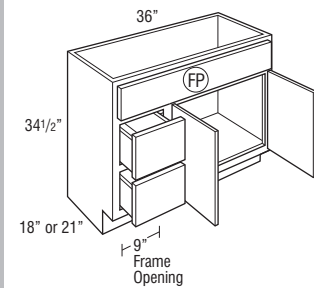

VSD363418FP DL or DR VSD363421FP DL or DR

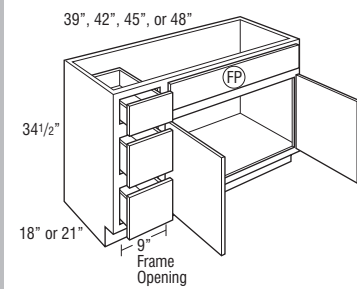

VSD393418FP DL or DR VSD393421FP DL or DR  
 VSD423418FP DL or DR VSD423421FP DL or DR  
 VSD453418FP DL or DR VSD453421FP DL or DR  
 VSD483418FP DL or DR VSD483421FP DL or DR

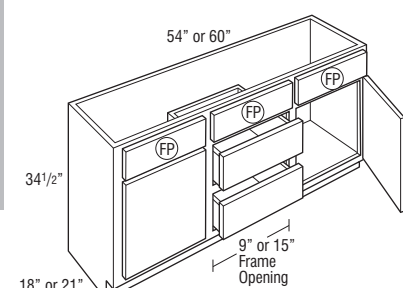

VSD543418FP VSD543421FP  
 VSD603418FP VSD603421FP

Model	1	2	3	4	5	6
VSD243418FP DL or DR	1362	1425	1465	1628	1594	1604
VSD273418FP DL or DR	1382	1449	1501	1684	1634	1646
VSD303418FP DL or DR	1401	1471	1535	1741	1675	1687
VSD333418FP DL or DR	1478	1551	1626	1851	1781	1802
VSD243421FP DL or DR	1362	1425	1465	1628	1594	1604
VSD273421FP DL or DR	1382	1449	1501	1684	1634	1646
VSD303421FP DL or DR	1401	1471	1535	1741	1675	1687
VSD333421FP DL or DR	1478	1551	1626	1851	1781	1802

VSD363418FP DL or DR	1553	1631	1717	1960	1886	1917
VSD363421FP DL or DR	1553	1631	1717	1960	1886	1917

<b>NEW</b> VSD393418FP DL or DR	1677	1754	1849	2035	1998	2013
---------------------------------	------	------	------	------	------	------

VSD423418FP DL or DR	1800	1877	1981	2109	2109	2109
----------------------	------	------	------	------	------	------

VSD453418FP DL or DR	1832	1911	2021	2207	2168	2168
----------------------	------	------	------	------	------	------

VSD483418FP DL or DR	1861	1947	2059	2304	2224	2224
----------------------	------	------	------	------	------	------

<b>NEW</b> VSD393421FP DL or DR	1677	1754	1849	2035	1998	2013
---------------------------------	------	------	------	------	------	------

VSD423421FP DL or DR	1800	1877	1981	2109	2109	2109
----------------------	------	------	------	------	------	------

VSD453421FP DL or DR	1832	1911	2021	2207	2168	2168
----------------------	------	------	------	------	------	------

VSD483421FP DL or DR	1861	1947	2059	2304	2224	2224
----------------------	------	------	------	------	------	------

VSD543418FP	1887	1981	2116	2404	2300	2336
-------------	------	------	------	------	------	------

VSD603418FP	1912	2015	2172	2506	2376	2446
-------------	------	------	------	------	------	------

VSD543421FP	1887	1981	2116	2404	2300	2336
-------------	------	------	------	------	------	------

VSD603421FP	1912	2015	2172	2506	2376	2446
-------------	------	------	------	------	------	------

- DL or DR indicates drawer location.
- CFP is available on 42", 45", and 48" widths, but standard on all other widths.

	Face Frame Opening Width		Available Sink Clearance Width	# of Sink Openings	# of Drawers
	Drawers	Doors			
VSD24...	9"	9"	21"	1	2
VSD27...	9"	12"	24"	1	2
VSD30...	9"	15"	27"	1	2
VSD33...	9"	18"	30"	1	2
VSD36...	9"	21"	33"	1	2
VSD39...	9"	24"	27"	1	3
VSD42...	9"	27"	30"	1	1
VSD45...	9"	30"	33"	1	1
VSD48...	9"	33"	36"	1	1
VSD54...	9"	18"	21"	2	2
VSD60...	15"	18"	21"	2	2

Model	7	8	9	10	11	12	13	14	15	16	17	18
VSD243418FP DL or DR	1793	1692	1721	1784	1796	1831	1896	1906	1977	2025	2100	2184
VSD273418FP DL or DR	1824	1736	1766	1831	1844	1877	1947	1955	2028	2078	2156	2243
VSD303418FP DL or DR	1853	1780	1808	1875	1892	1924	1997	2004	2079	2131	2211	2301
VSD333418FP DL or DR	1981	1900	1933	2005	2021	2058	2133	2142	2223	2279	2368	2464
VSD243421FP DL or DR	1793	1692	1721	1784	1796	1831	1896	1906	1977	2025	2100	2184
VSD273421FP DL or DR	1824	1736	1766	1831	1844	1877	1947	1955	2028	2078	2156	2243
VSD303421FP DL or DR	1853	1780	1808	1875	1892	1924	1997	2004	2079	2131	2211	2301
VSD333421FP DL or DR	1981	1900	1933	2005	2021	2058	2133	2142	2223	2279	2368	2464

VSD363418FP DL or DR	2108	2021	2057	2133	2151	2190	2271	2278	2367	2430	2524	2624
VSD363421FP DL or DR	2108	2021	2057	2133	2151	2190	2271	2278	2367	2430	2524	2624

VSD393418FP DL or DR	2214	2121	2158	2236	2255	2294	2378	2387	2478	2541	2638	2742
----------------------	------	------	------	------	------	------	------	------	------	------	------	------

VSD423418FP DL or DR	2319	2220	2259	2339	2359	2397	2485	2496	2589	2651	2751	2860
----------------------	------	------	------	------	------	------	------	------	------	------	------	------

VSD453418FP DL or DR	2380	2285	2324	2405	2425	2467	2556	2566	2663	2727	2829	2943
----------------------	------	------	------	------	------	------	------	------	------	------	------	------

VSD483418FP DL or DR	2439	2346	2386	2471	2489	2534	2624	2637	2734	2802	2910	3025
----------------------	------	------	------	------	------	------	------	------	------	------	------	------

VSD393421FP DL or DR	2214	2121	2158	2236	2255	2294	2378	2387	2478	2541	2638	2742
----------------------	------	------	------	------	------	------	------	------	------	------	------	------

VSD423421FP DL or DR	2319	2220	2259	2339	2359	2397	2485	2496	2589	2651	2751	2860
----------------------	------	------	------	------	------	------	------	------	------	------	------	------

VSD453421FP DL or DR	2380	2285	2324	2405	2425	2467	2556	2566	2663	2727	2829	2943
----------------------	------	------	------	------	------	------	------	------	------	------	------	------

VSD483421FP DL or DR	2439	2346	2386	2471	2489	2534	2624	2637	2734	2802	2910	3025
----------------------	------	------	------	------	------	------	------	------	------	------	------	------

VSD543418FP	2568	2467	2511	2603	2621	2668	2768	2781	2886	2961	3074	3198
-------------	------	------	------	------	------	------	------	------	------	------	------	------

VSD603418FP	2696	2586	2635	2732	2752	2802	2912	2925	3038	3119	3240	3371
-------------	------	------	------	------	------	------	------	------	------	------	------	------

VSD543421FP	2568	2467	2511	2603	2621	2668	2768	2781	2886	2961	3074	3198
-------------	------	------	------	------	------	------	------	------	------	------	------	------

VSD603421FP	2696	2586	2635	2732	2752	2802	2912	2925	3038	3119	3240	3371
-------------	------	------	------	------	------	------	------	------	------	------	------	------

**Custom Modifications**

AUTHL	CBO	CCO	CFNTO	CFP	CFRMO	CMAT	CND	DRWPWR	DRWTK	EXBKL	EXL	EXR	FB	FFDL	FPEB	FTK	FTKAV	ID	INVFRM	LTI	MIP	RD	RECTKALL	RECTKLBK	RECTKL	RECTKR	RT	TKP	TOTSSS	VTK	WLI
•	•	•		STD	•	•*	•		•*	•	•	•	•	•	•	•	•	•		•*	•	•	•	•	•	•	•	•	•	•	•

\*Not available on 24", 27", 30", 33", and 60" wide, or on 18" deep \*Not available on 39", 42", 45", 48", 54" and 60" wide, or on 18" deep \*Not available on 24" wide

**Construction Upgrades**

APC	PE
•	•

**Door Options**

ALF	CG	DPSRR	MD	MFO
		•		





**VANITY SINK DRAWER BASE with SIX DRAWERS & FALSE PANEL, 32" HIGH, 18" or 21" DEEP**

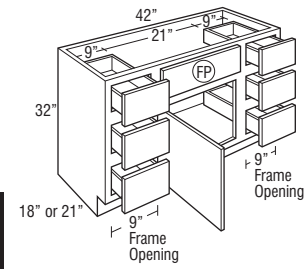

6VSD423218FP L or R  
6VSD423221FP L or R

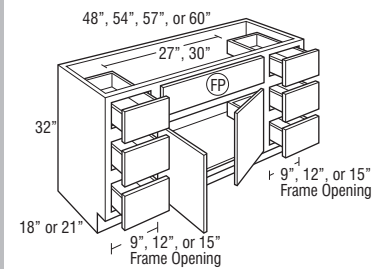

6VSD483218FP 6VSD543218FP 6VSD573218FP 6VSD603218FP  
6VSD483221FP 6VSD543221FP 6VSD573221FP 6VSD603221FP

Model	1	2	3	4	5	6
6VSD423218FP L or R	2502	2588	2585	2585	2585	2585
6VSD423221FP L or R	2502	2588	2585	2585	2585	2585
6VSD483218FP	2610	2706	2721	2721	2721	2721
6VSD483221FP	2610	2706	2721	2721	2721	2721
6VSD543218FP	2719	2822	2859	2859	2859	2859
6VSD543221FP	2719	2822	2859	2859	2859	2859
6VSD573218FP	2773	2881	2928	2928	2928	2928
6VSD573221FP	2773	2881	2928	2928	2928	2928
6VSD603218FP	2827	2939	2996	2996	2996	2996
6VSD603221FP	2827	2939	2996	2996	2996	2996

- 6VSD42 and 6VSD48 drawer stacks are 12" wide.
- 6VSD54 and 6VSD57 drawer stacks are 15" wide.
- 6VSD60 drawer stacks are 18" wide.
- 42" wide cabinets have a sink opening of only 21" instead of standard 27".

	Face Frame Opening Width		Available Sink Clearance Width	# of Sink Openings	# of Drawers
	Drawers	Doors			
6VSD42...	9"	15"	21"	1	6
6VSD48...	9"	21"	27"	1	6
6VSD54...	12"	21"	27"	1	6
6VSD57...	12"	24"	30"	1	6
6VSD60...	15"	21"	27"	1	6

**VANITY SINK DRAWER BASE with SIX DRAWERS & FALSE PANEL, 34 1/2" HIGH, 18" or 21" DEEP**

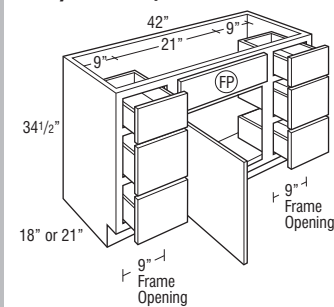

6VSD423418FP L or R  
6VSD423421FP L or R

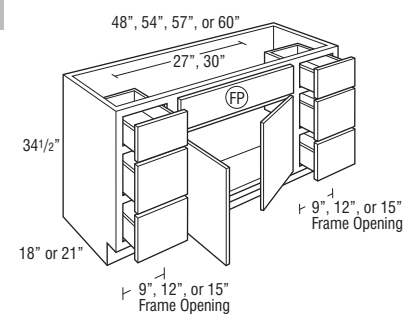

6VSD483418FP 6VSD543418FP 6VSD573418FP 6VSD603418FP  
6VSD483421FP 6VSD543421FP 6VSD573421FP 6VSD603421FP

6VSD423418FP L or R	2707	2809	2890	2890	2890	2890
6VSD423421FP L or R	2707	2809	2890	2890	2890	2890
6VSD483418FP	2832	2943	3048	3048	3048	3048
6VSD483421FP	2832	2943	3048	3048	3048	3048
6VSD543418FP	2957	3078	3205	3205	3205	3205
6VSD543421FP	2957	3078	3205	3205	3205	3205
6VSD573418FP	3020	3146	3283	3283	3283	3283
6VSD573421FP	3020	3146	3283	3283	3283	3283
6VSD603418FP	3082	3213	3361	3361	3361	3361
6VSD603421FP	3082	3213	3361	3361	3361	3361

- 6VSD42 and 6VSD48 drawer stacks are 12" wide.
- 6VSD54 and 6VSD57 drawer stacks are 15" wide.
- 6VSD60 drawer stacks are 18" wide.
- 42" wide cabinets have a sink opening of only 21" instead of standard 27".

	Face Frame Opening Width		Available Sink Clearance Width	# of Sink Openings	# of Drawers
	Drawers	Doors			
6VSD42...	9"	15"	21"	1	6
6VSD48...	9"	21"	27"	1	6
6VSD54...	12"	21"	27"	1	6
6VSD57...	12"	24"	30"	1	6
6VSD60...	15"	21"	27"	1	6

Model	7	8	9	10	11	12	13	14	15	16	17	18
6VSD423218FP L or R	2842	2705	2749	2838	2857	2903	3003	3012	3114	3187	3299	3432
6VSD423221FP L or R	2842	2705	2749	2838	2857	2903	3003	3012	3114	3187	3299	3432
6VSD483218FP	2994	2850	2898	2994	3014	3064	3167	3178	3290	3364	3484	3625
6VSD483221FP	2994	2850	2898	2994	3014	3064	3167	3178	3290	3364	3484	3625
6VSD543218FP	3144	2997	3048	3149	3171	3224	3332	3346	3464	3544	3670	3815
6VSD543221FP	3144	2997	3048	3149	3171	3224	3332	3346	3464	3544	3670	3815
6VSD573218FP	3220	3070	3123	3227	3250	3305	3414	3429	3552	3633	3763	3912
6VSD573221FP	3220	3070	3123	3227	3250	3305	3414	3429	3552	3633	3763	3912
6VSD603218FP	3295	3143	3197	3304	3328	3385	3496	3512	3639	3722	3855	4008
6VSD603221FP	3295	3143	3197	3304	3328	3385	3496	3512	3639	3722	3855	4008

Custom Modifications

AUTHL	AUTHR	CBO	CCO	CFNTO	CFP	CFRMO	CMAT	CND	DRWPWR	DRWTK	EXBKL	EXBKR	EXL	EXR	FB	FFDL	FPEB	FTK	FTKAV	FTKVF	ID	INFRM	LTI	MIP	RD	RECTKALL	RECTKLBK	RECTKLR	RECTKR	RT	TKP	TOTSSS	VTK	WLI	
•	•	•	•	•	•	•	•	•	•	•	•	•	•	•	•	•	•	•	•	•	•	•	•	•	•	•	•	•	•	•	•	•	•	•	•

\*Not available on 42" wide, or on 18" deep \*Available only on 60" wide

Construction Upgrades

APC	PE
•	•

Door Options

ALF	CG	DPSRR	MD	MFO
•	•	•	•	•

6VSD423418FP L or R	3179	3029	3078	3176	3207	3261	3371	3383	3500	3582	3712	3861
6VSD423421FP L or R	3179	3029	3078	3176	3207	3261	3371	3383	3500	3582	3712	3861
6VSD483418FP	3352	3197	3250	3356	3386	3443	3559	3574	3699	3786	3925	4082
6VSD483421FP	3352	3197	3250	3356	3386	3443	3559	3574	3699	3786	3925	4082
6VSD543418FP	3526	3365	3422	3536	3564	3626	3750	3764	3900	3991	4137	4301
6VSD543421FP	3526	3365	3422	3536	3564	3626	3750	3764	3900	3991	4137	4301
6VSD573418FP	3612	3449	3508	3626	3654	3716	3844	3860	4000	4094	4243	4411
6VSD573421FP	3612	3449	3508	3626	3654	3716	3844	3860	4000	4094	4243	4411
6VSD603418FP	3698	3532	3594	3716	3743	3806	3938	3956	4100	4196	4348	4521
6VSD603421FP	3698	3532	3594	3716	3743	3806	3938	3956	4100	4196	4348	4521

Custom Modifications

AUTHL	AUTHR	CBO	CCO	CFNTO	CFP	CFRMO	CMAT	CND	DRWPWR	DRWTK	EXBKL	EXBKR	EXL	EXR	FB	FFDL	FPEB	FTK	FTKAV	FTKVF	ID	INFRM	LTI	MIP	RD	RECTKALL	RECTKLBK	RECTKLR	RECTKR	RT	TKP	TOTSSS	VTK	WLI
•	•	•	•	•	•	•	•	•	•	•	•	•	•	•	•	•	•	•	•	•	•	•	•	•	•	•	•	•	•	•	•	•	•	•

\*Not available on 42" wide, or on 18" deep \*Available only on 60" wide

Construction Upgrades

APC	PE
•	•

Door Options

ALF	CG	DPSRR	MD	MFO
•	•	•	•	•



**VANITY SINK DRAWER BASE with EIGHT DRAWERS, 34 1/2" HIGH, 18" or 21" DEEP**

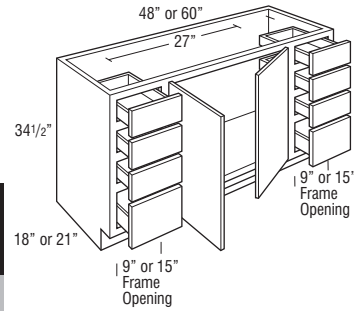

Model	1	2	3	4	5	6
8VSD483418	3110	3205	3219	3219	3219	3219
8VSD603418	3325	3439	3491	3491	3491	3491
8VSD483421	3110	3205	3219	3219	3219	3219
8VSD603421	3325	3439	3491	3491	3491	3491

- 8VSD48 drawer stacks are 12" wide.
- 8VSD60 drawer stacks are 18" wide.
- All have 27" wide space between drawers for sink.

	Face Frame Opening Width		Available Sink Clearance Width	# of Sink Openings	# of Drawers
	Drawers	Doors			
8VSD48...	9"	21"	27"	1	8
8VSD60...	15"	21"	27"	1	8

**VANITY SINK DRAWER BASE with EIGHT DRAWERS & FALSE PANEL, 34 1/2" HIGH, 18 or 21" DEEP**

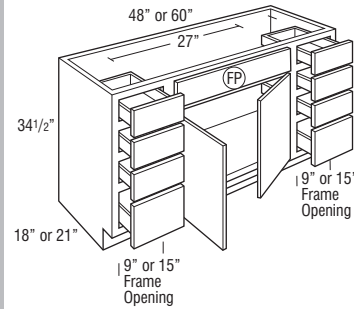

8VSD483418FP	3332	3442	3547	3547	3547	3547
8VSD603418FP	3582	3712	3860	3860	3860	3860
8VSD483421FP	3332	3442	3547	3547	3547	3547
8VSD603421FP	3582	3712	3860	3860	3860	3860

- 8VSD48 drawer stacks are 12" wide.
- 8VSD60 drawer stacks are 18" wide.
- All have 27" wide space between drawers for sink.

	Face Frame Opening Width		Available Sink Clearance Width	# of Sink Openings	# of Drawers
	Drawers	Doors			
8VSD48...	9"	21"	27"	1	8
8VSD60...	15"	21"	27"	1	8

**VANITY ANGLE CORNER SINK FRONT, 32" HIGH**

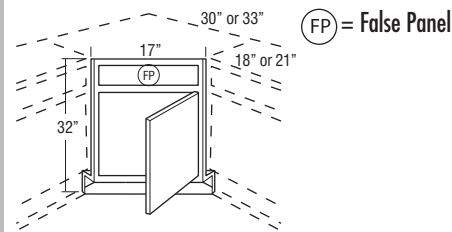

VACSF L or R	420	448	499	557	616	643
--------------	-----	-----	-----	-----	-----	-----

- Edges are angled at 45°.
- Requires sink bottom for field installation. Order separately.
- Toekick and toekick retainer shipped unattached from the face frame.
- Full overlay styles use the same width doors as partial overlay styles (14 1/2" wide) with a partial overlay hinge (38NPOHINGE) to allow for proper door clearance with adjacent cabinets.

Adjacent Cabinet Depth	Wall Width	Frame	Maximum Sink Width	Maximum Sink Depth
21"	33" x 33"	17"	25 3/4"	22 7/8"
18"	30" x 30"	17"	25 3/4"	18 5/8"

**VANITY ANGLE CORNER SINK FRONT BOTTOM**

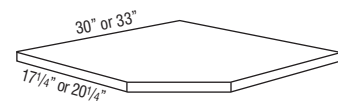

VACSF3018	115	115	115	115	115	115
VACSF3321	121	121	121	121	121	121

- Designed for use with Vanity Angle Corner Sink Front.
- 3/8" thick.
- Trimmable.

Model	7	8	9	10	11	12	13	14	15	16	17	18
8VSD483418	3491	3347	3394	3488	3511	3560	3664	3676	3785	3859	3980	4118
8VSD603418	3790	3638	3690	3799	3822	3878	3990	4008	4134	4216	4349	4503
8VSD483421	3491	3347	3394	3488	3511	3560	3664	3676	3785	3859	3980	4118
8VSD603421	3790	3638	3690	3799	3822	3878	3990	4008	4134	4216	4349	4503

**Custom Modifications**

AUTHL	AUTHR	CBO	CCO	CFNTO	CFP	CFRMO	CMAT	CND	DRWPWR	DRWTK	EXBKL	EXBKR	EXL	EXR	FB	FFDL	FFDR	FPEB	FTK	FTKAV	FTKRV	ID	INVFRM	LTI	MIP	RD	RECTKALL	RECTKLBK	RECTKLR	RT	TKP	TOTSSS	VTK	WLI	
•	•	•	•	•	•	•	•*	•	•*	•	•	•	•	•	•	•	•	•	•	•	•	•	•	•	•	•	•	•	•	•	•	•	•	•	•

\*Not available on 18" deep \*Available only on 60" wide

**Construction Upgrades**

APC	PE
•	•

**Door Options**

ALF	CG	DPSRR	MD	MFO
•	•	•	•	•

8VSD483418FP	3851	3696	3749	3856	3886	3942	4059	4072	4197	4285	4423	4580
8VSD603418FP	4196	4032	4092	4216	4242	4306	4438	4454	4599	4696	4848	5021
8VSD483421FP	3851	3696	3749	3856	3886	3942	4059	4072	4197	4285	4423	4580
8VSD603421FP	4196	4032	4092	4216	4242	4306	4438	4454	4599	4696	4848	5021

**Custom Modifications**

AUTHL	AUTHR	CBO	CCO	CFNTO	CFP	CFRMO	CMAT	CND	DRWPWR	DRWTK	EXBKL	EXBKR	EXL	EXR	FB	FFDL	FFDR	FPEB	FTK	FTKAV	FTKRV	ID	INVFRM	LTI	MIP	RD	RECTKALL	RECTKLBK	RECTKLR	RT	TKP	TOTSSS	VTK	WLI
•	•	•	•	•	•	•	•*	•	•*	•	•	•	•	•	•	•	•	•	•	•	•	•	•	•	•	•	•	•	•	•	•	•	•	•

\*Not available on 18" deep \*Available only on 60" wide

**Construction Upgrades**

APC	PE
•	•

**Door Options**

ALF	CG	DPSRR	MD	MFO
•	•	•	•	•

VACSF L or R	614	682	696	721	730	744	771	778	810	831	866	898
--------------	-----	-----	-----	-----	-----	-----	-----	-----	-----	-----	-----	-----

**Custom Modifications**

AUTHL	AUTHR	CBO	CCO	CFNTO	CFP	CFRMO	CMAT	CND	DRWPWR	DRWTK	EXBKL	EXBKR	EXL	EXR	FB	FFDL	FFDR	FPEB	FTK	FTKAV	FTKRV	ID	INVFRM	LTI	MIP	RD	RECTKALL	RECTKLBK	RECTKLR	RT	TKP	TOTSSS	VTK	WLI
					STD	•		•																•										

**Construction Upgrades**

APC	PE

**Door Options**

ALF	CG	DPSRR	MD	MFO
		•		

VACSF3018	115	115	115	115	115	115	115	115	115	115	115	115
VACSF3321	121	121	121	121	121	121	121	121	121	121	121	121

**Custom Modifications**

AUTHL	AUTHR	CBO	CCO	CFNTO	CFP	CFRMO	CMAT	CND	DRWPWR	DRWTK	EXBKL	EXBKR	EXL	EXR	FB	FFDL	FFDR	FPEB	FTK	FTKAV	FTKRV	ID	INVFRM	LTI	MIP	RD	RECTKALL	RECTKLBK	RECTKLR	RT	TKP	TOTSSS	VTK	WLI	
																																			•

**Construction Upgrades**

APC	PE
•	

**Door Options**

ALF	CG	DPSRR	MD	MFO

**UNDER COUNTER DRAWER, 4 3/4" HIGH, 18" or 21" DEEP**

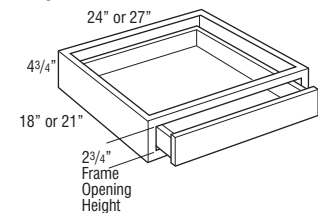

UCD2418 UCD2421  
UCD2718 UCD2721

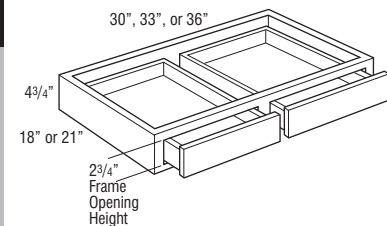

UCD3018 UCD3021  
UCD3318 UCD3321  
UCD3618 UCD3621

Model	1	2	3	4	5	6
UCD2418	448	448	448	448	448	448
UCD2718	506	506	506	506	506	506
UCD2421	448	448	448	448	448	448
UCD2721	506	506	506	506	506	506

UCD3018	589	589	589	589	589	589
<b>NEW</b> UCD3318	632	632	632	632	632	632
UCD3618	675	675	675	675	675	675
UCD3021	589	589	589	589	589	589
<b>NEW</b> UCD3321	632	632	632	632	632	632
UCD3621	675	675	675	675	675	675

- Cabinet is 4 3/4" high. Drawer box within cabinet is 2" high.
- Not trimmable.
- Drawer front is 3/4" slab front.
- The frame to end panel offset is 3/4", which is designed to accommodate the vanity desk leg.
- End panels ordered in Trademark will feature non-matching laminate exterior. When ordered in PE or APC, end panels will not be finished.
- Reduced depth is available in 3" increments.

**SPECIAL SIZE VANITY, 32" HIGH, 16" DEEP**

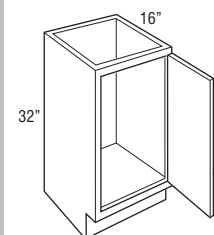

MV183216 L or R	417	446	464	530	578	610
-----------------	-----	-----	-----	-----	-----	-----

- MV = mini-vanity.

**SPECIAL SIZE VANITY, 34 1/2" HIGH, 16" DEEP**

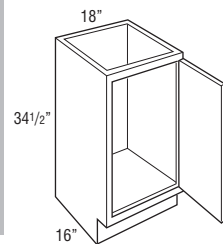

MV183416 L or R	459	490	511	583	635	669
-----------------	-----	-----	-----	-----	-----	-----

- MV = mini vanity.

**VANITY HAMPER, 32" HIGH, 21" DEEP**

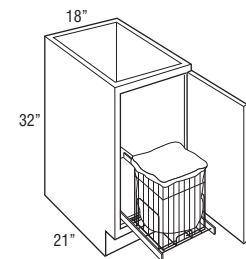

VH183221FH L or R	715	752	791	855	852	855
-------------------	-----	-----	-----	-----	-----	-----

- Includes full extension removable chrome pull-out hamper with removable cloth liner.
- Hamper size is 19 3/8" high x 14 3/4" wide x 18" deep.

Model	7	8	9	10	11	12	13	14	15	16	17	18
UCD2418	493	472	479	498	504	514	532	533	555	571	593	618
UCD2718	557	534	546	566	571	558	662	614	637	685	710	738
UCD2421	493	472	479	498	504	514	532	533	555	571	593	618
UCD2721	557	534	546	566	571	558	662	614	637	685	710	738

UCD3018	650	620	632	658	662	675	700	702	729	748	778	810
UCD3318	695	665	680	706	710	722	788	757	786	826	857	892
UCD3618	740	710	727	753	758	769	875	811	842	904	936	974
UCD3021	650	620	632	658	662	675	700	702	729	748	778	810
UCD3321	695	665	680	706	710	722	788	757	786	826	857	892
UCD3621	740	710	727	753	758	769	875	811	842	904	936	974

**Custom Modifications**

AUTHL	AUTHR	CBO	CCO	CFNTO	CFP	CFRMO	CMAT	CND	DRWPWR	DRWTK	EXBKL	EXBKR	EXL	EXR	FB	FFDL	FPEB	FTK	FTKAV	FTKRV	ID	INVFRM	LTI	MIP	RD	RECTKALL	RECTKLBK	RECTKLR	RECTKR	RT	TKP	TOTSSS	VTK	WLI
		•	•			•					•	•	•				•	•	•			•		•	•		•	•					•	•

**Construction Upgrades**

APC	PE
•	•

**Door Options**

ALF	CG	DPSRR	MD	MFO

MV183216 L or R	583	644	657	684	688	703	731	734	764	786	819	853
-----------------	-----	-----	-----	-----	-----	-----	-----	-----	-----	-----	-----	-----

**Custom Modifications**

AUTHL	AUTHR	CBO	CCO	CFNTO	CFP	CFRMO	CMAT	CND	DRWPWR	DRWTK	EXBKL	EXBKR	EXL	EXR	FB	FFDL	FPEB	FTK	FTKAV	FTKRV	ID	INVFRM	LTI	MIP	RD	RECTKALL	RECTKLBK	RECTKLR	RECTKR	RT	TKP	TOTSSS	VTK	WLI
		•	•	•		•					•	•	•				•	•	•			•		•	•		•	•					•	•

**Construction Upgrades**

APC	PE
•	•

**Door Options**

ALF	CG	DPSRR	MD	MFO
		•		

MV183416 L or R	640	710	720	753	758	772	806	808	841	865	903	936
-----------------	-----	-----	-----	-----	-----	-----	-----	-----	-----	-----	-----	-----

**Custom Modifications**

AUTHL	AUTHR	CBO	CCO	CFNTO	CFP	CFRMO	CMAT	CND	DRWPWR	DRWTK	EXBKL	EXBKR	EXL	EXR	FB	FFDL	FPEB	FTK	FTKAV	FTKRV	ID	INVFRM	LTI	MIP	RD	RECTKALL	RECTKLBK	RECTKLR	RECTKR	RT	TKP	TOTSSS	VTK	WLI
		•	•	•		•					•	•	•				•	•	•			•		•	•		•	•					•	•

**Construction Upgrades**

APC	PE
•	•

**Door Options**

ALF	CG	DPSRR	MD	MFO
		•		

VH183221FH L or R	938	904	918	954	960	975	1013	1016	1053	1083	1124	1169
-------------------	-----	-----	-----	-----	-----	-----	------	------	------	------	------	------

**Custom Modifications**

AUTHL	AUTHR	CBO	CCO	CFNTO	CFP	CFRMO	CMAT	CND	DRWPWR	DRWTK	EXBKL	EXBKR	EXL	EXR	FB	FFDL	FPEB	FTK	FTKAV	FTKRV	ID	INVFRM	LTI	MIP	RD	RECTKALL	RECTKLBK	RECTKLR	RECTKR	RT	TKP	TOTSSS	VTK	WLI
•	•	•	•	•	•	•				•	•	•	•				•	•	•			•		•	•		•	•					•	•

**Construction Upgrades**

APC	PE
•	•

**Door Options**

ALF	CG	DPSRR	MD	MFO
		•		





**VANITY WALL HUNG DOUBLE DOOR with U-SHAPED PULL-OUTS, 23 1/2" HIGH, 21" DEEP**

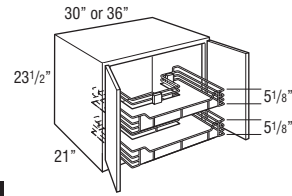

Model	1	2	3	4	5	6
<b>VWH3023.521U</b>	1813	1857	1955	2055	2116	2163
<b>VWH3623.521U</b>	1906	1950	2048	2148	2208	2256

- Includes two chrome U-shaped Smart Stop roll-outs with non-slip gray shelf liner.
- Cut-out for U-shape on bottom roll-out is 6 1/8" from back of cabinet.
- Cut-out for U-shape on top roll-out is 12 1/8" from back of cabinet.
- Features a full cabinet top that can be routed for sink installation.
- Standard with All-plywood Construction (APC) and Furniture Finished Plywood Ends (FPEB).
- Installation to be performed by qualified professionals only.
- Unit must be securely fastened with sufficient type, quantity and size of screws to all available wall studs and internal structural wall blocking placed between wall studs. Additional bracing may be required.
- Installation instructions and required 3 1/2" installation screws included, standard 2 1/2" installation screws are not sufficient in this application.
- The use of internal structural wall blocking (2 x 6's) is required to provide secure horizontal attachment points between wall studs.
- Do not exceed loading of 25 lbs./sq. ft. for countertop and sink.
- Do not exceed loading of 15 lbs./sq. ft. for contents on shelves and/or drawers.
- Avoid use of concrete or other heavy masonry countertops.

**VANITY WALL HUNG SINGLE DOOR, 23 1/2" HIGH, 21" DEEP**

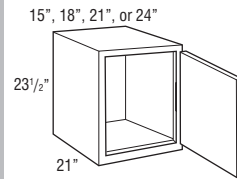

<b>VWH1523.521 L or R</b>	732	761	851	909	919	957
<b>VWH1823.521 L or R</b>	751	780	873	932	943	982
<b>VWH2123.521 L or R</b>	770	800	895	956	967	1007
<b>VWH2423.521 L or R</b>	790	820	918	980	992	1033

- Features a full cabinet top that can be routed for sink installation.
- Standard with All-plywood Construction (APC) and Furniture Finished Plywood Ends (FPEB).
- Installation to be performed by qualified professionals only.
- Unit must be securely fastened with sufficient type, quantity and size of screws to all available wall studs and internal structural wall blocking placed between wall studs. Additional bracing may be required.
- Installation instructions and required 3 1/2" installation screws included, standard 2 1/2" installation screws are not sufficient in this application.
- The use of internal structural wall blocking (2 x 6's) is required to provide secure horizontal attachment points between wall studs.
- Do not exceed loading of 25 lbs./sq. ft. for countertop and sink.
- Do not exceed loading of 15 lbs./sq. ft. for contents on shelves and/or drawers.
- Avoid use of concrete or other heavy masonry countertops.

**VANITY WALL HUNG DOUBLE DOOR, 23 1/2" HIGH, 21" DEEP**

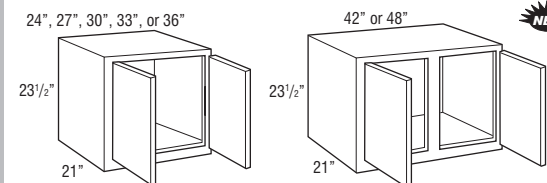

VWH2423.521  
VWH2723.521  
VWH3023.521  
VWH3323.521  
VWH3623.521

VWH4223.521  
VWH4823.521CS

<b>VWH2423.521</b>	810	841	942	1005	1017	1059
<b>VWH2723.521</b>	831	863	966	1031	1043	1086
<b>VWH3023.521</b>	852	885	991	1057	1070	1114
<b>VWH3323.521</b>	874	909	1022	1100	1122	1168
<b>VWH3623.521</b>	895	932	1052	1142	1173	1222
<b>VWH4223.521</b>	949	986	1118	1216	1257	1306
<b>VWH4823.521CS</b>	1038	1084	1234	1344	1407	1435

- Features a full cabinet top that can be routed for sink installation.
- Standard with All-plywood Construction (APC) and Furniture Finished Plywood Ends (FPEB).
- Installation to be performed by qualified professionals only.
- Unit must be securely fastened with sufficient type, quantity and size of screws to all available wall studs and internal structural wall blocking placed between wall studs. Additional bracing may be required.
- Installation instructions and required 3 1/2" installation screws included, standard 2 1/2" installation screws are not sufficient in this application.
- The use of internal structural wall blocking (2 x 6's) is required to provide secure horizontal attachment points between wall studs.
- Do not exceed loading of 25 lbs./sq. ft. for countertop and sink.
- Do not exceed loading of 15 lbs./sq. ft. for contents on shelves and/or drawers.
- Avoid use of concrete or other heavy masonry countertops.

Model	7	8	9	10	11	12	13	14	15	16	17	18
<b>VWH3023.521U</b>	2143	2223	2246	2291	2299	2325	2373	2377	2428	2464	2518	2571
<b>VWH3623.521U</b>	2236	2316	2339	2384	2392	2418	2466	2470	2521	2557	2611	2664

**Custom Modifications**

AUTHL	AUTHR	CBO	CCO	CFNTO	CFP	CFRMO	CMAT	CND	DRWPWR	DRWTK	EXBKL	EXBKR	EXL	EXR	FB	FFDL	FFDR	FPEB	FTK	FTKAV	FTKFV	ID	INVFRM	LTI	MIP	RD	RECTKALL	RECTKLBK	RECTKL	RECTKR	RT	TKP	TOTSSS	VTK	WLI
•	•	•	•	•	•	•	•	•	•	•	•	•	•	•	•	•	•	•	•	•	•	•	•	•	•	•	•	•	•	•	•	•	•	•	•

**Construction Upgrades**

APC	PE
•	•

**Door Options**

ALF	CG	DPSRR	MD	MFO
•	•	•	•	•

<b>VWH1523.521 L or R</b>	970	999	1014	1045	1051	1064	1096	1102	1138	1158	1193	1229
<b>VWH1823.521 L or R</b>	995	1025	1040	1072	1078	1091	1124	1130	1167	1188	1224	1260
<b>VWH2123.521 L or R</b>	1021	1051	1067	1099	1106	1119	1153	1159	1197	1218	1255	1292
<b>VWH2423.521 L or R</b>	1047	1078	1094	1127	1134	1148	1183	1189	1228	1249	1287	1325

**Custom Modifications**

AUTHL	AUTHR	CBO	CCO	CFNTO	CFP	CFRMO	CMAT	CND	DRWPWR	DRWTK	EXBKL	EXBKR	EXL	EXR	FB	FFDL	FFDR	FPEB	FTK	FTKAV	FTKFV	ID	INVFRM	LTI	MIP	RD	RECTKALL	RECTKLBK	RECTKL	RECTKR	RT	TKP	TOTSSS	VTK	WLI
•	•	•	•	•	•	•	•	•	•	•	•	•	•	•	•	•	•	•	•	•	•	•	•	•	•	•	•	•	•	•	•	•	•	•	•

\*Available only on 24" wide

**Construction Upgrades**

APC	PE
•	•

**Door Options**

ALF	CG	DPSRR	MD	MFO
•	•	•	•	•

<b>VWH2423.521</b>	1074	1106	1122	1156	1163	1177	1213	1219	1259	1281	1320	1359
<b>VWH2723.521</b>	1102	1134	1151	1186	1193	1207	1244	1250	1291	1314	1354	1394
<b>VWH3023.521</b>	1130	1163	1180	1216	1224	1238	1276	1282	1324	1348	1389	1430
<b>VWH3323.521</b>	1178	1219	1236	1273	1282	1300	1339	1345	1389	1415	1461	1505
<b>VWH3623.521</b>	1225	1274	1291	1330	1339	1361	1401	1408	1454	1481	1532	1579

<b>VWH4223.521</b>	1304	1367	1388	1430	1441	1462	1510	1514	1563	1597	1650	1703
<b>VWH4823.521CS</b>	1447	1502	1525	1575	1654	1646	1741	1711	1768	1862	1926	1991

**Custom Modifications**

AUTHL	AUTHR	CBO	CCO	CFNTO	CFP	CFRMO	CMAT	CND	DRWPWR	DRWTK	EXBKL	EXBKR	EXL	EXR	FB	FFDL	FFDR	FPEB	FTK	FTKAV	FTKFV	ID	INVFRM	LTI	MIP	RD	RECTKALL	RECTKLBK	RECTKL	RECTKR	RT	TKP	TOTSSS	VTK	WLI
•	•	•	•	•	•	•	•	•	•	•	•	•	•	•	•	•	•	•	•	•	•	•	•	•	•	•	•	•	•	•	•	•	•	•	

**Construction Upgrades**

APC	PE
•	•

**Door Options**

ALF	CG	DPSRR	MD	MFO
•	•	•	•	•

**VANITY WALL TOWEL BAR**

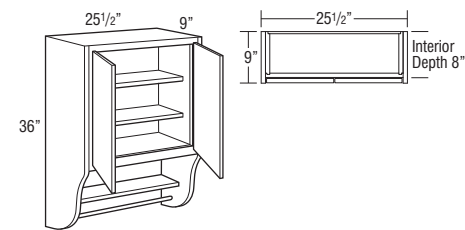

Model	1	2	3	4	5	6
<b>VWTB24</b>	709	756	758	857	954	1000

- Includes 2 adjustable interior shelves, 1 fixed shelf, and towel rack underneath.
- Cabinet has butt doors, no center stile.
- Cabinet features factory applied 3/4" matching veneer over furniture board core end panels. Total cabinet width is 25 1/2".
- Interior cabinet case has plywood end panels.
- When ordered in APC, back, top, bottom and adjustable shelves are plywood.

Model	7	8	9	10	11	12	13	14	15	16	17	18
<b>VWTB24</b>	940	1060	1083	1126	1135	1158	1203	1212	1260	1294	1347	1400

**Custom Modifications**

AUTHL	AUTHR	CBO	CCO	CFNTO	CFP	CFRMO	CMAT	CND	DRWPWR	DRWTK	EXBKL	EXBKR	EXL	EXR	FB	FFDL	FFDR	FPEB	FTK	FTKAV	FTKFV	ID	INVFRM	LTI	MIP	RD	RECTKALL	RECTKLBK	RECTKL	RECTKR	RT	TKP	TOTSSS	VTK	WLI
		•	•	•		•					•	•				STD									•										•

**Construction Upgrades**

APC	PE
•	STD

**Door Options**

ALF	CG	DPSRR	MD	MFO
•	•	•		•

<b>W12306 L or R</b>	471	516	526	547	554	563	583	588	613	629	655	681
<b>W15306 L or R</b>	519	556	566	588	594	609	631	632	659	678	706	734
<b>W18306 L or R</b>	551	601	614	639	643	655	682	686	714	733	763	792
<b>W24306 L or R</b>	718	757	772	803	809	826	857	863	894	922	960	998

<b>W24306</b>	789	821	836	871	878	896	932	935	975	1001	1043	1085
---------------	-----	-----	-----	-----	-----	-----	-----	-----	-----	------	------	------

**Custom Modifications**

AUTHL	AUTHR	CBO	CCO	CFNTO	CFP	CFRMO	CMAT	CND	DRWPWR	DRWTK	EXBKL	EXBKR	EXL	EXR	FB	FFDL	FFDR	FPEB	FTK	FTKAV	FTKFV	ID	INVFRM	LTI	MIP	RD	RECTKALL	RECTKLBK	RECTKL	RECTKR	RT	TKP	TOTSSS	VTK	WLI
		•	•	•		•					•	•	•					•							•										•

**Construction Upgrades**

APC	PE
•	•

**Door Options**

ALF	CG	DPSRR	MD	MFO
•	•	•	•	•

<sup>†</sup>Not available on 24" wide

<b>VWM1830 L or R</b>	655	686	696	723	728	739	768	770	798	820	848	880
<b>VWM2430 L or R</b>	785	823	839	869	875	891	923	929	962	989	1026	1064

<b>VWM3030</b>	959	1010	1028	1066	1075	1095	1135	1137	1182	1215	1262	1309
<b>VWM3630</b>	1043	1092	1114	1156	1164	1184	1229	1238	1286	1316	1367	1418
<b>VWM4230</b>	1121	1180	1208	1251	1261	1286	1333	1340	1392	1425	1481	1540

**Custom Modifications**

AUTHL	AUTHR	CBO	CCO	CFNTO	CFP	CFRMO	CMAT	CND	DRWPWR	DRWTK	EXBKL	EXBKR	EXL	EXR	FB	FFDL	FFDR	FPEB	FTK	FTKAV	FTKFV	ID	INVFRM	LTI	MIP	RD	RECTKALL	RECTKLBK	RECTKL	RECTKR	RT	TKP	TOTSSS	VTK	WLI
		•	•	•		•					•	•	•					•							•										•

**Construction Upgrades**

APC	PE
•	•

**Door Options**

ALF	CG	DPSRR	MD	MFO
	STD			

**VANITY WALL, 30" HIGH, 6" DEEP**

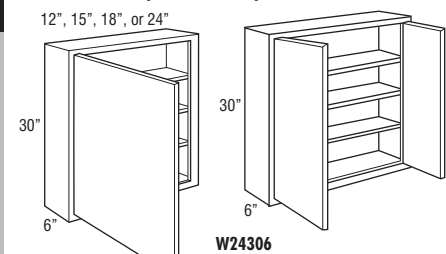

- W12306 L or R
- W15306 L or R
- W18306 L or R
- W24306 L or R

<b>W12306 L or R</b>	328	348	380	428	463	487
<b>W15306 L or R</b>	340	362	400	472	499	522
<b>W18306 L or R</b>	362	387	428	501	537	568
<b>W24306 L or R</b>	459	490	569	655	707	714

<b>W24306</b>	531	563	620	718	841	776
---------------	-----	-----	-----	-----	-----	-----

**VANITY WALL MIRROR CABINET, 30" HIGH, 4 9/16" DEEP**

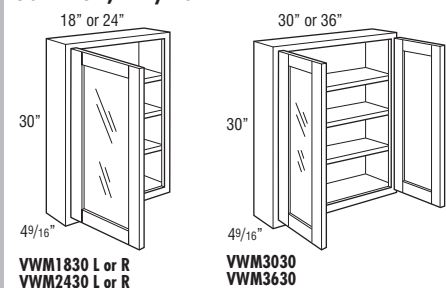

- VWM1830 L or R
- VWM2430 L or R

- VWM3030
- VWM3630

<b>VWM1830 L or R</b>	445	469	530	602	622	650
<b>VWM2430 L or R</b>	527	556	635	721	772	781

<b>VWM3030</b>	639	679	770	880	912	957
<b>VWM3630</b>	680	719	828	956	989	1036
<b>VWM4230</b>	712	753	892	1026	1069	1120

- Standard with CG doors and installed mirror glass.
- Unit intended to be surface mounted. Features standard 1/4" face frame reveal on ends.
- Not available in Aspen, Derazi, Gallo, Herra, Prestley, and Rivali styles.
- Adjustable shelves.

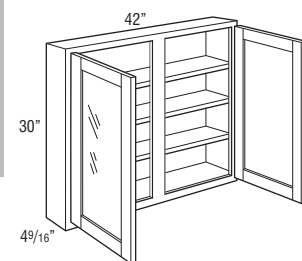

VWM4230

**VANITY MIRROR with SIDE PULL-OUTS, 32 1/2" HIGH, 4 7/8" DEEP**

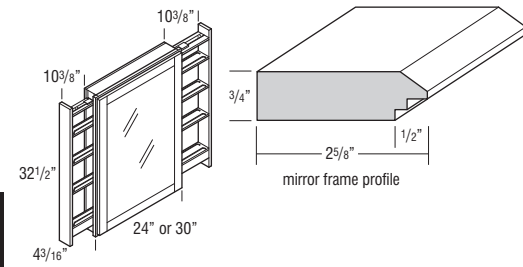

Model	1	2	3	4	5	6
<b>VMP2432.5</b>	N/A	1033	1033	1033	1033	1033
<b>VMP3032.5</b>	N/A	1222	1222	1222	1222	1222

- One full extension natural wood finish pull-out on each side with three adjustable shelves and chrome rail sides (Smart Stop not included).
- Pull-outs extend 10 3/8" on each side. VMP2432.5 open width is 44 3/4". VMP3032.5 open width is 50 3/4".
- Mirror frame has a shaker outside profile and a bevel inside profile with a 1/4" face frame reveal. Mirror is not removable.
- Mirror visible dimensions:  
VMP2432.5 - 26 3/4" high x 18 1/4" wide  
VMP3032.5 - 26 3/4" high x 24 1/4" wide
- Installation instructions included.
- When Distressing is selected, only fillers will receive treatment.
- When Heirlooming is selected, only mirror frame will receive treatment.
- Pull-outs feature plain fillers. If a more decorative look is desired, overlay fillers or embellishments may be ordered separately and field installed.

**VANITY MIRROR**

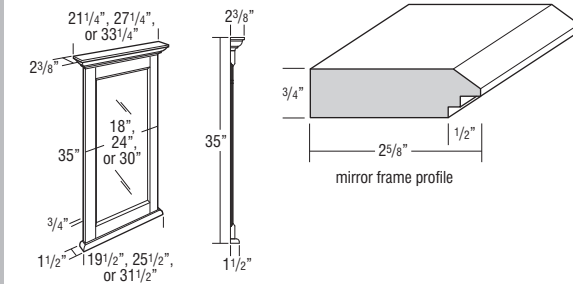

Model	1	2	3	4	5	6
<b>VM2135</b>	N/A	807	807	807	807	807
<b>VM2735</b>	N/A	875	875	875	875	875
<b>VM3335</b>	N/A	954	954	954	954	954

- Moulding included on vanity mirror is not a standard moulding. SWLCRMB is similar.
- Mirror glass is beveled.
- Includes two installed metal hanging hooks on back.

Model	Overall Dimensions Width	Overall Dimensions Height	Mirror - Visible Dimensions Width	Mirror - Visible Dimensions Height
VM2135	21 1/4"	35"	12 15/16"	26 15/16"
VM2735	27 1/4"	35"	18 15/16"	26 15/16"
VM3335	33 1/4"	35"	24 15/16"	26 15/16"

**SINGLE DOOR MEDICINE CABINET**

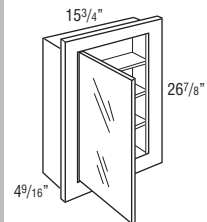

Model	1	2	3	4	5	6
<b>MC16</b>	934	934	934	934	934	934

- Unit can be surface mounted or recessed.
- Door of cabinet is glass mirror, 12 5/8" wide x 23 1/2" high.
- Matching cabinet doors not available.
- Cabinet has wood frame.
- Finished exterior.
- Standard interior.
- Face frame has a profiled inside and outside edge.
- If ordered with Heirlooming Technique, will not feature sand-through characteristics.

Model	Cabinet Dimensions			Cut-out Dimensions		
	Width	Height	Depth	Width	Height	Depth
MC16	15 3/4"	26 7/8"	4 9/16"	14 7/16"	25 5/8"	4"

**TRI-VIEW MEDICINE CABINET**

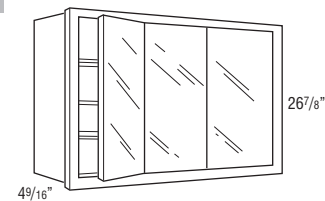

Model	1	2	3	4	5	6
<b>TV30</b>	1082	1082	1082	1082	1082	1082
<b>TV36</b>	1176	1176	1176	1176	1176	1176
<b>TV48</b>	1476	1476	1476	1476	1476	1476

- Cabinet has wood frame.
- Door of cabinet is glass mirror.
- Unit can be surface mounted or recessed.
- Finished exterior.
- Standard interior.
- Face frame has a profiled inside and outside edge.
- If ordered with Heirlooming Technique, will not feature sand-through characteristics.

Model	Cabinet Dimensions			Cut-out Dimensions		
	Width	Height	Depth	Width	Height	Depth
TV30	30"	26 7/8"	4 9/16"	28 11/16"	25 5/8"	4"
TV36	36"	26 7/8"	4 9/16"	34 11/16"	25 5/8"	4"
TV48	48"	26 7/8"	4 9/16"	46 11/16"	25 5/8"	4"

Model	7	8	9	10	11	12	13	14	15	16	17	18
<b>VMP2432.5</b>	1033	1033	1033	1033	1033	1033	1033	1033	1033	1033	1033	1033
<b>VMP3032.5</b>	1222	1222	1222	1222	1222	1222	1222	1222	1222	1222	1222	1222

MODIFICATIONS
No modifications available for these products.

Finish Techniques	
Distressing	Heirlooming
•	•

**Species Availability (Wood)**

Alder	Rustic Alder	Cherry	Rustic Hickory	Maple	Oak
		•		•	

**Species Availability (All Laminates)**

High Gloss	Horiz. Grain on Maple	Vert. Grain on Maple	Vert. Grain on Cherry	Vert. Grain on Oak
box color	box color	box color	box color	

Model	1	2	3	4	5	6	7	8	9	10	11	12	13	14	15	16	17	18
<b>VM2135</b>	807	807	807	807	807	807	807	807	807	807	807	807	807	807	807	807	807	807
<b>VM2735</b>	875	875	875	875	875	875	875	875	875	875	875	875	875	875	875	875	875	875
<b>VM3335</b>	954	954	954	954	954	954	954	954	954	954	954	954	954	954	954	954	954	954

MODIFICATIONS
No modifications available for these products.

Finish Techniques	
Distressing	Heirlooming
	•

**Species Availability (Wood)**

Alder	Rustic Alder	Cherry	Rustic Hickory	Maple	Oak
		•		•	

**Species Availability (All Laminates)**

High Gloss	Horiz. Grain on Maple	Vert. Grain on Maple	Vert. Grain on Cherry	Vert. Grain on Oak
box color	box color	box color	box color	

Model	1	2	3	4	5	6	7	8	9	10	11	12	13	14	15	16	17	18
<b>MC16</b>	934	934	934	934	934	934	934	934	934	934	934	934	934	934	934	934	934	934

**Custom Modifications**

AUTHL	AUTHR	CBO	CCO	CFNTO	CFP	CFRMO	CMAT	CND	DRWPWR	DRWTK	EXBKL	EXBKR	EXL	EXR	FB	FFDL	FFDR	FPEB	FTK	FTKAV	FTKFV	ID	INVFRM	LTI	MIP	RD	RECTKALL	RECTKBK	RECTKLR	RECTKR	RT	TKP	TOTSSS	VTK	WLI
		•	•	•		•									STD											•									•

**Construction Upgrades**

APC	PE
STD	

**Door Options**

ALF	CG	DPSRR	MD	MFO

Model	1	2	3	4	5	6	7	8	9	10	11	12	13	14	15	16	17	18
<b>TV30</b>	1082	1082	1082	1082	1082	1082	1082	1082	1082	1082	1082	1082	1082	1082	1082	1082	1082	1082
<b>TV36</b>	1176	1176	1176	1176	1176	1176	1176	1176	1176	1176	1176	1176	1176	1176	1176	1176	1176	1176
<b>TV48</b>	1476	1476	1476	1476	1476	1476	1476	1476	1476	1476	1476	1476	1476	1476	1476	1476	1476	1476

**Custom Modifications**

AUTHL	AUTHR	CBO	CCO	CFNTO	CFP	CFRMO	CMAT	CND	DRWPWR	DRWTK	EXBKL	EXBKR	EXL	EXR	FB	FFDL	FFDR	FPEB	FTK	FTKAV	FTKFV	ID	INVFRM	LTI	MIP	RD	RECTKALL	RECTKBK	RECTKLR	RECTKR	RT	TKP	TOTSSS	VTK	WLI
		•	•			•									STD											•									•

**Construction Upgrades**

APC	PE
STD	

**Door Options**

ALF	CG	DPSRR	MD	MFO

**SPECIES AVAILABILITY**

Species Availability charts list the availability of each product code by species and any substitutions that are made. Exceptions within a section are noted below the species availability chart.

For panels with doors and/or fillers attached, species availability is shown for the panel and filler only.

For Species Availability, look for this chart throughout. For trim items ordered with Laminates, trim items matching the cabinet box color are noted in the charts.

MDF door styles will use Maple for trim and panels, refer to Maple in the Species Availability charts.

**Species Availability (Wood)**

Alder	Rustic Alder	Cherry	Rustic Hickory	Maple	Oak
•	•	•	•	•	•

**Species Availability (All Laminates)**

High Gloss	Horiz. Grain on Maple	Vert. Grain on Maple	Vert. Grain on Cherry	Vert. Grain on Oak
box color	box color	box color	box color	box color

**DESCRIPTION MODEL PRICE**

**FILLERS**

**3" WIDE FILLERS**

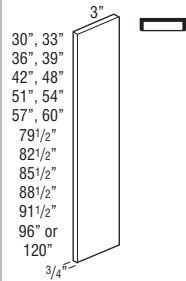

**F3**



<b>F330</b>	54
<b>F333</b>	61
<b>F336</b>	69
<b>F339</b>	77
<b>F342</b>	84
<b>F348</b>	98
<b>F351</b>	102
<b>F354</b>	105
<b>F357</b>	108
<b>F360</b>	112
<b>TF384</b>	119
<b>TF387</b>	133
<b>TF390</b>	147
<b>TF393</b>	176
<b>TF396</b>	176
<b>TF396FH</b>	220
<b>TF3120FH<sup>†</sup> ♦</b>	296

- 3/4" thick.
- Finished on front and all edges (backs are not finished).
- †5 day Express Response not available.

**Finish Techniques**

Distressing	Heirlooming
•	

**Species Availability (Wood)**

Alder	Rustic Alder	Cherry	Rustic Hickory	Maple	Oak
•	•	•	•	•	•

♦ Only available in Cherry and Maple.

**Species Availability (All Laminates)**

High Gloss	Horiz. Grain on Maple	Vert. Grain on Maple	Vert. Grain on Cherry	Vert. Grain on Oak
box color	box color	box color	box color	box color

♦ Only available in Cherry and Maple box colors.

**3" WIDE FILLER RETURN**

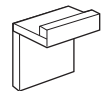

**F3R**



<b>F3R</b>	35
------------	----

- Creates a toekick appearance when used with 3" wide fillers.
- 3/8" thick, Natural Maple laminated furniture board.

**DESCRIPTION MODEL PRICE**

**3" WIDE CORNER FILLER**

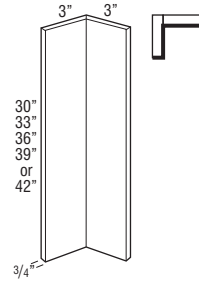

**CF3**



<b>CF330</b>	100
<b>CF333</b>	113
<b>CF336</b>	126
<b>CF339</b>	138
<b>CF342</b>	150

- 3/4" thick.
- Finished on front and all edges (backs are not finished).

**Finish Techniques**

Distressing	Heirlooming
•	

**Species Availability (Wood)**

Alder	Rustic Alder	Cherry	Rustic Hickory	Maple	Oak
•	•	•	•	•	•

**Species Availability (All Laminates)**

High Gloss	Horiz. Grain on Maple	Vert. Grain on Maple	Vert. Grain on Cherry	Vert. Grain on Oak
box color	box color	box color	box color	box color

**6" WIDE FILLERS**

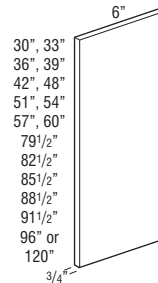

**F6**



<b>F630</b>	87
<b>F633</b>	97
<b>F636</b>	107
<b>F639</b>	118
<b>F642</b>	126
<b>F648</b>	184
<b>F651</b>	187
<b>F654</b>	194
<b>F657</b>	197
<b>F660</b>	200
<b>TF684</b>	207
<b>TF687</b>	233
<b>TF690</b>	256
<b>TF693</b>	300
<b>TF696</b>	300
<b>TF696FH</b>	377
<b>TF6120FH<sup>†</sup> ♦</b>	508

- 3/4" thick.
- Finished on front and all edges (backs are not finished).
- †5 day Express Response not available.

**Finish Techniques**

Distressing	Heirlooming
•	

**Species Availability (Wood)**

Alder	Rustic Alder	Cherry	Rustic Hickory	Maple	Oak
•	•	•	•	•	•

♦ Only available in Cherry and Maple.

**Species Availability (All Laminates)**

High Gloss	Horiz. Grain on Maple	Vert. Grain on Maple	Vert. Grain on Cherry	Vert. Grain on Oak
box color	box color	box color	box color	box color

♦ Only available in Cherry and Maple box colors.

**6" WIDE FILLER RETURN**

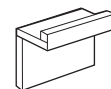

**F6R**



<b>F6R</b>	40
------------	----

- Creates a toekick appearance when used with 6" wide fillers.
- 3/8" thick, Natural Maple laminated furniture board.

Finished edges indicated by bold lines on side view drawings.  
Glazed edges indicated by arrows on side view drawings.



**DESCRIPTION**

**MODEL**

**PRICE**

**SPACE FILLERS**



**S96X14** (1/4" thick) 50

**S96X12** (1/2" thick) 66

- S96 is 1/4" or 1/2" thick.
- Designed to fill space between adjacent cabinets; i.e. W1830 butted against side of U188424.
- Finished on front and all edges (backs are not finished).

**Finish Techniques**

Distressing	Heirlooming
•	•

**Species Availability (Wood)**

Rustic Alder	Cherry	Rustic Hickory	Maple	Oak
•	•	•	•	•

**Species Availability (All Laminates)**

High Gloss	Horiz. Grain on Maple	Vert. Grain on Maple	Vert. Grain on Cherry	Vert. Grain on Oak
box color	box color	box color	box color	box color

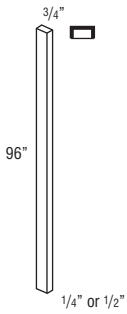

**DESCRIPTION**

**MODEL**

**PRICE**

**OVERLAY FILLER for MODIFIED FULL OVERLAY, 2 1/2" WIDE**



**OL312MFO** (10 3/4"H) 52

**OL315MFO** (13 3/4"H) 53

**OL318MFO** (16 3/4"H) 54

**OL321MFO** (19 3/4"H) 57

**OL324MFO** (22 3/4"H) 58

**OL327MFO** (25 3/4"H) 60

**OL330MFO** (28 3/4"H) 70

**OL333MFO** (31 3/4"H) 77

**OL336MFO** (34 3/4"H) 82

**OL339MFO** (37 3/4"H) 88

**OL342MFO** (40 3/4"H) 88

**OL384MFO** (78 1/4"H) 147

**OL387MFO** (81 1/4"H) 155

**OL390MFO** (84 1/4"H) 163

**OL393MFO** (87 1/4"H) 182

**OL396MFO** (90 1/4"H) 182

- All overlay fillers available in full overlay door styles except Herra and Prestley.
- Height will align with doors specified with Modified Full Overlay modification. See page 44 for MFO details.
- 2 1/2" wide overlay fillers can be applied to Wall Message Centers to create a custom finished look.
- Overlays match door profile and thickness.
- Finished on front and all edges (backs are not finished).
- Not available in MDF door styles.

**Finish Techniques**

Distressing	Heirlooming
•	•

**Species Availability (Wood)**

Rustic Alder	Cherry	Rustic Hickory	Maple	Oak
•	•	•	•	•

**Species Availability (All Laminates)**

High Gloss	Horiz. Grain on Maple	Vert. Grain on Maple	Vert. Grain on Cherry	Vert. Grain on Oak

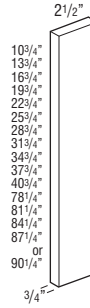

**OVERLAY FILLER, 2 1/2" WIDE**



**OL312** (11 1/2"H) 52

**OL315** (14 1/2"H) 53

**OL318** (17 1/2"H) 54

**OL321** (20 1/2"H) 57

**OL324** (23 1/2"H) 58

**OL327** (26 1/2"H) 60

**OL330** (28"H or 29 1/2"H) 70

**OL333** (31"H or 32 1/2"H) 77

**OL336** (34"H or 35 1/2"H) 82

**OL339** (37"H or 38 1/2"H) 88

**OL342** (40"H or 41 1/2"H) 88

**OL384** (79"H) 147

**OL387** (82"H) 155

**OL390** (85"H) 163

**OL393** (88"H) 182

**OL396** (91"H) 182

**VOL332** (27"H) 60

**DOL329** (24"H) 60

- All overlay fillers available in full overlay door styles.
- OL330, OL333, OL336, OL339, OL342 also available in partial overlay door styles. Overlays for partial overlay door styles will match partial overlay door height.
- 2 1/2" wide overlay fillers can be applied to Wall Message Centers to create custom finished look.
- Overlays match door profile and thickness.
- See pages 8-9 for list of full overlay styles.
- Finished on front and all edges (backs are not finished).
- See OL\_\_MFO (on right) for use with Modified Full Overlay modification.
- Maple will be used for MDF overlays.

**Finish Techniques**

Distressing	Heirlooming
•	•

**Species Availability (Wood)**

Rustic Alder	Cherry	Rustic Hickory	Maple	Oak
•	•	•	•	•

**Species Availability (All Laminates)**

High Gloss	Horiz. Grain on Maple	Vert. Grain on Maple	Vert. Grain on Cherry	Vert. Grain on Oak

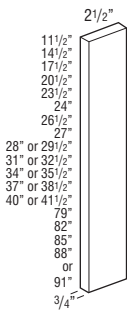

Finished edges indicated by bold lines on side view drawings.  
Glazed edges indicated by arrows on side view drawings.

**DESCRIPTION MODEL PRICE**

**OVERLAY FILLER, PREMIUM, 2 1/2" WIDE**

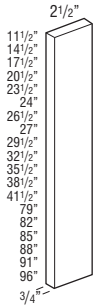

<b>OL312P</b> (11 1/2"H)	105
<b>OL315P</b> (14 1/2"H)	107
<b>OL318P</b> (17 1/2"H)	109
<b>OL321P</b> (20 1/2"H)	115
<b>OL324P</b> (23 1/2"H)	117
<b>OL327P</b> (26 1/2"H)	121
<b>OL330P</b> (29 1/2"H)	140
<b>OL333P</b> (32 1/2"H)	153
<b>OL336P</b> (35 1/2"H)	163
<b>OL339P</b> (38 1/2"H)	176
<b>OL342P</b> (41 1/2"H)	176
<b>OL384P</b> (79"H)	293
<b>OL387P</b> (82"H)	309
<b>OL390P</b> (85"H)	327
<b>OL393P</b> (88"H)	364
<b>OL396P</b> (91"H)	364
<b>OL396FHP</b> (96"H)	382
<b>VOL332P</b> (27"H)	121
<b>DOL329P</b> (24"H)	121

- Overlays match door profile and thickness.
- Front, edges, and backs match door and drawer front construction.
- Aspen edgebanding will match door and drawer front edgebanding selection.
- Derazi overlays feature horizontal grain. Overlays greater than 48" high will be two overlays and require field assembly (allow 3/16" gap between overlays for alignment with adjacent doors).

**Finish Techniques**

Distressing	Heirlooming

**Species Availability (Wood)**

Alder	Rustic Alder	Cherry	Rustic Hickory	Maple	Oak

**Species Availability (All Laminates)**

High Gloss	Horiz. Grain on Maple	Vert. Grain on Maple	Vert. Grain on Cherry	Vert. Grain on Oak
•	•	•	•	•

**DESCRIPTION MODEL PRICE**

**OVERLAY FILLER for MODIFIED FULL OVERLAY, PREMIUM, 2 1/2" WIDE**

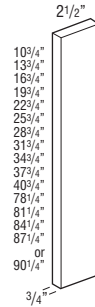

<b>OL312MFOP</b> (10 3/4"H)	105
<b>OL315MFOP</b> (13 3/4"H)	107
<b>OL318MFOP</b> (16 3/4"H)	109
<b>OL321MFOP</b> (19 3/4"H)	115
<b>OL324MFOP</b> (22 3/4"H)	117
<b>OL327MFOP</b> (25 3/4"H)	121
<b>OL330MFOP</b> (28 3/4"H)	140
<b>OL333MFOP</b> (31 3/4"H)	153
<b>OL336MFOP</b> (34 3/4"H)	163
<b>OL339MFOP</b> (37 3/4"H)	176
<b>OL342MFOP</b> (40 3/4"H)	176
<b>OL384MFOP</b> (78 1/4"H)	293
<b>OL387MFOP</b> (81 1/4"H)	309
<b>OL390MFOP</b> (84 1/4"H)	327
<b>OL393MFOP</b> (87 1/4"H)	364
<b>OL396MFOP</b> (90 1/4"H)	364

- Overlays match door profile and thickness.
- Front, edges, and backs match door and drawer front construction.
- Height will align with doors specified with Modified Full Overlay modification. See page 44 for MFO details.
- Aspen edgebanding will match door and drawer front edgebanding selection.
- Derazi overlays feature horizontal grain. Overlays greater than 48" high will be two overlays and require field assembly (allow 3/16" gap between overlays for alignment with adjacent doors).

**Finish Techniques**

Distressing	Heirlooming

**Species Availability (Wood)**

Alder	Rustic Alder	Cherry	Rustic Hickory	Maple	Oak

**Species Availability (All Laminates)**

High Gloss	Horiz. Grain on Maple	Vert. Grain on Maple	Vert. Grain on Cherry	Vert. Grain on Oak
•	•	•	•	•

**DESCRIPTION**

**OVERLAY FILLER,  
5 1/2" WIDE**

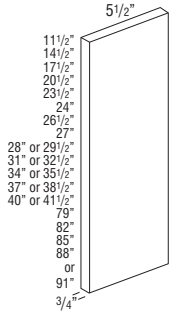

**MODEL**

**PRICE**

<b>OL612</b> (11 1/2"H)	88
<b>OL615</b> (14 1/2"H)	91
<b>OL618</b> (17 1/2"H)	92
<b>OL621</b> (20 1/2"H)	93
<b>OL624</b> (23 1/2"H)	94
<b>OL627</b> (26 1/2"H)	98
<b>OL630</b> (28"H or 29 1/2"H)	99
<b>OL633</b> (31"H or 32 1/2"H)	116
<b>OL636</b> (34"H or 35 1/2"H)	132
<b>OL639</b> (37"H or 38 1/2"H)	145
<b>OL642</b> (40"H or 41 1/2"H)	147
<b>OL684</b> (79"H)	244
<b>OL687</b> (82"H)	263
<b>OL690</b> (85"H)	285
<b>OL693</b> (88"H)	300
<b>OL696</b> (91"H)	300
<b>VOL632</b> (27"H)	98
<b>DOL629</b> (24"H)	99

- All overlay fillers available in full overlay door styles.
- OL630, OL633, OL636, OL639, OL642 also available in partial overlay door styles. Overlays for partial overlay door styles will match partial overlay door height.
- Overlays match door profile and thickness.
- See pages 8-9 for list of full overlay styles.
- Finished on front and all edges (backs are not finished).
- See OL\_ \_MFO (on right) for use with Modified Full Overlay modification.
- Maple will be used for MDF overlays.

**Finish Techniques**

Distressing	Heirlooming
•	•

**Species Availability (Wood)**

Alder	Rustic Alder	Cherry	Rustic Hickory	Maple	Oak
•	•	•	•	•	•

**Species Availability (All Laminates)**

High Gloss	Horiz. Grain on Maple	Vert. Grain on Maple	Vert. Grain on Cherry	Vert. Grain on Oak

**DESCRIPTION**

**OVERLAY FILLER  
for MODIFIED FULL  
OVERLAY, 5 1/2" WIDE**

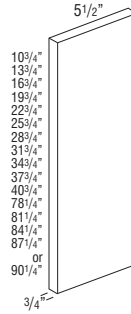

**MODEL**

**PRICE**

<b>OL612MFO</b> (10 3/4"H)	88
<b>OL615MFO</b> (13 3/4"H)	91
<b>OL618MFO</b> (16 3/4"H)	92
<b>OL621MFO</b> (19 3/4"H)	93
<b>OL624MFO</b> (22 3/4"H)	94
<b>OL627MFO</b> (25 3/4"H)	98
<b>OL630MFO</b> (28 3/4"H)	99
<b>OL633MFO</b> (31 3/4"H)	116
<b>OL636MFO</b> (34 3/4"H)	132
<b>OL639MFO</b> (37 3/4"H)	145
<b>OL642MFO</b> (40 3/4"H)	147
<b>OL684MFO</b> (78 1/4"H)	244
<b>OL687MFO</b> (81 1/4"H)	263
<b>OL690MFO</b> (84 1/4"H)	285
<b>OL693MFO</b> (87 1/4"H)	300
<b>OL696MFO</b> (90 1/4"H)	300

- All overlay fillers available in full overlay door styles except Herra and Prestley.
- Height will align with doors specified with Modified Full Overlay modification. See page 44 for MFO details.
- Overlays match door profile and thickness.
- Finished on front and all edges (backs are not finished).
- Not available in MDF door styles.

**Finish Techniques**

Distressing	Heirlooming
•	•

**Species Availability (Wood)**

Alder	Rustic Alder	Cherry	Rustic Hickory	Maple	Oak
•	•	•	•	•	•

**Species Availability (All Laminates)**

High Gloss	Horiz. Grain on Maple	Vert. Grain on Maple	Vert. Grain on Cherry	Vert. Grain on Oak

**DESCRIPTION MODEL PRICE**

**OVERLAY FILLER, PREMIUM, 5 1/2" WIDE**

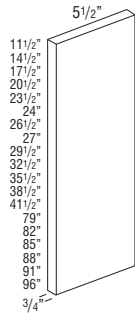

<b>OL612P</b> (11 1/2"H)	176
<b>OL615P</b> (14 1/2"H)	182
<b>OL618P</b> (17 1/2"H)	184
<b>OL621P</b> (20 1/2"H)	186
<b>OL624P</b> (23 1/2"H)	189
<b>OL627P</b> (26 1/2"H)	197
<b>OL630P</b> (29 1/2"H)	199
<b>OL633P</b> (32 1/2"H)	233
<b>OL636P</b> (35 1/2"H)	263
<b>OL639P</b> (38 1/2"H)	291
<b>OL642P</b> (41 1/2"H)	293
<b>OL684P</b> (79"H)	488
<b>OL687P</b> (82"H)	528
<b>OL690P</b> (85"H)	570
<b>OL693P</b> (88"H)	600
<b>OL696P</b> (91"H)	600
<b>OL696FHP</b> (96"H)	631
<b>VOL632P</b> (27"H)	197
<b>DOL629P</b> (24"H)	199

- Overlays match door profile and thickness.
- Front, edges, and backs match door and drawer front construction.
- Aspen edgebanding will match door and drawer front edgebanding selection.
- Derazi overlays feature horizontal grain. Overlays greater than 48" high will be two overlays and require field assembly (allow 3/16" gap between overlays for alignment with adjacent doors).

**Finish Techniques**

Distressing	Heirlooming

**Species Availability (Wood)**

Alder	Rustic Alder	Cherry	Rustic Hickory	Maple	Oak

**Species Availability (All Laminates)**

High Gloss	Horiz. Grain on Maple	Vert. Grain on Maple	Vert. Grain on Cherry	Vert. Grain on Oak
•	•	•	•	•

**DESCRIPTION MODEL PRICE**

**OVERLAY FILLER for MODIFIED FULL OVERLAY, PREMIUM, 5 1/2" WIDE**

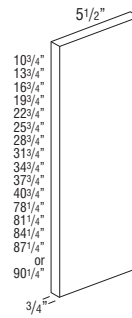

<b>OL612MFOP</b> (10 3/4"H)	176
<b>OL615MFOP</b> (13 3/4"H)	182
<b>OL618MFOP</b> (16 3/4"H)	184
<b>OL621MFOP</b> (19 3/4"H)	186
<b>OL624MFOP</b> (22 3/4"H)	189
<b>OL627MFOP</b> (25 3/4"H)	197
<b>OL630MFOP</b> (28 3/4"H)	199
<b>OL633MFOP</b> (31 3/4"H)	233
<b>OL636MFOP</b> (34 3/4"H)	263
<b>OL639MFOP</b> (37 3/4"H)	291
<b>OL642MFOP</b> (40 3/4"H)	293
<b>OL684MFOP</b> (78 1/4"H)	488
<b>OL687MFOP</b> (81 1/4"H)	528
<b>OL690MFOP</b> (84 1/4"H)	570
<b>OL693MFOP</b> (87 1/4"H)	600
<b>OL696MFOP</b> (90 1/4"H)	600

- Overlays match door profile and thickness.
- Front, edges, and backs match door and drawer front construction.
- Height will align with doors specified with Modified Full Overlay modification. See page 44 for MFO details.
- Aspen edgebanding will match door and drawer front edgebanding selection.
- Derazi overlays feature horizontal grain. Overlays greater than 48" high will be two overlays and require field assembly (allow 3/16" gap between overlays for alignment with adjacent doors).

**Finish Techniques**

Distressing	Heirlooming

**Species Availability (Wood)**

Alder	Rustic Alder	Cherry	Rustic Hickory	Maple	Oak

**Species Availability (All Laminates)**

High Gloss	Horiz. Grain on Maple	Vert. Grain on Maple	Vert. Grain on Cherry	Vert. Grain on Oak
•	•	•	•	•

**DESCRIPTION**

**MODEL**

**PRICE**

**FLUTED/BEADED 3" WIDE REVERSIBLE FILLERS**



<b>FBF330</b> (3" x 30")	166
<b>FBF336</b> (3" x 36")	173
<b>TBF396</b> (3" x 96")	296

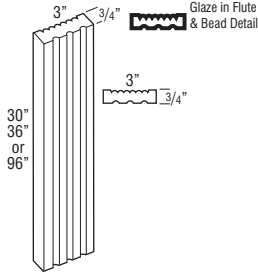

**Finish Techniques**

Distressing	Heirlooming
	•

**Species Availability (Wood)**

	Rustic Alder	Cherry	Rustic Hickory	Maple	Oak
•	Alder	•	Hickory	•	•

**Species Availability (All Laminates)**

High Gloss	Horiz. Grain on Maple	Vert. Grain on Maple	Vert. Grain on Cherry	Vert. Grain on Oak
box color	box color	box color	box color	box color

**FLUTED/BEADED 6" WIDE REVERSIBLE FILLERS**



<b>FBF630</b> (6" x 30")	183
<b>FBF636</b> (6" x 36")	193
<b>TBF696</b> (6" x 96")	329

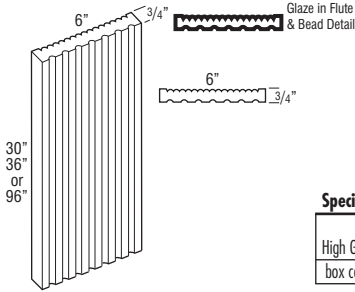

**Finish Techniques**

Distressing	Heirlooming
	•

**Species Availability (Wood)**

	Rustic Alder	Cherry	Rustic Hickory	Maple	Oak
•	Alder	•	Hickory	•	•

**Species Availability (All Laminates)**

High Gloss	Horiz. Grain on Maple	Vert. Grain on Maple	Vert. Grain on Cherry	Vert. Grain on Oak
box color	box color	box color	box color	box color

**ANGLED FLUTED/PLAIN 3" WIDE REVERSIBLE FILLERS**



<b>BLVDF30</b> (3" x 30")	187
<b>BLVDF34.5</b> (3" x 34 1/2")	275
<b>BLVDTFF96</b> (3" x 96")	504

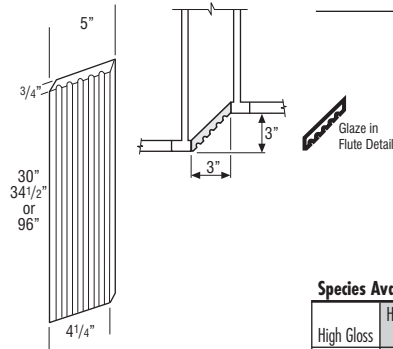

**Finish Techniques**

Distressing	Heirlooming
	•

**Species Availability (Wood)**

	Rustic Alder	Cherry	Rustic Hickory	Maple	Oak
•	Alder	•	Hickory	•	•

**Species Availability (All Laminates)**

High Gloss	Horiz. Grain on Maple	Vert. Grain on Maple	Vert. Grain on Cherry	Vert. Grain on Oak
box color	box color	box color	box color	box color

**DESCRIPTION**

**MODEL**

**PRICE**

**NEW BOX COLUMN FILLERS, 1 1/2" WIDE Wall - Plain Column 15" Deep**

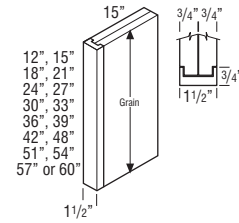

**Plain**

<b>W1.512BCFP</b>	345
<b>W1.515BCFP</b>	361
<b>W1.518BCFP</b>	382
<b>W1.521BCFP</b>	402
<b>W1.524BCFP</b>	423
<b>W1.527BCFP</b>	445
<b>W1.530BCFP</b>	467
<b>W1.533BCFP</b>	486
<b>W1.536BCFP</b>	504
<b>W1.539BCFP</b>	541
<b>W1.542BCFP</b>	541
<b>W1.548BCFP</b>	614
<b>W1.551BCFP</b>	650
<b>W1.554BCFP</b>	686
<b>W1.557BCFP</b>	755
<b>W1.560BCFP</b>	757

- Available in 1" depth increments from 6" to 27".
- Reversible, may be used on either left or right end.
- Front and both sides finished. Top, bottom, and back are unfinished.
- Plywood construction.
- Finished veneer on end panel exterior.

**Custom Modifications**

ID	RD
•	•

**Finish Techniques**

Distressing	Heirlooming
•	

**Species Availability (Wood)**

	Rustic Alder	Cherry	Rustic Hickory	Maple	Oak
•	Alder	•	Hickory	•	•

**Species Availability (All Laminates)**

High Gloss	Horiz. Grain on Maple	Vert. Grain on Maple	Vert. Grain on Cherry	Vert. Grain on Oak
box color	box color	box color	box color	box color

Finished edges indicated by bold lines on side view drawings.  
Glazed edges indicated by arrows on side view drawings.

**DESCRIPTION MODEL PRICE**

**BOX COLUMN FILLERS, 3" WIDE**  
**Wall - Plain Column**  
**15" Deep**

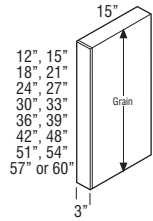

Plain

W312BCFP	345
W315BCFP	361
W318BCFP	382
W321BCFP	402
W324BCFP	423
W327BCFP	445
W330BCFP	467
W333BCFP	486
W336BCFP	504
W339BCFP	541
W342BCFP	541
W348BCFP	614
W351BCFP	650
W354BCFP	686
W357BCFP	755
W360BCFP	757

- Available in 1" depth increments from 6" to 27".
- Reversible, may be used on either left or right end.
- Front and both sides finished.
- Enclosed top and bottom (not finished).
- 1/2" plywood construction.
- Finished veneer on end panel exterior.
- No reveal on filler.
- Not intended for use horizontally as shelving. Use Floating Shelves on page 569.

Custom Modifications		Finish Techniques	
ID	RD	Distressing	Heirlooming
•	•		•

**Species Availability (Wood)**

Alder	Rustic Alder	Cherry	Rustic Hickory	Maple	Oak
•	Alder	•	Hickory	•	•

**Species Availability (All Laminates)**

High Gloss	Horiz. Grain on Maple	Vert. Grain on Maple	Vert. Grain on Cherry	Vert. Grain on Oak
box color	box color	box color	box color	box color

**DESCRIPTION MODEL PRICE**

**BOX COLUMN FILLERS, 3" WIDE**  
**Wall - Fluted, Beaded Column**  
**15" Deep**

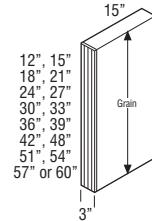

Fluted

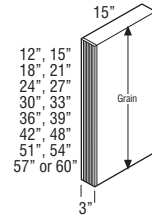

Beaded

W312BCFF	400
W315BCFF	420
W318BCFF	442
W321BCFF	465
W324BCFF	488
W327BCFF	515
W330BCFF	541
W333BCFF	558
W336BCFF	577
W339BCFF	614
W342BCFF	614
W348BCFF	686
W351BCFF	721
W354BCFF	757
W357BCFF	830
W360BCFF	830

W312BCFB	400
W315BCFB	420
W318BCFB	442
W321BCFB	465
W324BCFB	488
W327BCFB	515
W330BCFB	541
W333BCFB	558
W336BCFB	577
W339BCFB	614
W342BCFB	614
W348BCFB	686
W351BCFB	721
W354BCFB	757
W357BCFB	830
W360BCFB	830

- Available in 1" depth increments from 6" to 27".
- Reversible, may be used on either left or right end.
- Front and both sides finished.
- Enclosed top and bottom (not finished).
- 1/2" plywood construction.
- Finished veneer on end panel exterior.
- No reveal on filler.
- W3\_\_BCFF have Fluted fillers. W3\_\_BCFB have Beaded fillers.
- Not intended for use horizontally as shelving. Use Floating Shelves on page 569.

Custom Modifications		Finish Techniques	
ID	RD	Distressing	Heirlooming
•	•		•

**Species Availability (Wood)**

Alder	Rustic Alder	Cherry	Rustic Hickory	Maple	Oak
•	Alder	•	Hickory	•	•

**Species Availability (All Laminates)**

High Gloss	Horiz. Grain on Maple	Vert. Grain on Maple	Vert. Grain on Cherry	Vert. Grain on Oak
box color	box color	box color	box color	box color

**DESCRIPTION**

**NEW** **BOX COLUMN FILLERS, 1 1/2" WIDE Base - Plain Column 27" Deep**

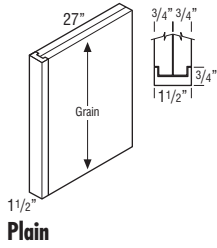

**Plain**

**MODEL**

**B1.534.527BCFP**

**PRICE**

**852**

- Available in 1" depth increments from 6" to 27".
- Reversible, may be used on either left or right end.
- Front and both sides finished. Top, bottom, and back are unfinished.
- Plywood construction.
- Finished veneer on end panel exterior.

**Custom Modifications**

ID	RD
	•

**Finish Techniques**

Distressing	Heirlooming
•	

**Species Availability (Wood)**

Alder	Rustic Alder	Cherry	Rustic Hickory	Maple	Oak
•	Alder	•	Hickory	•	•

**Species Availability (All Laminates)**

High Gloss box color	Horiz. Grain on Maple box color	Vert. Grain on Maple box color	Vert. Grain on Cherry box color	Vert. Grain on Oak box color

**BOX COLUMN FILLERS, 3" WIDE Base - Plain Column 27" Deep**

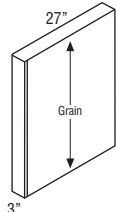

**Plain**

**B334.527BCFP**

**852**

- Available in 1" depth increments from 6" to 27".
- Reversible, may be used on either left or right end.
- Front and both sides finished.
- Enclosed top and bottom (not finished).
- 1/2" plywood construction.
- Finished veneer on end panel exterior.
- No reveal on filler.
- Not intended for use horizontally as shelving. Use Floating Shelves on page 569.

**Custom Modifications**

ID	RD
	•

**Finish Techniques**

Distressing	Heirlooming
•	

**Species Availability (Wood)**

Alder	Rustic Alder	Cherry	Rustic Hickory	Maple	Oak
•	Alder	•	Hickory	•	•

**Species Availability (All Laminates)**

High Gloss box color	Horiz. Grain on Maple box color	Vert. Grain on Maple box color	Vert. Grain on Cherry box color	Vert. Grain on Oak box color

**BOX COLUMN FILLERS, 3" WIDE Base - Fluted, Beaded Column 27" Deep**

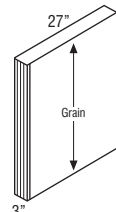

**Fluted**

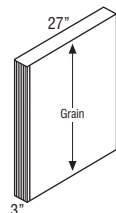

**Beaded**

**B334.527BCFF**

**937**

- Available in 1" depth increments from 6" to 27".
- Reversible, may be used on either left or right end.
- Front and both sides finished.
- Enclosed top and bottom (not finished).
- 1/2" plywood construction.
- Finished veneer on end panel exterior.
- No reveal on filler.
- B334.527BCFF have Fluted fillers. B334.527BCFP have Beaded fillers.
- Not intended for use horizontally as shelving. Use Floating Shelves on page 569.

**Custom Modifications**

ID	RD
	•

**Finish Techniques**

Distressing	Heirlooming
	•

**Species Availability (Wood)**

Alder	Rustic Alder	Cherry	Rustic Hickory	Maple	Oak
•	Alder	•	Hickory	•	•

**Species Availability (All Laminates)**

High Gloss box color	Horiz. Grain on Maple box color	Vert. Grain on Maple box color	Vert. Grain on Cherry box color	Vert. Grain on Oak box color

**DESCRIPTION**

**NEW** **BOX COLUMN FILLERS, 1 1/2" WIDE Tall - Plain Column 15" & 27" Deep**

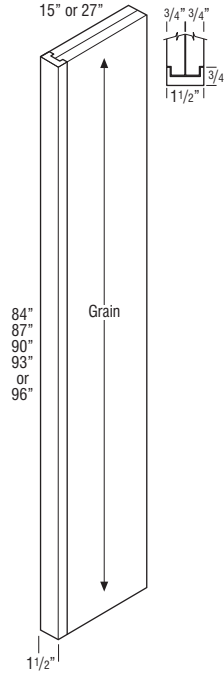

**Plain**

**MODEL**

**T1.58415BCFP (15" Deep)**

**PRICE**

**1096**

**T1.58715BCFP (15" Deep)**

**1103**

**T1.59015BCFP (15" Deep)**

**1112**

**T1.59315BCFP (15" Deep)**

**1133**

**T1.59615BCFP (15" Deep)**

**1133**

**T1.58427BCFP (27" Deep)**

**1682**

**T1.58727BCFP (27" Deep)**

**1694**

**T1.59027BCFP (27" Deep)**

**1708**

**T1.59327BCFP (27" Deep)**

**1725**

**T1.59627BCFP (27" Deep)**

**1725**

- Available in 1" depth increments from 6" to 27".
- Reversible, may be used on either left or right end.
- Front and both sides finished. Top, bottom, and back are unfinished.
- Plywood construction.
- Finished veneer on end panel exterior.

**Custom Modifications**

ID	RD
•*	•

**Finish Techniques**

Distressing	Heirlooming
•	

\*ID only available on 15" deep.

**Species Availability (Wood)**

Alder	Rustic Alder	Cherry	Rustic Hickory	Maple	Oak
•	Alder	•	Hickory	•	•

**Species Availability (All Laminates)**

High Gloss box color	Horiz. Grain on Maple box color	Vert. Grain on Maple box color	Vert. Grain on Cherry box color	Vert. Grain on Oak box color

**BOX COLUMN FILLERS, 3" WIDE Tall - Plain Column 15" & 27" Deep**

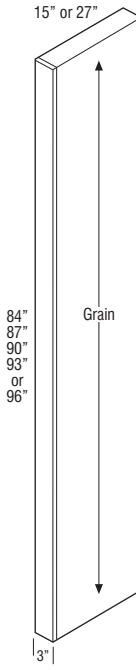

**Plain**

**T38415BCFP (15" Deep)**

**1096**

**T38715BCFP (15" Deep)**

**1103**

**T39015BCFP (15" Deep)**

**1112**

**T39315BCFP (15" Deep)**

**1133**

**T39615BCFP (15" Deep)**

**1133**

**T38427BCFP (27" Deep)**

**1682**

**T38727BCFP (27" Deep)**

**1694**

**T39027BCFP (27" Deep)**

**1708**

**T39327BCFP (27" Deep)**

**1725**

**T39627BCFP (27" Deep)**

**1725**

- Available in 1" depth increments from 6" to 27".
- Reversible, may be used on either left or right end.
- Front and both sides finished.
- Enclosed top and bottom (not finished).
- 1/2" plywood construction.
- Finished veneer on end panel exterior.
- No reveal on filler.
- Not intended for use horizontally as shelving. Use Floating Shelves on page 569.

**Custom Modifications**

ID	RD
•*	•

**Finish Techniques**

Distressing	Heirlooming
•	

\*ID only available on 15" deep.

**Species Availability (Wood)**

Alder	Rustic Alder	Cherry	Rustic Hickory	Maple	Oak
•	Alder	•	Hickory	•	•

**Species Availability (All Laminates)**

High Gloss box color	Horiz. Grain on Maple box color	Vert. Grain on Maple box color	Vert. Grain on Cherry box color	Vert. Grain on Oak box color

**DESCRIPTION**

**MODEL**

**PRICE**

**BOX COLUMN FILLERS, 3" WIDE  
Tall - Fluted, Beaded Column  
15" & 27" Deep**

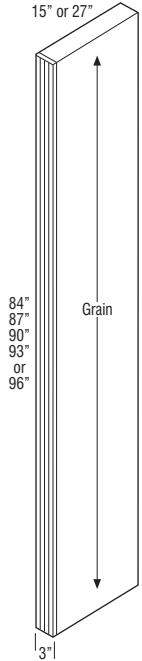

**Fluted**

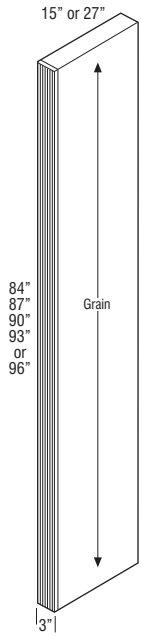

**Beaded**

<b>T38415BCFF</b> (15" Deep)	1189
<b>T38715BCFF</b> (15" Deep)	1204
<b>T39015BCFF</b> (15" Deep)	1219
<b>T39315BCFF</b> (15" Deep)	1248
<b>T39615BCFF</b> (15" Deep)	1248
<b>T38427BCFF</b> (27" Deep)	1768
<b>T38727BCFF</b> (27" Deep)	1786
<b>T39027BCFF</b> (27" Deep)	1802
<b>T39327BCFF</b> (27" Deep)	1840
<b>T39627BCFF</b> (27" Deep)	1840

<b>T38415BCFB</b> (15" Deep)	1189
<b>T38715BCFB</b> (15" Deep)	1204
<b>T39015BCFB</b> (15" Deep)	1219
<b>T39315BCFB</b> (15" Deep)	1248
<b>T39615BCFB</b> (15" Deep)	1248
<b>T38427BCFB</b> (27" Deep)	1768
<b>T38727BCFB</b> (27" Deep)	1786
<b>T39027BCFB</b> (27" Deep)	1802
<b>T39327BCFB</b> (27" Deep)	1840
<b>T39627BCFB</b> (27" Deep)	1840

- Available in 1" depth increments from 6" to 27".
- Reversible, may be used on either left or right end.
- Front and both sides finished.
- Enclosed top and bottom (not finished).
- 1/2" plywood construction.
- Finished veneer on end panel exterior.
- No reveal on filler.
- T3\_ \_BCFF have Fluted fillers. T3\_ \_BCFB have Beaded fillers.
- Not intended for use horizontally as shelving. Use Floating Shelves on page 569.

**Custom Modifications**

ID	RD
•*	•

\*ID only available on 15" deep.

**Finish Techniques**

Distressing	Heirlooming
	•

**Species Availability (Wood)**

Alder	Rustic Alder	Cherry	Rustic Hickory	Maple	Oak
•	•	•	•	•	•

**Species Availability (All Laminates)**

High Gloss	Horiz. Grain on Maple	Vert. Grain on Maple	Vert. Grain on Cherry	Vert. Grain on Oak
box color	box color	box color	box color	box color

**DESCRIPTION**

**MODEL**

**PRICE**

**BOX COLUMN FILLERS, 6" WIDE  
Wall - Plain Column  
15" Deep**

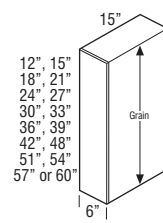

**Plain**

<b>W612BCFP</b>	382
<b>W615BCFP</b>	403
<b>W618BCFP</b>	425
<b>W621BCFP</b>	446
<b>W624BCFP</b>	468
<b>W627BCFP</b>	493
<b>W630BCFP</b>	518
<b>W633BCFP</b>	539
<b>W636BCFP</b>	560
<b>W639BCFP</b>	601
<b>W642BCFP</b>	601
<b>W648BCFP</b>	680
<b>W651BCFP</b>	721
<b>W654BCFP</b>	762
<b>W657BCFP</b>	836
<b>W660BCFP</b>	839

- Available in 1" depth increments from 6" to 27".
- Reversible, may be used on either left or right end.
- Front and both sides finished.
- Enclosed top and bottom (not finished).
- 1/2" plywood construction.
- Finished veneer on end panel exterior.
- No reveal on filler.
- Not intended for use horizontally as shelving. Use Floating Shelves on page 569.

**Custom Modifications**

ID	RD
•	•

**Finish Techniques**

Distressing	Heirlooming
•	

**Species Availability (Wood)**

Alder	Rustic Alder	Cherry	Rustic Hickory	Maple	Oak
•	•	•	•	•	•

**Species Availability (All Laminates)**

High Gloss	Horiz. Grain on Maple	Vert. Grain on Maple	Vert. Grain on Cherry	Vert. Grain on Oak
box color	box color	box color	box color	box color



**DESCRIPTION**

**MODEL**

**PRICE**

**BOX COLUMN FILLERS, 6" WIDE**  
**Wall - Fluted, Beaded Column**  
**15" Deep**

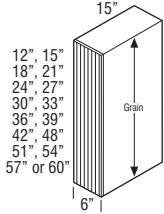

**Fluted**

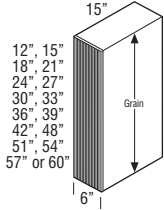

**Beaded**

W612BCFF	443
W615BCFF	466
W618BCFF	490
W621BCFF	516
W624BCFF	542
W627BCFF	573
W630BCFF	601
W633BCFF	621
W636BCFF	639
W639BCFF	680
W642BCFF	680
W648BCFF	762
W651BCFF	803
W654BCFF	839
W657BCFF	921
W660BCFF	921
W612BCFB	443
W615BCFB	466
W618BCFB	490
W621BCFB	516
W624BCFB	542
W627BCFB	573
W630BCFB	601
W633BCFB	621
W636BCFB	639
W639BCFB	680
W642BCFB	680
W648BCFB	762
W651BCFB	803
W654BCFB	839
W657BCFB	921
W660BCFB	921

- Available in 1" depth increments from 6" to 27".
- Reversible, may be used on either left or right end.
- Front and both sides finished.
- Enclosed top and bottom (not finished).
- 1/2" plywood construction.
- Finished veneer on end panel exterior.
- No reveal on filler.
- W6\_\_BCFF have Fluted fillers. W6\_\_BCFB have Beaded fillers.
- Not intended for use horizontally as shelving. Use Floating Shelves on page 569.

**Custom Modifications**

ID	RD
•	•

**Finish Techniques**

Distressing	Heirlooming
	•

**Species Availability (Wood)**

Alder	Rustic Alder	Cherry	Rustic Hickory	Maple	Oak
•	Alder	•	Hickory	•	•

**Species Availability (All Laminates)**

High Gloss	Horiz. Grain on Maple	Vert. Grain on Maple	Vert. Grain on Cherry	Vert. Grain on Oak
box color	box color	box color	box color	box color

**DESCRIPTION**

**MODEL**

**PRICE**

**BOX COLUMN FILLERS, 6" WIDE**  
**Base - Plain Column**  
**27" Deep**

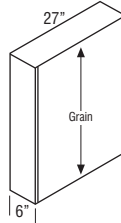

**Plain**

- Available in 1" depth increments from 6" to 27".
- Reversible, may be used on either left or right end.
- Front and both sides finished.
- Enclosed top and bottom (not finished).
- 1/2" plywood construction.
- Finished veneer on end panel exterior.
- No reveal on filler.
- Not intended for use horizontally as shelving. Use Floating Shelves on page 569.

**Custom Modifications**

ID	RD
	•

**Finish Techniques**

Distressing	Heirlooming
•	

**Species Availability (Wood)**

Alder	Rustic Alder	Cherry	Rustic Hickory	Maple	Oak
•	Alder	•	Hickory	•	•

**Species Availability (All Laminates)**

High Gloss	Horiz. Grain on Maple	Vert. Grain on Maple	Vert. Grain on Cherry	Vert. Grain on Oak
box color	box color	box color	box color	box color

**BOX COLUMN FILLERS, 6" WIDE**  
**Base - Fluted, Beaded Column**  
**27" Deep**

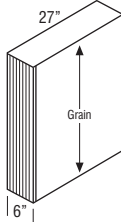

**Fluted**

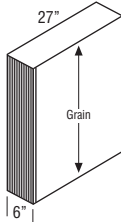

**Beaded**

**B634.527BCFF** 1041

**B634.527BCFB** 1041

- Available in 1" depth increments from 6" to 27".
- Reversible, may be used on either left or right end.
- Front and both sides finished.
- Enclosed top and bottom (not finished).
- 1/2" plywood construction.
- Finished veneer on end panel exterior.
- No reveal on filler.
- B634.527BCFF have Fluted fillers. B634.527BCFB have Beaded fillers.
- Not intended for use horizontally as shelving. Use Floating Shelves on page 569.

**Custom Modifications**

ID	RD
	•

**Finish Techniques**

Distressing	Heirlooming
	•

**Species Availability (Wood)**

Alder	Rustic Alder	Cherry	Rustic Hickory	Maple	Oak
•	Alder	•	Hickory	•	•

**Species Availability (All Laminates)**

High Gloss	Horiz. Grain on Maple	Vert. Grain on Maple	Vert. Grain on Cherry	Vert. Grain on Oak
box color	box color	box color	box color	box color

**DESCRIPTION**

**MODEL**

**PRICE**

**BOX COLUMN FILLERS, 6" WIDE**  
**Tall - Plain Column**  
**15" & 27" Deep**

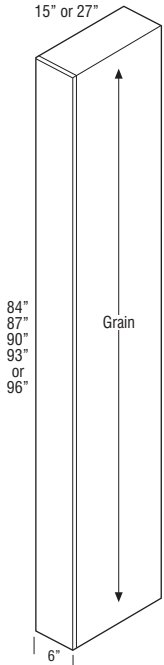

Plain

<b>T68415BCFP</b> (15" Deep)	1217
<b>T68715BCFP</b> (15" Deep)	1224
<b>T69015BCFP</b> (15" Deep)	1231
<b>T69315BCFP</b> (15" Deep)	1256
<b>T69615BCFP</b> (15" Deep)	1256
<b>T68427BCFP</b> (27" Deep)	1865
<b>T68727BCFP</b> (27" Deep)	1883
<b>T69027BCFP</b> (27" Deep)	1896
<b>T69327BCFP</b> (27" Deep)	1914
<b>T69627BCFP</b> (27" Deep)	1914

- Available in 1" depth increments from 6" to 27".
- Reversible, may be used on either left or right end.
- Front and both sides finished.
- Enclosed top and bottom (not finished).
- 1/2" plywood construction.
- Finished veneer on end panel exterior.
- No reveal on filler.
- Not intended for use horizontally as shelving. Use Floating Shelves on page 569.

**Custom Modifications**

ID	RD
•*	•

**Finish Techniques**

Distressing	Heirlooming
•	•

\*ID only available on 15" deep.

**Species Availability (Wood)**

Alder	Rustic Alder	Cherry	Rustic Hickory	Maple	Oak
•	Alder	•	Hickory	•	•

**Species Availability (All Laminates)**

High Gloss	Horiz. Grain on Maple	Vert. Grain on Maple	Vert. Grain on Cherry	Vert. Grain on Oak
box color	box color	box color	box color	box color

**DESCRIPTION**

**MODEL**

**PRICE**

**BOX COLUMN FILLERS, 6" WIDE**  
**Tall - Fluted, Beaded Column**  
**15" & 27" Deep**

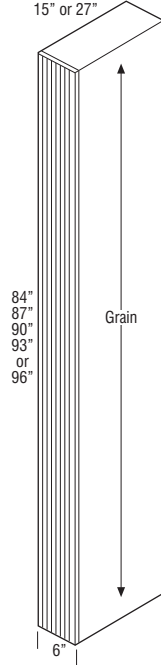

Fluted

<b>T68415BCFF</b> (15" Deep)	1321
<b>T68715BCFF</b> (15" Deep)	1338
<b>T69015BCFF</b> (15" Deep)	1351
<b>T69315BCFF</b> (15" Deep)	1385
<b>T69615BCFF</b> (15" Deep)	1385
<b>T68427BCFF</b> (27" Deep)	1961
<b>T68727BCFF</b> (27" Deep)	1982
<b>T69027BCFF</b> (27" Deep)	2002
<b>T69327BCFF</b> (27" Deep)	2042
<b>T69627BCFF</b> (27" Deep)	2042

<b>T68415BCFB</b> (15" Deep)	1321
<b>T68715BCFB</b> (15" Deep)	1338
<b>T69015BCFB</b> (15" Deep)	1351
<b>T69315BCFB</b> (15" Deep)	1385
<b>T69615BCFB</b> (15" Deep)	1385
<b>T68427BCFB</b> (27" Deep)	1961
<b>T68727BCFB</b> (27" Deep)	1982
<b>T69027BCFB</b> (27" Deep)	2002
<b>T69327BCFB</b> (27" Deep)	2042
<b>T69627BCFB</b> (27" Deep)	2042

- Available in 1" depth increments from 6" to 27".
- Reversible, may be used on either left or right end.
- Front and both sides finished.
- Enclosed top and bottom (not finished).
- 1/2" plywood construction.
- Finished veneer on end panel exterior.
- No reveal on filler.
- T6\_\_BCFF have Fluted fillers. T6\_\_BCFB have Beaded fillers.
- Not intended for use horizontally as shelving. Use Floating Shelves on page 569.

**Custom Modifications**

ID	RD
•*	•

**Finish Techniques**

Distressing	Heirlooming
•	•

\*ID only available on 15" deep.

**Species Availability (Wood)**

Alder	Rustic Alder	Cherry	Rustic Hickory	Maple	Oak
•	Alder	•	Hickory	•	•

**Species Availability (All Laminates)**

High Gloss	Horiz. Grain on Maple	Vert. Grain on Maple	Vert. Grain on Cherry	Vert. Grain on Oak
box color	box color	box color	box color	box color

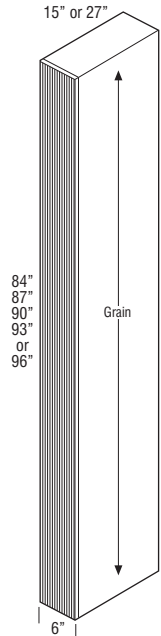

Beaded

**DESCRIPTION MODEL PRICE**  
**PANELS & SKINS**

**END PANEL SKINS, BASE**

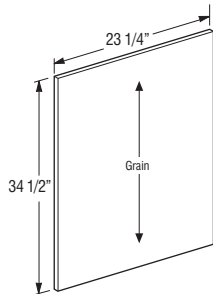

1/4" Finished

**BEPS34.5WD 141**

- Stains: 1/4" thick veneered furniture board.
- Paints: 1/4" thick veneered or solid furniture board.
- 1/4" (WD) skins recommended for use with PFINBTMB modification.

Custom Modifications		Finish Techniques	
ID	RD	Distressing	Heirlooming
•	•		

**Species Availability (Wood)**

Alder	Rustic Alder	Cherry	Rustic Hickory	Maple	Oak
•	Alder	•	Hickory	•	•

**Species Availability (All Laminates)**

High Gloss box color	Horiz. Grain on Maple box color	Vert. Grain on Maple box color	Vert. Grain on Cherry box color	Vert. Grain on Oak box color
•				

**END PANEL SKINS, PREMIUM - BASE**

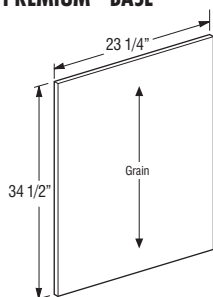

1/4" thick laminated MDF

**BEPS34.5P 283**

- 1/4" thick laminated MDF.
- Not compatible with FPFB.
- High Gloss panels do not have grain.
- 1/4" skins recommended for use with PFINBTMB modification.

Custom Modifications		Finish Techniques	
ID	RD	Distressing	Heirlooming
•	•		

**Species Availability (Wood)**

Alder	Rustic Alder	Cherry	Rustic Hickory	Maple	Oak
•					

**Species Availability (All Laminates)**

High Gloss	Horiz. Grain on Maple	Vert. Grain on Maple	Vert. Grain on Cherry	Vert. Grain on Oak
•				

**DESCRIPTION MODEL PRICE**

**END PANEL SKINS, TALL**



1/4" Finished

**TEPS1248WD 181**



**TEPS1284WD† 262**

**TEPS1296WD† 262**

**TEPS12102WD† ♦ 395**

**TEPS12108WD† ♦ 395**

**TEPS12120WD† ♦ 408**

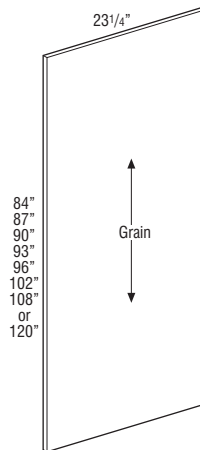
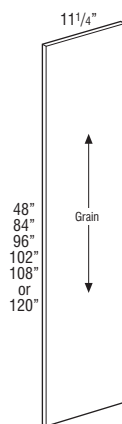

1/4" Finished

**TEPS84WD† 309**

**TEPS87WD† 349**

**TEPS90WD† 387**

**TEPS93WD† 463**

**TEPS96WD† 463**

**TEPS102WD† ♦ 694**

**TEPS108WD† ♦ 694**

**TEPS120WD† ♦ 694**

- Stains: 1/4" thick veneered furniture board.
- Paints: 1/4" thick veneered or solid furniture board.
- 1/4" (WD) skins recommended for use with PFINBTMB modification.

†5 day Express Response not available on items greater than 48".

Custom Modifications		Finish Techniques	
ID	RD	Distressing	Heirlooming
•	•		

**Species Availability (Wood)**

Alder	Rustic Alder	Cherry	Rustic Hickory	Maple	Oak
•	Alder	•	Hickory	•	•

♦ Only available in Cherry and Maple.

**Species Availability (All Laminates)**

High Gloss box color	Horiz. Grain on Maple box color	Vert. Grain on Maple box color	Vert. Grain on Cherry box color	Vert. Grain on Oak box color
•				

♦ Only available in Cherry and Maple box colors.

**519**

**PANELS & SKINS**

**DESCRIPTION MODEL PRICE**

**END PANEL SKINS, PREMIUM - TALL**



TEPS1248P	362
TEPS1296P†	526
TEPS12102P†	788
TEPS12108P†	788
TEPS12120P†	788
TEPS84P†	620
TEPS87P†	699
TEPS90P†	775
TEPS93P†	925
TEPS96P†	925
TEPS102P†	1388
TEPS108P†	1388
TEPS120P†	1388

- 1/4" thick laminated MDF.
  - Not compatible with FPFB.
  - High Gloss panels do not have grain.
- †5 day Express Response not available on items greater than 48"
- 1/4" skins recommended for use with PFINBTMB modification.

Custom Modifications		Finish Techniques	
ID	RD	Distressing	Heirlooming
•	•		

Species Availability (Wood)					
Alder	Rustic Alder	Cherry	Rustic Hickory	Maple	Oak

Species Availability (All Laminates)				
High Gloss	Horiz. Grain on Maple	Vert. Grain on Maple	Vert. Grain on Cherry	Vert. Grain on Oak
•		•*	•*	•*

\*TEPS12102P, TEPS12108P, TEPS12120P, TEPS102P, TEPS108P, and TEPS120P not available in Gunstock.

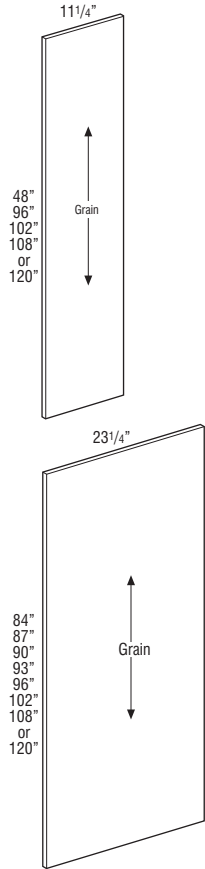

48"  
96"  
102"  
108"  
or  
120"

84"  
87"  
90"  
93"  
96"  
102"  
108"  
or  
120"

**END PANEL SKINS, WALL**



1/4" Finished	
WEPS30WD	87
WEPS33WD	97
WEPS36WD	107
WEPS39WD	118
WEPS42WD	126

- Stains: 1/4" thick veneered furniture board.
- Paints: 1/4" thick veneered or solid furniture board.
- Not compatible with Furniture Ends (FPFB).
- 1/4" (WD) skins recommended for use with PFINBTMB modification.

Custom Modifications		Finish Techniques	
ID	RD	Distressing	Heirlooming
•	•		

Species Availability (Wood)					
Alder	Rustic Alder	Cherry	Rustic Hickory	Maple	Oak
•	Alder	•	Hickory	•	•

Species Availability (All Laminates)				
High Gloss	Horiz. Grain on Maple	Vert. Grain on Maple	Vert. Grain on Cherry	Vert. Grain on Oak
box color	box color	box color	box color	box color

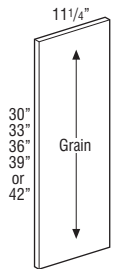

30"  
33"  
36"  
39"  
or  
42"

**DESCRIPTION MODEL PRICE**

**END PANEL SKINS, PREMIUM - WALL**



WEPS30P	174
WEPS33P	195
WEPS36P	213
WEPS39P	237
WEPS42P	251

- 1/4" thick laminated MDF.
- Not compatible with FPFB.
- High Gloss panels do not have grain.
- 1/4" skins recommended for use with PFINBTMB modification.

Custom Modifications		Finish Techniques	
ID	RD	Distressing	Heirlooming
•	•		

Species Availability (Wood)					
Alder	Rustic Alder	Cherry	Rustic Hickory	Maple	Oak

Species Availability (All Laminates)				
High Gloss	Horiz. Grain on Maple	Vert. Grain on Maple	Vert. Grain on Cherry	Vert. Grain on Oak
•		•	•	•

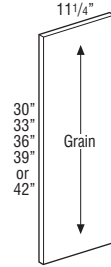

30"  
33"  
36"  
39"  
or  
42"

**FINISHED BACK SKINS**



1/4" Finished	
BP4830WD	214
BP4834.5WD	249
BP4840.5WD	440

1/4" Finished	
BP4896WD†	522

- BP \_\_WD in Stains: 1/4" thick veneered furniture board.
  - BP \_\_WD in Paints: 1/4" thick veneered or solid furniture board.
  - For custom sizes refer to DAPNL 1/4.
- †5 day Express Response not available on items greater than 48"

Custom Modifications		Finish Techniques	
ID	RD	Distressing	Heirlooming

Species Availability (Wood)					
Alder	Rustic Alder	Cherry	Rustic Hickory	Maple	Oak
•	Alder	•	Hickory	•	•

Species Availability (All Laminates)				
High Gloss	Horiz. Grain on Maple	Vert. Grain on Maple	Vert. Grain on Cherry	Vert. Grain on Oak
box color	box color	box color	box color	box color

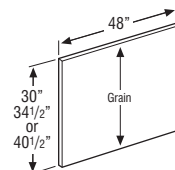

30"  
34 1/2"  
or  
40 1/2"

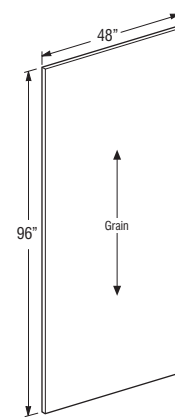

96"

**BACK SKIN, INTERIOR**

1/4" Natural Maple Laminate	
BP4896LAM	234
1/4" Clear Coated Veneer Plywood	
BP4896NIP	429

- BP4896LAM is 1/4" thick furniture board with Natural Maple laminate to match standard cabinet interior.
- BP4896NIP is 1/4" thick plywood with clear coated veneer to match APC cabinet interior.

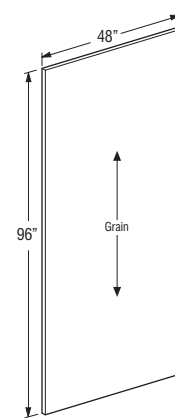

96"

**DESCRIPTION**

**FINISHED BACK SKINS, PREMIUM**

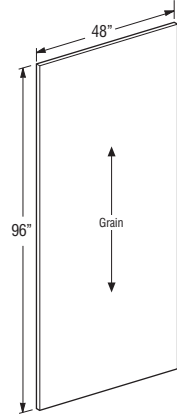
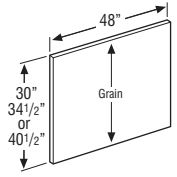

**MODEL**

BP4830P	429
BP4834.5P	498
BP4840.5P	880

BP4896P†	1044
----------	------

- 1/4" thick laminated MDF.
- High Gloss panels do not have grain.
- Not compatible with FPEB.

†5 day Express Response not available on items greater than 48"

**Custom Modifications**

ID	RD

**Finish Techniques**

Distressing	Heirlooming

**Species Availability (Wood)**

Alder	Rustic Alder	Cherry	Rustic Hickory	Maple	Oak

**Species Availability (All Laminates)**

High Gloss	Horiz. Grain on Maple	Vert. Grain on Maple	Vert. Grain on Cherry	Vert. Grain on Oak
•		•	•	•

**CROSS GRAIN VENEER BACK SKIN 1/4" PANELS**

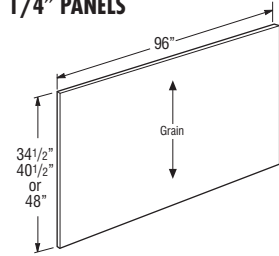

BP9634.5CRSGR	679
BP9640.5CRSGR	679
BP9648CRSGR	679

- BP96\_\_\_\_CRSGR is a 1/4" thick veneered panel with an MDF core.
- When ordered in Paint finishes, panels will use vertical grain as grain will not be visible.

**Custom Modifications**

ID	RD

**Finish Techniques**

Distressing	Heirlooming

**Species Availability (Wood)**

Alder	Rustic Alder	Cherry	Rustic Hickory	Maple	Oak
•	Alder	•	Hickory	•	•

**Species Availability (All Laminates)**

High Gloss	Horiz. Grain on Maple	Vert. Grain on Maple	Vert. Grain on Cherry	Vert. Grain on Oak
box color	box color	box color	box color	box color

**DESCRIPTION**

**WOOD V-GROOVED BEADED SKIN 1/4" PANELS**

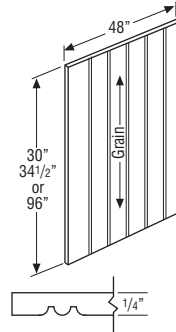

**MODEL**

BP4830VG	531
BP4834.5VG	571
BP4896VG†	1291

- BP48\_\_VG is a 1/4" thick veneered panel with an MDF core.
  - V-groove on 3" centers.
  - When used as a skin, not compatible in conjunction with Furniture Ends (FPEB) or Authentic Ends (AUTHL/AUTHR).
- †5 day Express Response not available on items greater than 48"

**Custom Modifications**

ID	RD

**Finish Techniques**

Distressing	Heirlooming
	•

**Species Availability (Wood)**

Alder	Rustic Alder	Cherry	Rustic Hickory	Maple	Oak
•	Alder	•	Hickory	•	•

**Species Availability (All Laminates)**

High Gloss	Horiz. Grain on Maple	Vert. Grain on Maple	Vert. Grain on Cherry	Vert. Grain on Oak
box color	box color	box color	box color	box color

**HORIZONTAL GRAIN 1/4" SKIN, PREMIUM**

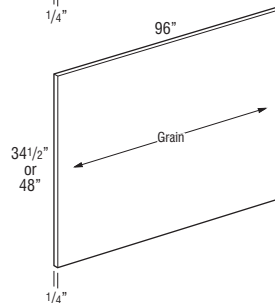
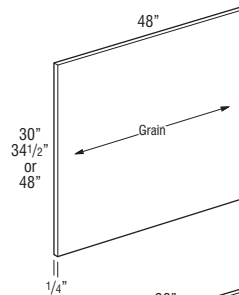
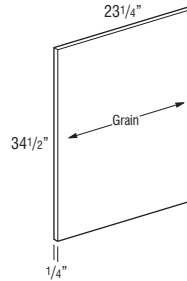
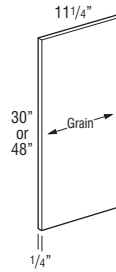

14PANEL11.2530P	174
14PANEL11.2548P	362

14PANEL2334.5P	282
----------------	-----

14PANEL4830P	428
--------------	-----

14PANEL4834.5P	498
----------------	-----

14PANEL4848P	548
--------------	-----

14PANEL9634.5P†	925
-----------------	-----

14PANEL9648P†	1044
---------------	------

- 1/4" thick laminated MDF.
  - Not compatible with FPEB.
- †5 day Express Response not available on items greater than 48"

**Custom Modifications**

ID	RD

**Finish Techniques**

Distressing	Heirlooming

**Species Availability (Wood)**

Alder	Rustic Alder	Cherry	Rustic Hickory	Maple	Oak

**Species Availability (All Laminates)**

High Gloss	Horiz. Grain on Maple	Vert. Grain on Maple	Vert. Grain on Cherry	Vert. Grain on Oak
	•			

**DESCRIPTION MODEL PRICE**

**HORIZONTAL GRAIN 3/4" PANEL, PREMIUM**



<b>34PANEL1230P</b>	286
<b>34PANEL1248P</b>	514
<b>34PANEL2434.5P</b>	462
<b>34PANEL4812P</b>	515
<b>34PANEL4834.5P</b>	576
<b>34PANEL4848P</b>	633
<b>34PANEL9612P†</b>	720
<b>34PANEL9624P†</b>	1412
<b>34PANEL9630P†</b>	1765

- 3/4" thick laminated MDF.
- Not compatible with FPEB.
- 34PANEL4812P and 34PANEL9612P recommended for exterior shelf material.
- Edgebanded on one short side and one long side only. Other edges will require moulding if exposed.

†5 day Express Response not available on items greater than 48"

Custom Modifications				Finish Techniques	
ID	RD	APC	MIP	Distressing	Heirlooming
•	•				

Species Availability (Wood)					
Alder	Rustic Alder	Cherry	Rustic Hickory	Maple	Oak
•	•				

Species Availability (All Laminates)				
High Gloss	Horiz. Grain on Maple	Vert. Grain on Maple	Vert. Grain on Cherry	Vert. Grain on Oak
•				

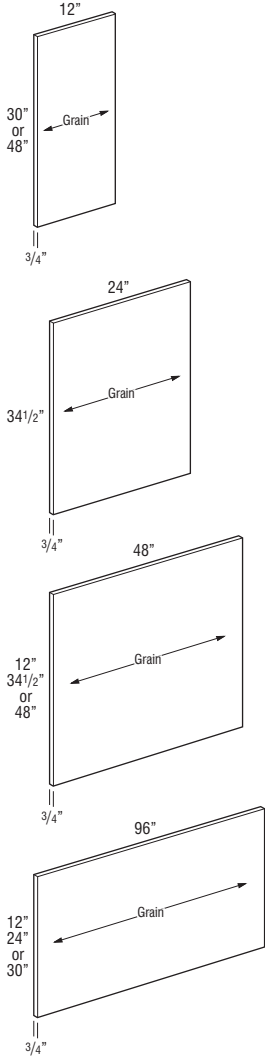

**END PANELS, WALL**



<b>3/4" Finished WEP1230WD</b>	143
<b>3/4" White Laminate WEP1230LAM ♦</b>	97

- WEP1230WD in Stains: 3/4" thick veneered furniture board.
- WEP1230WD in Paints: 3/4" thick veneered or solid furniture board.
- WEP1230LAM is 3/4" thick laminated furniture board (white only).
- Panels are finished on two sides and front edge.

Custom Modifications				Finish Techniques	
ID	RD	APC	MIP	Distressing	Heirlooming
•	•				
•	•				

Species Availability (Wood)					
Alder	Rustic Alder	Cherry	Rustic Hickory	Maple	Oak
•	•				
•	•				

♦ Only available in White laminate.

Species Availability (All Laminates)				
High Gloss	Horiz. Grain on Maple	Vert. Grain on Maple	Vert. Grain on Cherry	Vert. Grain on Oak
•				
•				

♦ Only available in White laminate.

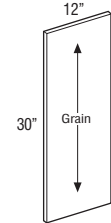

**DESCRIPTION MODEL PRICE**

**END PANELS, PREMIUM - WALL**



<b>WEP1230P</b>	287
-----------------	-----

- 3/4" thick laminated MDF.
- High Gloss panels will have high gloss on front of panel and back of panel will be white melamine.
- High Gloss panels do not have grain.
- Front of panel and edgebanding on front, top, and bottom of panel will match doors.

Custom Modifications				Finish Techniques	
ID	RD	APC	MIP	Distressing	Heirlooming
•	•				

Species Availability (Wood)					
Alder	Rustic Alder	Cherry	Rustic Hickory	Maple	Oak
•	•				

Species Availability (All Laminates)				
High Gloss	Horiz. Grain on Maple	Vert. Grain on Maple	Vert. Grain on Cherry	Vert. Grain on Oak
•				

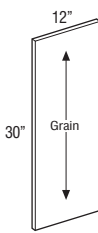

**END PANELS, BASE**



<b>3/4" Finished BEPWD</b>	231
<b>3/4" White Laminate BEPLAM ♦</b>	156

- BEPWD in Stains: 3/4" thick veneered furniture board.
- BEPWD in Paints: 3/4" thick veneered or solid furniture board.
- BEPLAM is 3/4" thick laminated furniture board (white only).
- Panels are finished on two sides and front edge.

Custom Modifications				Finish Techniques	
ID	RD	APC	MIP	Distressing	Heirlooming
•	•				
•	•				

Species Availability (Wood)					
Alder	Rustic Alder	Cherry	Rustic Hickory	Maple	Oak
•	•				
•	•				

♦ Only available in White laminate.

Species Availability (All Laminates)				
High Gloss	Horiz. Grain on Maple	Vert. Grain on Maple	Vert. Grain on Cherry	Vert. Grain on Oak
•				
•				

♦ Only available in White laminate.

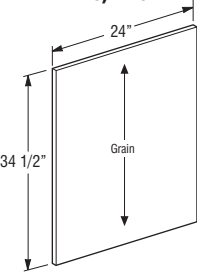

**END PANELS, PREMIUM - BASE**



<b>BEPP</b>	460
-------------	-----

- 3/4" thick laminated MDF.
- High Gloss panels will have high gloss on front of panel and back of panel will be white melamine. Edgebanding on front edge will match door and drawer front edgebanding selection.
- High Gloss panels do not have grain.

Custom Modifications				Finish Techniques	
ID	RD	APC	MIP	Distressing	Heirlooming
•	•				

Species Availability (Wood)					
Alder	Rustic Alder	Cherry	Rustic Hickory	Maple	Oak
•	•				

Species Availability (All Laminates)				
High Gloss	Horiz. Grain on Maple	Vert. Grain on Maple	Vert. Grain on Cherry	Vert. Grain on Oak
•				

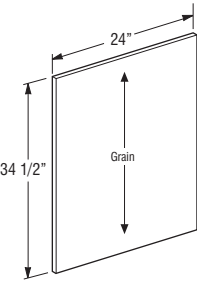

**DESCRIPTION**

**MODEL**

**PRICE**

**END PANELS, LAZY SUSAN**

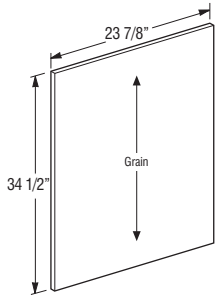

1/2" Finished

**BLSBEPWD** 231

1/2" White Laminate

**BLSBEPLAM** ♦ 156

- BLSBEPWD panels have veneer finished exterior and Natural Maple laminate interior. Specify MIP for veneered interior or APC for clear coated veneer.
- BLSBEPLAM panels have White laminated exterior and Natural Maple laminated interior.

**Custom Modifications**

	ID	RD	APC	MIP
Laminate	•	•	•	•
Wood	•	•	•	•

**Finish Techniques**

Distressing	Heirlooming

**Species Availability (Wood)**

Rustic Alder	Cherry	Rustic Hickory	Maple	Oak
• Alder	•	• Hickory	•	•

♦ Only available in White laminate.

**Species Availability (All Laminates)**

High Gloss box color	Horiz. Grain on Maple box color	Vert. Grain on Maple box color	Vert. Grain on Cherry box color	Vert. Grain on Oak box color

♦ Only available in White laminate.

**DESCRIPTION**

**MODEL**

**PRICE**

**END PANELS, TALL**

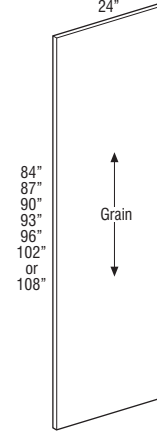
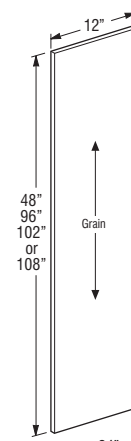

3/4" Finished

**TEP1248WD** 257

**TEP1296WD**† 360

**TEP12102WD**† ♦♦ 540

**TEP12108WD**† ♦♦ 558

3/4" White Laminate

**TEP1248LAM** ♦ 141

**TEP1296LAM**† ♦ 203

3/4" Finished

**TEP2484WD**†▲ 504

**TEP2487WD**†▲ 556

**TEP2490WD**†▲ 609

**TEP2493WD**†▲ 706

**TEP2496WD**†▲ 706

**TEP24102WD**† ♦♦ 1058

**TEP24108WD**† ♦♦ 1092

3/4" White Laminate

**TEP2484LAM**† ♦ 276

**TEP2487LAM**† ♦ 306

**TEP2490LAM**† ♦ 338

**TEP2493LAM**† ♦ 396

**TEP2496LAM**† ♦ 396

- TEP\_ \_WD in Stains: 3/4" thick veneered furniture board.
  - TEP\_ \_WD in Paints: 3/4" thick veneered or solid furniture board.
  - TEP\_ \_LAM is 3/4" thick laminated furniture board (white only).
  - Panels are finished on two sides and front edge.
  - 102" and 108" will have APC and MIP standard.
- †5 day Express Response not available on items greater than 48".

**Custom Modifications**

	ID	RD	APC	MIP
Laminate	•	•	•	•
Wood	•▲	•	•	•

**Finish Techniques**

Distressing	Heirlooming

▲Tall wood panels will be plywood when ID31-ID36 is specified.

**Species Availability (Wood)**

Rustic Alder	Cherry	Rustic Hickory	Maple	Oak
• Alder	•	• Hickory	•	•

♦ Only available in White laminate.

♦♦ Only available in Cherry and Maple.

**Species Availability (All Laminates)**

High Gloss box color	Horiz. Grain on Maple box color	Vert. Grain on Maple box color	Vert. Grain on Cherry box color	Vert. Grain on Oak box color

♦ Only available in White laminate.

♦♦ Only available in Cherry and Maple box colors.

DESCRIPTION

MODEL

PRICE

END PANELS, PREMIUM - TALL



TEP1248P	515
TEP1296P†	720
TEP12102P†	1080
TEP12108P†	1080
TEP2484P†	1009
TEP2487P†	1114
TEP2490P†	1216
TEP2493P†	1411
TEP2496P†	1411
TEP24102P†	2117
TEP24108P†	2117

- 3/4" thick laminated MDF.
  - High Gloss panels will have high gloss on front of panel and back of panel will be white melamine. Edgebanding on front edge will match door and drawer front edgebanding selection.
  - High Gloss panels do not have grain.
- †5 day Express Response not available on items greater than 48"

Custom Modifications

ID	RD	APC	MIP
•*	•		

Finish Techniques

Distressing	Heirlooming

\*ID available on TEP2484P-TEP2496P up to 30". ID not available on TEP24102P and TEP24108P.

Species Availability (Wood)

Alder	Rustic Alder	Cherry	Rustic Hickory	Maple	Oak

Species Availability (All Laminates)

High Gloss	Horiz. Grain on Maple	Vert. Grain on Maple	Vert. Grain on Cherry	Vert. Grain on Oak
•		•*	•*	•*

\*TEP12102P, TEP12108P, TEP24102P, and TEP24108P not available in Gunstock.

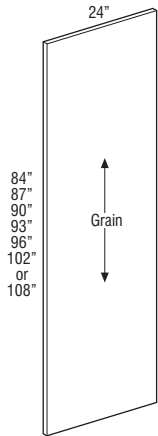
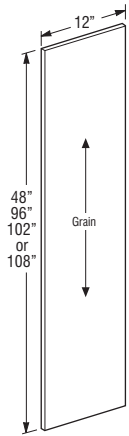

END PANELS, VANITY

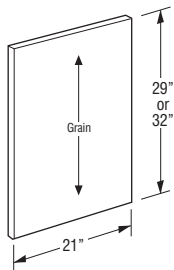

3/4" Finished

VBEP2129WD	231
VBEP2132WD	231

3/4" White Laminate

VBEP2129LAM ♦	156
VBEP2132LAM ♦	156

- VBEP\_ \_WD in Stains: 3/4" thick veneered furniture board.
- VBEP\_ \_WD in Paints: 3/4" thick veneered or solid furniture board.
- VBEP\_ \_LAM is 3/4" thick laminated furniture board (white only).
- Panels are finished on two sides and front edge.

Custom Modifications

ID	RD	APC	MIP
•	•		
•	•	•	

Finish Techniques

Distressing	Heirlooming

Species Availability (Wood)

Alder	Rustic Alder	Cherry	Rustic Hickory	Maple	Oak
•	•	•	•	•	•

♦ Only available in White laminate.

Species Availability (All Laminates)

High Gloss	Horiz. Grain on Maple	Vert. Grain on Maple	Vert. Grain on Cherry	Vert. Grain on Oak
box color	box color	box color	box color	box color

♦ Only available in White laminate.

DESCRIPTION

MODEL

PRICE

WALL PANEL with FILLER ATTACHED



1/2" Finished	
WEP1230F1.5WD	265
WEP1230F3WD	297
WEP1233F1.5WD	281
WEP1233F3WD	311
WEP1236F1.5WD	294
WEP1236F3WD	328
WEP1239F1.5WD	323
WEP1239F3WD	359
WEP1242F1.5WD	353
WEP1242F3WD	398
1/2" White Laminate	
WEP1230F1.5LAM ♦	212
WEP1230F3LAM ♦	237
WEP1233F1.5LAM ♦	224
WEP1233F3LAM ♦	250
WEP1236F1.5LAM ♦	235
WEP1236F3LAM ♦	261
WEP1239F1.5LAM ♦	257
WEP1239F3LAM ♦	289
WEP1242F1.5LAM ♦	285
WEP1242F3LAM ♦	317

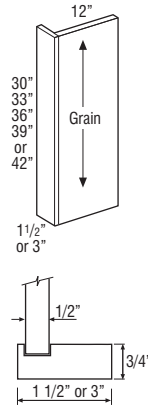

- WEP\_ \_F\_ \_WD in Stains: 1/2" thick veneered furniture board.
- WEP\_ \_F\_ \_WD in Paints: 1/2" thick veneered or solid furniture board.
- WD panels have Natural Maple laminate interior. **Specify MIP for veneered interior or APC for clear coated veneer.**
- WEP\_ \_F\_ \_LAM is 1/2" thick laminated furniture board (White exterior with Natural Maple interior).

Custom Modifications

ID	RD	APC	MIP	WLI
•	•			•
•	•	•	•	•

Finish Techniques

Distressing	Heirlooming
•*	

\*Distressing on filler only, not on panel. Not available on laminate panels.

Species Availability (Wood)

Alder	Rustic Alder	Cherry	Rustic Hickory	Maple	Oak
•	•	•	•	•	•

♦ Only available in White laminate.

Species Availability (All Laminates)

High Gloss	Horiz. Grain on Maple	Vert. Grain on Maple	Vert. Grain on Cherry	Vert. Grain on Oak
box color	box color	box color	box color	box color

♦ Only available in White laminate.



**DESCRIPTION**

**BASE and TALL PANELS with FILLER ATTACHED**

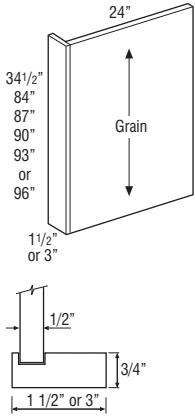

**MODEL**

**PRICE**

1/2" Finished	
<b>BEPF1.5WD</b>	290
<b>BEPF3WD</b>	317
1/2" White Laminate	
<b>BEPF1.5LAM ♦</b>	226
<b>BEPF3LAM ♦</b>	253
1/2" Finished	
<b>TEP2484F1.5WD†</b>	594
<b>TEP2484F3WD†</b>	660
<b>TEP2487F1.5WD†</b>	655
<b>TEP2487F3WD†</b>	727
<b>TEP2490F1.5WD†</b>	712
<b>TEP2490F3WD†</b>	793
<b>TEP2493F1.5WD†</b>	832
<b>TEP2493F3WD†</b>	924
<b>TEP2496F1.5WD†</b>	832
<b>TEP2496F3WD†</b>	924
1/2" White Laminate	
<b>TEP2484F1.5LAM† ♦</b>	384
<b>TEP2484F3LAM† ♦</b>	426
<b>TEP2487F1.5LAM† ♦</b>	425
<b>TEP2487F3LAM† ♦</b>	472
<b>TEP2490F1.5LAM† ♦</b>	465
<b>TEP2490F3LAM† ♦</b>	518
<b>TEP2493F1.5LAM† ♦</b>	548
<b>TEP2493F3LAM† ♦</b>	612
<b>TEP2496F1.5LAM† ♦</b>	548
<b>TEP2496F3LAM† ♦</b>	612

- BEPF\_WD and TEP\_\_F\_WD in Stains: 1/2" thick veneered furniture board.
- BEPF\_WD and TEP\_\_F\_WD in Paints: 1/2" thick veneered or solid furniture board.
- WD panels have Natural Maple laminate interior. **Specify MIP for veneered interior or APC for clear coated veneer.**
- BEPF\_LAM and TEP\_\_F\_LAM is 1/2" thick laminated furniture board (White exterior with Natural Maple interior).

†5 day Express Response not available on items greater than 48".

**Custom Modifications**

	ID	RD	APC	MIP	WLI
Laminate	•	•			•
Wood	•	•	•	•	•

**Finish Techniques**

Distressing	Heirlooming
•*	

\*Distressing on filler only, not on panel. Not available on laminate panels.

**Species Availability (Wood)**

Alder	Rustic Alder	Cherry	Rustic Hickory	Maple	Oak
•	•	•	•	•	•

♦ Only available in White laminate.

**Species Availability (All Laminates)**

High Gloss	Horiz. Grain on Maple	Vert. Grain on Maple	Vert. Grain on Cherry	Vert. Grain on Oak
box color	box color	box color	box color	box color

♦ Only available in White laminate.

**DESCRIPTION**

**WALL PANEL with FILLER ATTACHED and FURNITURE ENDS**

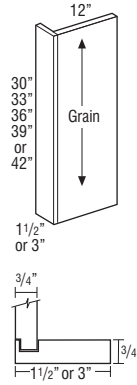

**MODEL**

**PRICE**

<b>WEP1230F1.5FPE</b>	300
<b>WEP1230F3FPE</b>	337
<b>WEP1233F1.5FPE</b>	315
<b>WEP1233F3FPE</b>	353
<b>WEP1236F1.5FPE</b>	331
<b>WEP1236F3FPE</b>	371
<b>WEP1239F1.5FPE</b>	362
<b>WEP1239F3FPE</b>	406
<b>WEP1242F1.5FPE</b>	401
<b>WEP1242F3FPE</b>	448

- 3/4" thick veneered plywood.
- Panel will have veneered exterior and Natural Maple laminated interior.
- Specify MIP for veneered interior or APC for clear coated veneer.

**Custom Modifications**

	ID	RD	APC	MIP
Wood	•	•	•	•

**Finish Techniques**

Distressing	Heirlooming
•	

**Species Availability (Wood)**

Alder	Rustic Alder	Cherry	Rustic Hickory	Maple	Oak
•	•	•	•	•	•

**Species Availability (All Laminates)**

High Gloss	Horiz. Grain on Maple	Vert. Grain on Maple	Vert. Grain on Cherry	Vert. Grain on Oak
box color	box color	box color	box color	box color

DESCRIPTION

MODEL

PRICE

BASE and TALL PANELS with FILLER ATTACHED and FURNITURE ENDS

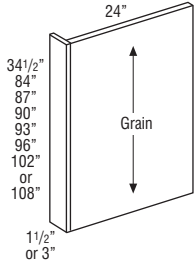

BEPF1.5FPE	333
BEPF3FPE	364
TEP2484F1.5FPE†	684
TEP2484F3FPE†	758
TEP2487F1.5FPE†	789
TEP2487F3FPE†	835
TEP2490F1.5FPE†	820
TEP2490F3FPE†	913
TEP2493F1.5FPE†	959
TEP2493F3FPE†	1062
TEP2496F1.5FPE†	959
TEP2496F3FPE†	1062
TEP24102F1.5FPE† ♦	1438
TEP24102F3FPE† ♦	1594
TEP24108F1.5FPE† ♦	1438
TEP24108F3FPE† ♦	1594

- 3/4" thick veneered plywood.
  - Panel will have veneered exterior and Natural Maple laminated interior.
  - Specify MIP for veneered interior or APC for clear coated veneer.
  - 102" and 108" are MIP standard.
- †5 day Express Response not available on items greater than 48".

Custom Modifications				Finish Techniques	
ID	RD	APC	MIP	Distressing	Heirlooming
Wood	•	•	•	•	

Species Availability (Wood)

Alder	Rustic Alder	Cherry	Rustic Hickory	Maple	Oak
•	•	•	•	•	•

♦ Only available in Cherry and Maple.

Species Availability (All Laminates)

High Gloss	Horiz. Grain on Maple	Vert. Grain on Maple	Vert. Grain on Cherry	Vert. Grain on Oak
box color	box color	box color	box color	box color

♦ Only available in Cherry and Maple box colors.

DESCRIPTION

MODEL

PRICE

WALL PANEL with FILLER ATTACHED and AUTHENTIC ENDS

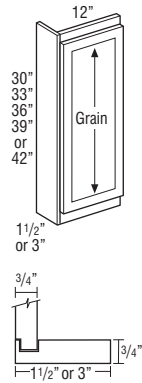

WEP1230F1.5AEL	440
WEP1230F1.5AER	440
WEP1230F3AEL	490
WEP1230F3AER	490
WEP1233F1.5AEL	461
WEP1233F1.5AER	461
WEP1233F3AEL	515
WEP1233F3AER	515
WEP1236F1.5AEL	484
WEP1236F1.5AER	484
WEP1236F3AEL	539
WEP1236F3AER	539
WEP1239F1.5AEL	531
WEP1239F1.5AER	531
WEP1239F3AEL	593
WEP1239F3AER	593
WEP1242F1.5AEL	583
WEP1242F1.5AER	583
WEP1242F3AEL	655
WEP1242F3AER	655

- 3/4" thick veneered plywood with doors attached.
- Depth can be increased in 3" increments up to 24" deep.
- Panel will have veneered exterior and Natural Maple laminated interior standard. For veneered interior, specify MIP.
- Aspen doors will be high gloss and match edgebanding selection.
- Derazi doors will have horizontal grain with matching edgebanding.
- Gallio doors will have vertical grain with matching edgebanding.

Custom Modifications					Finish Techniques	
ID	RD	APC	MFO	MIP	Distressing	Heirlooming
Wood	•	•	•	•	•	•

Species Availability (Wood)

Alder	Rustic Alder	Cherry	Rustic Hickory	Maple	Oak
•	•	•	•	•	•

Species Availability (All Laminates)

High Gloss	Horiz. Grain on Maple	Vert. Grain on Maple	Vert. Grain on Cherry	Vert. Grain on Oak
box color	box color	box color	box color	box color

**DESCRIPTION**

**MODEL**

**PRICE**

**BASE PANEL with FILLER ATTACHED and AUTHENTIC ENDS**



<b>BEPF1.5AEL</b>	881
<b>BEPF1.5AER</b>	881
<b>BEPF3AEL</b>	912
<b>BEPF3AER</b>	912

- 3/4" thick veneered plywood with doors attached.
- Depth can be increased in 3" increments up to 36" deep.
- Panel will have veneered exterior and Natural Maple laminated interior standard. For veneered interior, specify MIP.
- Aspen doors will be high gloss and match edgebanding selection.
- Derazi doors will have horizontal grain with matching edgebanding.
- Gallio doors will have vertical grain with matching edgebanding.

**Custom Modifications**

ID	RD	APC	MFO	MIP
Wood	•			•

**Finish Techniques**

Distressing	Heirlooming
•	•

**Species Availability (Wood)**

Alder	Rustic Alder	Cherry	Rustic Hickory	Maple	Oak
•	•	•	•	•	•

**Species Availability (All Laminates)**

High Gloss box color	Horiz. Grain on Maple box color	Vert. Grain on Maple box color	Vert. Grain on Cherry box color	Vert. Grain on Oak box color

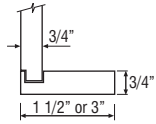
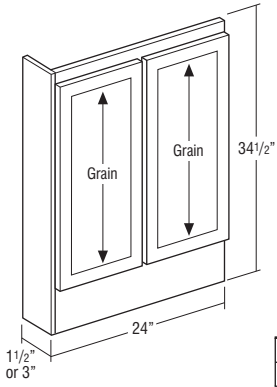

**BASE PANEL with FILLER ATTACHED and AUTHENTIC ENDS, SINGLE DOOR**



<b>BEPF1.5AELSD</b>	881
<b>BEPF1.5AERSD</b>	881
<b>BEPF3AELSD</b>	912
<b>BEPF3AERSD</b>	912

- 3/4" thick veneered plywood with doors attached.
- Depth can be reduced in 3" increments down to 9" deep.
- Panel will have veneered exterior and Natural Maple laminated interior standard. For veneered interior, specify MIP.
- Aspen doors will be high gloss and match edgebanding selection.
- Derazi doors will have horizontal grain with matching edgebanding.
- Gallio doors will have vertical grain with matching edgebanding.

**Custom Modifications**

ID	RD	APC	MFO	MIP
Wood	•			•

**Finish Techniques**

Distressing	Heirlooming
•	•

**Species Availability (Wood)**

Alder	Rustic Alder	Cherry	Rustic Hickory	Maple	Oak
•	•	•	•	•	•

**Species Availability (All Laminates)**

High Gloss box color	Horiz. Grain on Maple box color	Vert. Grain on Maple box color	Vert. Grain on Cherry box color	Vert. Grain on Oak box color

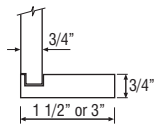
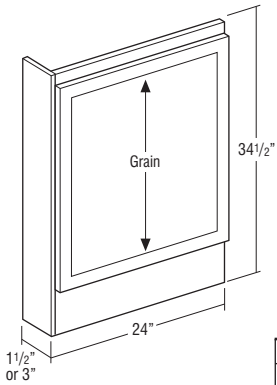

**DESCRIPTION**

**MODEL**

**PRICE**

**TALL PANEL with FILLER ATTACHED and AUTHENTIC ENDS**

<b>TEP2484F1.5AEL</b>	2010
<b>TEP2484F1.5AER</b>	2010
<b>TEP2484F3AEL</b>	2078
<b>TEP2484F3AER</b>	2078
<b>TEP2487F1.5AEL</b>	2071
<b>TEP2487F1.5AER</b>	2071
<b>TEP2487F3AEL</b>	2144
<b>TEP2487F3AER</b>	2144
<b>TEP2490F1.5AHAL</b>	2131
<b>TEP2490F1.5AHAR</b>	2131
<b>TEP2490F3AHAL</b>	2210
<b>TEP2490F3AHAR</b>	2210
<b>TEP2493F1.5AHAL</b>	2250
<b>TEP2493F1.5AHAR</b>	2250
<b>TEP2493F3AHAL</b>	2343
<b>TEP2493F3AHAR</b>	2343
<b>TEP2496F1.5AEL</b>	2250
<b>TEP2496F1.5AER</b>	2250
<b>TEP2496F3AEL</b>	2343
<b>TEP2496F3AER</b>	2343

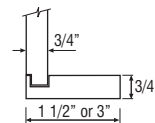
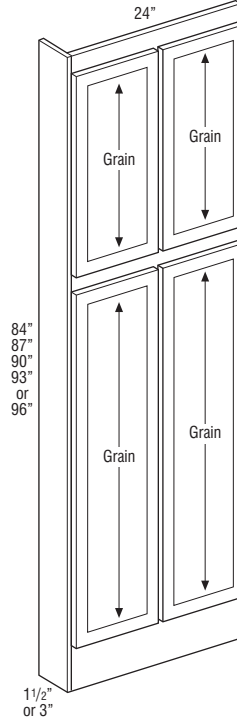

- AH represents upper section alignment with doors on 24" or 27" high cabinets.
- 3/4" thick veneered plywood with doors attached.
- Depth can be increased in 3" increments up to 36" deep.
- Panel will have veneered exterior and Natural Maple laminated interior standard. For veneered interior, specify MIP.
- Aspen doors will be high gloss and match edgebanding selection.
- Derazi doors will have horizontal grain with matching edgebanding.
- Gallio doors will have vertical grain with matching edgebanding.

**Custom Modifications**

ID	RD	APC	MFO	MIP	INFRM
Wood	•		•	•	•

**Finish Techniques**

Distressing	Heirlooming
•	•

**Species Availability (Wood)**

Alder	Rustic Alder	Cherry	Rustic Hickory	Maple	Oak
•	•	•	•	•	•

**Species Availability (All Laminates)**

High Gloss box color	Horiz. Grain on Maple box color	Vert. Grain on Maple box color	Vert. Grain on Cherry box color	Vert. Grain on Oak box color

DESCRIPTION	MODEL	PRICE
<b>TALL PANEL with FILLER ATTACHED and AUTHENTIC ENDS, SINGLE DOOR</b>	TEP84F1.5AELSD	2010
	TEP84F1.5AERSD	2010
	TEP84F3AELSD	2078
	TEP84F3AERSD	2078
	TEP87F1.5AELSD	2071
	TEP87F1.5AERSD	2071
	TEP87F3AELSD	2144
	TEP87F3AERSD	2144
	TEP90F1.5AHALSD	2131
	TEP90F1.5AHARSD	2131
	TEP90F3AHALSD	2210
	TEP90F3AHARSD	2210
	TEP93F1.5AHALSD	2250
	TEP93F1.5AHARSD	2250
	TEP93F3AHALSD	2343
	TEP93F3AHARSD	2343
	TEP96F1.5AELSD	2250
	TEP96F1.5AERSD	2250
TEP96F3AELSD	2343	
TEP96F3AERSD	2343	

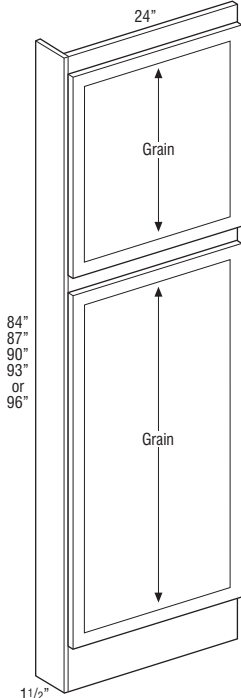

- AH represents upper section alignment with doors on 24" or 27" high cabinets.
- 3/4" thick veneered plywood with doors attached.
- Depth can be reduced in 3" increments down to 9" deep.
- On non-miter doors, the tall door on the bottom will have two vertical panels.
- Panel will have veneered exterior and Natural Maple laminated interior standard. For veneered interior, specify MIP.
- Aspen doors will be high gloss and match edgebanding selection.
- Derazi doors will have horizontal grain with matching edgebanding.
- Gallio doors will have vertical grain with matching edgebanding.

Custom Modifications							Finish Techniques	
ID	RD	APC	MFO	MIP	INVERM	Distressing	Heirlooming	
Wood	•		•	•	•	•	•	

Species Availability (Wood)					
Alder	Rustic Alder	Cherry	Rustic Hickory	Maple	Oak
•	•	•	•	•	•

Species Availability (All Laminates)				
High Gloss box color	Horiz. Grain on Maple box color	Vert. Grain on Maple box color	Vert. Grain on Cherry box color	Vert. Grain on Oak box color

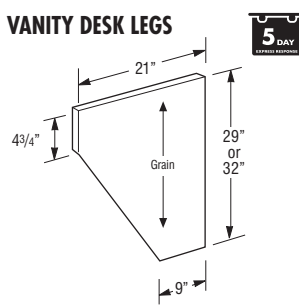

DESCRIPTION	MODEL	PRICE
<b>VANITY DESK LEGS</b>	VDL2129WD	223
	VDL2132WD	223

- All panels are finished 2 sides and front edge.
- VDL\_\_WD in Stains: 3/4" thick veneered furniture board.
- VDL\_\_WD in Paints: 3/4" thick veneered or solid furniture board.

Custom Modifications		Finish Techniques	
ID	RD	Distressing	Heirlooming

Species Availability (Wood)					
Alder	Rustic Alder	Cherry	Rustic Hickory	Maple	Oak
•	•	•	•	•	•

Species Availability (All Laminates)				
High Gloss box color	Horiz. Grain on Maple box color	Vert. Grain on Maple box color	Vert. Grain on Cherry box color	Vert. Grain on Oak box color

DESCRIPTION	MODEL	PRICE
<b>WOOD V-GROOVED with TRIPLE BEADED FRONT 3/4" PANELS</b>	BEPVG (34 1/2")	24 3/4" 454
	BEPPVG (Peninsula)	25 1/2" 593
	TEP1284VG†	12 3/4" 404
	TEP1296VG†	12 3/4" 577
	TEP84VG†	24 3/4" 984
	TEP87VG†	24 3/4" 1018
	TEP90VG†	24 3/4" 1050
	TEP93VG†	24 3/4" 1116
	TEP96VG†	24 3/4" 1116
	VBEP29VG	21 3/4" 454
	VBEP32VG	21 3/4" 454
	WEP12VG	12 3/4" 237
	WEP15VG	12 3/4" 242
	WEP18VG	12 3/4" 250
	WEP21VG	12 3/4" 258
	WEP24VG	12 3/4" 261
	WEP27VG	12 3/4" 269
	WEP30VG	12 3/4" 285
WEP33VG	12 3/4" 321	
WEP36VG	12 3/4" 353	
WEP39VG	12 3/4" 375	
WEP42VG	12 3/4" 375	
WEPP42VG (Peninsula)	13 1/2" 415	

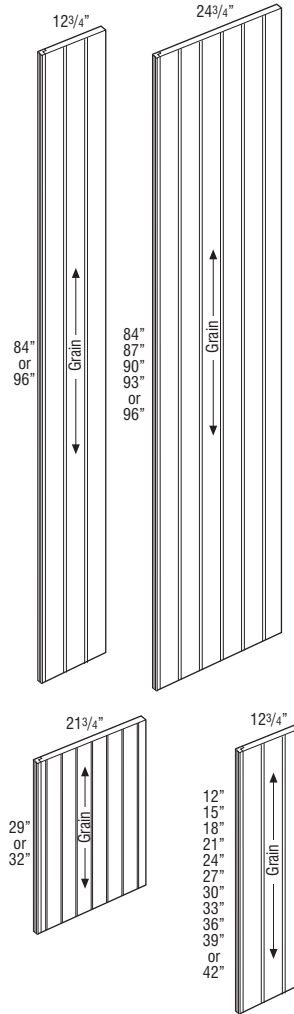

- Veneer on MDF core.
  - V-groove on 3" centers.
- †5 day Express Response not available on items greater than 48".

Custom Modifications		Finish Techniques	
ID	RD	Distressing	Heirlooming
			•

Species Availability (Wood)					
Alder	Rustic Alder	Cherry	Rustic Hickory	Maple	Oak
				•	

Species Availability (All Laminates)				
High Gloss box color	Horiz. Grain on Maple box color	Vert. Grain on Maple box color	Vert. Grain on Cherry box color	Vert. Grain on Oak box color

**DESCRIPTION**

**MODEL**

**PRICE**

**DECORATIVE DOOR  
PANEL KITS  
Base End**



**BED**

**612**

**BEDSD**

**612**

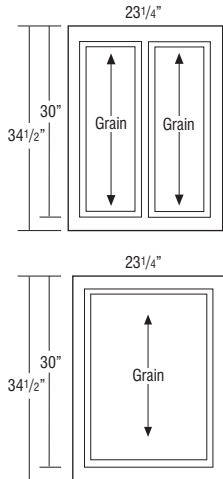

- Door panel kits include Base End Panel Skin and doors with attachment screws for field installation.
- Not compatible on cabinets specified with FPFB. Use Authentic Ends modification for decorative doors with FPFB.
- Aspen doors will be high gloss and match edgebanding selection.
- Derazi doors will have horizontal grain with matching edgebanding.
- Gallio doors will have vertical grain with matching edgebanding.

**Custom Modifications**

ID	RD	MFO

**Finish Techniques**

Distressing	Heirlooming
•	•

**Species Availability (Wood)**

Alder	Rustic Alder	Cherry	Rustic Hickory	Maple	Oak
•	•	•	•	•	•

**Species Availability (All Laminates)**

High Gloss	Horiz. Grain on Maple	Vert. Grain on Maple	Vert. Grain on Cherry	Vert. Grain on Oak
box color	box color	box color	box color	box color

**DESCRIPTION**

**MODEL**

**PRICE**

**DECORATIVE DOOR  
PANEL KITS  
Tall End**

**TED2484**

**1408**

**TED2487**

**1436**

**TED2490AH**

**1459**

**TED2493AH**

**1506**

**TED2496**

**1506**

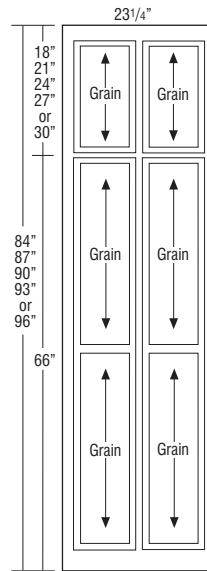

**TED2484SD**

**1408**

**TED2487SD**

**1436**

**TED2490SDAH**

**1459**

**TED2493SDAH**

**1506**

**TED2496SD**

**1506**

- AH represents upper section alignment with doors on 24" or 27" high cabinets.
- Door panel kits include Tall End Panel Skin and doors with attachment screws for field installation.
- Not compatible on cabinets specified with FPFB. Use Authentic Ends modification for decorative doors with FPFB.
- On non-miter doors, the tall door on the bottom will have two vertical panels.
- Aspen doors will be high gloss and match edgebanding selection.
- Derazi doors will have horizontal grain with matching edgebanding.
- Gallio doors will have vertical grain with matching edgebanding.

**Custom Modifications**

ID	RD	MFO

**Finish Techniques**

Distressing	Heirlooming
•	•

**Species Availability (Wood)**

Alder	Rustic Alder	Cherry	Rustic Hickory	Maple	Oak
•	•	•	•	•	•

**Species Availability (All Laminates)**

High Gloss	Horiz. Grain on Maple	Vert. Grain on Maple	Vert. Grain on Cherry	Vert. Grain on Oak
box color	box color	box color	box color	box color

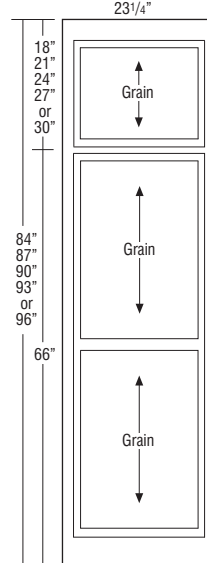





**WAINSCOTING, 34 1/2" or 40 1/2" HIGH**

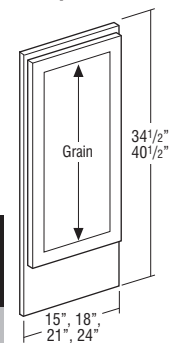

WAIN1534.5 WAIN1540.5  
WAIN1834.5 WAIN1840.5  
WAIN2134.5 WAIN2140.5  
WAIN2434.5 WAIN2440.5

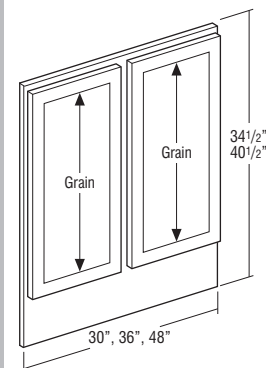

WAIN3034.5 WAIN3040.5  
WAIN3634.5 WAIN3640.5  
WAIN4834.5 WAIN4840.5

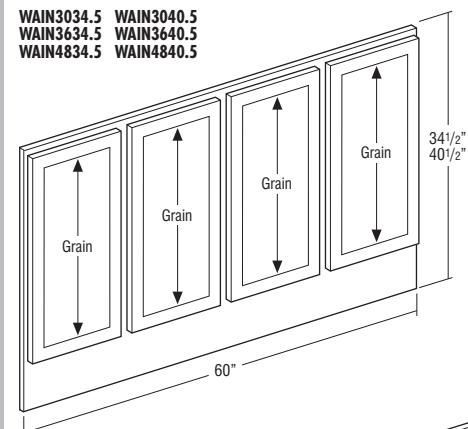

WAIN6034.5 WAIN6040.5

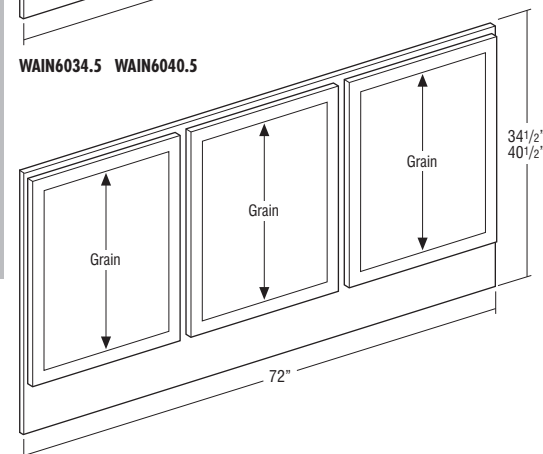

WAIN7234.5 WAIN7240.5

Model	1	2	3	4	5	6
WAIN1534.5	N/A	N/A	N/A	568	621	622
WAIN1834.5	N/A	N/A	N/A	588	661	640
WAIN2134.5	N/A	N/A	N/A	640	718	699
WAIN2434.5	N/A	N/A	N/A	784	868	862
WAIN1540.5	N/A	N/A	N/A	1093	1063	1167
WAIN1840.5	N/A	N/A	N/A	1114	1103	1190
WAIN2140.5	N/A	N/A	N/A	1166	1160	1248
WAIN2440.5	N/A	N/A	N/A	1310	1310	1405

WAIN3034.5	N/A	N/A	N/A	906	993	993
WAIN3634.5	N/A	N/A	N/A	959	1069	1041
WAIN4834.5	N/A	N/A	N/A	1168	1336	1273
WAIN3040.5	N/A	N/A	N/A	1438	1458	1541
WAIN3640.5	N/A	N/A	N/A	1499	1540	1608
WAIN4840.5	N/A	N/A	N/A	1919	1950	2065

WAIN6034.5	N/A	N/A	N/A	1377	1604	1504
WAIN6040.5	N/A	N/A	N/A	2340	2361	2522

WAIN7234.5	N/A	N/A	N/A	1587	1871	1735
WAIN7240.5	N/A	N/A	N/A	2761	2771	2979

- Full Overlay Styles only.
- Panel is 1 1/2" thick including doors. Non-operating doors are applied to 3/4" thick rail and stile frame.
- Flush Toekick standard.
- Wainscoting panel backs are not finished, but are sealed to prevent warping and cracking.
- All faces and edges will be finished.
- If order is placed in Arch door style, panel will have Square doors.
- For use on bars or islands, attach panel by securing the panel face frame through the inside of the applicable cabinet.
- For wall applications, the screw heads used for the panel face frame attachment to the wall can be concealed behind the doors and drawer fronts.

Product Code	Overall Width	Number of Doors	Number of Frame Center Stiles	Door Width
WAIN15..	15"	1	0	14 1/2"
WAIN18..	18"	1	0	17 1/2"
WAIN21..	21"	1	0	20 1/2"
WAIN24..	24"	1	0	23 1/2"
WAIN30..	30"	2	1	14 1/2"
WAIN36..	36"	2	1	17 1/2"
WAIN48..	48"	2	1	23 1/2"
WAIN60..	60"	4	3	14 1/2"
WAIN72..	72"	3	2	23 1/2"

Door height on 34 1/2" high panels is 29 1/2".  
Door height on 40 1/2" high panels is 35 1/2".

Model	7	8	9	10	11	12	13	14	15	16	17	18
WAIN1534.5	624	693	707	735	743	757	787	789	823	845	881	918
WAIN1834.5	646	736	752	783	787	804	834	840	875	898	935	972
WAIN2134.5	706	798	814	844	855	871	908	911	949	974	1015	1053
WAIN2434.5	864	884	905	937	947	965	1006	1007	1049	1080	1124	1169
WAIN1540.5	1179	1180	1194	1230	1238	1257	1293	1298	1340	1366	1411	1458
WAIN1840.5	1202	1223	1239	1278	1282	1304	1340	1349	1392	1419	1465	1512
WAIN2140.5	1261	1285	1301	1340	1350	1371	1413	1419	1465	1495	1545	1593
WAIN2440.5	1419	1371	1392	1432	1443	1465	1511	1515	1565	1601	1654	1709

WAIN3034.5	993	1105	1131	1174	1184	1211	1258	1263	1315	1349	1406	1463
WAIN3634.5	1052	1187	1213	1260	1272	1296	1347	1351	1408	1449	1509	1571
WAIN4834.5	1285	1472	1502	1560	1576	1606	1671	1679	1749	1799	1873	1949
WAIN3040.5	1557	1567	1594	1644	1654	1681	1734	1742	1799	1842	1903	1971
WAIN3640.5	1624	1659	1687	1742	1752	1782	1840	1849	1910	1955	2024	2095
WAIN4840.5	2086	2062	2097	2162	2179	2215	2288	2295	2375	2427	2510	2600

WAIN6034.5	1519	1757	1791	1860	1881	1916	1996	2006	2090	2149	2236	2327
WAIN6040.5	2547	2466	2508	2583	2606	2647	2736	2741	2839	2899	2996	3106

WAIN7234.5	1753	2042	2080	2160	2185	2227	2321	2334	2431	2499	2599	2705
WAIN7240.5	3009	2869	2918	3004	3032	3080	3184	3188	3304	3370	3482	3611

**Custom Modifications**

EXL	FTK	VTK
•	STD	•

**Door Options**

DPSRR
•

**Finish Techniques**

Distressing	Heirlooming
•	•



**DESCRIPTION MODEL PRICE**  
**CUSTOM PANELS & APPLIED DOORS**

All custom panels and doors can be ordered through 20/20. For manual orders, please fax the order form to customer service. See page 536.

Due to customized ordering, Decorative Appliance Panels may not be returned.

**Custom Panels & Doors (DAPNL.. and DADOOR..) square footage requirements are calculated by multiplying the height and width for each panel and door (square footage = width x height (in inches)/144). Premium finish upcharge will be applied.**

**Custom Panels**

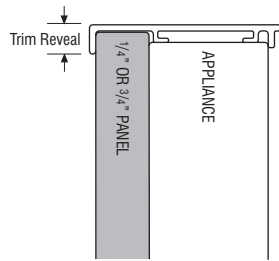

<b>DAPNL1/4</b>	\$42 /sq ft
<b>DAPNL3/4</b>	\$58 /sq ft

- DAPNL1/4 includes 1/4" finished veneer on MDF core, panel cut to fit appliance doors. Panels mount to the appliance using trim kits provided by the appliance supplier.
- DAPNL1/4 is finished on face only, edges are not finished.
- DAPNL3/4 kit includes 3/4" furniture board core veneer panel finished on both sides, and all four edges. Panel is cut to fit appliance doors, and mounts to the appliance using trim kits provided by the appliance supplier.
- Custom sizes available in 1/16" increments.
- DAPNL3/4 can be ordered in APC.

	Maximum Width	Minimum Width	Maximum Height	Minimum Height
DAPNL1/4	48"	5"	96"	5"
DAPNL3/4*	48"	5"	48"	5"
DAPNL3/4**	30"	5"	96"	5"

\*If DAPNL3/4 is 48" high or less  
 \*\*If DAPNL3/4 is greater than 48" high  
 Grain on panels will follow the height dimension (vertical)

**Finish Techniques**

Distressing	Heirlooming
-------------	-------------

**Species Availability (Wood)**

Alder	Rustic Alder	Cherry	Rustic Hickory	Maple	Oak
•	Alder	•	Hickory	•	•

**Species Availability (All Laminates)**

High Gloss box color	Horiz. Grain on Maple box color	Vert. Grain on Maple box color	Vert. Grain on Cherry box color	Vert. Grain on Oak box color
----------------------	---------------------------------	--------------------------------	---------------------------------	------------------------------

**DESCRIPTION MODEL PRICE**

**Custom Panels, Premium**

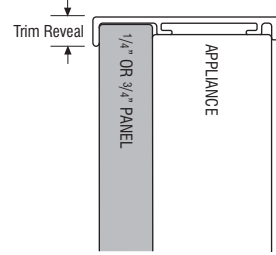

<b>DAPNL1/4P</b>	\$84 /sq ft
<b>DAPNL3/4P</b>	\$116 /sq ft
<b>DAPNL1/4HGP</b>	\$84 /sq ft
<b>DAPNL3/4HGP</b>	\$116 /sq ft

- DAPNL1/4P and DAPNL1/4HGP are 1/4" thick laminated MDF panels cut to fit appliance doors. Laminated on face only, edges are not finished.
- DAPNL3/4P and DAPNL3/4HGP are 3/4" thick laminated MDF panels. Vertical and horizontal grain panels are laminated on both sides with edgebanding on all four edges. High Gloss panels have high gloss on front of panel, back of panel is white melamine. Edgebanding on all four edges will match door and drawer front edgebanding selection.
- DAPNL1/4P and DAPNL3/4P are available for use with Herra or Gallo featuring vertical grain or with Aspen featuring high gloss.
- DAPNL1/4HGP and DAPNL3/4HGP are available for use with Derazi featuring horizontal grain.
- Panel is cut to fit appliance doors, and mounts to the appliance using trim kits provided by the appliance supplier.
- Custom sizes available in 1/16" increments.

Model	Panel Type	Maximum Width	Minimum Width	Maximum Height	Minimum Height
DAPNL1/4P	Vertical Grain or High Gloss	48"	5"	96"	5"
DAPNL3/4P (48" high or less)	Vertical Grain or High Gloss	48"	5"	48"	5"
DAPNL3/4P (>48" high)	Vertical Grain or High Gloss	30"	5"	96"	5"
DAPNL1/4HGP	Horizontal Grain	96"	5"	48"	5"
DAPNL3/4HGP	Horizontal Grain	48"	5"	48"	5"
DAPNL3/4HGP (>48" wide)	Horizontal Grain	96"	5"	30"	5"

**Finish Techniques**

Distressing	Heirlooming
-------------	-------------

**Species Availability (Wood)**

Alder	Rustic Alder	Cherry	Rustic Hickory	Maple	Oak
-------	--------------	--------	----------------	-------	-----

**Species Availability (All Laminates)**

High Gloss	Horiz. Grain on Maple	Vert. Grain on Maple	Vert. Grain on Cherry	Vert. Grain on Oak
•	•*	•	•	•

\*Only available on DAPNL1/4HGP and DAPNL3/4HGP.

**DESCRIPTION**

**MODEL**

**PRICE**

**Custom Doors, No Hinge Routing**

Overlay Application (with Backer Panel)

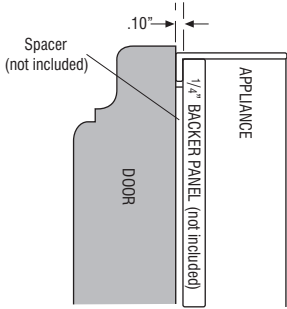

Overlay Application (no Backer Panel)

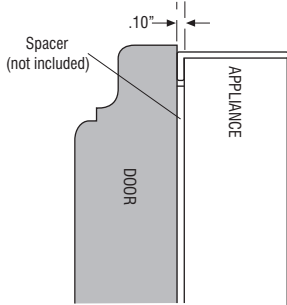

Framed Application

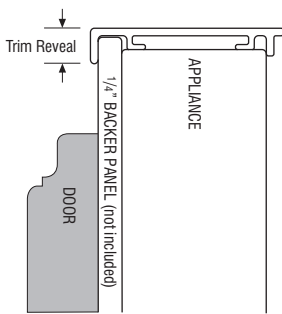

**Square Profile:**

**DADOORB**

\$167 /sq ft

**Arch Profile:**

**DADOORW**

\$167 /sq ft

**Horizontal Grain, Square Profile:**

**DADOORHG**

\$167 /sq ft

- DADOORB is a custom sized door with a square door profile (Arch styles will always be square).
- DADOORW is a custom sized door with the door profile matching the selected door style profile (Arch styles will be Arch).
- DADOORHG is a custom sized door with a square door profile (even when ordered in an Arch style). Stiles and rails are built as doors with a single center panel.
- DADOORHG center panel grain runs horizontal.
- DADOORHG will utilize a flat panel on raised panel styles when width or height is less than 10".
- Includes a 3/4" thick door made to a custom size for the appliance front. No backer panel included.
  - Some appliances require a .10" spacer and/or a 1/4" backer panel.
  - The 1/4" backer panel may be ordered separately (see DAPNLI/4).
- All doors will be specified "NO HINGE ROUTE". Backs may have identification marks, be unfinished, and have 3/16" diameter holes used during finish processing. For these reasons, these doors are not suitable for use as cabinet doors.
- DADOORB and DADOORW not available in Aspen, Derazi, Gallio, Herra, Prestley, and Rivali. DADOORHG not available in Aspen, Derazi, Gallio, Herra, Prestley, Rivali, and Whittaker. For Decorative Appliance Panels, standard door sizes must be ordered.
- Custom sizes available in 1/16" increments.
- CG modification available, maximum size is 23 1/2" x 43" for DADOORB and DADOORW, and 43" x 23 1/2" for DADOORHG.
- Not available on MDF door styles. If desired for use with MDF, order as Maple.

**Finish Techniques**

Distressing	Heirlooming
•	•

	Model	Door Style Type	Available Width Range*	Available Height Range*
	DADOORB and DADOORW	Non-Miter Square or Arch Styles	7 1/2" to 25 7/8" (<3" wide rails/stiles) 8 1/2" to 25 7/8" (3" wide rails/stiles)	7 1/2" to 47 7/16" (<3" wide rails/stiles) 8 1/2" to 47 7/16" (3" wide rails/stiles)
	DADOORB and DADOORW	Non-Miter Square or Arch Styles	7 1/2" to 25 7/8" (<3" wide rails/stiles) 8 1/2" to 25 7/8" (3" wide rails/stiles)	47 1/2" to 82" (<3" wide rails/stiles) 47 1/2" to 82" (3" wide rails/stiles)
	DADOORB and DADOORW	Non-Miter Square Styles	25 15/16" to 35 3/4" (<3" wide rails/stiles) 25 15/16" to 35 3/4" (3" wide rails/stiles)	7 1/2" to 47 7/16" (<3" wide rails/stiles) 8 1/2" to 47 7/16" (3" wide rails/stiles)
	DADOORB and DADOORW	Non-Miter Square Styles	25 15/16" to 35 3/4" (<3" wide rails/stiles) 25 15/16" to 35 3/4" (3" wide rails/stiles)	47 1/2" to 82" (<3" wide rails/stiles) 47 1/2" to 82" (3" wide rails/stiles)
	DADOORB and DADOORW	Miter Styles	8" to 25 7/8"	8" to 61"
	DADOORHG	Non-Miter Square Styles	7 1/2" to 42 1/4" (<3" wide rails/stiles) 8 1/2" to 42 1/4" (3" wide rails/stiles)	7 1/2" to 23 3/4" (<3" wide rails/stiles) 8 1/2" to 23 3/4" (3" wide rails/stiles)
	DADOORHG	Miter Styles	8" to 61"	8" to 24"

\*Any door with a minimum width or height dimension less than 10" will receive a flat center panel.

# DECORATIVE APPLIANCE PANEL ORDER FORM

Use one order form per appliance.  
Refer to Spec Book for door style availability, door style limitations and center panel configurations.

## STEP 1: Provide Order Information\*

Account #: \_\_\_\_\_ PO #: \_\_\_\_\_

Date: \_\_\_\_\_ Order #: \_\_\_\_\_

Bill To: \_\_\_\_\_ Ship To: \_\_\_\_\_

## STEP 2: Appliance Application or No Appliance\* — Circle Choice (For appliance applications, circle one appliance type below per order form)

Appliance Brand Name and Model Number \_\_\_\_\_

Refrigerator/Freezer

Dishwasher/Trash Compactor/  
Ice Maker/Wine Cooler

<b>Single Door</b> 	<b>Side-by-Side</b> 	<b>Side-by-Side w/Dispenser</b> 	<b>Side-by-Side w/Dispenser &amp; TV</b> 	<b>Top/Bottom</b> 	<b>Top/Bottom w/Drawers</b> 	<b>French Door</b> 	<b>Under Counter</b> 
<b>Single Door w/Grill</b> 	<b>Side-by-Side w/Grill</b> 	<b>Side-by-Side w/Dispenser &amp; Grill</b> 	<b>Side-by-Side w/Dispenser/TV &amp; Grill</b> 	<b>Top/Bottom w/Grill</b> 		<b>French Door w/Dispenser</b> 	<b>Under Counter w/Drawers</b> 

<b>Dishwasher Standard</b> 	<b>Dishwasher Standard</b> 	<b>Trash Compactor/ Ice Maker</b> 
<b>Dishwasher Double Drawer</b> 	<b>Dishwasher Single Drawer</b> 	<b>Wine Cooler</b> 

## STEP 3: Provide Dimensions in Inches for Panels and/or Doors Needed as Listed Above\*

Custom Panels — Dimensions for Custom Size Panel(s) and/or Door(s)

DAPNL1/4, DAPNL1/4P, DAPNL3/4, DAPNL3/4P, DAPNL1/4HGP, or DAPNL3/4HGP — Circle Choice

A _____ in. width x _____ in. height = _____ square inches	} total square inches
B _____ in. width x _____ in. height = _____ square inches	
C _____ in. width x _____ in. height = _____ square inches	
D _____ in. width x _____ in. height = _____ square inches	
E _____ in. width x _____ in. height = _____ square inches	

Standard or Custom Doors — Circle Choice

Standard Door Sizes — Dimensions for Panels with Standard Door Sizes (Chosen by Manufacturer)

\*Supply overall dimensions (width and height for each panel only). Doors will be selected by manufacturer to best fit panel dimensions.

DADOORB (Square Profile) and/or DADOORW (Arch Profile) and/or DADOORHG (Horizontal Grain, Square Profile) — Circle Door Choice Below For Each Door

DADOORB or DADOORW or DADOORHG _____ in. width x _____ in. height = _____ square inches	} total square inches
DADOORB or DADOORW or DADOORHG _____ in. width x _____ in. height = _____ square inches	
DADOORB or DADOORW or DADOORHG _____ in. width x _____ in. height = _____ square inches	
DADOORB or DADOORW or DADOORHG _____ in. width x _____ in. height = _____ square inches	
DADOORB or DADOORW or DADOORHG _____ in. width x _____ in. height = _____ square inches	

## STEP 4: Determine Price\* (Refer to Price Book for cost per square foot)

Total square inches from Step 3  ÷ 144 square inches = total square footage x \$  cost per square foot = \$

Total Cost

## STEP 5: Customer Signature\*

\*\*If premium finish is used, multiply total cost by premium upcharge percentage = \$

I accept full responsibility for the accuracy of the design above. Signature:\*

\*ALL FIELDS REQUIRED TO PROCESS ORDER.

**DESCRIPTION**

**MODEL**

**PRICE**

**CUSTOM HINGED DOORS**

**Custom Doors with Hinge Routing**

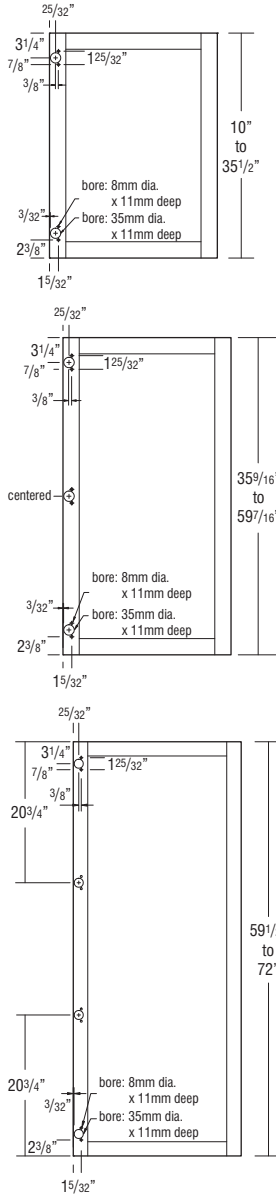

<b>DOORBL</b>	\$167 /sq ft
<b>DOORBR</b>	\$167 /sq ft
<b>DOORWL</b>	\$167 /sq ft
<b>DOORWR</b>	\$167 /sq ft

- Base doors (DOORBL and DOORBR) will always be square.
- Wall doors must specify square/arch.
- Plastic mollies pressed in 8mm holes to accept screws to anchor the hinges to the back of these doors.
- Hinges must be ordered separately and specified full or partial overlay.
- Available in all door styles except Aspen, Derazi, Gallio, Herra, Prestley, and Rivali. For Aspen, Derazi, and Gallio, use DOORSLAB (see page 538). For Herra, Prestley, and Rivali, standard door sizes must be ordered.
- Doors are finished on both sides and routed for hinges.
- CG modification available, maximum size is 23 1/2" x 43".
- Custom dimensions are required when placing order and can be specified in 20/20 or on the order form.
- Not available on MDF door styles. If desired for use with MDF, order as Maple.

**Finish Techniques**

Distressing	Heirlooming
•	•

	Model	Door Style Type	Available Width Range*	Available Height Range
	DOORB.. and DOORW..	Non-Miter Square or Arch Styles	7 1/2" to 24" (<3" wide rails/stiles) 8 1/2" to 24" (3" wide rails/stiles)	10" to 47 7/16" (<3" wide rails/stiles) 10" to 47 7/16" (3" wide rails/stiles)
	DOORB.. and DOORW..	Non-Miter Square or Arch Styles	7 1/2" to 24" (<3" wide rails/stiles) 8 1/2" to 24" (3" wide rails/stiles)	47 1/2" to 72" (<3" wide rails/stiles) 47 1/2" to 72" (3" wide rails/stiles)
	DOORB.. and DOORW..	Miter Styles	8" to 24"	10" to 61"

\*Any door with a minimum width dimension less than 10" will receive a flat center panel.

**Custom Doors with Hinge Routing, Slab Styles**

**DOORSLAB**

\$167 /sq ft

- Available in slab door styles: Aspen, Derazi, Gallio, and Rivali.
- Doors are finished on both sides and routed for hinges.
- Hinges must be ordered separately and specified full overlay.
- Plastic mollies pressed in 8mm holes to accept screws to anchor the hinges to the back of these doors.
- Custom dimensions are required when placing order and can be specified in 20/20 or on the order form.

**Finish Techniques**

Distressing	Heirlooming
-------------	-------------

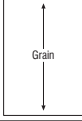
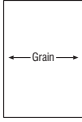
	Model	Door Style Type	Available Width Range	Available Height Range
	DOORSLAB	Vertical Grain or High Glass	5" to 24"	10" to 72"
	DOORSLAB	Horizontal Grain	5" to 24"	10" to 48"

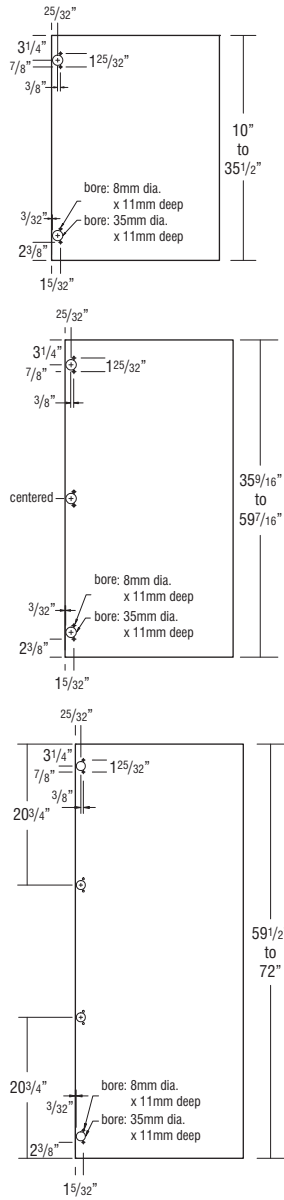

538

CUSTOM HINGED DOORS



All embellishments marked with the follow these guidelines:

**Program Details**

- Products are priced individually with availability and exceptions noted. Finish technique upcharges apply.
- Items will be shipped loose for field attachment.

**Product Characteristics**

- Natural characteristics of wood carved items are wider color range, irregularity of surface texture, and more noticeable variations in finish. It is imperative to understand the variations these characteristics entail and therefore will not be considered defective.

**Ordering Process**

- To ensure product ships with the cabinet order, include on same order. Orders not placed together may not ship together.
- Express Response program is available for 12 day delivery.
- Must specify wood species, finish, and technique, if different than the rest of the order.
- Since these items are ordered on an "as-required" basis, **no changes or cancellations will be accepted after 24 hours from acknowledgment of order.**

**MOULDING SPECIFICATIONS**

Mouldings specified as 8" nominal length have a usable length range of 93" up to 99". Mouldings specified as 10" nominal length have a usable length range of 117" up to 123". Be sure to order the correct amount of moulding length to work around required cuts with minimal butt joints.

DESCRIPTION	MODEL	PRICE
<b>CROWN MOULDING</b>		

**CLASSIC TALL CROWN**



<b>CLTCROWN8</b>	382
<b>CLTCROWN10 ♦</b>	516

- CLTCROWN8 is one 8" section.
- CLTCROWN10 is one 10" section. 5 day Express Response not available.
- Cleat shipped unattached can be used for top mount or face frame applications.

**Finish Techniques**

Distressing	Heirlooming
•	•

**Species Availability (Wood)**

Alder	Rustic Alder	Cherry	Rustic Hickory	Maple	Oak
•	•	•	•	•	•

♦ Only available in Cherry and Maple.

**Species Availability (All Laminates)**

High Gloss	Horiz. Grain on Maple	Vert. Grain on Maple	Vert. Grain on Cherry	Vert. Grain on Oak
box color	box color	box color	box color	box color

♦ Only available in Cherry and Maple box colors.

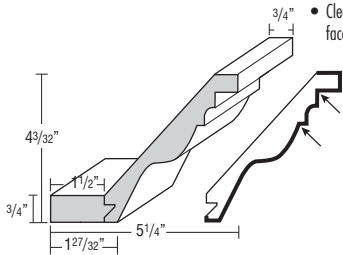

**CORNICE TALL CROWN**



<b>COTCROWN8</b>	382
<b>COTCROWN10 ♦</b>	516

- COTCROWN8 is one 8" section.
- COTCROWN10 is one 10" section. 5 day Express Response not available.
- Cleat shipped unattached can be used for top mount or face frame applications.

**Finish Techniques**

Distressing	Heirlooming
•	•

**Species Availability (Wood)**

Alder	Rustic Alder	Cherry	Rustic Hickory	Maple	Oak
•	•	•	•	•	•

♦ Only available in Cherry and Maple.

**Species Availability (All Laminates)**

High Gloss	Horiz. Grain on Maple	Vert. Grain on Maple	Vert. Grain on Cherry	Vert. Grain on Oak
box color	box color	box color	box color	box color

♦ Only available in Cherry and Maple box colors.

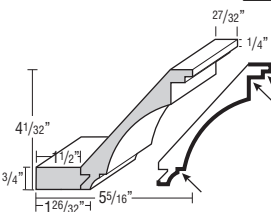

DESCRIPTION	MODEL	PRICE
-------------	-------	-------

**COVE CROWN**



<b>COVECROWN8</b>	382
<b>COVECROWN10 ♦</b>	516

- COVECROWN8 is one 8" section.
- COVECROWN10 is one 10" section. 5 day Express Response not available.
- Cleat shipped unattached can be used for top mount or face frame applications.

**Finish Techniques**

Distressing	Heirlooming
•	•

**Species Availability (Wood)**

Alder	Rustic Alder	Cherry	Rustic Hickory	Maple	Oak
•	•	•	•	•	•

♦ Only available in Cherry and Maple.

**Species Availability (All Laminates)**

High Gloss	Horiz. Grain on Maple	Vert. Grain on Maple	Vert. Grain on Cherry	Vert. Grain on Oak
box color	box color	box color	box color	box color

♦ Only available in Cherry and Maple box colors.

**FULL OVERLAY CROWN**



<b>FOLCROWN8</b>	303
------------------	-----

- One 8" section.
- Attached cleat for top-mount application.

**Finish Techniques**

Distressing	Heirlooming
	•

**Species Availability (Wood)**

Alder	Rustic Alder	Cherry	Rustic Hickory	Maple	Oak
•	•	•	•	•	•

**Species Availability (All Laminates)**

High Gloss	Horiz. Grain on Maple	Vert. Grain on Maple	Vert. Grain on Cherry	Vert. Grain on Oak
box color	box color	box color	box color	box color

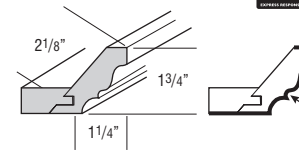

**INSERT CROWN**



<b>INSCROWN8</b>	426
------------------	-----

- One 8" section.
- Designed for use with all 2 1/4" insert mouldings.

**Finish Techniques**

Distressing	Heirlooming
	•

**Species Availability (Wood)**

Alder	Rustic Alder	Cherry	Rustic Hickory	Maple	Oak
•	Alder	•		•	•

**Species Availability (All Laminates)**

High Gloss	Horiz. Grain on Maple	Vert. Grain on Maple	Vert. Grain on Cherry	Vert. Grain on Oak
box color	box color	box color	box color	box color

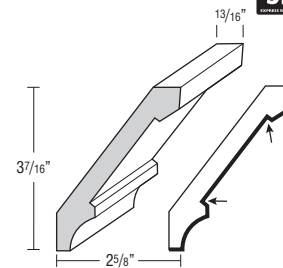

Finished edges indicated by bold lines on side view drawings.  
Glazed edges indicated by arrows on side view drawings.

**DESCRIPTION MODEL PRICE**

**LARGE STRAIGHT ANGLE CROWN**



**LSACROWN8 297**  
**LSACROWN10 ♦ 401**

- LSACROWN8 is one 8" section.
- LSACROWN10 is one 10" section. 5 day Express Response not available.
- Cleat shipped unattached can be used for top mount or face frame applications.

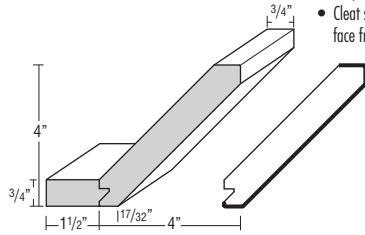

**Finish Techniques**

Distressing	Heirlooming
•	•

**Species Availability (Wood)**

Alder	Rustic Alder	Cherry	Rustic Hickory	Maple	Oak
•	•	•	•	•	•

♦ Only available in Cherry and Maple.

**Species Availability (All Laminates)**

High Gloss	Horiz. Grain on Maple	Vert. Grain on Maple	Vert. Grain on Cherry	Vert. Grain on Oak
box color	box color	box color	box color	box color

♦ Only available in Cherry and Maple box colors.

**MEDIUM STRAIGHT ANGLE CROWN**



**MSACROWN8 268**  
**MSACROWN10 ♦ 361**

- MSACROWN8 is one 8" section.
- MSACROWN10 is one 10" section. 5 day Express Response not available.
- Cleat shipped unattached can be used for top mount or face frame applications.

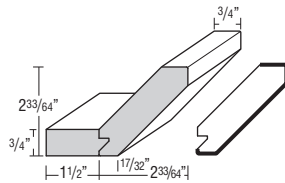

**Finish Techniques**

Distressing	Heirlooming
•	•

**Species Availability (Wood)**

Alder	Rustic Alder	Cherry	Rustic Hickory	Maple	Oak
•	•	•	•	•	•

♦ Only available in Cherry and Maple.

**Species Availability (All Laminates)**

High Gloss	Horiz. Grain on Maple	Vert. Grain on Maple	Vert. Grain on Cherry	Vert. Grain on Oak
box color	box color	box color	box color	box color

♦ Only available in Cherry and Maple box colors.

**STRAIGHT ANGLE CROWN**



**SACROWN8 250**  
**SACROWN10 ♦ 337**

- SACROWN8 is one 8" section.
- SACROWN10 is one 10" section. 5 day Express Response not available.
- Cleat shipped unattached can be used for top mount or face frame applications.

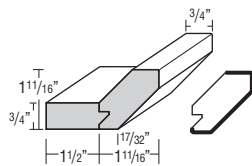

**Finish Techniques**

Distressing	Heirlooming
•	•

**Species Availability (Wood)**

Alder	Rustic Alder	Cherry	Rustic Hickory	Maple	Oak
•	•	•	•	•	•

♦ Only available in Cherry and Maple.

**Species Availability (All Laminates)**

High Gloss	Horiz. Grain on Maple	Vert. Grain on Maple	Vert. Grain on Cherry	Vert. Grain on Oak
box color	box color	box color	box color	box color

♦ Only available in Cherry and Maple box colors.

**DESCRIPTION MODEL PRICE**

**TALL CROWN**



**MTCROWN8 268**  
**MTCROWN10 ♦ 361**

- MTCROWN8 is one 8" section.
- MTCROWN10 is one 10" section. 5 day Express Response not available.

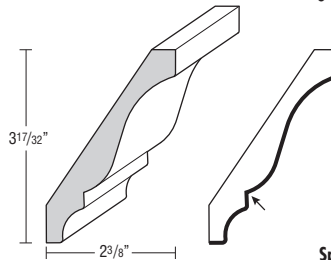

**Finish Techniques**

Distressing	Heirlooming
•	•

**Species Availability (Wood)**

Alder	Rustic Alder	Cherry	Rustic Hickory	Maple	Oak
•	•	•	•	•	•

♦ Only available in Cherry and Maple.

**Species Availability (All Laminates)**

High Gloss	Horiz. Grain on Maple	Vert. Grain on Maple	Vert. Grain on Cherry	Vert. Grain on Oak
box color	box color	box color	box color	box color

♦ Only available in Cherry and Maple box colors.

**SHAKER CROWN**



**SHKRCRM8 194**

- Top mount moulding.
- One 8" section.

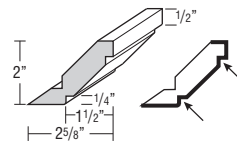

**Finish Techniques**

Distressing	Heirlooming
•	•

**Species Availability (Wood)**

Alder	Rustic Alder	Cherry	Rustic Hickory	Maple	Oak
•	•	•	•	•	•

**Species Availability (All Laminates)**

High Gloss	Horiz. Grain on Maple	Vert. Grain on Maple	Vert. Grain on Cherry	Vert. Grain on Oak
box color	box color	box color	box color	box color

**LARGE SHAKER CROWN**



**LSHAKER8 194**  
**LSHAKER10 ♦ 260**

- LSHAKER8 is one 8" section.
- LSHAKER10 is one 10" section. 5 day Express Response not available.

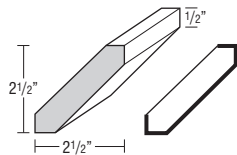

**Finish Techniques**

Distressing	Heirlooming
•	•

**Species Availability (Wood)**

Alder	Rustic Alder	Cherry	Rustic Hickory	Maple	Oak
•	•	•	•	•	•

♦ Only available in Cherry and Maple.

**Species Availability (All Laminates)**

High Gloss	Horiz. Grain on Maple	Vert. Grain on Maple	Vert. Grain on Cherry	Vert. Grain on Oak
box color	box color	box color	box color	box color

♦ Only available in Cherry and Maple box colors.

Finished edges indicated by bold lines on side view drawings.  
 Glazed edges indicated by arrows on side view drawings.

**DESCRIPTION**

**MODEL**

**PRICE**

**LARGE SHAKER CROWN, PREMIUM**



**LSHAKER8P**

581

**LSHAKER10P**

784

- LSHAKER8P is one 8' section.
- LSHAKER10P is one 10' section. 5 day Express Response not available.
- Horizontal grain except on High Gloss.

**Finish Techniques**

Distressing	Heirlooming

**Species Availability (Wood)**

Rustic Alder	Rustic Alder	Cherry	Rustic Hickory	Maple	Oak

**Species Availability (All Laminates)**

High Gloss	Horiz. Grain on Maple	Vert. Grain on Maple	Vert. Grain on Cherry	Vert. Grain on Oak
•	•	•*	•*	•*

\*LSHAKER10P not available in Gunstock and Icy Avalanche Linea Nightfall.

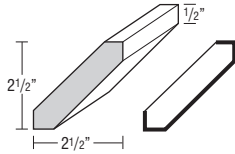

**SMALL COVE CROWN MOULDING**



**SMCOVECROWN8**

345

**SMCOVECROWN10 ♦**

466

- SMCOVECROWN8 is one 8' section.
- SMCOVECROWN10 is one 10' section. 5 day Express Response not available.

**Finish Techniques**

Distressing	Heirlooming
•	•

**Species Availability (Wood)**

Rustic Alder	Rustic Alder	Cherry	Rustic Hickory	Maple	Oak
•	•	•	•	•	•

♦ Only available in Cherry and Maple.

**Species Availability (All Laminates)**

High Gloss	Horiz. Grain on Maple	Vert. Grain on Maple	Vert. Grain on Cherry	Vert. Grain on Oak
box color	box color	box color	box color	box color

♦ Only available in Cherry and Maple box colors.

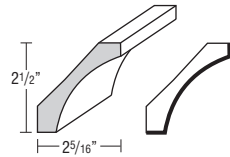

**SMALL CROWN**



**SCM8**

138

**SCM10 ♦**

186

- Face mounts on Partial Overlay doors. May be face mounted on Full Overlay if used with a cleat.
- SCM8 is one 8' section.
- SCM10 is one 10' section. 5 day Express Response not available.
- Moulding can be used as standard or inverted.

**Finish Techniques**

Distressing	Heirlooming
•	•

**Species Availability (Wood)**

Rustic Alder	Rustic Alder	Cherry	Rustic Hickory	Maple	Oak
•	•	•	•	•	•

♦ Only available in Cherry and Maple.

**Species Availability (All Laminates)**

High Gloss	Horiz. Grain on Maple	Vert. Grain on Maple	Vert. Grain on Cherry	Vert. Grain on Oak
box color	box color	box color	box color	box color

♦ Only available in Cherry and Maple box colors.

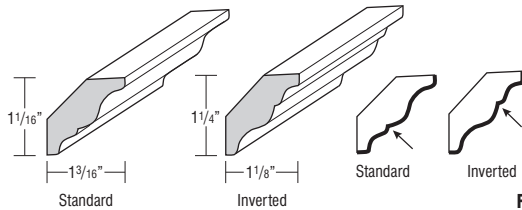

**DESCRIPTION**

**MODEL**

**PRICE**

**SOLID-WOOD CROWN**



**SWCRM8**

148

**SWCRM10 ♦**

199

- Face mounts on Partial Overlay doors. May be face mounted on Full Overlay if used with a cleat.
- SWCRM8 is one 8' section.
- SWCRM10 is one 10' section. 5 day Express Response not available.
- Moulding can be used as standard or inverted.

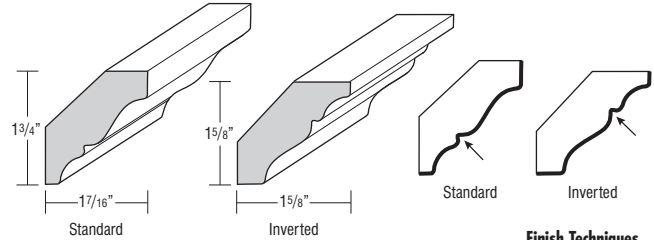

**Finish Techniques**

Distressing	Heirlooming
•	•

**Species Availability (Wood)**

Rustic Alder	Rustic Alder	Cherry	Rustic Hickory	Maple	Oak
•	•	•	•	•	•

♦ Only available in Cherry and Maple.

**Species Availability (All Laminates)**

High Gloss	Horiz. Grain on Maple	Vert. Grain on Maple	Vert. Grain on Cherry	Vert. Grain on Oak
box color	box color	box color	box color	box color

♦ Only available in Cherry and Maple box colors.

**SOLID-WOOD LARGE CROWN**



**SWLCRM8**

250

**SWLCRM10 ♦**

337

- Face mounts on Partial Overlay doors. May be face mounted on Full Overlay if used with a cleat.
- SWLCRM8 is one 8' section.
- SWLCRM10 is one 10' section. 5 day Express Response not available.
- Moulding can be used as standard or inverted.

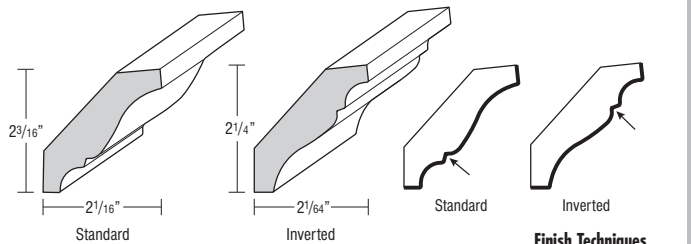

**Finish Techniques**

Distressing	Heirlooming
•	•

**Species Availability (Wood)**

Rustic Alder	Rustic Alder	Cherry	Rustic Hickory	Maple	Oak
•	•	•	•	•	•

♦ Only available in Cherry and Maple.

**Species Availability (All Laminates)**

High Gloss	Horiz. Grain on Maple	Vert. Grain on Maple	Vert. Grain on Cherry	Vert. Grain on Oak
box color	box color	box color	box color	box color

♦ Only available in Cherry and Maple box colors.

Finished edges indicated by bold lines on side view drawings.  
Glazed edges indicated by arrows on side view drawings.



**DESCRIPTION MODEL PRICE**

**SOLID-WOOD TALL CROWN**



<b>SWTCRM8</b>	268
<b>SWTCRM10</b> ♦	361

- Face mounts on Partial Overlay doors. May be face mounted on Full Overlay if used with a cleat.
- SWTCRM8 is one 8' section.
- SWTCRM10 is one 10' section. 5 day Express Response not available.
- Moulding can be used as standard or inverted.

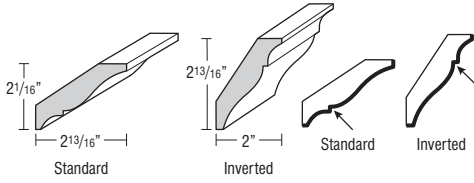

**Finish Techniques**

Distressing	Heirlooming
•	•

**Species Availability (Wood)**

Alder	Rustic Alder	Cherry	Rustic Hickory	Maple	Oak
•	•	•	Hickory	•	•

♦ Only available in Cherry and Maple.

**Species Availability (All Laminates)**

High Gloss	Horiz. Grain on Maple	Vert. Grain on Maple	Vert. Grain on Cherry	Vert. Grain on Oak
box color	box color	box color	box color	box color

♦ Only available in Cherry and Maple box colors.

**SOLID-WOOD VICTORIAN CROWN**



<b>SWVCRM8</b>	297
<b>SWVCRM10</b> ♦	401

- Face mounts on Partial Overlay doors. May be face mounted on Full Overlay if used with a cleat.
- Designed for braided, dentil, egg & dart, or rope moulding application.
- SWVCRM8 is one 8' section.
- SWVCRM10 is one 10' section. 5 day Express Response not available.

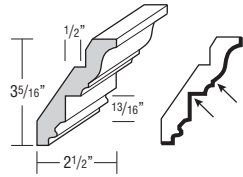

**Finish Techniques**

Distressing	Heirlooming
•	•

**Species Availability (Wood)**

Alder	Rustic Alder	Cherry	Rustic Hickory	Maple	Oak
•	•	•	Hickory	•	•

♦ Only available in Cherry and Maple.

**Species Availability (All Laminates)**

High Gloss	Horiz. Grain on Maple	Vert. Grain on Maple	Vert. Grain on Cherry	Vert. Grain on Oak
box color	box color	box color	box color	box color

♦ Only available in Cherry and Maple box colors.

**DESCRIPTION MODEL PRICE**

**STARTER MOULDINGS**

**SOFFIT FILLER MOULDING**



<b>SFM8</b>	448
<b>SFM10</b> ♦	604

- SFM8 is one 8' section.
- SFM10 is one 10' section. 5 day Express Response not available.
- Includes an unattached cleat.

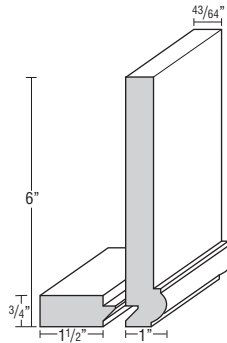

**Finish Techniques**

Distressing	Heirlooming
•	•

**Species Availability (Wood)**

Alder	Rustic Alder	Cherry	Rustic Hickory	Maple	Oak
•	•	•	Hickory	•	•

♦ Only available in Cherry and Maple.

**Species Availability (All Laminates)**

High Gloss	Horiz. Grain on Maple	Vert. Grain on Maple	Vert. Grain on Cherry	Vert. Grain on Oak
box color	box color	box color	box color	box color

♦ Only available in Cherry and Maple box colors.

**STARTER MOULDING**



<b>STR8</b>	457
<b>STR10</b> ♦	618

- STR8 is one 8' section.
- STR10 is one 10' section. 5 day Express Response not available.
- Attached cleat for top-mount application.

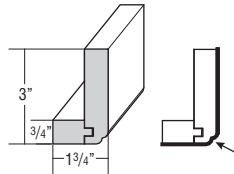

**Finish Techniques**

Distressing	Heirlooming

**Species Availability (Wood)**

Alder	Rustic Alder	Cherry	Rustic Hickory	Maple	Oak
•	•	•	Hickory	•	•

♦ Only available in Cherry and Maple.

**Species Availability (All Laminates)**

High Gloss	Horiz. Grain on Maple	Vert. Grain on Maple	Vert. Grain on Cherry	Vert. Grain on Oak
box color	box color	box color	box color	box color

♦ Only available in Cherry and Maple box colors.

**STARTER MOULDING, SHAKER**



<b>STRS8</b>	398
<b>STRS10</b> ♦	524

- STRS8 is one 8' section.
- STRS10 is one 10' section. 5 day Express Response not available.
- Attached cleat for top-mount application.

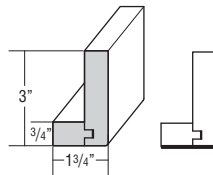

**Finish Techniques**

Distressing	Heirlooming
•	•

**Species Availability (Wood)**

Alder	Rustic Alder	Cherry	Rustic Hickory	Maple	Oak
•	•	•	Hickory	•	•

♦ Only available in Cherry and Maple.

**Species Availability (All Laminates)**

High Gloss	Horiz. Grain on Maple	Vert. Grain on Maple	Vert. Grain on Cherry	Vert. Grain on Oak
box color	box color	box color	box color	box color

♦ Only available in Cherry and Maple box colors.

Finished edges indicated by bold lines on side view drawings.  
Glazed edges indicated by arrows on side view drawings.

**DESCRIPTION**

**MODEL**

**PRICE**

**STARTER MOULDING, SHAKER PREMIUM**



**STRS8P**

995

- One 8' section.
- Horizontal grain except on High Gloss.

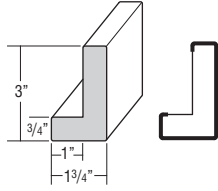

**Finish Techniques**

Distressing	Heirloom
-------------	----------

**Species Availability (Wood)**

	Rustic Alder	Cherry	Rustic Hickory	Maple	Oak

**Species Availability (All Laminates)**

High Gloss	Horiz. Grain on Maple	Vert. Grain on Maple	Vert. Grain on Cherry	Vert. Grain on Oak
•	•	•	•	•

**DESCRIPTION**

**MODEL**

**PRICE**

**EGG & DART**



**EGD8**

111

- Designed to face mount on SWVCRM8.
- One 8' section.

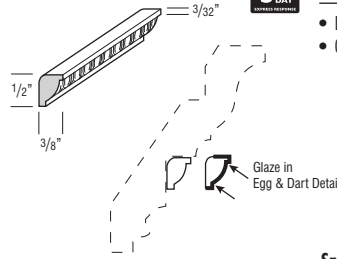

**Finish Techniques**

Distressing	Heirloom
-------------	----------

**Species Availability (Wood)**

	Rustic Alder	Cherry	Rustic Hickory	Maple	Oak
				•	

**Species Availability (All Laminates)**

High Gloss	Horiz. Grain on Maple	Vert. Grain on Maple	Vert. Grain on Cherry	Vert. Grain on Oak
box color	box color	box color		

**MOULDING INSERTS**

**BRAIDED**



**BRAIDM**

203

- Designed to face mount on SWVCRM8.
- One 8' section.

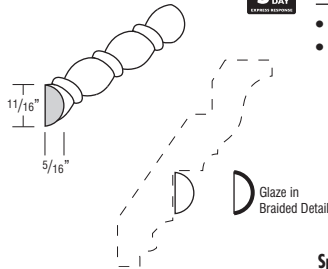

**Finish Techniques**

Distressing	Heirloom
-------------	----------

**Species Availability (Wood)**

	Rustic Alder	Cherry	Rustic Hickory	Maple	Oak
	• Alder	•	• Beech	•	• Beech

**Species Availability (All Laminates)**

High Gloss	Horiz. Grain on Maple	Vert. Grain on Maple	Vert. Grain on Cherry	Vert. Grain on Oak
box color	box color	box color	box color	box color

**ROPE**



**RPM8**

111

- Designed to face mount on SWVCRM8.
- One 8' section.

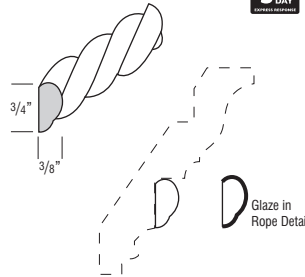

**Finish Techniques**

Distressing	Heirloom
-------------	----------

**Species Availability (Wood)**

	Rustic Alder	Cherry	Rustic Hickory	Maple	Oak
	• Alder	•	• Hickory	•	•

**Species Availability (All Laminates)**

High Gloss	Horiz. Grain on Maple	Vert. Grain on Maple	Vert. Grain on Cherry	Vert. Grain on Oak
box color	box color	box color	box color	box color

**CELTIC INSERT**



**INSERTCELT**

853

- One 8' section.
- Designed to be used with Insert Crown.
- Pattern is 6" repeat.

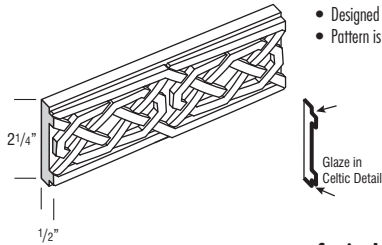

**Finish Techniques**

Distressing	Heirloom
-------------	----------

**Species Availability (Wood)**

	Rustic Alder	Cherry	Rustic Hickory	Maple	Oak
	• Alder	•	• Beech	•	• Beech

**Species Availability (All Laminates)**

High Gloss	Horiz. Grain on Maple	Vert. Grain on Maple	Vert. Grain on Cherry	Vert. Grain on Oak
box color	box color	box color	box color	box color

**ACCENT MOULDING**

**ACANTHUS**



**ACAM**

353

- One 8' section.

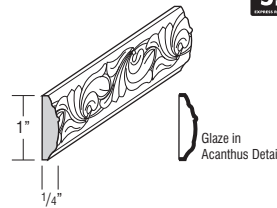

**Finish Techniques**

Distressing	Heirloom
-------------	----------

**Species Availability (Wood)**

	Rustic Alder	Cherry	Rustic Hickory	Maple	Oak
	• Alder	•	• Beech	•	• Beech

**Species Availability (All Laminates)**

High Gloss	Horiz. Grain on Maple	Vert. Grain on Maple	Vert. Grain on Cherry	Vert. Grain on Oak
box color	box color	box color	box color	Beech

**DENTIL**



**MDENTIL8**

84

- Designed to face mount on SWVCRM8.
- One 8' section.

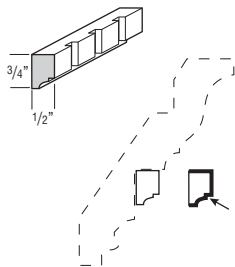

**Finish Techniques**

Distressing	Heirloom
-------------	----------

**Species Availability (Wood)**

	Rustic Alder	Cherry	Rustic Hickory	Maple	Oak
	• Alder	•	•	•	•

**Species Availability (All Laminates)**

High Gloss	Horiz. Grain on Maple	Vert. Grain on Maple	Vert. Grain on Cherry	Vert. Grain on Oak
box color	box color	box color	box color	box color

**BACK PANEL MOULDING**



**BPM8**

123

- One 8' section.
- Designed to provide a decorative edge between cabinet and panel-corner seam.

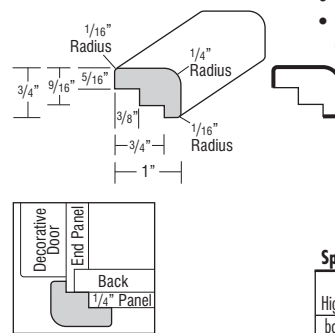

**Finish Techniques**

Distressing	Heirloom
-------------	----------

**Species Availability (Wood)**

	Rustic Alder	Cherry	Rustic Hickory	Maple	Oak
	• Alder	•	• Hickory	•	•

**Species Availability (All Laminates)**

High Gloss	Horiz. Grain on Maple	Vert. Grain on Maple	Vert. Grain on Cherry	Vert. Grain on Oak
box color	box color	box color	box color	box color

Finished edges indicated by bold lines on side view drawings.  
Glazed edges indicated by arrows on side view drawings.

**DESCRIPTION MODEL PRICE**

**CABINET PANEL EDGE**



**CPE8 177**

- One 8' section.

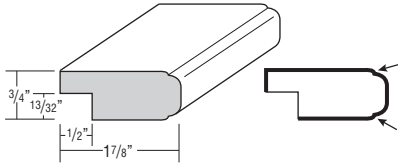

**Finish Techniques**

Distressing	Heirlooming
	•

**Species Availability (Wood)**

Alder	Rustic Alder	Cherry	Rustic Hickory	Maple	Oak
•	•	•	•	•	•

**Species Availability (All Laminates)**

High Gloss box color	Horiz. Grain on Maple box color	Vert. Grain on Maple box color	Vert. Grain on Cherry box color	Vert. Grain on Oak box color
----------------------	---------------------------------	--------------------------------	---------------------------------	------------------------------

**COUNTERTOP EDGE**



**CCM8 94**

**Contemporary**

**Traditional**

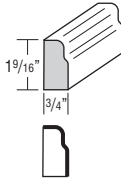
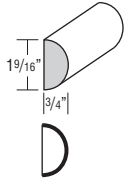

**TCM8 94**

- One 8' section.

**Finish Techniques**

Distressing	Heirlooming
	•*

\*Available on TCM8 only

**Species Availability (Wood)**

Alder	Rustic Alder	Cherry	Rustic Hickory	Maple	Oak
•	•	•	•	•	•

**Species Availability (All Laminates)**

High Gloss box color	Horiz. Grain on Maple box color	Vert. Grain on Maple box color	Vert. Grain on Cherry box color	Vert. Grain on Oak box color
----------------------	---------------------------------	--------------------------------	---------------------------------	------------------------------

**FLAT SCRIBE**



**SM8 67**

**SM10 ♦ 90**

- SM8 is one 8' section.
- SM10 is one 10' section. 5 day Express Response not available.

**Finish Techniques**

Distressing	Heirlooming

**Species Availability (Wood)**

Alder	Rustic Alder	Cherry	Rustic Hickory	Maple	Oak
•	•	•	•	•	•

♦ Only available in Cherry and Maple.

**Species Availability (All Laminates)**

High Gloss box color	Horiz. Grain on Maple box color	Vert. Grain on Maple box color	Vert. Grain on Cherry box color	Vert. Grain on Oak box color
----------------------	---------------------------------	--------------------------------	---------------------------------	------------------------------

♦ Only available in Cherry and Maple box colors.

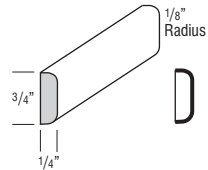

**DESCRIPTION MODEL PRICE**

**FLAT SCRIBE, PREMIUM**



**SM8P 173**

**SM10P 234**

- SM8P is one 8' section.
- SM10P is one 10' section. 5 day Express Response not available.
- Horizontal grain except on High Gloss.

**Finish Techniques**

Distressing	Heirlooming

**Species Availability (Wood)**

Alder	Rustic Alder	Cherry	Rustic Hickory	Maple	Oak

**Species Availability (All Laminates)**

High Gloss box color	Horiz. Grain on Maple box color	Vert. Grain on Maple box color	Vert. Grain on Cherry box color	Vert. Grain on Oak box color
•	•	•*	•*	•*

\*SM10P not available in Gunstock and Icy Avalanche Linea Nightfall.

**LIBRARY MOULDING**



**LBRM 325**

- One 8' section.

**Finish Techniques**

Distressing	Heirlooming
•	•

**Species Availability (Wood)**

Alder	Rustic Alder	Cherry	Rustic Hickory	Maple	Oak
•	•	•	•	•	•

**Species Availability (All Laminates)**

High Gloss box color	Horiz. Grain on Maple box color	Vert. Grain on Maple box color	Vert. Grain on Cherry box color	Vert. Grain on Oak box color
----------------------	---------------------------------	--------------------------------	---------------------------------	------------------------------

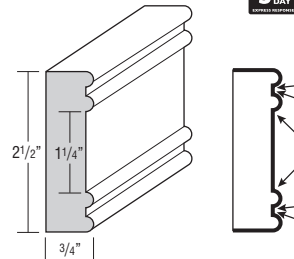

**MIRROR FRAME**



**WMF8 136**

- Pre-glazed.
- One 8' section.

**Finish Techniques**

Distressing	Heirlooming
•	•

**Species Availability (Wood)**

Alder	Rustic Alder	Cherry	Rustic Hickory	Maple	Oak
•	•	•	•	•	•

**Species Availability (All Laminates)**

High Gloss box color	Horiz. Grain on Maple box color	Vert. Grain on Maple box color	Vert. Grain on Cherry box color	Vert. Grain on Oak box color
----------------------	---------------------------------	--------------------------------	---------------------------------	------------------------------

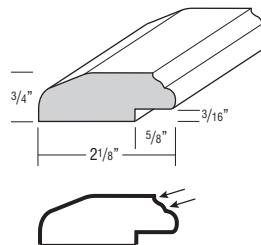

**OGEE EDGE**



**OGEEM 116**

- One 8' section.

**Finish Techniques**

Distressing	Heirlooming
	•

**Species Availability (Wood)**

Alder	Rustic Alder	Cherry	Rustic Hickory	Maple	Oak
•	•	•	•	•	•

**Species Availability (All Laminates)**

High Gloss box color	Horiz. Grain on Maple box color	Vert. Grain on Maple box color	Vert. Grain on Cherry box color	Vert. Grain on Oak box color
----------------------	---------------------------------	--------------------------------	---------------------------------	------------------------------

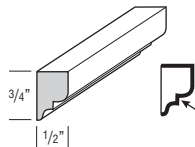

Finished edges indicated by bold lines on side view drawings.  
Glazed edges indicated by arrows on side view drawings.

**DESCRIPTION**

**MODEL**

**PRICE**

**SINGLE BEAD EDGE**



**SBE8**

116

- One 8" section.

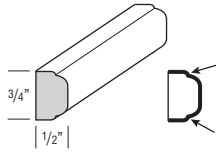

**Finish Techniques**

Distressing	Heirloom
	•

**Species Availability (Wood)**

Alder	Rustic Alder	Cherry	Rustic Hickory	Maple	Oak
•	Alder	•	Hickory	•	•

**Species Availability (All Laminates)**

High Gloss box color	Horiz. Grain on Maple box color	Vert. Grain on Maple box color	Vert. Grain on Cherry box color	Vert. Grain on Oak box color
----------------------	---------------------------------	--------------------------------	---------------------------------	------------------------------

**SINGLE BEAD MOULDING**



**SBM8**

297

- One 8" section.

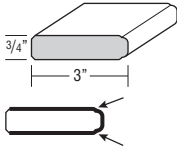

**Finish Techniques**

Distressing	Heirloom
	•

**Species Availability (Wood)**

Alder	Rustic Alder	Cherry	Rustic Hickory	Maple	Oak
•	Alder	•	Hickory	•	•

**Species Availability (All Laminates)**

High Gloss box color	Horiz. Grain on Maple box color	Vert. Grain on Maple box color	Vert. Grain on Cherry box color	Vert. Grain on Oak box color
----------------------	---------------------------------	--------------------------------	---------------------------------	------------------------------

**SINGLE BEAD PILASTER**



**SBP8**

290

- One 8" section.
- Can be used vertically between cabinets for an inset look.

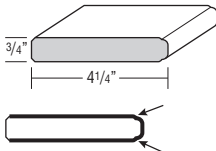

**Finish Techniques**

Distressing	Heirloom
	•

**Species Availability (Wood)**

Alder	Rustic Alder	Cherry	Rustic Hickory	Maple	Oak
•	Alder	•	Hickory	•	•

**Species Availability (All Laminates)**

High Gloss box color	Horiz. Grain on Maple box color	Vert. Grain on Maple box color	Vert. Grain on Cherry box color	Vert. Grain on Oak box color
----------------------	---------------------------------	--------------------------------	---------------------------------	------------------------------

**SMALL SCRIBE**



**SSM8**

57

**SSM10 ♦**

79

- SSM8 is one 8" section.
- SSM10 is one 10" section. 5 day Express Response not available.

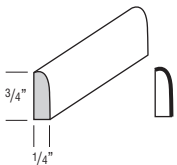

**Finish Techniques**

Distressing	Heirloom
	•

**Species Availability (Wood)**

Alder	Rustic Alder	Cherry	Rustic Hickory	Maple	Oak
•	Alder	•	Hickory	•	•

♦ Only available in Cherry and Maple.

**Species Availability (All Laminates)**

High Gloss box color	Horiz. Grain on Maple box color	Vert. Grain on Maple box color	Vert. Grain on Cherry box color	Vert. Grain on Oak box color
----------------------	---------------------------------	--------------------------------	---------------------------------	------------------------------

♦ Only available in Cherry and Maple box colors.

**DESCRIPTION**

**MODEL**

**PRICE**

**SMALL SCRIBE, PREMIUM**



**SSM8P**

173

**SSM10P**

234

- SSM8P is one 8" section.
- SSM10P is one 10" section. 5 day Express Response not available.
- Horizontal grain except on High Gloss.

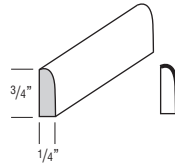

**Finish Techniques**

Distressing	Heirloom
	•

**Species Availability (Wood)**

Alder	Rustic Alder	Cherry	Rustic Hickory	Maple	Oak

**Species Availability (All Laminates)**

High Gloss	Horiz. Grain on Maple	Vert. Grain on Maple	Vert. Grain on Cherry	Vert. Grain on Oak
•	•	•*	•*	•*

\*SSM10P not available in Gunstock and Icy Avalanche Linea Nightfall.

**SOFFIT TRIM MOULDING**



**TSTM8**

209

**TSTM10 ♦**

283

- TSTM8 is one 8" section.
- TSTM10 is one 10" section. 5 day Express Response not available.

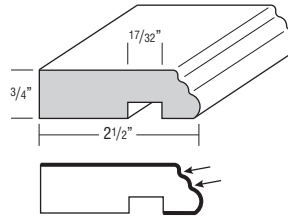

**Finish Techniques**

Distressing	Heirloom
	•

**Species Availability (Wood)**

Alder	Rustic Alder	Cherry	Rustic Hickory	Maple	Oak
•	Alder	•	Hickory	•	•

♦ Only available in Cherry and Maple.

**Species Availability (All Laminates)**

High Gloss box color	Horiz. Grain on Maple box color	Vert. Grain on Maple box color	Vert. Grain on Cherry box color	Vert. Grain on Oak box color
----------------------	---------------------------------	--------------------------------	---------------------------------	------------------------------

♦ Only available in Cherry and Maple box colors.

**TRIPLE BEAD EDGE**



**TBEM**

121

- One 8" section.

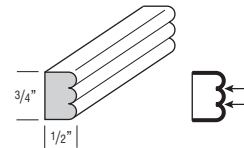

**Finish Techniques**

Distressing	Heirloom
	•

**Species Availability (Wood)**

Alder	Rustic Alder	Cherry	Rustic Hickory	Maple	Oak
•	Alder	•	Hickory	•	•

**Species Availability (All Laminates)**

High Gloss box color	Horiz. Grain on Maple box color	Vert. Grain on Maple box color	Vert. Grain on Cherry box color	Vert. Grain on Oak box color
----------------------	---------------------------------	--------------------------------	---------------------------------	------------------------------

Finished edges indicated by bold lines on side view drawings.  
Glazed edges indicated by arrows on side view drawings.

**DESCRIPTION MODEL PRICE**

**TRIPLE BEAD PILASTER**



**TBP8 297**

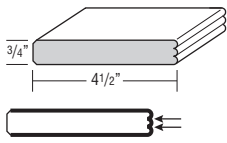

- Finished beaded front and two 4 1/2" sides.
- Can be used vertically between cabinets for an inset look.
- One 8' section.

**Finish Techniques**

Distressing	Heirlooming
	•

**Species Availability (Wood)**

Alder	Rustic Alder	Cherry	Rustic Hickory	Maple	Oak
•	•	•	•	•	•

**Species Availability (All Laminates)**

High Gloss box color	Horiz. Grain on Maple box color	Vert. Grain on Maple box color	Vert. Grain on Cherry box color	Vert. Grain on Oak box color
----------------------	---------------------------------	--------------------------------	---------------------------------	------------------------------

**WIDE SCRIBE**



**WSCRIBE 212**

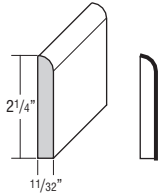

- One 8' section.

**Finish Techniques**

Distressing	Heirlooming
	•

**Species Availability (Wood)**

Alder	Rustic Alder	Cherry	Rustic Hickory	Maple	Oak
•	•	•	•	•	•

**Species Availability (All Laminates)**

High Gloss box color	Horiz. Grain on Maple box color	Vert. Grain on Maple box color	Vert. Grain on Cherry box color	Vert. Grain on Oak box color
----------------------	---------------------------------	--------------------------------	---------------------------------	------------------------------

**UNDER PANEL MOULDING**



**UPM8 155**

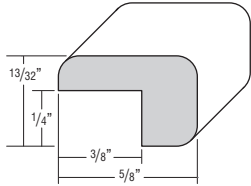

- One 8' section.
- Can be used on edges of 1/4" thick panels to conceal end grain.

**Finish Techniques**

Distressing	Heirlooming
	•

**Species Availability (Wood)**

Alder	Rustic Alder	Cherry	Rustic Hickory	Maple	Oak
•	•	•	•	•	•

**Species Availability (All Laminates)**

High Gloss box color	Horiz. Grain on Maple box color	Vert. Grain on Maple box color	Vert. Grain on Cherry box color	Vert. Grain on Oak box color
----------------------	---------------------------------	--------------------------------	---------------------------------	------------------------------

**UNDER PANEL MOULDING, PREMIUM**



**UPM8P 388**

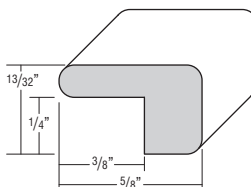

- One 8' section.
- Horizontal grain except on High Gloss.
- Can be used on edges of 1/4" thick panels to conceal end grain.

**Finish Techniques**

Distressing	Heirlooming
	•

**Species Availability (Wood)**

Alder	Rustic Alder	Cherry	Rustic Hickory	Maple	Oak
•	•	•	•	•	•

**Species Availability (All Laminates)**

High Gloss	Horiz. Grain on Maple	Vert. Grain on Maple	Vert. Grain on Cherry	Vert. Grain on Oak
	•	•	•	•

**DESCRIPTION MODEL PRICE**

**TOE MOULDING**

**BASEBOARD**



**BBM8 260**

**BBM10 ♦ 352**

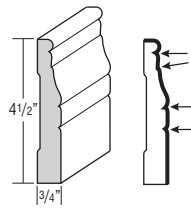

- BBM8 is one 8' section.
- BBM10 is one 10' section. 5 day Express Response not available.
- BBM8 can be used in place of standard toekick to provide a surface for glaze hang-up on premium finishes.

**Finish Techniques**

Distressing	Heirlooming
•	•

**Species Availability (Wood)**

Alder	Rustic Alder	Cherry	Rustic Hickory	Maple	Oak
•	•	•	•	•	•

♦ Only available in Cherry and Maple.

**Species Availability (All Laminates)**

High Gloss box color	Horiz. Grain on Maple box color	Vert. Grain on Maple box color	Vert. Grain on Cherry box color	Vert. Grain on Oak box color
----------------------	---------------------------------	--------------------------------	---------------------------------	------------------------------

♦ Only available in Cherry and Maple box colors.

**BASEBOARD - SCULPTED**



**BBMSC 281**

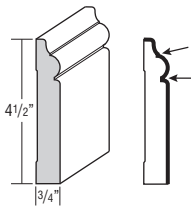

- One 8' section.
- BBMSC can be used in place of standard toekick to provide a surface for glaze hang-up on premium finishes.

**Finish Techniques**

Distressing	Heirlooming
	•

**Species Availability (Wood)**

Alder	Rustic Alder	Cherry	Rustic Hickory	Maple	Oak
•	•	•	•	•	•

**Species Availability (All Laminates)**

High Gloss box color	Horiz. Grain on Maple box color	Vert. Grain on Maple box color	Vert. Grain on Cherry box color	Vert. Grain on Oak box color
----------------------	---------------------------------	--------------------------------	---------------------------------	------------------------------

**BASEBOARD - SHAKER**



**BBMSH8 281**

**BBMSH10 ♦ 370**

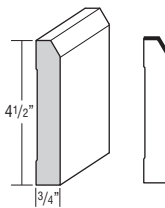

- BBMSH8 is one 8' section.
- BBMSH10 is one 10' section. 5 day Express Response not available.

**Finish Techniques**

Distressing	Heirlooming
•	•

**Species Availability (Wood)**

Alder	Rustic Alder	Cherry	Rustic Hickory	Maple	Oak
•	•	•	•	•	•

♦ Only available in Cherry and Maple.

**Species Availability (All Laminates)**

High Gloss box color	Horiz. Grain on Maple box color	Vert. Grain on Maple box color	Vert. Grain on Cherry box color	Vert. Grain on Oak box color
----------------------	---------------------------------	--------------------------------	---------------------------------	------------------------------

♦ Only available in Cherry and Maple box colors.

Finished edges indicated by bold lines on side view drawings.  
Glazed edges indicated by arrows on side view drawings.

**DESCRIPTION**

**MODEL**

**PRICE**

**BASEBOARD - SWOOPED**



**BBMSW**

281

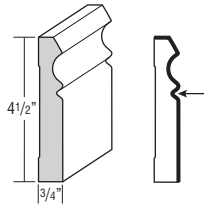

- One 8" section.
- BBMSW can be used in place of standard toekick to provide a surface for glaze hang-up on premium finishes.

**Finish Techniques**

Distressing	Heirlooming
	•

**Species Availability (Wood)**

Alder	Rustic Alder	Cherry	Rustic Hickory	Maple	Oak
•	•	•	•	•	•

**Species Availability (All Laminates)**

High Gloss	Horiz. Grain on Maple	Vert. Grain on Maple	Vert. Grain on Cherry	Vert. Grain on Oak
box color	box color	box color	box color	box color

**TOEBOARDS**



**TB8LAM18 ♦**

42

**TB8WD14**

115

**TB8LAM12 ♦**

50

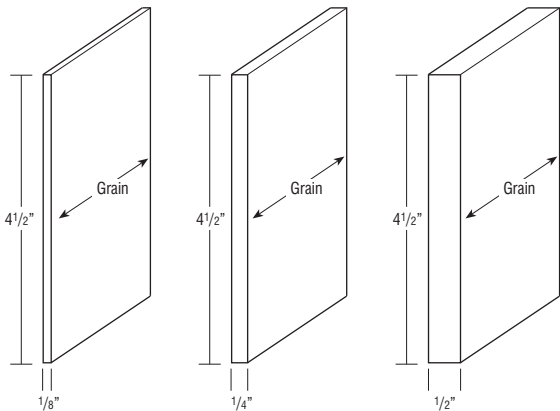

- TB8LAM18 is 1/8" laminated furniture board (White only).
- TB8WD14 in Stains: 1/4" thick veneered furniture board.
- TB8WD14 in Paints: 1/4" thick veneered or solid furniture board.
- TB8LAM12 is 1/2" laminated furniture board (White only).
- One 8" section.

**Finish Techniques**

Distressing	Heirlooming

**Species Availability (Wood)**

Alder	Rustic Alder	Cherry	Rustic Hickory	Maple	Oak
•	Alder	•	Hickory	•	•

♦ Only available in White Laminate.

**Species Availability (All Laminates)**

High Gloss	Horiz. Grain on Maple	Vert. Grain on Maple	Vert. Grain on Cherry	Vert. Grain on Oak
box color	box color	box color	box color	box color

♦ Only available in White laminate.

**DESCRIPTION**

**MODEL**

**PRICE**

**TOEBOARDS, PREMIUM**



**TB8P14**

231

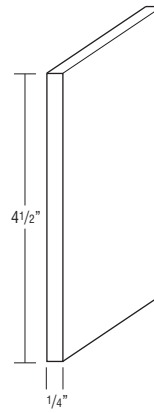

- 1/4" thick laminated MDF.
- One 8" section.
- Horizontal grain except on High Gloss.

**Finish Techniques**

Distressing	Heirlooming

**Species Availability (Wood)**

Alder	Rustic Alder	Cherry	Rustic Hickory	Maple	Oak

**Species Availability (All Laminates)**

High Gloss	Horiz. Grain on Maple	Vert. Grain on Maple	Vert. Grain on Cherry	Vert. Grain on Oak
•	•	•	•	•

**TOEKICK CAP**



**TKC**

32 /pair

- Sold in pairs.

**Finish Techniques**

Distressing	Heirlooming

**Species Availability (Wood)**

Alder	Rustic Alder	Cherry	Rustic Hickory	Maple	Oak
Maple	Maple	Maple	Oak	•	•

**Species Availability (All Laminates)**

High Gloss	Horiz. Grain on Maple	Vert. Grain on Maple	Vert. Grain on Cherry	Vert. Grain on Oak
box color	box color	box color	box color	box color

**WINDOW CASING**

**WINDOW CASING - TRADITIONAL**



**WCT8**

184

- One 8" section.

**Finish Techniques**

Distressing	Heirlooming
	•

**Species Availability (Wood)**

Alder	Rustic Alder	Cherry	Rustic Hickory	Maple	Oak
•	Alder	•	Hickory	•	•

**Species Availability (All Laminates)**

High Gloss	Horiz. Grain on Maple	Vert. Grain on Maple	Vert. Grain on Cherry	Vert. Grain on Oak
box color	box color	box color	box color	box color

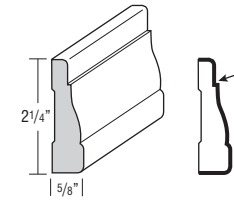

Finished edges indicated by bold lines on side view drawings.  
Glazed edges indicated by arrows on side view drawings.

**DESCRIPTION MODEL PRICE**  
**LIGHT RAILS**

**CAP MOULDING**



**CAPM**

**137**

- One 8' section.

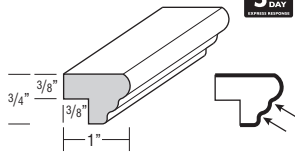

**Finish Techniques**

Distressing	Heirloom
•	•

**Species Availability (Wood)**

Alder	Rustic Alder	Cherry	Rustic Hickory	Maple	Oak
•	•	•	•	•	•

**Species Availability (All Laminates)**

High Gloss box color	Horiz. Grain on Maple box color	Vert. Grain on Maple box color	Vert. Grain on Cherry box color	Vert. Grain on Oak box color
•	•	•	•	•

**LIGHT BAFFLE**



**LB2**

**117**

- One 8' section.

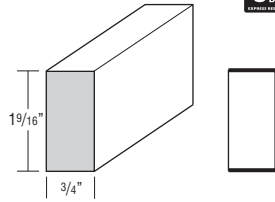

**Finish Techniques**

Distressing	Heirloom
•	•

**Species Availability (Wood)**

Alder	Rustic Alder	Cherry	Rustic Hickory	Maple	Oak
•	•	•	•	•	•

**Species Availability (All Laminates)**

High Gloss box color	Horiz. Grain on Maple box color	Vert. Grain on Maple box color	Vert. Grain on Cherry box color	Vert. Grain on Oak box color
•	•	•	•	•

**LIGHT BAFFLE, PREMIUM**



**LB2P**

**351**

- One 8' section.
- Horizontal grain except on High Gloss.

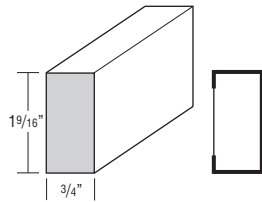

**Finish Techniques**

Distressing	Heirloom
•	•

**Species Availability (Wood)**

Alder	Rustic Alder	Cherry	Rustic Hickory	Maple	Oak
•	•	•	•	•	•

**Species Availability (All Laminates)**

High Gloss	Horiz. Grain on Maple	Vert. Grain on Maple	Vert. Grain on Cherry	Vert. Grain on Oak
•	•	•	•	•

**SMALL LIGHT RAIL MOULDING**



**SMLR**

**429**

- One 8' section.

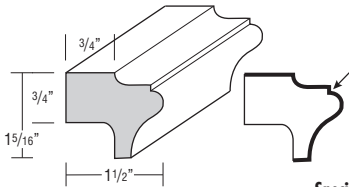

**Finish Techniques**

Distressing	Heirloom
•	•

**Species Availability (Wood)**

Alder	Rustic Alder	Cherry	Rustic Hickory	Maple	Oak
•	•	•	•	•	•

**Species Availability (All Laminates)**

High Gloss box color	Horiz. Grain on Maple box color	Vert. Grain on Maple box color	Vert. Grain on Cherry box color	Vert. Grain on Oak box color
•	•	•	•	•

**DESCRIPTION MODEL PRICE**  
**LIGHT RAIL MOULDING**



**LRM**

**492**

- One 8' section.

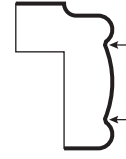
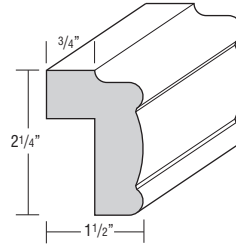

**Finish Techniques**

Distressing	Heirloom
•	•

**Species Availability (Wood)**

Alder	Rustic Alder	Cherry	Rustic Hickory	Maple	Oak
•	•	•	•	•	•

**Species Availability (All Laminates)**

High Gloss box color	Horiz. Grain on Maple box color	Vert. Grain on Maple box color	Vert. Grain on Cherry box color	Vert. Grain on Oak box color
•	•	•	•	•

**VALLEY FORGE**



**VFR8**

**112**

- Must be shimmed at shaded area if used with full overlay styles.
- One 8' section.

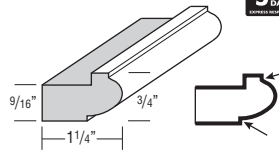

**Finish Techniques**

Distressing	Heirloom
•	•

**Species Availability (Wood)**

Alder	Rustic Alder	Cherry	Rustic Hickory	Maple	Oak
•	•	•	•	•	•

**Species Availability (All Laminates)**

High Gloss box color	Horiz. Grain on Maple box color	Vert. Grain on Maple box color	Vert. Grain on Cherry box color	Vert. Grain on Oak box color
•	•	•	•	•

**TRADITIONAL LIGHT RAIL**



**JINSERTLRT**

**731**

- One 8' section.
- Designed for use with all 3/4" insert mouldings.

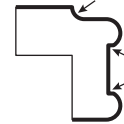
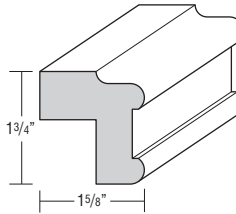

**Finish Techniques**

Distressing	Heirloom
•	•

**Species Availability (Wood)**

Alder	Rustic Alder	Cherry	Rustic Hickory	Maple	Oak
•	•	•	•	•	•

**Species Availability (All Laminates)**

High Gloss box color	Horiz. Grain on Maple box color	Vert. Grain on Maple box color	Vert. Grain on Cherry box color	Vert. Grain on Oak box color
•	•	•	•	•

**CONTEMPORARY LIGHT RAIL**



**JINSERTLRC**

**703**

- One 8' section.
- Designed for use with all 3/4" insert mouldings.

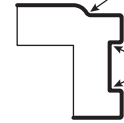
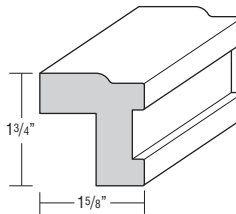

**Finish Techniques**

Distressing	Heirloom
•	•

**Species Availability (Wood)**

Alder	Rustic Alder	Cherry	Rustic Hickory	Maple	Oak
•	•	•	•	•	•

**Species Availability (All Laminates)**

High Gloss box color	Horiz. Grain on Maple box color	Vert. Grain on Maple box color	Vert. Grain on Cherry box color	Vert. Grain on Oak box color
•	•	•	•	•

Finished edges indicated by bold lines on side view drawings.  
 Glazed edges indicated by arrows on side view drawings.

**DESCRIPTION**  
**LIGHT RAIL INSERTS**

**MODEL**

**PRICE**

**ACANTHUS LIGHT RAIL INSERT**



**JLRINSACAN**

**1034**

- One 8" section.
- Pattern is 6" repeat.

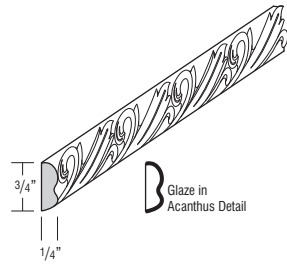

**Finish Techniques**

Distressing	Heirloom
	•

**Species Availability (Wood)**

Alder	Rustic Alder	Cherry	Rustic Hickory	Maple	Oak
•	Alder	•		•	

**Species Availability (All Laminates)**

High Gloss box color	Horiz. Grain on Maple box color	Vert. Grain on Maple box color	Vert. Grain on Cherry box color	Vert. Grain on Oak

**CELTIC LIGHT RAIL INSERT**



**JLRINSCFLT**

**682**

- One 8" section.
- Pattern is 6" repeat.

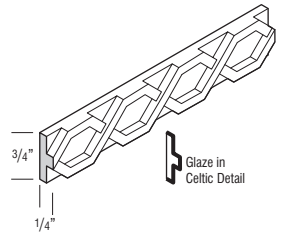

**Finish Techniques**

Distressing	Heirloom
	•

**Species Availability (Wood)**

Alder	Rustic Alder	Cherry	Rustic Hickory	Maple	Oak
•	Alder	•		•	

**Species Availability (All Laminates)**

High Gloss box color	Horiz. Grain on Maple box color	Vert. Grain on Maple box color	Vert. Grain on Cherry box color	Vert. Grain on Oak

**MISSION LIGHT RAIL INSERT**



**JLRINSMIS**

**1034**

- One 8" section.
- Pattern is 6" repeat.

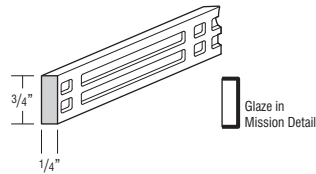

**Finish Techniques**

Distressing	Heirloom
	•

**Species Availability (Wood)**

Alder	Rustic Alder	Cherry	Rustic Hickory	Maple	Oak
•	Alder	•		•	

**Species Availability (All Laminates)**

High Gloss box color	Horiz. Grain on Maple box color	Vert. Grain on Maple box color	Vert. Grain on Cherry box color	Vert. Grain on Oak

**WEAVE LIGHT RAIL INSERT**



**JLRINSWEAVE**

**1034**

- One 8" section.
- Pattern is 6" repeat.

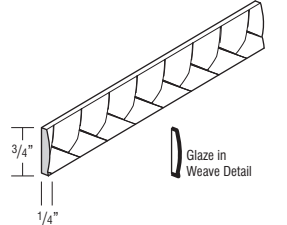

**Finish Techniques**

Distressing	Heirloom
	•

**Species Availability (Wood)**

Alder	Rustic Alder	Cherry	Rustic Hickory	Maple	Oak
•	Alder	•		•	

**Species Availability (All Laminates)**

High Gloss box color	Horiz. Grain on Maple box color	Vert. Grain on Maple box color	Vert. Grain on Cherry box color	Vert. Grain on Oak

**DESCRIPTION**  
**CORNER MOULDINGS**

**MODEL**

**PRICE**

**DIAGONAL CORNER**



**DCM8**

**181**

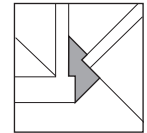
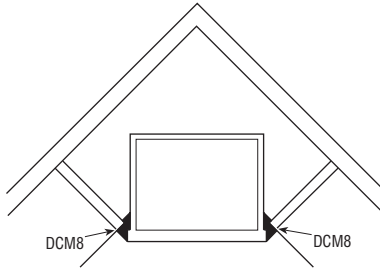
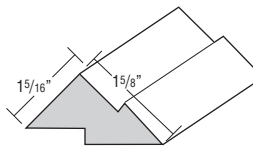

- Designed to set cabinets at a 45° corner application using 3/4" end panels.
- One 8" section.
- Not compatible on cabinets with Furniture Ends (FPEB) or Authentic Ends (AUTHL/AUTHR).

**Finish Techniques**

Distressing	Heirloom

**Species Availability (Wood)**

Alder	Rustic Alder	Cherry	Rustic Hickory	Maple	Oak
•	Alder	•	Hickory	•	•

**Species Availability (All Laminates)**

High Gloss box color	Horiz. Grain on Maple box color	Vert. Grain on Maple box color	Vert. Grain on Cherry box color	Vert. Grain on Oak box color

**INSIDE CORNER**



**ICM8**

**79**

- One 8" section.

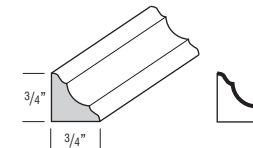

**Finish Techniques**

Distressing	Heirloom

**Species Availability (Wood)**

Alder	Rustic Alder	Cherry	Rustic Hickory	Maple	Oak
•	Alder				•

**Species Availability (All Laminates)**

High Gloss box color	Horiz. Grain on Maple box color	Vert. Grain on Maple box color	Vert. Grain on Cherry box color	Vert. Grain on Oak box color

**INSIDE CORNER, PREMIUM**



**ICM8P**

**236**

- One 8" section.
- Horizontal grain except on High Gloss.

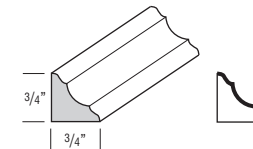

**Finish Techniques**

Distressing	Heirloom

**Species Availability (Wood)**

Alder	Rustic Alder	Cherry	Rustic Hickory	Maple	Oak

**Species Availability (All Laminates)**

High Gloss	Horiz. Grain on Maple	Vert. Grain on Maple	Vert. Grain on Cherry	Vert. Grain on Oak
•	•	•	•	•

Finished edges indicated by bold lines on side view drawings.  
Glazed edges indicated by arrows on side view drawings.



**DESCRIPTION MODEL PRICE**

**LARGE OUTSIDE CORNER**



**LOSC8**

121

- One 8' section.

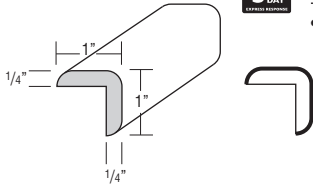

**Finish Techniques**

Distressing	Heirlooming
-------------	-------------

**Species Availability (Wood)**

Alder	Rustic Alder	Cherry	Rustic Hickory	Maple	Oak
•	Alder	•	Hickory	•	•

**Species Availability (All Laminates)**

High Gloss	Horiz. Grain on Maple	Vert. Grain on Maple	Vert. Grain on Cherry	Vert. Grain on Oak
box color	box color	box color	box color	box color

**OUTSIDE CORNER**



**OCM8**

72

- One 8' section.

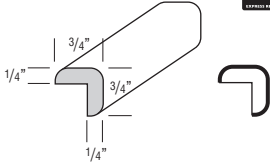

**Finish Techniques**

Distressing	Heirlooming
-------------	-------------

**Species Availability (Wood)**

Alder	Rustic Alder	Cherry	Rustic Hickory	Maple	Oak
•	Alder	•	Hickory	•	•

**Species Availability (All Laminates)**

High Gloss	Horiz. Grain on Maple	Vert. Grain on Maple	Vert. Grain on Cherry	Vert. Grain on Oak
box color	box color	box color	box color	box color

**OUTSIDE CORNER, PREMIUM**



**OCM8P**

216

- One 8' section.
- Horizontal grain except on High Gloss.

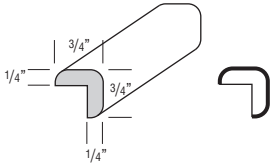

**Finish Techniques**

Distressing	Heirlooming
-------------	-------------

**Species Availability (Wood)**

Alder	Rustic Alder	Cherry	Rustic Hickory	Maple	Oak
•	Alder	•	Hickory	•	•

**Species Availability (All Laminates)**

High Gloss	Horiz. Grain on Maple	Vert. Grain on Maple	Vert. Grain on Cherry	Vert. Grain on Oak
•	•	•	•	•

**OUTSIDE CORNER 135°**



**OC135**

116

- One 8' section.

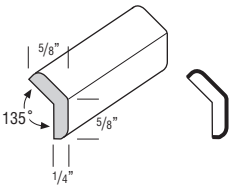

**Finish Techniques**

Distressing	Heirlooming
-------------	-------------

**Species Availability (Wood)**

Alder	Rustic Alder	Cherry	Rustic Hickory	Maple	Oak
•	Alder	•	Hickory	•	•

**Species Availability (All Laminates)**

High Gloss	Horiz. Grain on Maple	Vert. Grain on Maple	Vert. Grain on Cherry	Vert. Grain on Oak
box color	box color	box color	box color	box color

**DESCRIPTION MODEL PRICE**

**QUARTER ROUND MOULDING**



**QRM**

90

- One 8' section.

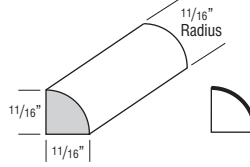

**Finish Techniques**

Distressing	Heirlooming
-------------	-------------

**Species Availability (Wood)**

Alder	Rustic Alder	Cherry	Rustic Hickory	Maple	Oak
•	Alder	•	Hickory	•	•

**Species Availability (All Laminates)**

High Gloss	Horiz. Grain on Maple	Vert. Grain on Maple	Vert. Grain on Cherry	Vert. Grain on Oak
box color	box color	box color	box color	box color

**SHOE - CONVEX INSIDE CORNER**



**SHM8**

69

- One 8' section.

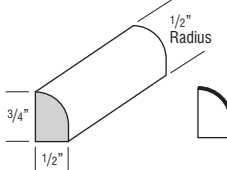

**Finish Techniques**

Distressing	Heirlooming
-------------	-------------

**Species Availability (Wood)**

Alder	Rustic Alder	Cherry	Rustic Hickory	Maple	Oak
•	Alder	•	Hickory	•	•

**Species Availability (All Laminates)**

High Gloss	Horiz. Grain on Maple	Vert. Grain on Maple	Vert. Grain on Cherry	Vert. Grain on Oak
box color	box color	box color	box color	box color

Finished edges indicated by bold lines on side view drawings.  
Glazed edges indicated by arrows on side view drawings.

**DESCRIPTION**

**MODEL**

**PRICE**

**VALANCES**

**ARCHED VALANCE**

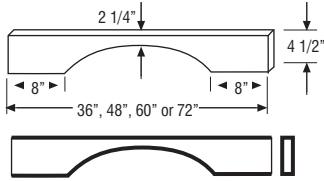

- Side shoulders are 8" wide (6" trimmable each end).
- Bottom edge has 3/16" radius.
- 3/4" thick.

**Finish Techniques**

Distressing	Heirlooming
•	•

**Species Availability (Wood)**

Alder	Rustic Alder	Cherry	Rustic Hickory	Maple	Oak
•	•	•	•	•	•

**Species Availability (All Laminates)**

High Gloss box color	Horiz. Grain on Maple box color	Vert. Grain on Maple box color	Vert. Grain on Cherry box color	Vert. Grain on Oak box color
----------------------	---------------------------------	--------------------------------	---------------------------------	------------------------------

**FURNITURE VALANCE**

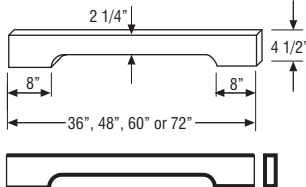

- Side shoulders are 8" wide (6" trimmable each end).
- Bottom edge has 3/16" radius profile on face.
- 3/4" thick.

**Finish Techniques**

Distressing	Heirlooming
•	•

**Species Availability (Wood)**

Alder	Rustic Alder	Cherry	Rustic Hickory	Maple	Oak
•	•	•	•	•	•

**Species Availability (All Laminates)**

High Gloss box color	Horiz. Grain on Maple box color	Vert. Grain on Maple box color	Vert. Grain on Cherry box color	Vert. Grain on Oak box color
----------------------	---------------------------------	--------------------------------	---------------------------------	------------------------------

**RAISED PANEL ARCH VALANCE**

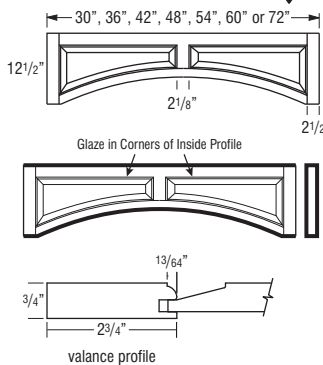

- Trimmable up to 1 3/4" per side.
- Recommended for use with hearths, see page 222.
- Center height 8".
- Raised panel profile is unique to this item and does not match any door style.
- Ends are pocket drilled for installation to adjacent cabinet frames.

**Finish Techniques**

Distressing	Heirlooming
•	•

**Species Availability (Wood)**

Alder	Rustic Alder	Cherry	Rustic Hickory	Maple	Oak
•	•	•	•	•	•

**Species Availability (All Laminates)**

High Gloss box color	Horiz. Grain on Maple box color	Vert. Grain on Maple box color	Vert. Grain on Cherry box color	Vert. Grain on Oak box color
----------------------	---------------------------------	--------------------------------	---------------------------------	------------------------------

**DESCRIPTION**

**MODEL**

**PRICE**

**RECESSED PANEL ARCH VALANCE**

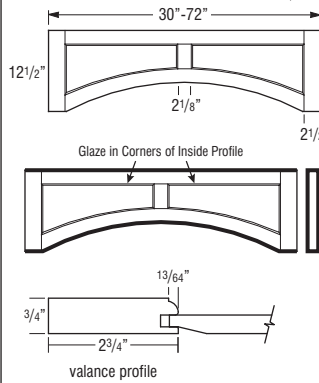

JRCPV30	1100
JRCPV36	1158
JRCPV42	1214
JRCPV48	1351
JRCPV54	1494
JRCPV60	1636
JRCPV72	1975

- Trimmable up to 1 3/4" per side.
- Recommended for use with hearths, see page 222.
- Center height 8".
- Ends are pocket drilled for installation to adjacent cabinet frames.

**Finish Techniques**

Distressing	Heirlooming
•	•

**Species Availability (Wood)**

Alder	Rustic Alder	Cherry	Rustic Hickory	Maple	Oak
•	•	•	•	•	•

**Species Availability (All Laminates)**

High Gloss box color	Horiz. Grain on Maple box color	Vert. Grain on Maple box color	Vert. Grain on Cherry box color	Vert. Grain on Oak box color
----------------------	---------------------------------	--------------------------------	---------------------------------	------------------------------

**SCALLOPED VALANCE**

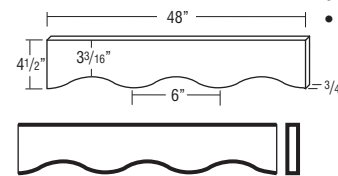

- Trimmable.
- 3/4" thick.

**Finish Techniques**

Distressing	Heirlooming
•	•

**Species Availability (Wood)**

Alder	Rustic Alder	Cherry	Rustic Hickory	Maple	Oak
•	• Alder	•	• Hickory	•	•

**Species Availability (All Laminates)**

High Gloss box color	Horiz. Grain on Maple box color	Vert. Grain on Maple box color	Vert. Grain on Cherry box color	Vert. Grain on Oak box color
----------------------	---------------------------------	--------------------------------	---------------------------------	------------------------------

**STRAIGHT VALANCE**

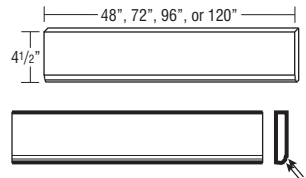

VV48	117
VV72	161
VV96	240
VV120 ♦	325

- Trimmable.
- 3/4" thick.

**Finish Techniques**

Distressing	Heirlooming
•	•

**Species Availability (Wood)**

Alder	Rustic Alder	Cherry	Rustic Hickory	Maple	Oak
•	•	•	•	•	•

♦ Only available in Cherry and Maple.

**Species Availability (All Laminates)**

High Gloss box color	Horiz. Grain on Maple box color	Vert. Grain on Maple box color	Vert. Grain on Cherry box color	Vert. Grain on Oak box color
----------------------	---------------------------------	--------------------------------	---------------------------------	------------------------------

♦ Only available in Cherry and Maple box colors.

Finished edges indicated by bold lines on side view drawings.  
Glazed edges indicated by arrows on side view drawings.

**DESCRIPTION MODEL PRICE**  
**DECORATIVE OVERLAYS**

**ACANTHUS OVERLAY** **ACOVLV** 1035

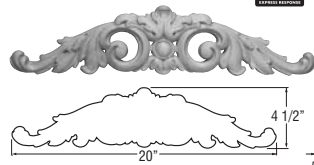

- Apply with small brad.
- Cannot be installed on valances.



**Finish Techniques**

Distressing	Heirlooming
	•

**Species Availability (Wood)**

Alder	Rustic Alder	Cherry	Rustic Hickory	Maple	Oak
•	Alder	•		•	

**Species Availability (All Laminates)**

High Gloss box color	Horiz. Grain on Maple box color	Vert. Grain on Maple box color	Vert. Grain on Cherry box color	Vert. Grain on Oak
----------------------	---------------------------------	--------------------------------	---------------------------------	--------------------

**DECORATIVE ORNAMENTS**

**ACANTHUS ORNAMENT** **ACO** 398

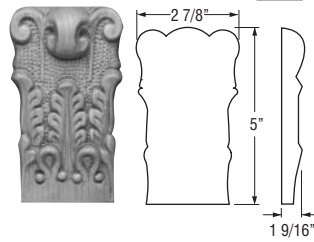

- Apply with small brad.



**Finish Techniques**

Distressing	Heirlooming
	•

**Species Availability (Wood)**

Alder	Rustic Alder	Cherry	Rustic Hickory	Maple	Oak
•	Alder	•		•	

**Species Availability (All Laminates)**

High Gloss box color	Horiz. Grain on Maple box color	Vert. Grain on Maple box color	Vert. Grain on Cherry box color	Vert. Grain on Oak
----------------------	---------------------------------	--------------------------------	---------------------------------	--------------------

**MISSION ROSETTE** **ROSETTEMIS** 306

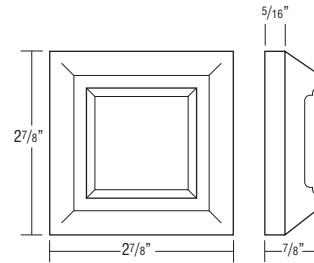

- Apply with small brad.

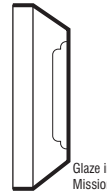

**Finish Techniques**

Distressing	Heirlooming
	•

**Species Availability (Wood)**

Alder	Rustic Alder	Cherry	Rustic Hickory	Maple	Oak
•	Alder	•		•	•

**Species Availability (All Laminates)**

High Gloss box color	Horiz. Grain on Maple box color	Vert. Grain on Maple box color	Vert. Grain on Cherry box color	Vert. Grain on Oak
----------------------	---------------------------------	--------------------------------	---------------------------------	--------------------

**DESCRIPTION MODEL PRICE**

**TRADITIONAL ROSETTE** **TROSETTE** 66

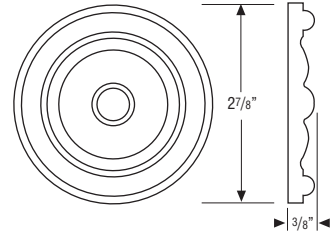

**Finish Techniques**

Distressing	Heirlooming
	•

**Species Availability (Wood)**

Alder	Rustic Alder	Cherry	Rustic Hickory	Maple	Oak
Cherry	Cherry	•	Beech	•	Beech

**Species Availability (All Laminates)**

High Gloss box color	Horiz. Grain on Maple box color	Vert. Grain on Maple box color	Vert. Grain on Cherry box color	Vert. Grain on Oak
----------------------	---------------------------------	--------------------------------	---------------------------------	--------------------

**CORNER ROSETTE, 3"** **FFRC3X3 (Fluted)** 97

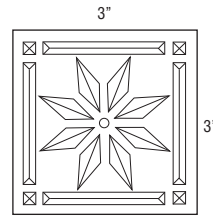

**Back Views of Rosette**

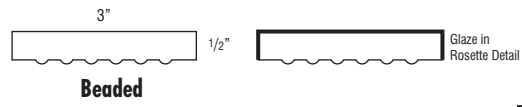
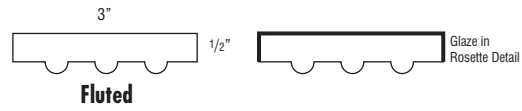

**Finish Techniques**

Distressing	Heirlooming

**Species Availability (Wood)**

Alder	Rustic Alder	Cherry	Rustic Hickory	Maple	Oak
•	Alder	•	Hickory	•	•

**Species Availability (All Laminates)**

High Gloss box color	Horiz. Grain on Maple box color	Vert. Grain on Maple box color	Vert. Grain on Cherry box color	Vert. Grain on Oak
----------------------	---------------------------------	--------------------------------	---------------------------------	--------------------

Finished edges indicated by bold lines on side view drawings.  
Glazed edges indicated by arrows on side view drawings.

**DESCRIPTION MODEL PRICE**

**CELTIC ROSETTE**



**ROSETTCEL**

**153**

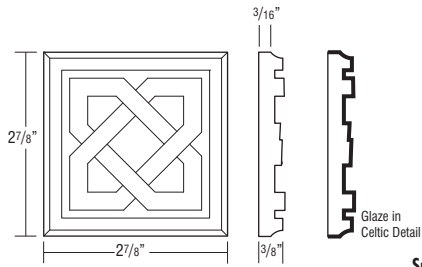

**Finish Techniques**

Distressing	Heirloom
	•

**Species Availability (Wood)**

Alder	Rustic Alder	Cherry	Rustic Hickory	Maple	Oak
•		•		•	•

**Species Availability (All Laminates)**

High Gloss box color	Horiz. Grain on Maple box color	Vert. Grain on Maple box color	Vert. Grain on Cherry box color	Vert. Grain on Oak box color
----------------------	---------------------------------	--------------------------------	---------------------------------	------------------------------

**PLINTH BLOCK FILLER, 3"**



**FFP3X8 (Fluted)**

**113**

**BFP3X8 (Beaded)**

**113**

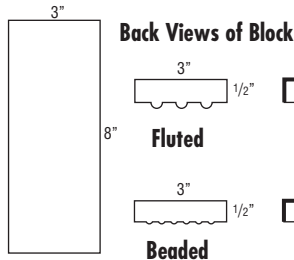

**Back Views of Block**



**Fluted**

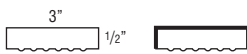

**Beaded**

**Finish Techniques**

Distressing	Heirloom
	•

**Species Availability (Wood)**

Alder	Rustic Alder	Cherry	Rustic Hickory	Maple	Oak
•	Alder	•		•	•

**Species Availability (All Laminates)**

High Gloss box color	Horiz. Grain on Maple box color	Vert. Grain on Maple box color	Vert. Grain on Cherry box color	Vert. Grain on Oak box color
----------------------	---------------------------------	--------------------------------	---------------------------------	------------------------------

**PLINTH BLOCK FILLER, 6"**



**FFP6X8 (Fluted)**

**133**

• Available only as fluted.

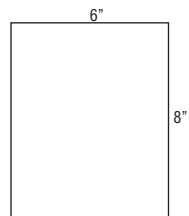

**Back View of Block**

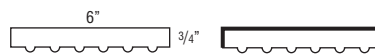

**Finish Techniques**

Distressing	Heirloom
	•

**Species Availability (Wood)**

Alder	Rustic Alder	Cherry	Rustic Hickory	Maple	Oak
•	Alder	•		•	•

**Species Availability (All Laminates)**

High Gloss box color	Horiz. Grain on Maple box color	Vert. Grain on Maple box color	Vert. Grain on Cherry box color	Vert. Grain on Oak box color
----------------------	---------------------------------	--------------------------------	---------------------------------	------------------------------

**DESCRIPTION MODEL PRICE**

**DECORATIVE SUPPORTS**

**BAROQUE LEG, 34 1/2" HIGH**



**JBAROQUELEG**

**1175**

- Trimtable.
- Leg is designed with three pieces. Field assembly required.

**Finish Techniques**

Distressing	Heirloom
	•

**Species Availability (Wood)**

Alder	Rustic Alder	Cherry	Rustic Hickory	Maple	Oak
•	Alder	•		•	

**Species Availability (All Laminates)**

High Gloss box color	Horiz. Grain on Maple box color	Vert. Grain on Maple box color	Vert. Grain on Cherry box color	Vert. Grain on Oak box color
----------------------	---------------------------------	--------------------------------	---------------------------------	------------------------------

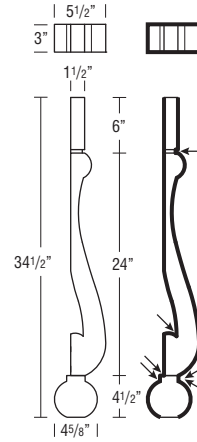

**BUFFET LEG, 34 1/2" HIGH**



**JBUFFETLEG**

**682**

- Trimtable.

**Finish Techniques**

Distressing	Heirloom
	•

**Species Availability (Wood)**

Alder	Rustic Alder	Cherry	Rustic Hickory	Maple	Oak
•	Alder	•		•	•

**Species Availability (All Laminates)**

High Gloss box color	Horiz. Grain on Maple box color	Vert. Grain on Maple box color	Vert. Grain on Cherry box color	Vert. Grain on Oak box color
----------------------	---------------------------------	--------------------------------	---------------------------------	------------------------------

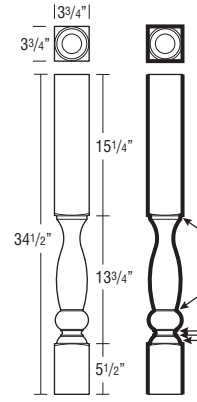

**NEW BUNGALOW LEG, 3" WIDE, 34 1/2" HIGH**



**BUNLEG3**

**975**

- Trimtable.

**Finish Techniques**

Distressing	Heirloom
	•

**Species Availability (Wood)**

Alder	Rustic Alder	Cherry	Rustic Hickory	Maple	Oak
•	Alder	•		•	•

**Species Availability (All Laminates)**

High Gloss box color	Horiz. Grain on Maple box color	Vert. Grain on Maple box color	Vert. Grain on Cherry box color	Vert. Grain on Oak box color
----------------------	---------------------------------	--------------------------------	---------------------------------	------------------------------

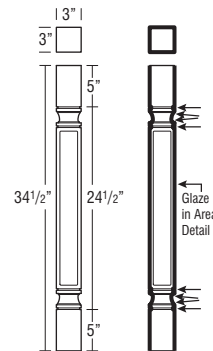

Finished edges indicated by bold lines on side view drawings.  
Glazed edges indicated by arrows on side view drawings.

**DESCRIPTION MODEL PRICE**

**NEW** BUNGALOW LEG,  
5" WIDE,  
34 1/2" HIGH



**BUNLEGS 1750**

- Trimmable.

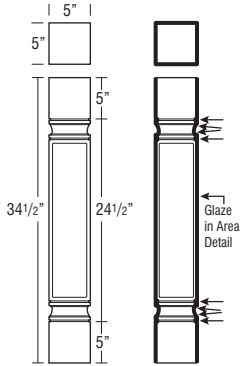

**Finish Techniques**

Distressing	Heirlooming
	•

**Species Availability (Wood)**

Alder	Rustic Alder	Cherry	Rustic Hickory	Maple	Oak
•	•	•		•	•

**Species Availability (All Laminates)**

High Gloss box color	Horiz. Grain on Maple box color	Vert. Grain on Maple box color	Vert. Grain on Cherry box color	Vert. Grain on Oak box color
-------------------------	---------------------------------------	--------------------------------------	---------------------------------------	------------------------------------

**DESCRIPTION MODEL PRICE**

ENGLISH BAR COLUMN,  
42 1/4" HIGH



**ENGBARCOLUMN 1204**

- Trimmable.

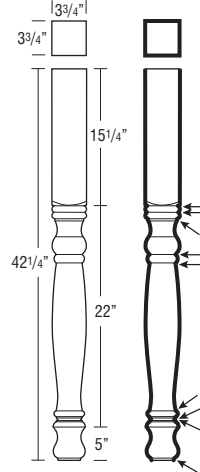

**Finish Techniques**

Distressing	Heirlooming
	•

**Species Availability (Wood)**

Alder	Rustic Alder	Cherry	Rustic Hickory	Maple	Oak
•	•	•		•	•

**Species Availability (All Laminates)**

High Gloss box color	Horiz. Grain on Maple box color	Vert. Grain on Maple box color	Vert. Grain on Cherry box color	Vert. Grain on Oak box color
-------------------------	---------------------------------------	--------------------------------------	---------------------------------------	------------------------------------

**COSMO LEG,  
35 1/4" HIGH**



**JCOSMOLEG 809**

- Trimmable.
- Leg is designed with three pieces joined together.

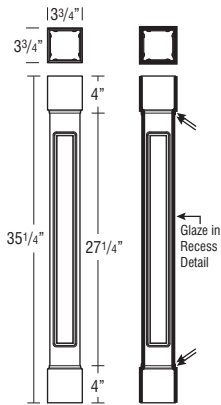

**Finish Techniques**

Distressing	Heirlooming
	•

**Species Availability (Wood)**

Alder	Rustic Alder	Cherry	Rustic Hickory	Maple	Oak
•	•	•		•	•

**Species Availability (All Laminates)**

High Gloss box color	Horiz. Grain on Maple box color	Vert. Grain on Maple box color	Vert. Grain on Cherry box color	Vert. Grain on Oak box color
-------------------------	---------------------------------------	--------------------------------------	---------------------------------------	------------------------------------

ENGLISH ISLAND COLUMN,  
5" WIDE, 35 1/4" HIGH



**ENGLISCOLUMN 1353**

- Trimmable.

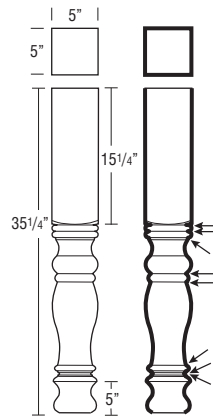

**Finish Techniques**

Distressing	Heirlooming
	•

**Species Availability (Wood)**

Alder	Rustic Alder	Cherry	Rustic Hickory	Maple	Oak
•	•	•		•	•

**Species Availability (All Laminates)**

High Gloss box color	Horiz. Grain on Maple box color	Vert. Grain on Maple box color	Vert. Grain on Cherry box color	Vert. Grain on Oak box color
-------------------------	---------------------------------------	--------------------------------------	---------------------------------------	------------------------------------

ENGLISH COUNTRY  
LEG, 35 1/4" HIGH



**JENGNTYLEG 787**

- Trimmable.

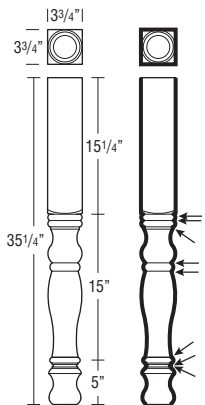

**Finish Techniques**

Distressing	Heirlooming
	•

**Species Availability (Wood)**

Alder	Rustic Alder	Cherry	Rustic Hickory	Maple	Oak
•	•	•		•	•

**Species Availability (All Laminates)**

High Gloss box color	Horiz. Grain on Maple box color	Vert. Grain on Maple box color	Vert. Grain on Cherry box color	Vert. Grain on Oak box color
-------------------------	---------------------------------------	--------------------------------------	---------------------------------------	------------------------------------

ESTATE LEG, SMALL,  
2 3/4" WIDE,  
35 1/4" HIGH



**JESTATELEGS 753**

- Trimmable.

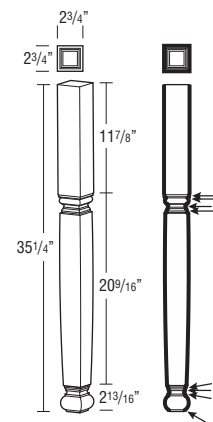

**Finish Techniques**

Distressing	Heirlooming
	•

**Species Availability (Wood)**

Alder	Rustic Alder	Cherry	Rustic Hickory	Maple	Oak
•	•	•		•	•

**Species Availability (All Laminates)**

High Gloss box color	Horiz. Grain on Maple box color	Vert. Grain on Maple box color	Vert. Grain on Cherry box color	Vert. Grain on Oak box color
-------------------------	---------------------------------------	--------------------------------------	---------------------------------------	------------------------------------

Finished edges indicated by bold lines on side view drawings.  
Glazed edges indicated by arrows on side view drawings.

**DESCRIPTION**

**MODEL**

**PRICE**

**ESTATE LEG SPLIT,  
SMALL, 2 3/4" WIDE,  
35 1/4" HIGH**



**JESTATELEGSS**

**528**

- Trimtable.

**Finish Techniques**

Distressing	Heirlooming
	•

**Species Availability (Wood)**

Alder	Rustic Alder	Cherry	Rustic Hickory	Maple	Oak
•	Alder	•		•	•

**Species Availability (All Laminates)**

High Glass box color	Horiz. Grain on Maple box color	Vert. Grain on Maple box color	Vert. Grain on Cherry box color	Vert. Grain on Oak box color
----------------------	---------------------------------	--------------------------------	---------------------------------	------------------------------

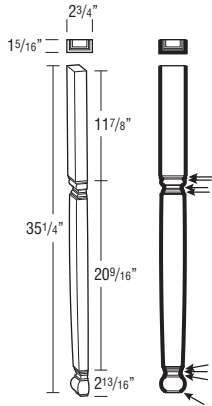

**DESCRIPTION**

**MODEL**

**PRICE**

**FLUTED LEG SPLIT,  
SMALL, 2 3/4" WIDE,  
35 1/4" HIGH**



**JFLUTELEGSS**

**546**

- Trimtable.

**Finish Techniques**

Distressing	Heirlooming
	•

**Species Availability (Wood)**

Alder	Rustic Alder	Cherry	Rustic Hickory	Maple	Oak
•	Alder	•		•	•

**Species Availability (All Laminates)**

High Glass box color	Horiz. Grain on Maple box color	Vert. Grain on Maple box color	Vert. Grain on Cherry box color	Vert. Grain on Oak box color
----------------------	---------------------------------	--------------------------------	---------------------------------	------------------------------

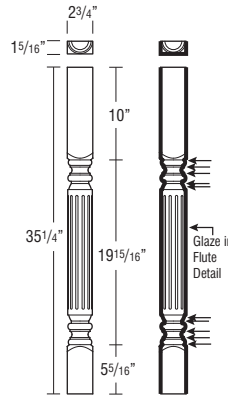

**ESTATE LEG,  
35 1/4" HIGH**



**JESTATELEG**

**837**

- Trimtable.

**Finish Techniques**

Distressing	Heirlooming
	•

**Species Availability (Wood)**

Alder	Rustic Alder	Cherry	Rustic Hickory	Maple	Oak
•	Alder	•		•	•

**Species Availability (All Laminates)**

High Glass box color	Horiz. Grain on Maple box color	Vert. Grain on Maple box color	Vert. Grain on Cherry box color	Vert. Grain on Oak box color
----------------------	---------------------------------	--------------------------------	---------------------------------	------------------------------

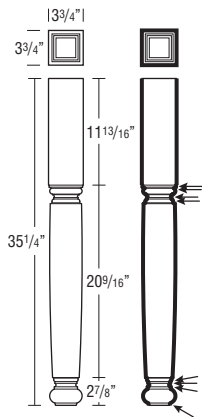

**FRENCH COUNTRY LEG,  
3 3/4" WIDE,  
35 1/4" HIGH**



**JFRNCNTYLEG**

**844**

- Trimtable.

**Finish Techniques**

Distressing	Heirlooming
	•

**Species Availability (Wood)**

Alder	Rustic Alder	Cherry	Rustic Hickory	Maple	Oak
•	Alder	•		•	•

**Species Availability (All Laminates)**

High Glass box color	Horiz. Grain on Maple box color	Vert. Grain on Maple box color	Vert. Grain on Cherry box color	Vert. Grain on Oak box color
----------------------	---------------------------------	--------------------------------	---------------------------------	------------------------------

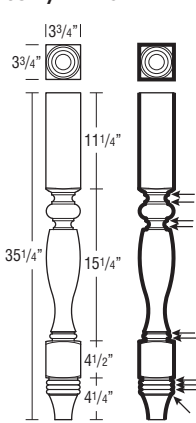

**FLUTED LEG, SMALL,  
2 3/4" WIDE,  
35 1/4" HIGH**



**JFLUTELEGS**

**780**

- Trimtable.

**Finish Techniques**

Distressing	Heirlooming
	•

**Species Availability (Wood)**

Alder	Rustic Alder	Cherry	Rustic Hickory	Maple	Oak
•	Alder	•		•	•

**Species Availability (All Laminates)**

High Glass box color	Horiz. Grain on Maple box color	Vert. Grain on Maple box color	Vert. Grain on Cherry box color	Vert. Grain on Oak box color
----------------------	---------------------------------	--------------------------------	---------------------------------	------------------------------

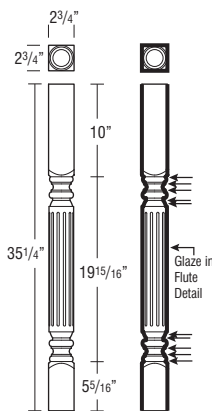

**FRENCH COUNTRY LEG,  
5" WIDE, 35 1/4" HIGH**



**JFRNCNTYLEGL**

**1201**

- Trimtable.

**Finish Techniques**

Distressing	Heirlooming
	•

**Species Availability (Wood)**

Alder	Rustic Alder	Cherry	Rustic Hickory	Maple	Oak
•	Alder	•		•	•

**Species Availability (All Laminates)**

High Glass box color	Horiz. Grain on Maple box color	Vert. Grain on Maple box color	Vert. Grain on Cherry box color	Vert. Grain on Oak box color
----------------------	---------------------------------	--------------------------------	---------------------------------	------------------------------

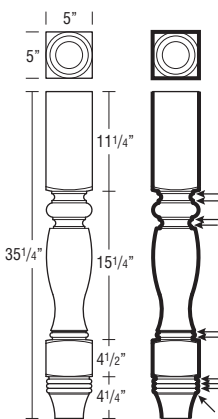

Finished edges indicated by bold lines on side view drawings.  
Glazed edges indicated by arrows on side view drawings.

**DESCRIPTION MODEL PRICE**

**NEW** GAELIC LEG,  
4 1/2" WIDE,  
35 1/2" HIGH



**GAELICLEG 1425**

- Trimtable.

**Finish Techniques**

Distressing	Heirlooming
	•

**Species Availability (Wood)**

Alder	Rustic Alder	Cherry	Rustic Hickory	Maple	Oak
•	Alder	•		•	•

**Species Availability (All Laminates)**

High Gloss box color	Horiz. Grain on Maple box color	Vert. Grain on Maple box color	Vert. Grain on Cherry box color	Vert. Grain on Oak box color
----------------------	---------------------------------	--------------------------------	---------------------------------	------------------------------

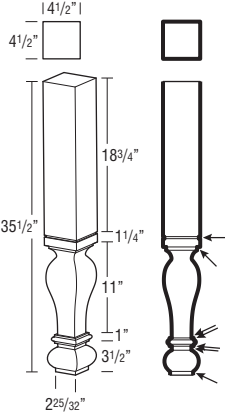

**ISLAND LEG, 2-SIDED,  
35 1/4" HIGH**



**2SISLLEG 980**

- Trimtable.

**Finish Techniques**

Distressing	Heirlooming
	•

**Species Availability (Wood)**

Alder	Rustic Alder	Cherry	Rustic Hickory	Maple	Oak
•	Alder	•		•	•

**Species Availability (All Laminates)**

High Gloss box color	Horiz. Grain on Maple box color	Vert. Grain on Maple box color	Vert. Grain on Cherry box color	Vert. Grain on Oak box color
----------------------	---------------------------------	--------------------------------	---------------------------------	------------------------------

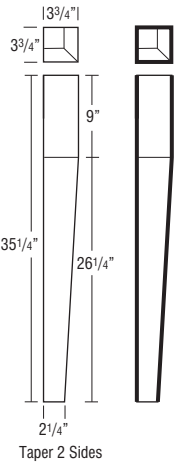

**ISLAND LEG, 4-SIDED,  
35 1/4" HIGH**



**4SISLLEG 1102**

- Trimtable.

**Finish Techniques**

Distressing	Heirlooming
	•

**Species Availability (Wood)**

Alder	Rustic Alder	Cherry	Rustic Hickory	Maple	Oak
•	Alder	•		•	•

**Species Availability (All Laminates)**

High Gloss box color	Horiz. Grain on Maple box color	Vert. Grain on Maple box color	Vert. Grain on Cherry box color	Vert. Grain on Oak box color
----------------------	---------------------------------	--------------------------------	---------------------------------	------------------------------

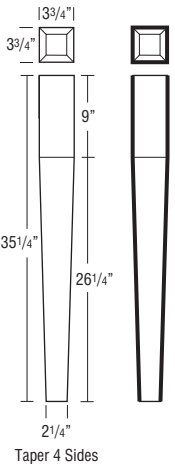

**DESCRIPTION MODEL PRICE**

**NEW** ISLAND LEG  
TAPERED,  
35 1/4" HIGH



**ISLEGTPRD 1325**

- Trimtable.

**Finish Techniques**

Distressing	Heirlooming
	•

**Species Availability (Wood)**

Alder	Rustic Alder	Cherry	Rustic Hickory	Maple	Oak
•	Alder	•		•	•

**Species Availability (All Laminates)**

High Gloss box color	Horiz. Grain on Maple box color	Vert. Grain on Maple box color	Vert. Grain on Cherry box color	Vert. Grain on Oak box color
----------------------	---------------------------------	--------------------------------	---------------------------------	------------------------------

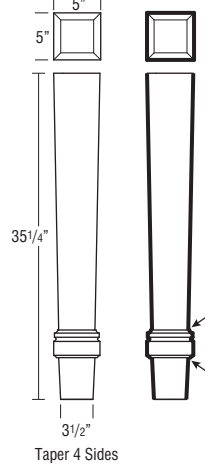

**METRO BAR COLUMN,  
42 1/4" HIGH**



**METBARCOLUMN 1192**

- Trimtable.

**Finish Techniques**

Distressing	Heirlooming
	•

**Species Availability (Wood)**

Alder	Rustic Alder	Cherry	Rustic Hickory	Maple	Oak
•	Alder	•		•	•

**Species Availability (All Laminates)**

High Gloss box color	Horiz. Grain on Maple box color	Vert. Grain on Maple box color	Vert. Grain on Cherry box color	Vert. Grain on Oak box color
----------------------	---------------------------------	--------------------------------	---------------------------------	------------------------------

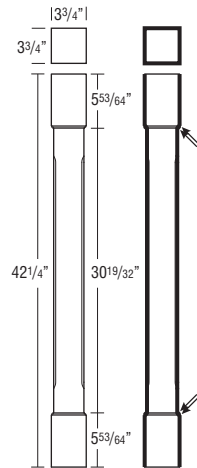

**METRO ISLAND COLUMN,  
34 5/8" HIGH**



**METISLCOLUMN 1092**

- Trimtable.

- Leg is designed with three pieces joined together.

**Finish Techniques**

Distressing	Heirlooming
	•

**Species Availability (Wood)**

Alder	Rustic Alder	Cherry	Rustic Hickory	Maple	Oak
•	Alder	•		•	•

**Species Availability (All Laminates)**

High Gloss box color	Horiz. Grain on Maple box color	Vert. Grain on Maple box color	Vert. Grain on Cherry box color	Vert. Grain on Oak box color
----------------------	---------------------------------	--------------------------------	---------------------------------	------------------------------

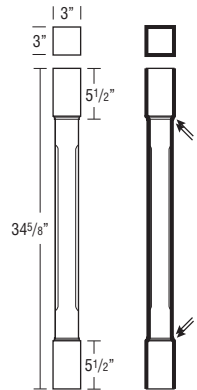

Finished edges indicated by bold lines on side view drawings.  
Glazed edges indicated by arrows on side view drawings.

**DESCRIPTION**

**MODEL**

**PRICE**

**MISSION LEG,  
34 1/2" HIGH**



**DLEGMISION**

981

- Trimmable.

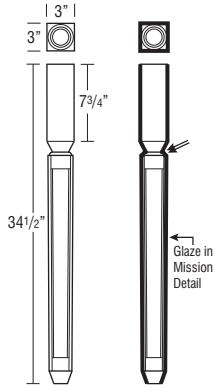

**Finish Techniques**

Distressing	Heirloom
	•

**Species Availability (Wood)**

Alder	Rustic Alder	Cherry	Rustic Hickory	Maple	Oak
•	Alder	•		•	•

**Species Availability (All Laminates)**

High Gloss box color	Horiz. Grain on Maple box color	Vert. Grain on Maple box color	Vert. Grain on Cherry box color	Vert. Grain on Oak box color
----------------------	---------------------------------	--------------------------------	---------------------------------	------------------------------

**DESCRIPTION**

**MODEL**

**PRICE**

**SPOOL LEG SPLIT,  
SMALL, 2 3/4" WIDE,  
35 1/4" HIGH**



**JSPLEGSS**

618

- Trimmable.

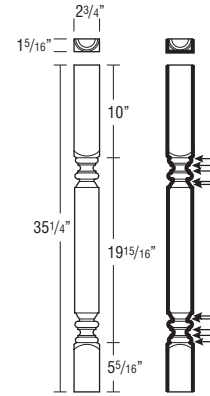

**Finish Techniques**

Distressing	Heirloom
	•

**Species Availability (Wood)**

Alder	Rustic Alder	Cherry	Rustic Hickory	Maple	Oak
•	Alder	•		•	•

**Species Availability (All Laminates)**

High Gloss box color	Horiz. Grain on Maple box color	Vert. Grain on Maple box color	Vert. Grain on Cherry box color	Vert. Grain on Oak box color
----------------------	---------------------------------	--------------------------------	---------------------------------	------------------------------

**ROPE LEG,  
3 3/4" WIDE,  
35 1/4" HIGH**



**JROPELEG**

878

- Trimmable.

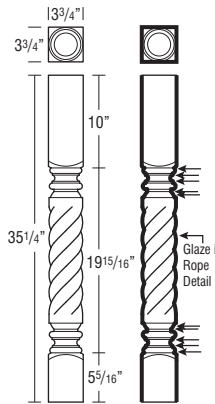

**Finish Techniques**

Distressing	Heirloom
	•

**Species Availability (Wood)**

Alder	Rustic Alder	Cherry	Rustic Hickory	Maple	Oak
•	Alder	•		•	•

**Species Availability (All Laminates)**

High Gloss box color	Horiz. Grain on Maple box color	Vert. Grain on Maple box color	Vert. Grain on Cherry box color	Vert. Grain on Oak box color
----------------------	---------------------------------	--------------------------------	---------------------------------	------------------------------

**SPOOL LEG,  
34 1/2" HIGH**



**SPLEG**

981

- Trimmable.

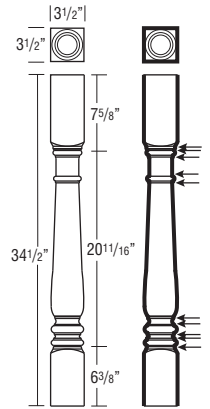

**Finish Techniques**

Distressing	Heirloom
	•

**Species Availability (Wood)**

Alder	Rustic Alder	Cherry	Rustic Hickory	Maple	Oak
•	Alder	•		•	•

**Species Availability (All Laminates)**

High Gloss box color	Horiz. Grain on Maple box color	Vert. Grain on Maple box color	Vert. Grain on Cherry box color	Vert. Grain on Oak box color
----------------------	---------------------------------	--------------------------------	---------------------------------	------------------------------

**ROPE LEG,  
5" WIDE, 35 1/4" HIGH**



**JROPELEGL**

1379

- Trimmable.

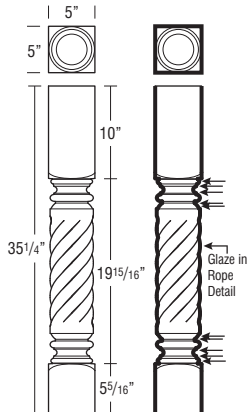

**Finish Techniques**

Distressing	Heirloom
	•

**Species Availability (Wood)**

Alder	Rustic Alder	Cherry	Rustic Hickory	Maple	Oak
•	Alder	•		•	•

**Species Availability (All Laminates)**

High Gloss box color	Horiz. Grain on Maple box color	Vert. Grain on Maple box color	Vert. Grain on Cherry box color	Vert. Grain on Oak box color
----------------------	---------------------------------	--------------------------------	---------------------------------	------------------------------

**SQUARE ISLAND LEG,  
3" x 3", 35 1/4" HIGH**



**JSQISLEG3**

678

- Trimmable.

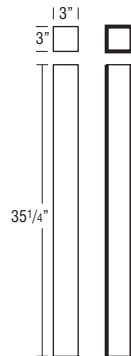

**Finish Techniques**

Distressing	Heirloom
	•

**Species Availability (Wood)**

Alder	Rustic Alder	Cherry	Rustic Hickory	Maple	Oak
•	Alder	•		•	•

**Species Availability (All Laminates)**

High Gloss box color	Horiz. Grain on Maple box color	Vert. Grain on Maple box color	Vert. Grain on Cherry box color	Vert. Grain on Oak box color
----------------------	---------------------------------	--------------------------------	---------------------------------	------------------------------

Finished edges indicated by bold lines on side view drawings.  
Glazed edges indicated by arrows on side view drawings.



**DESCRIPTION MODEL PRICE**

**SQUARE ISLAND LEG,  
4" x 4", 35 1/4" HIGH**



**JSQISLEG4 783**

- Trimmable.

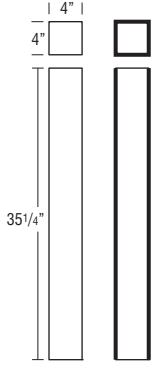

**Finish Techniques**

Distressing	Heirloom
	•

**Species Availability (Wood)**

Alder	Rustic Alder	Cherry	Rustic Hickory	Maple	Oak
•	Alder	•		•	•

**Species Availability (All Laminates)**

High Gloss box color	Horiz. Grain on Maple box color	Vert. Grain on Maple box color	Vert. Grain on Cherry box color	Vert. Grain on Oak box color
-------------------------	---------------------------------------	--------------------------------------	---------------------------------------	------------------------------------

**DESCRIPTION MODEL PRICE**

**SQUARE BAR LEG,  
6" x 6", 42 1/4" HIGH**



**JSQBARLEG6 1222**

- Trimmable.

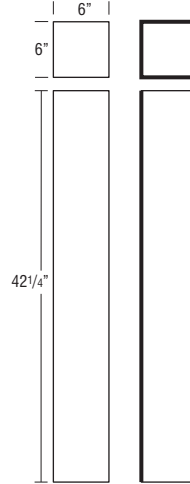

**Finish Techniques**

Distressing	Heirloom
	•

**Species Availability (Wood)**

Alder	Rustic Alder	Cherry	Rustic Hickory	Maple	Oak
•	Alder	•		•	•

**Species Availability (All Laminates)**

High Gloss box color	Horiz. Grain on Maple box color	Vert. Grain on Maple box color	Vert. Grain on Cherry box color	Vert. Grain on Oak box color
-------------------------	---------------------------------------	--------------------------------------	---------------------------------------	------------------------------------

**SQUARE ISLAND LEG,  
6" x 6", 35 1/4" HIGH**



**JSQISLEG6 1059**

- Trimmable.

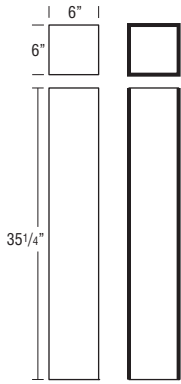

**Finish Techniques**

Distressing	Heirloom
	•

**Species Availability (Wood)**

Alder	Rustic Alder	Cherry	Rustic Hickory	Maple	Oak
•	Alder	•		•	•

**Species Availability (All Laminates)**

High Gloss box color	Horiz. Grain on Maple box color	Vert. Grain on Maple box color	Vert. Grain on Cherry box color	Vert. Grain on Oak box color
-------------------------	---------------------------------------	--------------------------------------	---------------------------------------	------------------------------------

**NEW SQUARE ISLAND LEG, METAL SLEEVE,  
3" x 3",  
35 1/4" HIGH**



**3SQLEGALS-35 585**

**3SQLEGWIS-35 585**

- Trimmable from top of leg.
- Finishes available: Brushed Aluminum Sleeve (ALS) and Wrought Iron Sleeve (WIS).
- Constructed of three 1" solid-wood sections.

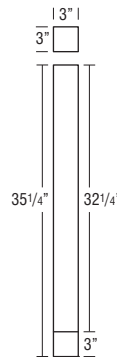

**Finish Techniques**

Distressing	Heirloom
	•

**Species Availability (Wood)**

Alder	Rustic Alder	Cherry	Rustic Hickory	Maple	Oak
•	Alder	•		•	•

**Species Availability (All Laminates)**

High Gloss box color	Horiz. Grain on Maple box color	Vert. Grain on Maple box color	Vert. Grain on Cherry box color	Vert. Grain on Oak box color
-------------------------	---------------------------------------	--------------------------------------	---------------------------------------	------------------------------------

**SQUARE BAR LEG,  
4" x 4", 42 1/4" HIGH**



**JSQBARLEG4 883**

- Trimmable.

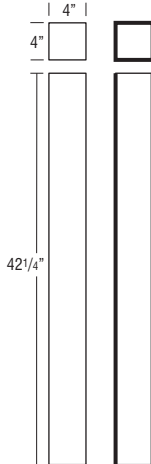

**Finish Techniques**

Distressing	Heirloom
	•

**Species Availability (Wood)**

Alder	Rustic Alder	Cherry	Rustic Hickory	Maple	Oak
•	Alder	•		•	•

**Species Availability (All Laminates)**

High Gloss box color	Horiz. Grain on Maple box color	Vert. Grain on Maple box color	Vert. Grain on Cherry box color	Vert. Grain on Oak box color
-------------------------	---------------------------------------	--------------------------------------	---------------------------------------	------------------------------------

**NEW SQUARE ISLAND LEG, METAL SLEEVE,  
4" x 4",  
35 1/4" HIGH**



**4SQLEGALS-35 750**

**4SQLEGWIS-35 750**

- Trimmable from top of leg.
- Finishes available: Brushed Aluminum Sleeve (ALS) and Wrought Iron Sleeve (WIS).
- Constructed of four 1" solid-wood sections.

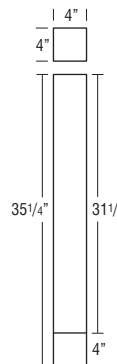

**Finish Techniques**

Distressing	Heirloom
	•

**Species Availability (Wood)**

Alder	Rustic Alder	Cherry	Rustic Hickory	Maple	Oak
•	Alder	•		•	•

**Species Availability (All Laminates)**

High Gloss box color	Horiz. Grain on Maple box color	Vert. Grain on Maple box color	Vert. Grain on Cherry box color	Vert. Grain on Oak box color
-------------------------	---------------------------------------	--------------------------------------	---------------------------------------	------------------------------------

Finished edges indicated by bold lines on side view drawings.  
Glazed edges indicated by arrows on side view drawings.

**DESCRIPTION**

**MODEL**

**PRICE**

**NEW** **SQUARE ISLAND LEG, METAL SLEEVE, 5" x 5", 35 1/4" HIGH**



**5SQLEGALS-35**  
**5SQLEGWIS-35**

1025  
1025

- Trimmable from top of leg.
- Finishes available: Brushed Aluminum Sleeve (ALS) and Wrought Iron Sleeve (WIS).
- Constructed of five 1" solid-wood sections.

**Finish Techniques**

Distressing	Heirlooming
	•

**Species Availability (Wood)**

Alder	Rustic Alder	Cherry	Rustic Hickory	Maple	Oak
•	Alder	•		•	•

**Species Availability (All Laminates)**

High Gloss box color	Horiz. Grain on Maple box color	Vert. Grain on Maple box color	Vert. Grain on Cherry box color	Vert. Grain on Oak box color

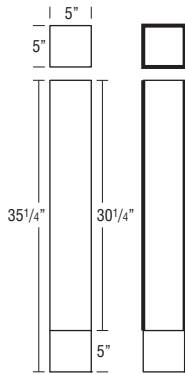

**DESCRIPTION**

**MODEL**

**PRICE**

**NEW** **SQUARE LEG with TAPERED FOOT, 4" WIDE, 35 1/4" HIGH**



**SQLEGTAP4**

865

- Trimmable.

**Finish Techniques**

Distressing	Heirlooming
	•

**Species Availability (Wood)**

Alder	Rustic Alder	Cherry	Rustic Hickory	Maple	Oak
•	Alder	•		•	•

**Species Availability (All Laminates)**

High Gloss box color	Horiz. Grain on Maple box color	Vert. Grain on Maple box color	Vert. Grain on Cherry box color	Vert. Grain on Oak box color

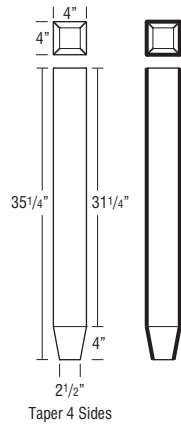

Taper 4 Sides

**NEW** **SQUARE LEG with TAPERED FOOT, 2" WIDE, 35 1/4" HIGH**



**SQLEGTAP2**

425

- Trimmable.

**Finish Techniques**

Distressing	Heirlooming
	•

**Species Availability (Wood)**

Alder	Rustic Alder	Cherry	Rustic Hickory	Maple	Oak
•	Alder	•		•	•

**Species Availability (All Laminates)**

High Gloss box color	Horiz. Grain on Maple box color	Vert. Grain on Maple box color	Vert. Grain on Cherry box color	Vert. Grain on Oak box color

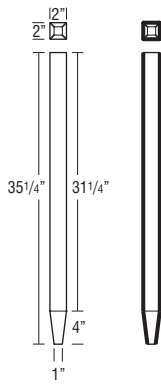

Taper 4 Sides

**URN LEG, 35 1/4" HIGH**



**JURNLEG**

864

- Trimmable.

**Finish Techniques**

Distressing	Heirlooming
	•

**Species Availability (Wood)**

Alder	Rustic Alder	Cherry	Rustic Hickory	Maple	Oak
•	Alder	•		•	•

**Species Availability (All Laminates)**

High Gloss box color	Horiz. Grain on Maple box color	Vert. Grain on Maple box color	Vert. Grain on Cherry box color	Vert. Grain on Oak box color

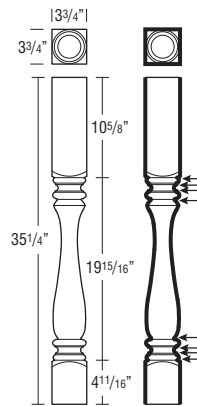

**NEW** **SQUARE LEG with TAPERED FOOT, 3" WIDE, 35 1/4" HIGH**



**SQLEGTAP3**

565

- Trimmable.

**Finish Techniques**

Distressing	Heirlooming
	•

**Species Availability (Wood)**

Alder	Rustic Alder	Cherry	Rustic Hickory	Maple	Oak
•	Alder	•		•	•

**Species Availability (All Laminates)**

High Gloss box color	Horiz. Grain on Maple box color	Vert. Grain on Maple box color	Vert. Grain on Cherry box color	Vert. Grain on Oak box color

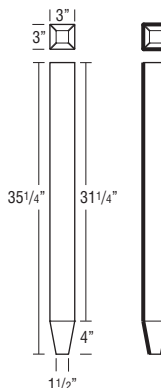

Taper 4 Sides

**URN LEG, 5" WIDE, 35 1/4" HIGH**



**JURNLEG**

1162

- Trimmable.

**Finish Techniques**

Distressing	Heirlooming
	•

**Species Availability (Wood)**

Alder	Rustic Alder	Cherry	Rustic Hickory	Maple	Oak
•	Alder	•		•	•

**Species Availability (All Laminates)**

High Gloss box color	Horiz. Grain on Maple box color	Vert. Grain on Maple box color	Vert. Grain on Cherry box color	Vert. Grain on Oak box color

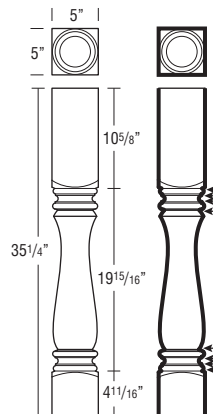

Finished edges indicated by bold lines on side view drawings.  
Glazed edges indicated by arrows on side view drawings.

**DESCRIPTION MODEL PRICE**

**ABBE FOOT, 4" HIGH**



**ABFOOT 308**

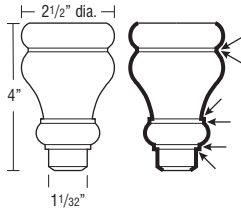

- Recommended for applications without toekicks.

**Finish Techniques**

Distressing	Heirlooming
	•

**Species Availability (Wood)**

Alder	Rustic Alder	Cherry	Rustic Hickory	Maple	Oak
•	Alder	•		•	•

**Species Availability (All Laminates)**

High Gloss box color	Horiz. Grain on Maple box color	Vert. Grain on Maple box color	Vert. Grain on Cherry box color	Vert. Grain on Oak box color
----------------------	---------------------------------	--------------------------------	---------------------------------	------------------------------

**COSMO FOOT, 4" HIGH**



**JCOSFOOT 312**

- Recommended for applications without toekicks.

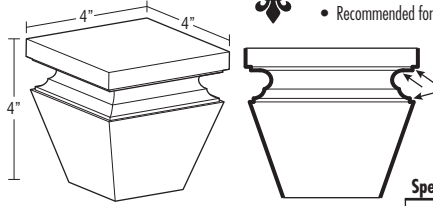

**Finish Techniques**

Distressing	Heirlooming
	•

**Species Availability (Wood)**

Alder	Rustic Alder	Cherry	Rustic Hickory	Maple	Oak
•	Alder	•		•	•

**Species Availability (All Laminates)**

High Gloss box color	Horiz. Grain on Maple box color	Vert. Grain on Maple box color	Vert. Grain on Cherry box color	Vert. Grain on Oak box color
----------------------	---------------------------------	--------------------------------	---------------------------------	------------------------------

**CRAFTSMAN FOOT, 4 1/2" HIGH**



**JCRAFTFOOT 175**

- Trimtable.

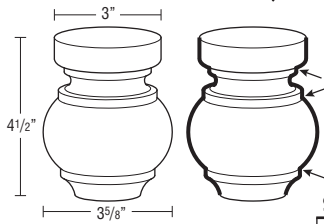

**Finish Techniques**

Distressing	Heirlooming
	•

**Species Availability (Wood)**

Alder	Rustic Alder	Cherry	Rustic Hickory	Maple	Oak
•	Alder	•		•	•

**Species Availability (All Laminates)**

High Gloss box color	Horiz. Grain on Maple box color	Vert. Grain on Maple box color	Vert. Grain on Cherry box color	Vert. Grain on Oak box color
----------------------	---------------------------------	--------------------------------	---------------------------------	------------------------------

**MADLINE FOOT, 4 1/2" HIGH**



**JMADEFOOT 312**

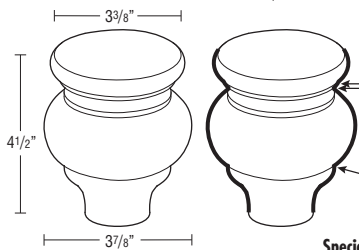

**Finish Techniques**

Distressing	Heirlooming
	•

**Species Availability (Wood)**

Alder	Rustic Alder	Cherry	Rustic Hickory	Maple	Oak
•	Alder	•		•	•

**Species Availability (All Laminates)**

High Gloss box color	Horiz. Grain on Maple box color	Vert. Grain on Maple box color	Vert. Grain on Cherry box color	Vert. Grain on Oak box color
----------------------	---------------------------------	--------------------------------	---------------------------------	------------------------------

**DESCRIPTION MODEL PRICE**

**METROPOLITAN FOOT, 4 5/8" HIGH**



**JMETROFOOT 226**

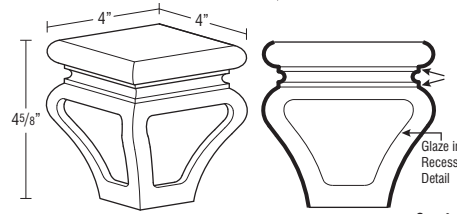

**Finish Techniques**

Distressing	Heirlooming
	•

**Species Availability (Wood)**

Alder	Rustic Alder	Cherry	Rustic Hickory	Maple	Oak
•	Alder	•		•	•

**Species Availability (All Laminates)**

High Gloss box color	Horiz. Grain on Maple box color	Vert. Grain on Maple box color	Vert. Grain on Cherry box color	Vert. Grain on Oak box color
----------------------	---------------------------------	--------------------------------	---------------------------------	------------------------------

**LARGE SQUARE FOOT, 5" HIGH**



**JLGSQFOOT 429**

- Trimtable.

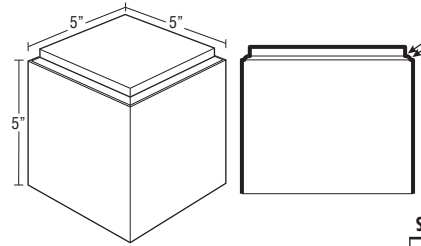

**Finish Techniques**

Distressing	Heirlooming
	•

**Species Availability (Wood)**

Alder	Rustic Alder	Cherry	Rustic Hickory	Maple	Oak
•	Alder	•		•	•

**Species Availability (All Laminates)**

High Gloss box color	Horiz. Grain on Maple box color	Vert. Grain on Maple box color	Vert. Grain on Cherry box color	Vert. Grain on Oak box color
----------------------	---------------------------------	--------------------------------	---------------------------------	------------------------------

**SQUARE FOOT, 4 1/2" HIGH**



**JSQFOOT 488**

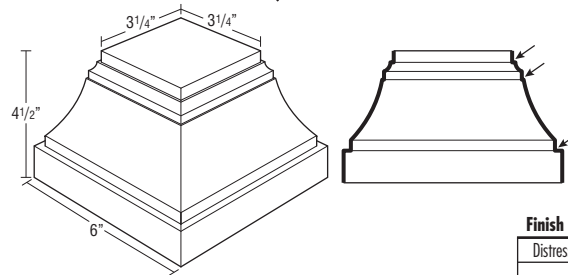

**Finish Techniques**

Distressing	Heirlooming
	•

**Species Availability (Wood)**

Alder	Rustic Alder	Cherry	Rustic Hickory	Maple	Oak
•	Alder	•		•	•

**Species Availability (All Laminates)**

High Gloss box color	Horiz. Grain on Maple box color	Vert. Grain on Maple box color	Vert. Grain on Cherry box color	Vert. Grain on Oak box color
----------------------	---------------------------------	--------------------------------	---------------------------------	------------------------------

Finished edges indicated by bold lines on side view drawings.  
Glazed edges indicated by arrows on side view drawings.

**DESCRIPTION**

**MODEL**

**PRICE**

**SQUARE FOOT, SPLIT,  
4 1/2" HIGH**



**JSQFOOTS**

341

- Trimable.

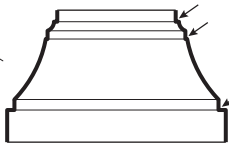
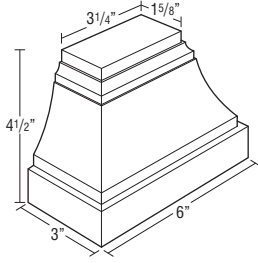

**Finish Techniques**

Distressing	Heirlooming
	•

**Species Availability (Wood)**

Alder	Rustic Alder	Cherry	Rustic Hickory	Maple	Oak
•	Alder	•		•	•

**Species Availability (All Laminates)**

High Gloss box color	Horiz. Grain on Maple box color	Vert. Grain on Maple box color	Vert. Grain on Cherry box color	Vert. Grain on Oak box color
-------------------------	---------------------------------------	--------------------------------------	---------------------------------------	------------------------------------

**LILLE FOOT, 4 1/2" HIGH**



**LIFOOT**

409

- Recommended for applications without toekicks.

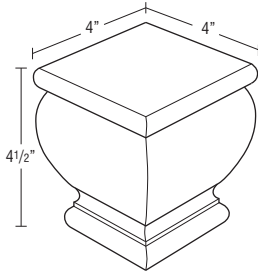

**Finish Techniques**

Distressing	Heirlooming
	•

**Species Availability (Wood)**

Alder	Rustic Alder	Cherry	Rustic Hickory	Maple	Oak
•	Alder	•		•	•

**Species Availability (All Laminates)**

High Gloss box color	Horiz. Grain on Maple box color	Vert. Grain on Maple box color	Vert. Grain on Cherry box color	Vert. Grain on Oak box color
-------------------------	---------------------------------------	--------------------------------------	---------------------------------------	------------------------------------

**NEW MID-CENTURY  
FOOT, SHORT,  
4 1/2" HIGH**



**MCFOOTS**

178

**Finish Techniques**

Distressing	Heirlooming
	•

**Species Availability (Wood)**

Alder	Rustic Alder	Cherry	Rustic Hickory	Maple	Oak
•	Alder	•		•	•

**Species Availability (All Laminates)**

High Gloss box color	Horiz. Grain on Maple box color	Vert. Grain on Maple box color	Vert. Grain on Cherry box color	Vert. Grain on Oak box color
-------------------------	---------------------------------------	--------------------------------------	---------------------------------------	------------------------------------

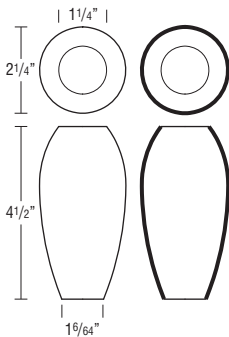

**DESCRIPTION**

**MODEL**

**PRICE**

**PLINTH BLOCK,  
4 1/2" HIGH**



**PLBLOCK**

187

- Trimable.

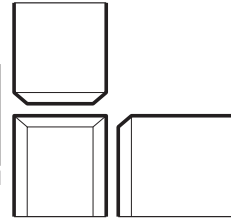
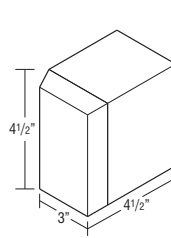

**Finish Techniques**

Distressing	Heirlooming
	•

**Species Availability (Wood)**

Alder	Rustic Alder	Cherry	Rustic Hickory	Maple	Oak
•	Alder	•	Hickory	•	•

**Species Availability (All Laminates)**

High Gloss box color	Horiz. Grain on Maple box color	Vert. Grain on Maple box color	Vert. Grain on Cherry box color	Vert. Grain on Oak box color
-------------------------	---------------------------------------	--------------------------------------	---------------------------------------	------------------------------------

**TAPERED LEG, 6" HIGH**



**TAPLG**

303

- Trimable.

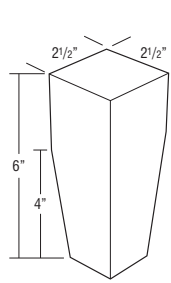

Taper 2 Sides



**Finish Techniques**

Distressing	Heirlooming
	•

**Species Availability (Wood)**

Alder	Rustic Alder	Cherry	Rustic Hickory	Maple	Oak
•	Alder	•		•	

**Species Availability (All Laminates)**

High Gloss box color	Horiz. Grain on Maple box color	Vert. Grain on Maple box color	Vert. Grain on Cherry box color	Vert. Grain on Oak box color
-------------------------	---------------------------------------	--------------------------------------	---------------------------------------	------------------------------------

**TOEKICK TULIP FOOT,  
4 5/8" HIGH**



**TKTLFOOT**

488

- Trimable.

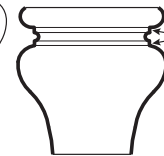
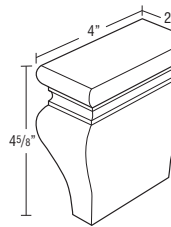

**Finish Techniques**

Distressing	Heirlooming
	•

**Species Availability (Wood)**

Alder	Rustic Alder	Cherry	Rustic Hickory	Maple	Oak
•	Alder	•		•	•

**Species Availability (All Laminates)**

High Gloss box color	Horiz. Grain on Maple box color	Vert. Grain on Maple box color	Vert. Grain on Cherry box color	Vert. Grain on Oak box color
-------------------------	---------------------------------------	--------------------------------------	---------------------------------------	------------------------------------

**TULIP FOOT, 4 5/8" HIGH**



**TLFOOT**

454

- Trimable.

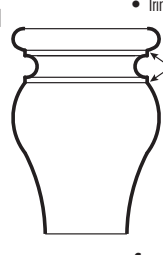
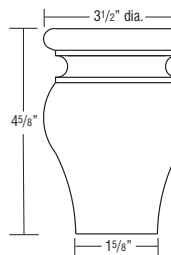

**Finish Techniques**

Distressing	Heirlooming
	•

**Species Availability (Wood)**

Alder	Rustic Alder	Cherry	Rustic Hickory	Maple	Oak
•	Alder	•		•	•

**Species Availability (All Laminates)**

High Gloss box color	Horiz. Grain on Maple box color	Vert. Grain on Maple box color	Vert. Grain on Cherry box color	Vert. Grain on Oak box color
-------------------------	---------------------------------------	--------------------------------------	---------------------------------------	------------------------------------

Finished edges indicated by bold lines on side view drawings.  
Glazed edges indicated by arrows on side view drawings.

**DESCRIPTION MODEL PRICE**

**2" DECORATIVE SPLIT TURNINGS**

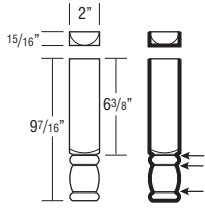

**SPRINGEND**

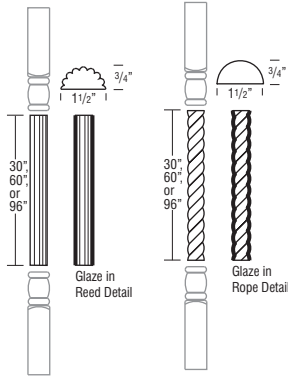

**SPRINGREED**

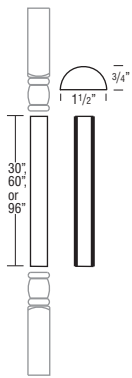

**SPRINGPOOL**

**SPRINGROPE**

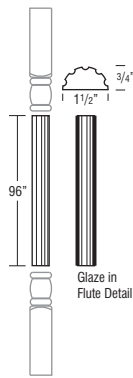

**JSPRINGFLT96**

<b>SPRINGEND</b> (Sold in Pairs)	71 /pair
<b>SPRINGREED30</b> (Reeded Half Round)	87
<b>SPRINGREED60</b> (Reeded Half Round)	121
<b>SPRINGREED96</b> (Reeded Half Round)	159
<b>SPRINGROPE30</b> (Rope Right Twist Half Round)	159
<b>SPRINGROPE60</b> (Rope Right Twist Half Round)	280
<b>SPRINGROPE96</b> (Rope Right Twist Half Round)	404
<b>SPRINGPOOL30</b> (Half Round)	87
<b>SPRINGPOOL60</b> (Half Round)	121
<b>SPRINGPOOL96</b> (Half Round)	159

**JSPRINGFLT96** (Half Round) 252

- Ends sold separately from split turnings.
- 5 day Express Response not available on Architectural Accents.

**Finish Techniques**

Distressing	Heirlooming
	•

**Species Availability (Wood)**

Alder	Rustic Alder	Cherry	Rustic Hickory	Maple	Oak
•	Alder	•	Hickory	•	•

♦ Not available in Rustic Hickory.

**Species Availability (All Laminates)**

High Gloss	Horiz. Grain on Maple	Vert. Grain on Maple	Vert. Grain on Cherry	Vert. Grain on Oak
box color	box color	box color	box color	box color

**DESCRIPTION MODEL PRICE**

**3" DECORATIVE SPLIT TURNINGS**

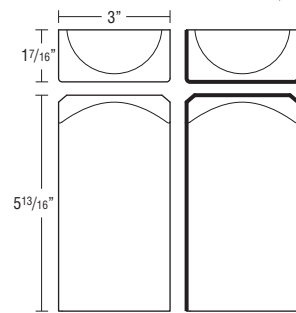

**J3SPRINGBLK**

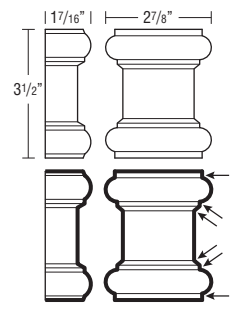

**J3SPRINGCTR**

<b>J3SPRINGBLK</b>	113
<b>J3SPRINGCTR</b>	67
<b>J3SPRINGSP96</b>	401
<b>J3SPRINGRP96</b>	711
<b>J3SPRINGRD96</b>	401
<b>J3SPRINGFL96</b>	401

- Ends sold separately.

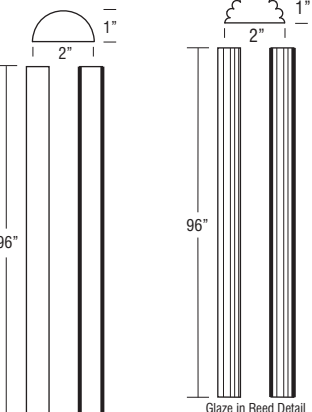

**J3SPRINGSP96**

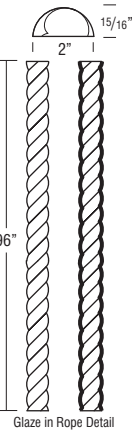

**J3SPRINGRP96**

**J3SPRINGRD96**

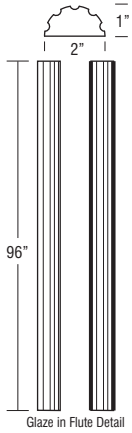

**J3SPRINGFL96**

**Finish Techniques**

Distressing	Heirlooming
	•

**Species Availability (Wood)**

Alder	Rustic Alder	Cherry	Rustic Hickory	Maple	Oak
•	Alder	•		•	•

**Species Availability (All Laminates)**

High Gloss	Horiz. Grain on Maple	Vert. Grain on Maple	Vert. Grain on Cherry	Vert. Grain on Oak
box color	box color	box color	box color	box color

Finished edges indicated by bold lines on side view drawings.  
Glazed edges indicated by arrows on side view drawings.

**DESCRIPTION**

**MODEL**

**PRICE**

**9" SMALL CORBEL**



**SMCORBEL**

614

- Not intended for cabinet or freestanding countertop support. For substantial weight support, use a floor mounted support such as a Decorative Leg.

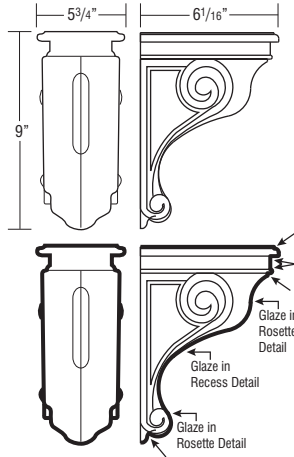

**Finish Techniques**

Distressing	Heirlooming
	•

**Species Availability (Wood)**

Rustic Alder	Cherry	Rustic Hickory	Maple	Oak
• Alder	•		•	•

**Species Availability (All Laminates)**

High Gloss box color	Horiz. Grain on Maple box color	Vert. Grain on Maple box color	Vert. Grain on Cherry box color	Vert. Grain on Oak box color
----------------------	---------------------------------	--------------------------------	---------------------------------	------------------------------

**DESCRIPTION**

**MODEL**

**PRICE**

**13" LARGE COSMO CORBEL**



**JCORBELCOS13**

1121

- Not intended for cabinet or freestanding countertop support. For substantial weight support, use a floor mounted support such as a Decorative Leg.

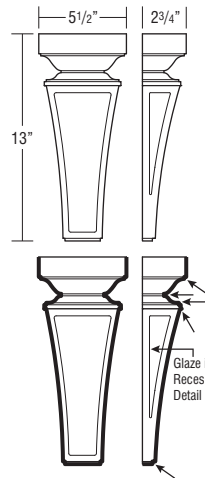

**Finish Techniques**

Distressing	Heirlooming
	•

**Species Availability (Wood)**

Rustic Alder	Cherry	Rustic Hickory	Maple	Oak
• Alder	•		•	

**Species Availability (All Laminates)**

High Gloss box color	Horiz. Grain on Maple box color	Vert. Grain on Maple box color	Vert. Grain on Cherry box color	Vert. Grain on Oak box color
----------------------	---------------------------------	--------------------------------	---------------------------------	------------------------------

**13" LARGE CORBEL**



**LGCORBEL**

780

- Not intended for cabinet or freestanding countertop support. For substantial weight support, use a floor mounted support such as a Decorative Leg.

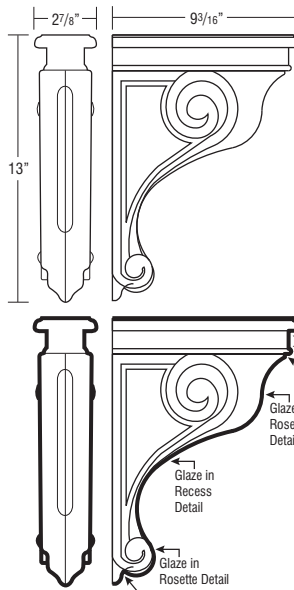

**Finish Techniques**

Distressing	Heirlooming
	•

**Species Availability (Wood)**

Rustic Alder	Cherry	Rustic Hickory	Maple	Oak
• Alder	•		•	•

**Species Availability (All Laminates)**

High Gloss box color	Horiz. Grain on Maple box color	Vert. Grain on Maple box color	Vert. Grain on Cherry box color	Vert. Grain on Oak box color
----------------------	---------------------------------	--------------------------------	---------------------------------	------------------------------

**13" LARGE COSMO CORBEL DEEP**



**JCORBELCOS13D**

1651

- Not intended for cabinet or freestanding countertop support. For substantial weight support, use a floor mounted support such as a Decorative Leg.

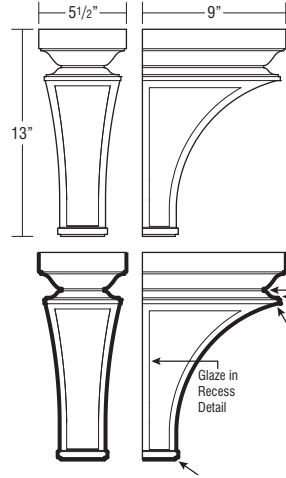

**Finish Techniques**

Distressing	Heirlooming
	•

**Species Availability (Wood)**

Rustic Alder	Cherry	Rustic Hickory	Maple	Oak
• Alder	•		•	•

**Species Availability (All Laminates)**

High Gloss box color	Horiz. Grain on Maple box color	Vert. Grain on Maple box color	Vert. Grain on Cherry box color	Vert. Grain on Oak box color
----------------------	---------------------------------	--------------------------------	---------------------------------	------------------------------

**9" ART CORBEL**



**CORBELART9**

712

- Not intended for cabinet or freestanding countertop support. For substantial weight support, use a floor mounted support such as a Decorative Leg.

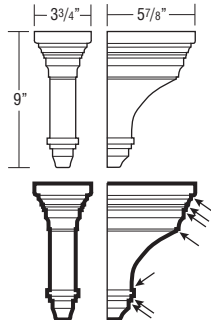

**Finish Techniques**

Distressing	Heirlooming
	•

**Species Availability (Wood)**

Rustic Alder	Cherry	Rustic Hickory	Maple	Oak
• Alder	•		•	•

**Species Availability (All Laminates)**

High Gloss box color	Horiz. Grain on Maple box color	Vert. Grain on Maple box color	Vert. Grain on Cherry box color	Vert. Grain on Oak box color
----------------------	---------------------------------	--------------------------------	---------------------------------	------------------------------

**7" COVE CORBEL**



**CORBELCOVE7**

241

- Not intended for cabinet or freestanding countertop support. For substantial weight support, use a floor mounted support such as a Decorative Leg.

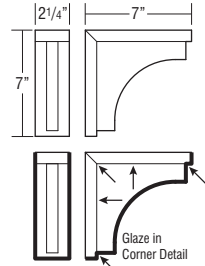

**Finish Techniques**

Distressing	Heirlooming
	•

**Species Availability (Wood)**

Rustic Alder	Cherry	Rustic Hickory	Maple	Oak
• Alder	•	Hickory	•	•

**Species Availability (All Laminates)**

High Gloss box color	Horiz. Grain on Maple box color	Vert. Grain on Maple box color	Vert. Grain on Cherry box color	Vert. Grain on Oak box color
----------------------	---------------------------------	--------------------------------	---------------------------------	------------------------------

Finished edges indicated by bold lines on side view drawings.  
Glazed edges indicated by arrows on side view drawings.

**DESCRIPTION MODEL PRICE**

**11 1/4" COVE CORBEL**



**CORBELCOVE11 262**

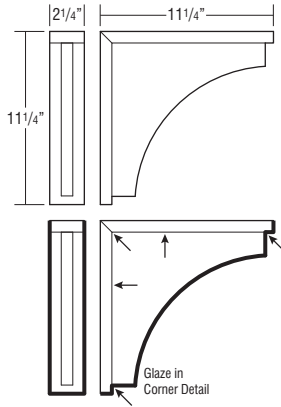

- Not intended for cabinet or freestanding countertop support. For substantial weight support, use a floor mounted support such as a Decorative Leg.

**Finish Techniques**

Distressing	Heirloom
	•

**Species Availability (Wood)**

Alder	Rustic Alder	Cherry	Rustic Hickory	Maple	Oak
•	Alder	•	Hickory	•	•

**Species Availability (All Laminates)**

High Gloss	Horiz. Grain on Maple	Vert. Grain on Maple	Vert. Grain on Cherry	Vert. Grain on Oak
box color	box color	box color	box color	box color

**6" MISSION CORBEL**



**CORBELMIS6 528**

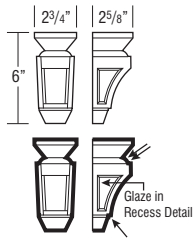

- Not intended for cabinet or freestanding countertop support. For substantial weight support, use a floor mounted support such as a Decorative Leg.

**Finish Techniques**

Distressing	Heirloom
	•

**Species Availability (Wood)**

Alder	Rustic Alder	Cherry	Rustic Hickory	Maple	Oak
•	Alder	•	Hickory	•	•

**Species Availability (All Laminates)**

High Gloss	Horiz. Grain on Maple	Vert. Grain on Maple	Vert. Grain on Cherry	Vert. Grain on Oak
box color	box color	box color	box color	box color

**9" MISSION CORBEL**



**CORBELMIS9 614**

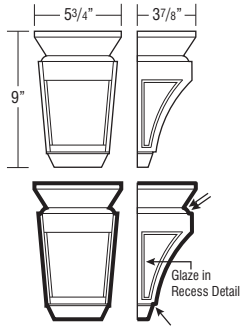

- Not intended for cabinet or freestanding countertop support. For substantial weight support, use a floor mounted support such as a Decorative Leg.

**Finish Techniques**

Distressing	Heirloom
	•

**Species Availability (Wood)**

Alder	Rustic Alder	Cherry	Rustic Hickory	Maple	Oak
•	Alder	•	Hickory	•	•

**Species Availability (All Laminates)**

High Gloss	Horiz. Grain on Maple	Vert. Grain on Maple	Vert. Grain on Cherry	Vert. Grain on Oak
box color	box color	box color	box color	box color

**5" OLD WORLD CORBEL**



**CORBELWD5 406**

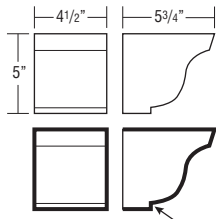

- Not intended for cabinet or freestanding countertop support. For substantial weight support, use a floor mounted support such as a Decorative Leg.

**Finish Techniques**

Distressing	Heirloom
	•

**Species Availability (Wood)**

Alder	Rustic Alder	Cherry	Rustic Hickory	Maple	Oak
•	Alder	•	Hickory	•	•

**Species Availability (All Laminates)**

High Gloss	Horiz. Grain on Maple	Vert. Grain on Maple	Vert. Grain on Cherry	Vert. Grain on Oak
box color	box color	box color	box color	box color

**DESCRIPTION MODEL PRICE**

**7 1/2" OLD WORLD CORBEL**



**JCORBELOWD7 568**

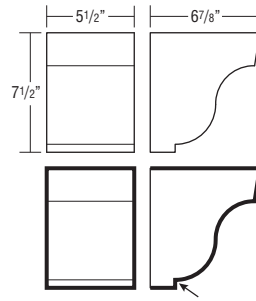

- Not intended for cabinet or freestanding countertop support. For substantial weight support, use a floor mounted support such as a Decorative Leg.

**Finish Techniques**

Distressing	Heirloom
	•

**Species Availability (Wood)**

Alder	Rustic Alder	Cherry	Rustic Hickory	Maple	Oak
•	Alder	•	Hickory	•	•

**Species Availability (All Laminates)**

High Gloss	Horiz. Grain on Maple	Vert. Grain on Maple	Vert. Grain on Cherry	Vert. Grain on Oak
box color	box color	box color	box color	box color

**11 1/4" SNACK BAR SUPPORT**



**SBS 221**

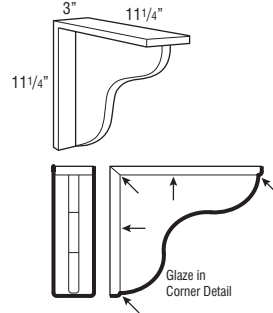

- Not intended for cabinet or freestanding countertop support. For substantial weight support, use a floor mounted support such as a Decorative Leg.

**Finish Techniques**

Distressing	Heirloom
	•

**Species Availability (Wood)**

Alder	Rustic Alder	Cherry	Rustic Hickory	Maple	Oak
•	Alder	•	Hickory	•	•

**Species Availability (All Laminates)**

High Gloss	Horiz. Grain on Maple	Vert. Grain on Maple	Vert. Grain on Cherry	Vert. Grain on Oak
box color	box color	box color	box color	box color

**11 1/2" ARTS & CRAFTS BRACKET**



**JBRACKETART 446**

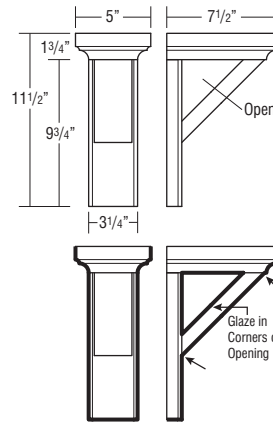

- Not intended for cabinet or freestanding countertop support. For substantial weight support, use a floor mounted support such as a Decorative Leg.

**Finish Techniques**

Distressing	Heirloom
	•

**Species Availability (Wood)**

Alder	Rustic Alder	Cherry	Rustic Hickory	Maple	Oak
•	Alder	•	Hickory	•	•

**Species Availability (All Laminates)**

High Gloss	Horiz. Grain on Maple	Vert. Grain on Maple	Vert. Grain on Cherry	Vert. Grain on Oak
box color	box color	box color	box color	box color

Finished edges indicated by bold lines on side view drawings.  
Glazed edges indicated by arrows on side view drawings.

**DESCRIPTION**

**12" CRAFTSMAN OPEN BRACKET**

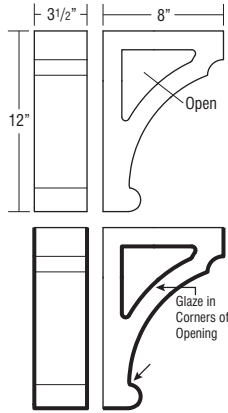

**MODEL**

**JCORBELCRAFTO**

**PRICE**

**844**

- Not intended for cabinet or freestanding countertop support. For substantial weight support, use a floor mounted support such as a Decorative Leg.

**Finish Techniques**

Distressing	Heirloom
	•

**Species Availability (Wood)**

Alder	Rustic Alder	Cherry	Rustic Hickory	Maple	Oak
•	Alder	•		•	•

**Species Availability (All Laminates)**

High Gloss box color	Horiz. Grain on Maple box color	Vert. Grain on Maple box color	Vert. Grain on Cherry box color	Vert. Grain on Oak box color
----------------------	---------------------------------	--------------------------------	---------------------------------	------------------------------

**6 1/2" SMALL SHAKER CORBEL**

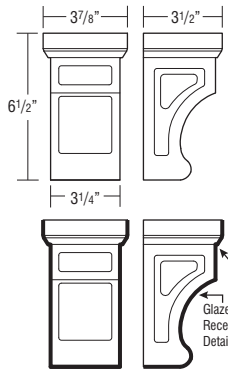

**JCORBELSHKR7**

**591**

- Not intended for cabinet or freestanding countertop support. For substantial weight support, use a floor mounted support such as a Decorative Leg.

**Finish Techniques**

Distressing	Heirloom
	•

**Species Availability (Wood)**

Alder	Rustic Alder	Cherry	Rustic Hickory	Maple	Oak
•	Alder	•		•	•

**Species Availability (All Laminates)**

High Gloss box color	Horiz. Grain on Maple box color	Vert. Grain on Maple box color	Vert. Grain on Cherry box color	Vert. Grain on Oak box color
----------------------	---------------------------------	--------------------------------	---------------------------------	------------------------------

**13 3/8" MEDIUM SHAKER CORBEL**

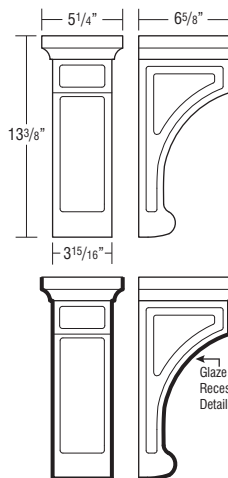

**JCORBELSHKR14**

**1121**

- Not intended for cabinet or freestanding countertop support. For substantial weight support, use a floor mounted support such as a Decorative Leg.

**Finish Techniques**

Distressing	Heirloom
	•

**Species Availability (Wood)**

Alder	Rustic Alder	Cherry	Rustic Hickory	Maple	Oak
•	Alder	•		•	•

**Species Availability (All Laminates)**

High Gloss box color	Horiz. Grain on Maple box color	Vert. Grain on Maple box color	Vert. Grain on Cherry box color	Vert. Grain on Oak box color
----------------------	---------------------------------	--------------------------------	---------------------------------	------------------------------

**DESCRIPTION**

**NEW 5 1/2" TRIAD CORBEL**

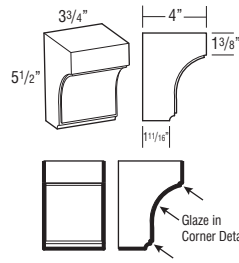

**MODEL**

**CORBELTRIAD6**

**PRICE**

**421**

- Not intended for cabinet or freestanding countertop support. For substantial weight support, use a floor mounted support such as a Decorative Leg.

**Finish Techniques**

Distressing	Heirloom
	•

**Species Availability (Wood)**

Alder	Rustic Alder	Cherry	Rustic Hickory	Maple	Oak
•	Alder	•		•	•

**Species Availability (All Laminates)**

High Gloss box color	Horiz. Grain on Maple box color	Vert. Grain on Maple box color	Vert. Grain on Cherry box color	Vert. Grain on Oak box color
----------------------	---------------------------------	--------------------------------	---------------------------------	------------------------------

**NEW 9" TRIAD CORBEL, NARROW**

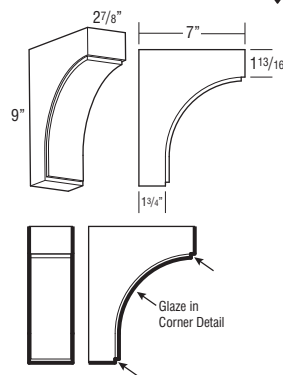

**CORBELTRIAD9N**

**505**

- Not intended for cabinet or freestanding countertop support. For substantial weight support, use a floor mounted support such as a Decorative Leg.

**Finish Techniques**

Distressing	Heirloom
	•

**Species Availability (Wood)**

Alder	Rustic Alder	Cherry	Rustic Hickory	Maple	Oak
•	Alder	•		•	•

**Species Availability (All Laminates)**

High Gloss box color	Horiz. Grain on Maple box color	Vert. Grain on Maple box color	Vert. Grain on Cherry box color	Vert. Grain on Oak box color
----------------------	---------------------------------	--------------------------------	---------------------------------	------------------------------

**NEW 12" TRIAD CORBEL**

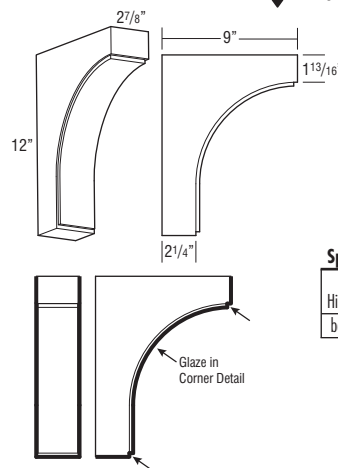

**CORBELTRIAD12**

**561**

- Not intended for cabinet or freestanding countertop support. For substantial weight support, use a floor mounted support such as a Decorative Leg.

**Finish Techniques**

Distressing	Heirloom
	•

**Species Availability (Wood)**

Alder	Rustic Alder	Cherry	Rustic Hickory	Maple	Oak
•	Alder	•		•	•

**Species Availability (All Laminates)**

High Gloss box color	Horiz. Grain on Maple box color	Vert. Grain on Maple box color	Vert. Grain on Cherry box color	Vert. Grain on Oak box color
----------------------	---------------------------------	--------------------------------	---------------------------------	------------------------------

Finished edges indicated by bold lines on side view drawings.  
Glazed edges indicated by arrows on side view drawings.



**DESCRIPTION MODEL PRICE**

**NEW 9" BAUHAUS CORBEL**



**CORBELBAUAL9 525**  
**CORBELBAUWI9 525**

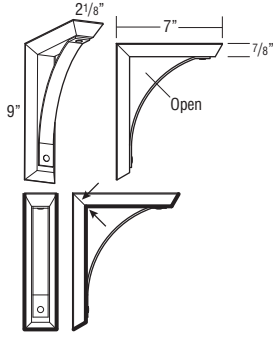

- Finishes available: Brushed Aluminum (AL) and Wrought Iron (WI).
- Not intended for cabinet or freestanding countertop support. For substantial weight support, use a floor mounted support such as a Decorative Leg.

**Finish Techniques**

Distressing	Heirlooming
	•

**Species Availability (Wood)**

Alder	Rustic Alder	Cherry	Rustic Hickory	Maple	Oak
•	Alder	•	Hickory	•	•

**Species Availability (All Laminates)**

High Gloss	Horiz. Grain on Maple	Vert. Grain on Maple	Vert. Grain on Cherry	Vert. Grain on Oak
box color	box color	box color	box color	box color

**NEW 12" BAUHAUS CORBEL**



**CORBELBAUAL12 656**  
**CORBELBAUWI12 656**

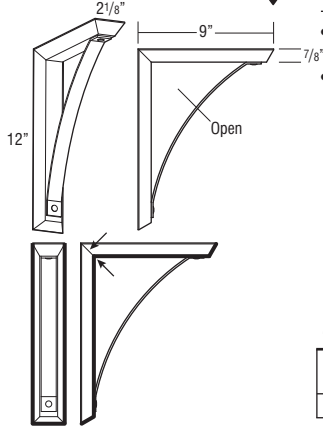

- Finishes available: Brushed Aluminum (AL) and Wrought Iron (WI).
- Not intended for cabinet or freestanding countertop support. For substantial weight support, use a floor mounted support such as a Decorative Leg.

**Finish Techniques**

Distressing	Heirlooming
	•

**Species Availability (Wood)**

Alder	Rustic Alder	Cherry	Rustic Hickory	Maple	Oak
•	Alder	•	Hickory	•	•

**Species Availability (All Laminates)**

High Gloss	Horiz. Grain on Maple	Vert. Grain on Maple	Vert. Grain on Cherry	Vert. Grain on Oak
box color	box color	box color	box color	box color

**DESCRIPTION MODEL PRICE**

**SINGLE OUTLET COVER**



**JSOC 153**

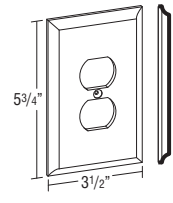

**Finish Techniques**

Distressing	Heirlooming

**Species Availability (Wood)**

Alder	Rustic Alder	Cherry	Rustic Hickory	Maple	Oak
•	Alder	•		•	•

**Species Availability (All Laminates)**

High Gloss	Horiz. Grain on Maple	Vert. Grain on Maple	Vert. Grain on Cherry	Vert. Grain on Oak
box color	box color	box color	box color	box color

**SINGLE ROCKER PLATE**



**JSRC 153**

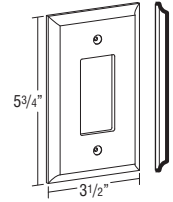

**Finish Techniques**

Distressing	Heirlooming

**Species Availability (Wood)**

Alder	Rustic Alder	Cherry	Rustic Hickory	Maple	Oak
•	Alder	•		•	•

**Species Availability (All Laminates)**

High Gloss	Horiz. Grain on Maple	Vert. Grain on Maple	Vert. Grain on Cherry	Vert. Grain on Oak
box color	box color	box color	box color	box color

Finished edges indicated by bold lines on side view drawings.  
 Glazed edges indicated by arrows on side view drawings.

DESCRIPTION	MODEL	PRICE
<b>CONTEMPORARY EMBELLISHMENTS</b>		

**METAL FEET, ANGLED**

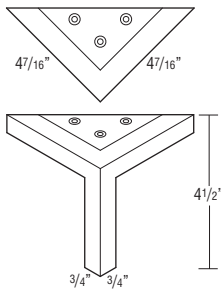

<b>FOOTMETALANGBN</b>	282
<b>FOOTMETALANGPC</b>	282

- BN = Brushed Nickel
- PC = Polished Chrome
- Maximum weight capacity is 160 lbs.

**METAL FEET, ROUND**

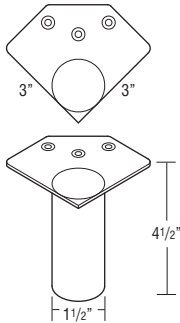

<b>FOOTMETALRDBS</b>	282
<b>FOOTMETALRDPS</b>	282

- BS = Brushed Stainless
- PS = Polished Stainless
- Maximum weight capacity is 150 lbs.

**METAL FEET, SQUARE**

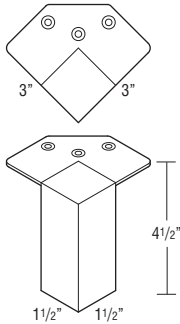

<b>FOOTMETALSQBS</b>	282
<b>FOOTMETALSQPS</b>	282

- BS = Brushed Stainless
- PS = Polished Stainless

**METAL FEET, TEE**

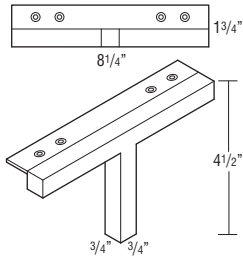

<b>FOOTMETALANGBTN</b>	282
<b>FOOTMETALANGTPC</b>	282

- BN = Brushed Nickel
- PC = Polished Chrome

**TOUCH LATCH**

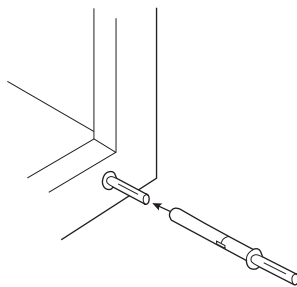

<b>TOUHLATCH</b>	33
------------------	----

- Nylon gray mechanism with bumper tip.
- Face frame will need to be field drilled for insertion of the TOUCHLATCH, requires 25/64" (10mm) drill bit.
- Can be field adjusted for door gap depth, no tools required.
- For use on full overlay door styles only.
- Requires a soft touch to open the door, and door must be pushed closed to reset the TOUCHLATCH mechanism.
- Only for use on hinged doors, and can be used without decorative hardware. Not compatible with non-hinged doors such as pull-outs, Wall Vertical-Lift (WVL...). For drawers, pull-outs, and other non-compatible cabinets, PULLH105, PULLH106, and PULLH107 are recommended (see page 575).

DESCRIPTION	MODEL	PRICE
-------------	-------	-------

**TRUSS METAL CORBEL, STAINLESS STEEL**

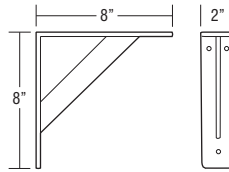

<b>CORBELTRSS</b>	840
-------------------	-----

- Pre-drilled mounting holes for easy installation.
- 1/4" material thickness.
- Not intended for cabinet or freestanding countertop support. For substantial weight support, use a floor mounted support such as a Decorative Leg.
- Must be properly installed into a structural member of the wall.

**NEW MID-CENTURY TRIANGLE BRACKET, 12 3/4" DEEP**

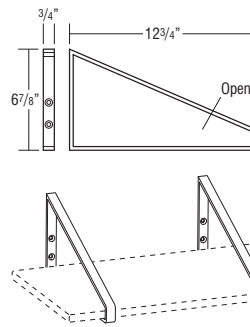

<b>TRIBRKT12GMG</b>	485
<b>TRIBRKT12SN</b>	485
<b>TRIBRKT12WI</b>	485
<b>TRIBRKT12SS</b>	485

- Finishes available: Gun Metal Gray (GMG), Satin Nickel (SN), Wrought Iron (WI), and Stainless Steel (SS).
- Includes matching hardware.
- Pre-drilled mounting holes for easy installation.
- Designed for a 12" deep, 3/4" thick shelf to be placed inside bracket. See Exterior Shelf (ES12...) on page 569 and Modern Corner Shelf (MDCCRNSHLF) on page 569. When used with MDCCRNSHLF, four brackets are recommended.
- 1/4" material thickness.
- Not intended for cabinet or freestanding countertop support. For substantial weight support, use a floor mounted support such as a Decorative Leg.
- Must be properly installed into a structural member of the wall.
- Sold individually. Recommended to use two brackets on shelves up to 48" wide, additional brackets should be added on wider shelves.

**NEW INDUSTRIAL BRACKET, LOOP, 8 7/8" DEEP**

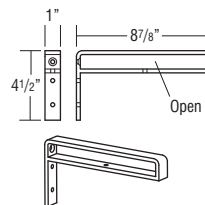

<b>BRACKETIND9SS</b>	513
<b>BRACKETIND9GMG</b>	528
<b>BRACKETIND9WI</b>	385

- On the stainless steel versions, the screws are countersunk.
- Finishes available: Stainless Steel (SS), Gun Metal Gray (GMG), and Wrought Iron (WI).
- Open area for 8" deep shelf placement is 15/16" high, shelf is to be secured with a screw in the bottom loop.
- Pre-drilled mounting holes for easy installation.
- 1/4" material thickness.
- Must be properly installed into a structural member of the wall.
- Sold individually. Recommended to use two brackets on shelves up to 48" wide, additional brackets should be added on wider shelves.

**NEW INDUSTRIAL BRACKET, LOOP, 12 7/8" DEEP**

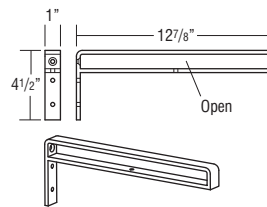

<b>BRACKETIND13SS</b>	556
<b>BRACKETIND13GMG</b>	605
<b>BRACKETIND13WI</b>	440

- On the stainless steel versions, the screws are countersunk.
- Finishes available: Stainless Steel (SS), Gun Metal Gray (GMG), and Wrought Iron (WI).
- Open area for 12" deep shelf placement is 15/16" high, shelf is to be secured with a screw in the bottom loop.
- Pre-drilled mounting holes for easy installation.
- 1/4" material thickness.
- Must be properly installed into a structural member of the wall.
- Sold individually. Recommended to use two brackets on shelves up to 48" wide, additional brackets should be added on wider shelves.

DESCRIPTION	MODEL	PRICE
-------------	-------	-------

**NEW** INDUSTRIAL BRACKET,  
STRAIGHT, 8 1/2" DEEP

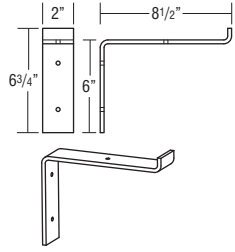

STBRACKETIND9SS	466
STBRACKETIND9G	480
STBRACKETIND9WI	350

- On the stainless steel versions, the screws are countersunk.
- Finishes available: Stainless Steel (SS), Gun Metal Gray (G), and Wrought Iron (WI).
- Pre-drilled mounting holes for easy installation.
- 1/4" material thickness.
- Not intended for cabinet or freestanding countertop support. For substantial weight support, use a floor mounted support such as a Decorative Leg.
- Must be properly installed into a structural member of the wall.

**NEW** INDUSTRIAL BRACKET,  
STRAIGHT, 12 1/2" DEEP

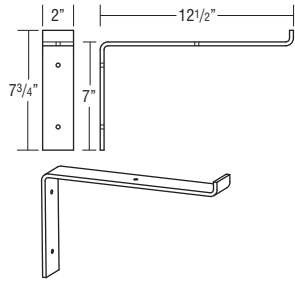

STBRACKETIND13S	505
STBRACKETIND13G	550
STBRACKETIND13W	400

- On the stainless steel versions, the screws are countersunk.
- Finishes available: Stainless Steel (S), Gun Metal Gray (G), and Wrought Iron (W).
- Pre-drilled mounting holes for easy installation.
- 1/4" material thickness.
- Not intended for cabinet or freestanding countertop support. For substantial weight support, use a floor mounted support such as a Decorative Leg.
- Must be properly installed into a structural member of the wall.
- Sold individually. Recommended to use two brackets on shelves up to 48" wide, additional brackets should be added on wider shelves.

SHELF SUPPORT BRACKET,  
SATIN NICKEL

SHELFBRKTSN 392

- Sold in pairs.
- Can be used with glass shelves 0.28"-0.75" (7-19mm) thick, or wood shelves 0.5"-1.61" (12-41mm) thick.
- Must be properly installed into a structural member of the wall.
- Maximum shelf load varies with shelf depth. For a 12" deep shelf, maximum shelf load is 50 lbs. each including shelf weight.

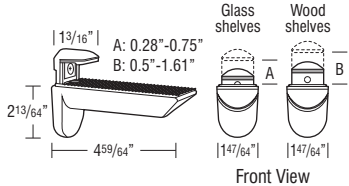

DESCRIPTION	MODEL	PRICE
-------------	-------	-------

SHELVES		
---------	--	--

FLOATING SHELVES	MODEL	PRICE
	FS24	474
	FS30	541
	FS36	611
	FS42	677
	FS48 ♦	868
	FS54 ♦	924
	FS60 ♦	980

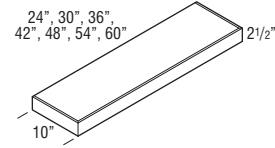

Maximum Weight Capacity per Shelf	
FS24	25 lbs.
FS30	31 lbs.
FS36	37 lbs.
FS42	43 lbs.
FS48	50 lbs.
FS54	56 lbs.
FS60	62 lbs.

- 3/4" thick solid-wood front, back, and ends. 3/8" thick veneered Medium Density Fiberboard (MDF) top and bottom. When a Paint finish is specified, veneer may not be applied. Front and ends are mitered together.

Finish Techniques	
Distressing	Heirloom

**Species Availability (Wood)**

Alder	Rustic Alder	Cherry	Rustic Hickory	Maple	Oak
•	Alder	•		•	•

♦ Only available in Cherry and Maple.

**Species Availability (All Laminates)**

High Gloss	Horiz. Grain on Maple	Vert. Grain on Maple	Vert. Grain on Cherry	Vert. Grain on Oak
box color	box color	box color	box color	box color

♦ Only available in Cherry and Maple box colors.

**NEW** MODERN CORNER SHELF, 30" x 30" x 3/4"

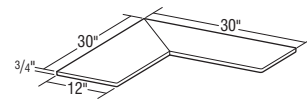

MODEL	PRICE
MDCCRNSHLF	850

- Constructed of 3/4" wood panels.
- Top, bottom, front, and sides are finished, back two edges are not finished.
- Compatible with the Mid-century Triangle Bracket (TRIBRKT12\_\_, see page 567).

Finish Techniques	
Distressing	Heirloom
	•

**Species Availability (Wood)**

Alder	Rustic Alder	Cherry	Rustic Hickory	Maple	Oak
•	Alder			•	•

**Species Availability (All Laminates)**

High Gloss	Horiz. Grain on Maple	Vert. Grain on Maple	Vert. Grain on Cherry	Vert. Grain on Oak
box color	box color	box color	box color	box color

**NEW** MODERN CORNER FLOATING SHELF, 30" x 30" x 2 1/2"

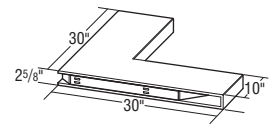

MODEL	PRICE
MDFLCRNSHLF	2750

- Installation kit included.
- Maximum weight capacity is 52 lbs.
- 3/4" thick solid-wood front and ends. 3/8" thick veneered top and bottom.

Finish Techniques	
Distressing	Heirloom
	•

**Species Availability (Wood)**

Alder	Rustic Alder	Cherry	Rustic Hickory	Maple	Oak
•	Alder	•		•	•

**Species Availability (All Laminates)**

High Gloss	Horiz. Grain on Maple	Vert. Grain on Maple	Vert. Grain on Cherry	Vert. Grain on Oak
box color	box color	box color	box color	box color

DESCRIPTION	MODEL	PRICE
-------------	-------	-------

EXTERIOR SHELVES, 12", 18", 21", or 24" DEEP		
--	--	--

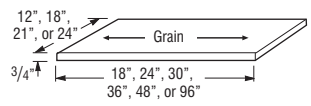

ES1218	93
ES1224	123
ES1230	154
ES1236	183
ES1248	237
ES1296†	490

ES1818	137
ES1824	183
ES1830	231
ES1836	278
ES1848	368
ES1896†	736

ES2118	161
ES2124	214
ES2130	269
ES2136	323
ES2148	429
ES2196†	860

ES2418	183
ES2424	245
ES2430	306
ES2436	368
ES2448	490
ES2496†	981

- Wood 3/4" panels are veneered furniture board finished both sides, and front and side edges (back edge is not finished).
- Not available in wood grain laminates.
- Shelves can be ordered in APC.
- † 5 day Express Response not available on items over 48".

Custom Modifications		Finish Techniques	
ID	RD	Distressing	Heirloom
•	•		

**Species Availability (Wood)**

Alder	Rustic Alder	Cherry	Rustic Hickory	Maple	Oak
•	Alder	•		•	•

**Species Availability (All Laminates)**

High Gloss	Horiz. Grain on Maple	Vert. Grain on Maple	Vert. Grain on Cherry	Vert. Grain on Oak
box color	box color	box color	box color	box color

**DESCRIPTION MODEL PRICE**

**FULL DEPTH INTERIOR SHELVES**

To Fit 12" & 24" Deep Cabinets

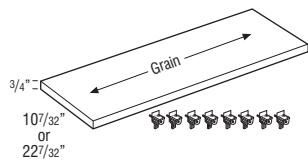

SK912	71
SK1212	71
SK1512	71
SK1812	87
SK2112	87
SK2412	87
SK2712	100
SK3012	100
SK3312	100
SK3612	116
SK3912	116
SK4212	116
SK4812	130
SK924	93
SK1224	93
SK1524	93
SK1824	108
SK2124	108
SK2424	108
SK2724	121
SK3024	121
SK3324	121
SK3624	137
SK3924	137
SK4224	137
SK4824	151

- SK\_\_12 includes one 10 7/32" deep shelf. SK\_\_24 includes one 22 7/32" deep shelf.
- Each kit includes 8 shelf pegs.
- Shelving material specific to construction option. See page 39 for construction details.
- Specify material when ordering.
- Full Depth Shelves will be shipped separate from the cabinet.
- If matching interior is desired, order shelf kit (SK\_\_\_\_) with Matching Interior Plywood (MIP) modification.

Custom Modifications				Construction Upgrades
ID	MIP	RD	WLI	APC
•	•	•	•	•

**DESCRIPTION MODEL PRICE**

**GLASS SHELF KIT, 6" & 9" DEEP**

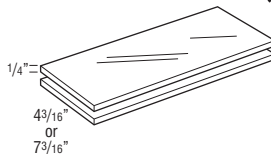

JGSK1206	162
JGSK1506	167
JGSK1806	172
JGSK2106	197
JGSK2406	206
JGSK2706	210
JGSK3006	214
JGSK3306	227
JGSK3606	238
JGSK1209	162
JGSK1509	167
JGSK1809	172
JGSK2109	197
JGSK2409	206
JGSK2709	210
JGSK3009	214
JGSK3309	227
JGSK3609	238

- JGSK cannot be trimmed.
- Kit includes two 1/4" tempered shelves.
- Example: JGSK1206 = 10 9/32" x 4 3/16" to fit W1230x6 cabinet.
- Not compatible with the FFD modification.

**GLASS SHELF KIT, 12" DEEP**

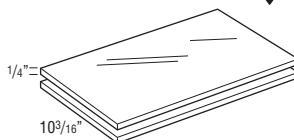

JGSK912	157
JGSK1212	162
JGSK1512	167
JGSK1812	172
JGSK2112	197
JGSK2412	206
JGSK2712	210
JGSK3012	214
JGSK3312	227
JGSK3612	238

- JGSK cannot be trimmed.
- Kit includes two 1/4" tempered shelves.
- Example: JGSK1512 = 13 9/32" wide x 10 3/16" deep fits in W1530x12 Deep Cabinet.

Custom Modifications	
ID	RD
•	

**GLASS SHELF KIT, DIAGONAL**

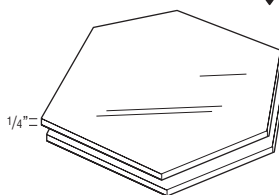

JGSKDW24 (Fits DW..2424)	327
JGSKDW27 (Fits DW..2727)	327

- JGSK cannot be trimmed.
- Kit includes two 1/4" tempered shelves.
- Not available for 24" and 27" high Diagonal Wall cabinets. Shelf will not fit through door opening.
- Not available for Diagonal Wall cabinets specified with Peninsula modification.

DESCRIPTION	MODEL	PRICE
-------------	-------	-------

**LIGHTING**

- LEDs are a solid state lighting source. LEDs are more efficient, durable, and safer than older light sources.
- CW = Cool White (Kelvin rating: 5000)
- WW = Warm White (Kelvin rating: 3200)
- Installed lighting products are not available in California, with the exception of the Battery Strip Light (BATTLT).

**LED PUCK LIGHTING, STANDARD**



MODEL	PRICE
<b>PUCK18CW</b>	102
<b>PUCK18WW</b>	102

- Contains 18 LED diodes with a life span of 50,000 hours.
- Measures less than 1/4" for low profile surface mounting.
- 65° beam angle.
- Compatible with Dimmable Driver (DIMM241512) and Power Extension Cable (CABL2500).
- Available in: warm or cool white in plastic housing with an aluminum color finish.
- Puck dimension is 2.56" x 2.56" (65mm x 65mm).
- Power usage: 1.25 watts.
- Voltage: 24V Compatibility.

**LED PUCK LIGHTING, HIGH DEFINITION**



surface mount

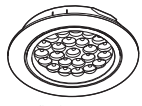

flush mount



MODEL	PRICE
<b>PUCK24WW</b>	140

- Contains 24 LED diodes with a life span of 50,000 hours.
- Surface or flush mounted (remove ring for flush mounting).
- 50° beam angle.
- Compatible with Dimmable Driver (DIMM241512) and Power Extension Cable (CABL2500).
- Available in: warm or cool white light in aluminum housing.
- Puck diameter is 2.58" (65.5mm) and height is 0.41" (10.5mm).
- Power usage: 1.65 watts.
- Voltage: 24V Compatibility.

**LED FLEXIBLE STRIP**



MODEL	PRICE
<b>FLEX12CW</b>	91
<b>FLEX12WW</b>	91
<b>FLEX36WW</b>	324

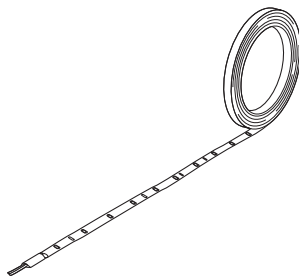

- Linkable and trimmable in increments of either 3" (FLEX12..) or 3 1/4" (FLEX36..), not to exceed a total of 18'.
- Adhesive back.
- Compatible with Dimmable Driver (DIMM121512) and Flex Driver Connection Lead (LEADDFLX2500).
- Suggested use: installed over cabinet, under cabinet, in cabinet, and on the toekick.
- Available in: warm or cool white.
- FLEX12.. Dimensions: Length 11.81" (300mm), Width 0.31" (8mm), and Depth 0.1" (2.5mm).
- FLEX36.. Dimensions: Length: 39.37" (1000mm), Width 0.31" (8mm), and Depth 0.1" (2.5mm).
- Power usage: 0.8 watts (FLEX12..) and 2.5 watts (FLEX36..).
- Voltage: 12V Compatibility.

DESCRIPTION	MODEL	PRICE
-------------	-------	-------

**LED RIGID STRIP**



<b>RIGID12CW</b>	72
<b>RIGID12WW</b>	72
<b>RIGID24WW</b>	106



- Linkable.
- Suggested use: straight runs (use link wires for corners).
- Available in 12 or 24 diodes per stick.
- Easy-to-clean, protective shell.
- Compatible with Dimmable Driver (DIMM121512) and Rigid Driver Connection Cable (CABLRIDG2500).
- Available in: warm or cool white.
- Includes brackets and screws for easy installation.
- 50,000 hour life span.
- Dimensions (12 Diodes): Length 11.81" (300mm), Width 0.31" (8mm), and Depth 0.24" (6mm).
- Dimensions (24 Diodes): Length 11.22" (285mm), Width 0.31" (8mm), and Depth 0.24" (6mm).
- Power usage: 0.8 watts (RIGID12..) and 1.5 watts (RIGID24..).
- Voltage: 12V Compatibility.

**BATTERY STRIP LIGHT**



MODEL	PRICE
<b>BATTLT</b>	149

- Battery operated – (4) AAA batteries (not included).
- Motion activated.
- Low power usage (0.3W).
- Plastic aluminum finish.
- Dimensions: Length 11.93" (303mm), Width 0.67" (17mm), and Depth 0.55" (14mm).
- Easy adhesive install.

**STANDARD DRIVERS**



<b>STAND1264</b>	124
<b>STAND2464</b>	124
<b>STAND121512</b>	218
<b>STAND123012</b>	287
<b>STAND243012</b>	287
<b>STAND242012</b>	246

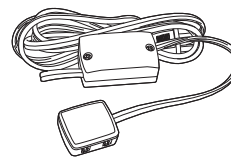

STAND1264  
STAND2464

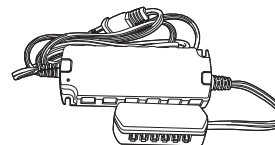

STAND121512

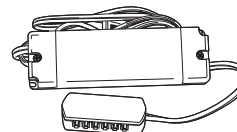

STAND123012  
STAND243012

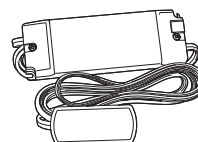

STAND242012

- Product Codes list the driver voltage, watts, and connector ports, such as STAND123012 is 12V, 30W, and 12 connector ports.

	Voltage	Wattage (Max Load)	Connector Ports
STAND1264	12	6	4
STAND2464	24	6	4
STAND121512	12	15	12
STAND123012	12	30	12
STAND243012	24	30	12
STAND242012	24	20	12

**DESCRIPTION MODEL PRICE**

**AC DIMMABLE DRIVERS (DAYBREAK)**



<b>DIMM121512</b>	452
<b>DIMM241512</b>	452

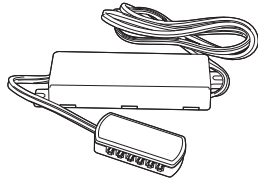

- Compatible with most standard wall dimmers.
- Drivers can be hard wired or used with included plug head. Multiple drivers can be used with a single wall dimmer switch and voltages can be mixed.

	Voltage	Wattage (Max Load)	Connector Ports
DIMM121512	12	15	12
DIMM241512	24	15	12

**INFRARED LIGHT SWITCH**



<b>IR1224</b>	112
---------------	-----

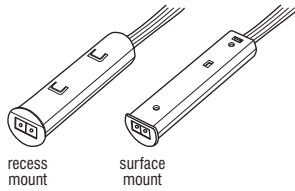

recess mount

surface mount

- Compatible with both 12V and 24V products.
- Can be installed inside or under a cabinet or recessed into moulding. Turns on and off by passing hand in front of it or when cabinet door is opened or closed.

**LIGHTING ACCESSORIES**

- LEDs are a solid state lighting source. LEDs are more efficient, durable, and safer than older light sources.

**POWER EXTENSION CABLE**



<b>CABL2500</b>	28
-----------------	----

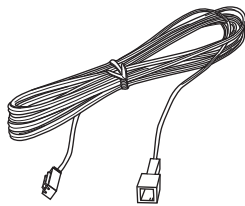

- Provides an additional 98.43" to reach those fixtures which are out of reach with the standard power leads.
- Features a male connector on one end and a female connector on the other.
- Compatible with PUCK18\_\_ and PUCK24\_\_.

**FLEX DRIVER CONNECTION LEAD**



<b>LEADDFLX2500</b>	15
---------------------	----

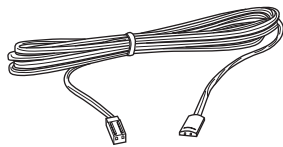

- Required part for each LED flexible strip series, connects the first LED flexible strip in the series to the driver.
- Lead length is 98".
- Compatible with FLEX12\_\_ and FLEX36\_\_.

**FLEX INTER CONNECTIONS**



<b>CONNFLXCRN50</b>	7
<b>LEADFLXIC500</b>	9
<b>LEADFLXIC1500</b>	18

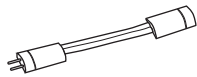

**CONNFLXCRN50**

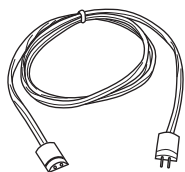

**LEADFLXIC500  
LEADFLXIC1500**

- Used with the LED flexible strips to connect strips together while allowing a gap between sections.
- CONNFLXCRN50 is 1.97" (50mm) and is recommended for the connection of two flexible strips around a corner.
- LEADFLXIC500 is 19.69" (500mm), suggested use is around small obstructions.
- LEADFLXIC1500 is 59" (1500mm), suggested use is around large appliances such as microwaves and refrigerators.
- Compatible with FLEX12\_\_ and FLEX36\_\_.

**DESCRIPTION MODEL PRICE**

**RIGID DRIVER CONNECTION CABLE**



<b>CABLRIGD2500</b>	17
---------------------	----

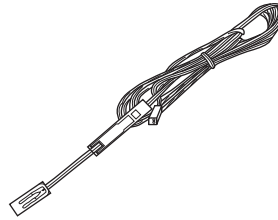

- Required to connect the first LED strip in a series to the driver.
- Cable length is 98".
- Compatible with RIGID12\_\_ and RIGID24\_\_.

**RIGID INTER CONNECTIONS**



<b>CABLRIGCRN30</b>	10
---------------------	----

<b>CABLRIGIC300</b>	7
---------------------	---

<b>LEADRIC1500</b>	11
--------------------	----

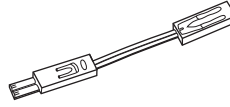

**CABLRIGCRN30**

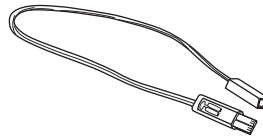

**CABLRIGIC300**

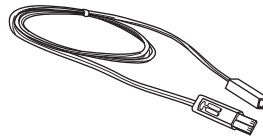

**LEADRIC1500**

- Used with the LED rigid strips to connect strips together while allowing a gap between sections.
- CABLRIGCRN30 is 1.18" (30mm) and is recommended for the connection of two rigid strips around a corner.
- CABLRIGIC300 is 11.81" (300mm).
- LEADRIC1500 is 59" (1500mm), suggested use is around large appliances such as microwaves and refrigerators.
- Compatible with RIGID12\_\_ and RIGID24\_\_.

**RIGID STRIP END CAP**



<b>ENDRIG</b>	1
---------------	---

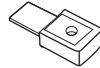

- Used to provide a clean and professional termination of the rigid strip light series.
- Compatible with RIGID12\_\_ and RIGID24\_\_.

**QUATTRO DIMMING RECEIVER**



<b>QDIMREC</b>	476
----------------	-----



- Wireless RF control for an easy, no wire installation.
- Unlimited receiver locations per zone.
- Up to 100' of wireless operation even through obstacles like walls.
- 256 levels of extra smooth dimming.
- Soft start On/Off for gradual dimming.

**QUATTRO WALL CONTROLLER**



<b>Q4ZONECON</b>	476
------------------	-----

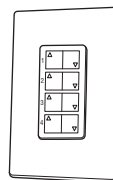

- Wireless RF control for an easy, no wire installation.
- Unlimited receiver locations per zone with Quattro Dimming Receiver.
- Detachable face for easy handheld remote operation and battery changing.
- Up to 100' of wireless operation even through obstacles like walls.
- Multiple switches per zone for easy 2, 3, or 4 way control.
- Can be ganged (grouped) with wall switches or outlets behind a single cover plate.
- Includes low cost, long life lithium 3V battery for up to 10 years of operation.

DESCRIPTION	MODEL	PRICE
<b>DECORATIVE HARDWARE - KNOBS &amp; PULLS</b>		

**ANTIQUPEWTER**



**NEW** **KNOBM148** 17  
 L: 2 5/8"  
 W: 5/8"  
 P: 1 1/4"



**NEW** **KNOBM206** 17  
 D: 1 1/4"  
 P: 1 1/16"



**NEW** **PULLM364** 21  
 C/C: 3"  
 L: 4 5/8"  
 W: 1 7/16"  
 P: 15/16"



**NEW** **PULLM475** 16  
 C/C: 3 3/4"  
 L: 5"  
 W: 9/16"  
 P: 1"

**BLACK**



**NEW** **KNOBT1017** 33  
 C/C: 1 1/4"  
 L: 2"  
 W: 11/16"  
 P: 1 1/4"  
 Pairs best with PULLT1015



**NEW** **PULLT1015** 47  
 C/C: 7"  
 L: 8"  
 W: 11/16"  
 P: 1 1/2"  
 Pairs best with KNOBT1017

**D** = Diameter  
**P** = Projection (Hardware Depth)  
**L** = Length  
**W** = Width  
**B** = Base  
**C/C** = Center to Center

Installation screws included with each hardware piece.  
 Larger pulls may not be compatible with 5-piece drawer fronts on face frame openings of 9" wide or less.  
 See page 82 for 5-piece drawer front dimensions when specifying decorative hardware.  
 For color images of decorative hardware, see [schrock.com/products/hardware](http://schrock.com/products/hardware).

DESCRIPTION	MODEL	PRICE
<b>BLACK (cont'd)</b>		



**NEW** **KNOB1912** 40  
 D: 1 1/4"  
 P: 1 13/16"



**NEW** **KNOBH951** 15  
 L: 1 3/4"  
 W: 1"  
 P: 1"  
 B: 1 1/16" x 1/2"



**NEW** **PULLH952** 29  
 C/C: 3"  
 L: 4 1/4"  
 W: 1 1/2"  
 P: 11/16"



**NEW** **PULLM383** 29  
 C/C: 5 1/16"  
 L: 6"  
 W: 1/2"  
 P: 1 1/16"

**BLACK IRON**



**NEW** **KNOB1901** 27  
 L: 1 7/16"  
 W: 1 1/4"  
 P: 1 1/8"  
 B: 15/16"



**NEW** **PULL1902** 39  
 C/C: 128mm  
 L: 6 1/3"  
 W: 1 1/10"  
 P: 1 1/16"

**BLACK MIST**







**NEW** **KNOBH116** 14  
 L: 1 5/16"  
 W: 1 1/4"  
 P: 1 1/8"  
 B: 3/8"





**NEW** **PULLH115** 30  
 C/C: 128mm  
 L: 6 3/8"  
 W: 1/2"  
 P: 1"







DESCRIPTION	MODEL	PRICE
<b>BLACKENED BRONZE</b> 		
	<b>NEW</b> <b>KNOBH136</b> L: 1 3/4" W: 1/2" P: 1 1/8" B: 1/2"	13
	<b>NEW</b> <b>PULLH130</b> C/C: 128mm L: 6 3/8" W: 7/16" P: 1 1/8"	15
	<b>NEW</b> <b>PULLH132</b> C/C: 224mm L: 10" W: 1/2" P: 1 3/8"	24





DESCRIPTION	MODEL	PRICE
<b>BRONZE HIGHLIGHT</b> 		
	<b>NEW</b> <b>KNOBRH20</b> L: 1 7/16" W: 1 7/16" P: 1 3/32"	36
	<b>NEW</b> <b>PULLRH21</b> C/C: 3" L: 4 39/64" W: 25/32" P: 1 3/16"	18



DESCRIPTION	MODEL	PRICE
<b>CAST IRON</b> 		
	<b>NEW</b> <b>KNOBM1820</b> L: 1 5/16" W: 1 5/16" P: 1"	36
	<b>NEW</b> <b>PULLM1823</b> C/C: 5 1/16" L: 7 3/8" W: 1" P: 1 1/4"	42

D = Diameter  
P = Projection (Hardware Depth)  
L = Length  
W = Width  
B = Base  
C/C = Center to Center

Installation screws included with each hardware piece.  
Larger pulls may not be compatible with 5-piece drawer fronts on face frame openings of 9" wide or less.  
See page 82 for 5-piece drawer front dimensions when specifying decorative hardware.  
For color images of decorative hardware, see [schrock.com/products/hardware](http://schrock.com/products/hardware).

DESCRIPTION	MODEL	PRICE
<b>CHAMPAGNE BRONZE</b> 		
	<b>NEW</b> <b>KNOB1909</b> L: 1 1/4" W: 1 1/4" P: 1 1/8" B: 3/4"	29
	<b>NEW</b> <b>PULL1910</b> C/C: 224mm L: 9 9/16" W: 3/4" P: 1 5/16"	61
	<b>NEW</b> <b>PULL1911</b> C/C: 192mm L: 8 3/8" W: 3/4" P: 1 1/4"	54

DESCRIPTION	MODEL	PRICE
<b>CHROME</b> 		
	<b>NEW</b> <b>KNOB1906</b> L: 1 1/16" W: 1 1/16" P: 1 1/8" B: 3/8"	40
	<b>NEW</b> <b>PULL1905</b> C/C: 128mm L: 6 3/8" W: 9/16" P: 1"	54
	<b>NEW</b> <b>PULL1904</b> C/C: 3 3/4" L: 5 1/4" W: 1" P: 1"	56

DESCRIPTION	MODEL	PRICE
<b>GOLD</b> 		
	<b>NEW</b> <b>KNOB1908</b> L: 1 1/4" W: 1 1/4" P: 1" B: 3/8"	30
	<b>NEW</b> <b>PULL1907</b> C/C: 160mm L: 6 7/10" W: 2/5" P: 1 1/5"	49

**DESCRIPTION MODEL PRICE**

**HAMMERED BRONZE**



**NEW** **KNOBH913** 35  
L: 1 3/8"  
W: 1 3/8"



**NEW** **PULLH911** 37  
C/C: 3"  
L: 5 5/8"  
W: 1"  
P: 1 1/4"

**ICE TEA**



**NEW** **KNOBH108** 10  
L: 1 7/16"  
W: 1 1/16"  
P: 1"  
B: 1/2"



**NEW** **PULLH144** 21  
C/C: 160mm  
L: 6 5/16"  
W: 9/16"  
P: 1 1/16"

**RUST**



**NEW** **KNOBM207** 17  
D: 1 1/4"  
P: 1 1/16"



**NEW** **PULLM476** 36  
C/C: 3 3/4"  
L: 5"  
W: 9/16"  
P: 1"

**D** = Diameter  
**P** = Projection (Hardware Depth)  
**L** = Length  
**W** = Width  
**B** = Base  
**C/C** = Center to Center

Installation screws included with each hardware piece.  
Larger pulls may not be compatible with 5-piece drawer fronts on face frame openings of 9" wide or less.  
See page 82 for 5-piece drawer front dimensions when specifying decorative hardware.  
For color images of decorative hardware, see [schrock.com/products/hardware](http://schrock.com/products/hardware).

**DESCRIPTION MODEL PRICE**

**SATIN NICKEL**



**NEW** **KNOBT002** 39  
C/C: 1 1/4"  
L: 2"  
W: 3/8"  
P: 1 1/2"  
Pairs best with PULLT001



**NEW** **PULLT001** 27  
C/C: 7"  
L: 8"  
W: 3/8"  
P: 1 1/2"  
Pairs best with KNOBT002



**NEW** **PULLH120** 25  
C/C: 160mm  
L: 7 1/8"  
W: 3/4"  
P: 1"  
Pairs best with PULLH122



**NEW** **PULLH122** 47  
C/C: 12"  
L: 12 3/4"  
W: 7/8"  
P: 1 3/16"  
Pairs best with PULLH120



**NEW** **PULLH105** 31  
C/C: 1"  
L: 1 3/4"  
W: 1"  
P: 1 3/4"  
Pairs best with PULLH106 or PULLH107



**NEW** **PULLH106** 44  
C/C: 160mm  
L: 7"  
W: 1"  
P: 1 3/4"  
Pairs best with PULLH105 or PULLH107









**NEW** **PULLH107** 70  
C/C: 12"  
L: 13"  
W: 1"  
P: 1 13/16"  
Pairs best with PULLH105 or PULLH106

DESCRIPTION	MODEL	PRICE
<b>SATIN NICKEL</b> (cont'd)		
	 <b>KNOB1420</b> D: 1 1/4" P: 1 1/8"	17
	 <b>KNOBH100</b> D: 1 3/8" P: 1 3/8" B: 3/4"	17
	 <b>KNOBH118</b> L: 1 5/16" W: 1 5/16" P: 1 3/16" B: 7/8"	15
	 <b>KNOBM549</b> D: 7/8" P: 1"	16
	<b>PULLH50</b> C/C: 5" L: 5" W: 5/16" P: 1 1/4"	46
	<b>PULLH63</b> C/C: 96mm L: 4 1/8" W: 1/2" P: 1 1/16"	39
	 <b>PULLH957</b> C/C: 3" L: 4 1/4" W: 1 1/2" P: 1 1/16"	26

D = Diameter  
P = Projection (Hardware Depth)  
L = Length  
W = Width  
B = Base  
C/C = Center to Center

Installation screws included with each hardware piece.  
Larger pulls may not be compatible with 5-piece drawer fronts on face frame openings of 9" wide or less.  
See page 82 for 5-piece drawer front dimensions when specifying decorative hardware.  
For color images of decorative hardware, see [schrock.com/products/hardware](http://schrock.com/products/hardware).

DESCRIPTION	MODEL	PRICE
<b>SATIN NICKEL</b> (cont'd)		
	 <b>PULLM381</b> C/C: 5 1/16" L: 6" W: 1/2" P: 1 1/16"	21
	 <b>PULLM430</b> C/C: 5 1/16" L: 7" W: 15/32" P: 1 7/16"	25
	 <b>PULLM570</b> C/C: 5 1/16" L: 5 7/8" W: 1/2" P: 1 3/16"	20
<b>SILVER STONE</b>		
	 <b>KNOBH127</b> D: 1 1/2" P: 1" B: 7/8"	17
	 <b>PULLH128</b> C/C: 160mm L: 7 1/2" W: 3/4" P: 1 1/16"	27

DESCRIPTION	MODEL	PRICE
<b>STAINLESS STEEL</b>		
	<b>NEW</b> <b>KNOBH135</b> L: 1 3/4" W: 1/2" P: 1 1/8" B: 1/2" Pairs best with PULLH129 or PULLH131	13
	<b>NEW</b> <b>PULLH129</b> C/C: 128mm L: 6 3/8" W: 7/16" P: 1 1/8" Pairs best with KNOBH135 or PULLH131	15
	<b>NEW</b> <b>PULLH131</b> C/C: 224mm L: 10" W: 1/2" P: 1 3/8" Pairs best with KNOBH135 or PULLH129	23
	<b>NEW</b> <b>PULLH141</b> C/C: 128mm L: 7 3/8" W: 1/2" P: 1 1/4" Pairs best with PULLH142 or PULLH143	14
	<b>NEW</b> <b>PULLH142</b> C/C: 192mm L: 9 15/16" W: 1/2" P: 1 1/4" Pairs best with PULLH141 or PULLH143	16
	<b>NEW</b> <b>PULLH143</b> C/C: 384mm L: 17 1/2" W: 1/2" P: 1 1/4" Pairs best with PULLH141 or PULLH142	24

DESCRIPTION	MODEL	PRICE
<b>TUSCAN BRONZE</b>		
	<b>NEW</b> <b>KNOBH117</b> L: 1 5/16" W: 1 5/16" P: 1 3/16" B: 7/8" Pairs best with PULLH119	15
	<b>NEW</b> <b>PULLH119</b> C/C: 160mm L: 7 1/8" W: 3/4" P: 1" Pairs best with KNOBH117	37
	<b>NEW</b> <b>KNOBT013</b> D: 1 1/4" P: 1 1/16"	31
	<b>NEW</b> <b>PULLM1674</b> C/C: 3" L: 4 5/8" W: 1 7/16" P: 15/16"	43
	<b>NEW</b> <b>PULLT018</b> C/C: 5 1/16" L: 6" W: 1/2" P: 1 1/16"	29

D = Diameter  
P = Projection (Hardware Depth)  
L = Length  
W = Width  
B = Base  
C/C = Center to Center

Installation screws included with each hardware piece.  
Larger pulls may not be compatible with 5-piece drawer fronts on face frame openings of 9" wide or less.  
See page 82 for 5-piece drawer front dimensions when specifying decorative hardware.  
For color images of decorative hardware, see [schrock.com/products/hardware](http://schrock.com/products/hardware).

DESCRIPTION	MODEL	PRICE
-------------	-------	-------

**DECORATIVE HARDWARE - FAUX HINGES**

- Faux Strap Hinge: All 12" - 30" high doors use 2 hinges. All 36" high and above use 3 hinges.
- Faux Barrel Hinge: All 12" - 30" high doors use 2 hinges. All 42" high and above use 3 hinges.
- Requires field installation.
- For use with Brantley door style.

**BRONZE HIGHLIGHT**



**HINGEFH1** 10  
 Antique Brass Faux Barrel Hinge  
 Pairs best with the following hardware finishes:  
 Black Iron  
 Blackened Bronze  
 Bronze Highlight  
 Cast Iron  
 Champagne Bronze  
 Hammered Bronze  
 Ice Tea  
 Rust  
 Silver Stone  
 Tuscan Bronze

**PEWTER**



**HINGEFH2** 10  
 Pewter Faux Barrel Hinge  
 Pairs best with the following hardware finishes:  
 Antique Pewter  
 Black  
 Black Mist  
 Blackened Bronze  
 Chrome

**BLACK**



**HINGEFH3** 10  
 Black Faux Strap Hinge  
 Pairs best with the following hardware finishes:  
 Antique Pewter  
 Black  
 Black Iron  
 Black Mist  
 Blackened Bronze  
 Bronze Highlight  
 Cast Iron  
 Champagne Bronze  
 Chrome  
 Hammered Bronze  
 Ice Tea  
 Rust  
 Satin Nickel  
 Silver Stone  
 Stainless Steel



**DESCRIPTION MODEL PRICE**

**COOKING UTENSIL DIVIDER**



<b>CUDD24</b>	262
<b>CUDD30</b>	293
<b>CUDD36</b>	323

- Pre-assembled natural wood drawer insert (does not fit roll trays).

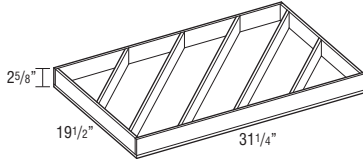
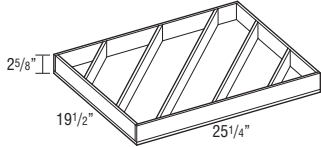
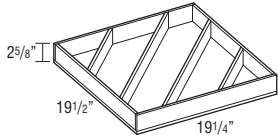

**CUTLERY INSERT WOOD ORGANIZER**



<b>CIW15</b>	182
<b>CIW18</b>	195
<b>CIW21</b>	252
<b>CIW24</b>	270

Model	Application
CIW15	15" Base
CIW18	18" Base
CIW21	21" Base
CIW24	24" Base

- Pre-assembled natural wood drawer insert.
- CIW also available installed in B\_\_\_CIW, B\_\_\_RTCIW, and 4DB\_\_\_CIW. See pages 236, 260, and 316.
- Place a cabinet with a CIW next to the dishwasher for convenience.

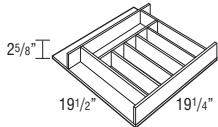
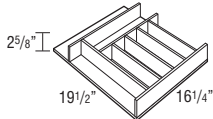
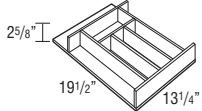
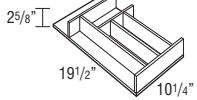

**DESCRIPTION MODEL PRICE**

**WOOD TIERED CUTLERY DIVIDER DRAWER**



<b>WTCD15</b>	486
<b>WTCD18</b>	505
<b>WTCD21</b>	525
<b>WTCD24</b>	542
<b>WTCD30</b>	710
<b>WTCD36</b>	747

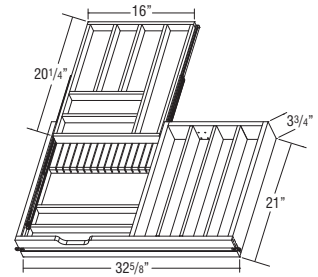
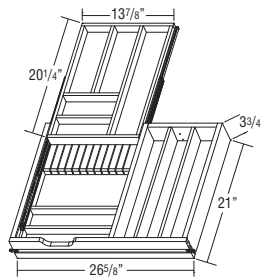
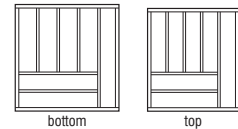
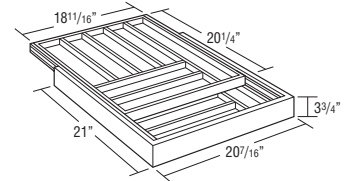
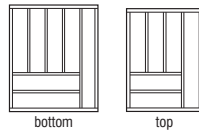
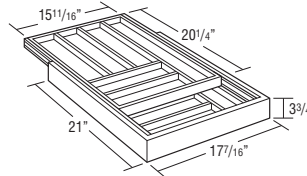
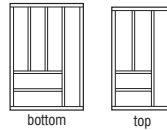
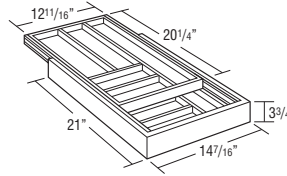
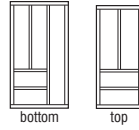
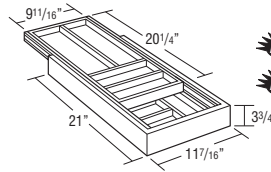

Model	Application
WTCD15	15" Base
WTCD18	18" Base
WTCD21	21" Base
WTCD24	24" Base
WTCD30	30" Base
WTCD36	36" Base

- Replaces standard drawer. Uses existing cabinet member drawer hardware.
- Requires field installation of drawer front.
- For use with 24" deep cabinets only.
- Exterior WTCD drawer box height is 3 3/4", interior height of top and bottom tier is 1 3/8".
- Top divider slides front-to-back.



DESCRIPTION	MODEL	PRICE
-------------	-------	-------

**WOOD TIERED K-CUP\* DRAWER**

**KCUP18**

**505**

- Holds 40 K-Cups.
  - Exterior Wood Tiered K-Cup drawer box height is 3 3/4", interior height of top tier is 1 5/8", and interior height of bottom tier is 1 3/8".
  - The Wood Tiered K-Cup Drawer is compatible with K-Cup pods only.
  - Replaces standard drawer. Uses existing cabinet member drawer hardware.
  - Requires field installation of drawer front.
  - Only for use with 24" deep cabinets that are 18" wide or have a 15" wide frame opening for the drawer.
  - Top divider slides front-to-back.
- \*K-Cup is a registered trademark of Keurig Green Mountain, Inc.

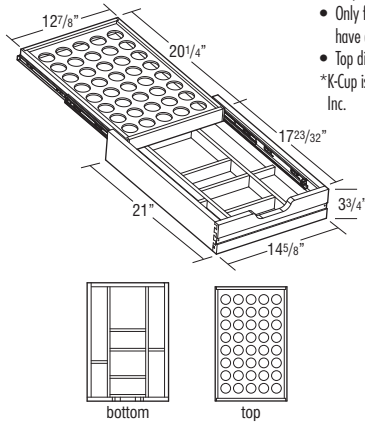

**EDGEBANDING**



**EDGEBAND1OWD**

**41**

**EDGEBAND1OP**

**41**

**EDGEBAND1ONML**

**41**

**EDGEBAND1ONIP**

**41**

**EDGEBAND1OWHL**

**41**

- Edgebanding will come in a 10' length. Recommended for use on panels 3/4" thick or less, edgebanding width will need to be field-trimmed.
- Finger joints may be visible on unfinished veneer and clear coated edgebanding.
- Edgebanding does not come pre-glued.
- EDGEBAND1OWD is unfinished veneer, available in Alder, Cherry, Maple, Oak, Rustic Alder, and Rustic Hickory.
- EDGEBAND1OP is available in Arctic, Antler, Elk, Gunstock, High Gloss White, High Gloss White with Metallic, Icy Avalanche Linea Nightfall, Obsidian, and Wharf.
- EDGEBAND1ONML is Natural Maple Laminate.
- EDGEBAND1ONIP is clear coated veneer for use with APC natural interiors.
- EDGEBAND1OWHL is White Laminate.

**ANGLED HEAT SHIELDS**



**ANGLHEATSHIELD**

**147**

**ANGLSHIELDSS**

**167**

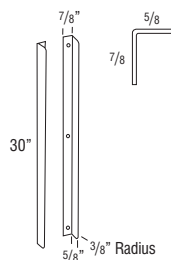

- ANGLHEATSHIELD is a pair of 1/16" thick, white powder coated metal shields.
- ANGLSHIELDSS is a pair of 1/16" thick, stainless steel metal shields.
- Heat Shield is used to deflect heat from self-cleaning ovens away from cabinet doors and drawer fronts.
- For use when additional 1/8" cannot be added to the oven manufacturer's recommended space requirement.
- Cabinet door cannot be hinged on the same side as the angled heat shield, not compatible with double door cabinets. Installs on the front of the face frame of each cabinet adjacent to the oven.

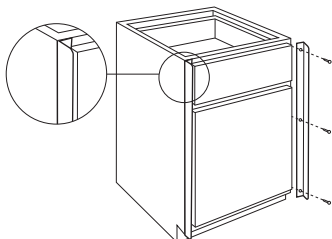

**STRAIGHT HEAT SHIELDS**



**MODEL**

**PRICE**

**STRTHEATSHIELD**

**108**

**STRTHSHIELDSS**

**129**

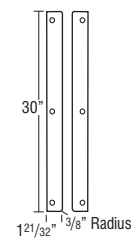

- STRTHEATSHIELD is a pair of 1/16" thick, white powder coated metal shields.
- STRTHSHIELDSS is a pair of 1/16" thick, stainless steel metal shields.
- Heat Shield is used to deflect heat from self-cleaning ovens away from cabinet doors and drawer fronts.
- For use when additional 1/8" can be added to the oven manufacturer's recommended space requirement.
- Installs on the side of the face frame of each cabinet adjacent to the oven.

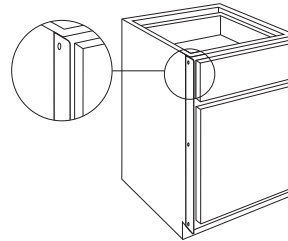

**K-CUP\* INSERT**

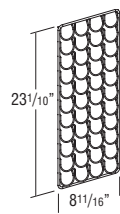

**WBCPOKUP**

**123**

- Holds 44 K-Cups, compatible with K-Cup pods only.
  - Wire K-Cup rack for easy field installation on either the left or right side. Compatible with all heights of 3" wide box column pull-outs (WBCPO., see page 186). Depending on height of pull-out, shelves can be used above or below insert for additional storage: 30" and 33" high include 4 shelves, not compatible with insert. 36" and 39" high include 5 shelves, one shelf recommended for use with insert. 42" high includes 6 shelves, two shelves recommended for use with insert.
- \*K-Cup is a registered trademark of Keurig Green Mountain, Inc.

**LID ORGANIZERS**



**LO24DPRT30**

**441**

**LO24DPRT33**

**466**

**LO24DPRT36**

**488**

**LO**

**306**

- LO24DPRT30, LO24DPRT33, and LO24DPRT36 include roll tray and installation hardware.



**LINEN CLOSET HAMPER LINER**



**LCHAMPERLNR**

**110**

- Replacement cloth liner for use with LCRH188421, see page 498.





DESCRIPTION	MODEL	PRICE
OVEN INSTALLATION KIT	OCINSTALLKIT	59

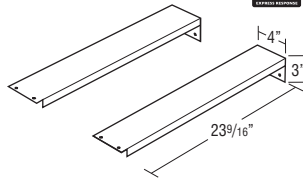

- Recommended for supporting built-in appliances such as ovens, microwaves, and warming drawers. Refer to appliance manufacturer specifications for installation requirements.
- Weight limit is 400 lbs. per pair.

DESCRIPTION	MODEL	PRICE
PEGGED DISH ORGANIZER	PDO (8 Posts & Board)	377
	PDOPOSTS (4 Posts)	96

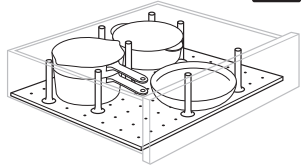

- For use in 36" wide drawer base cabinets in 6 3/8" or 10" deep drawers, trimmable for cabinets less than 36" wide. Not recommended for use in roll trays.
- Pegged Board is 19/32" thick.
- 29 15/16" x 19 1/2".
- Posts are 6" high.

DESCRIPTION	MODEL	PRICE
POTS & PANS PULL-OUT	PPP	939
	PPP30	1302

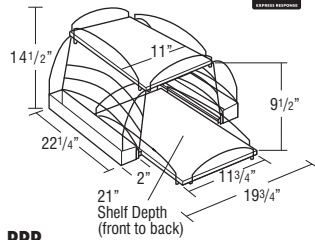

- For use in 24" wide cabinets.

**PPP30** 1302

- For use in 30" wide cabinets.

DESCRIPTION	MODEL	PRICE
POTS & PANS PULL-OUT	PPP30	1302

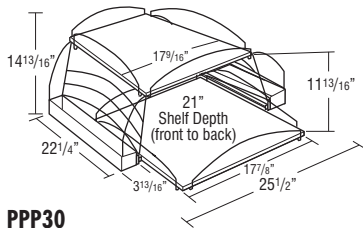

**PPP30** 1302

DESCRIPTION	MODEL	PRICE
POWERGLIDE™ COMPACT DRAWER OUTLET	DRWPWR1	480

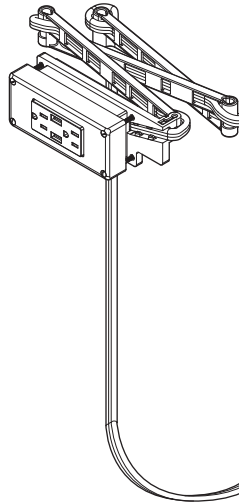

- Outlet has a total rated capacity of 15 amps.
- Includes two 120V electrical plug-ins and two 2.1 amp rated USB charging ports.
- Cord has 3 ft. of length hanging freely from back mounting bracket. The cord is 14 gauge wire and features a standard 3-prong plug and is required to be plugged into an approved AFCI/GFCI dual function outlet for all applications.
- Outlet is ETL approved-compliant for electrical and other safety standards to U.S. and Canadian safety including UL standards.
- Requires field installation including a 4.25" x 2.13" square hole to be cut into the back of the drawer box.
- Outlet face plate measures 5.22" x 2.3" and will extend 3/4" into drawer box.
- A minimum drawer box height of 2 5/8" is required for installation.
- For use in base cabinet widths of 18" to 36".
- For use in cabinet depths of 15", 18", 21", and 24".
- Also available as an installed modification, see DRWPWR on page 54.

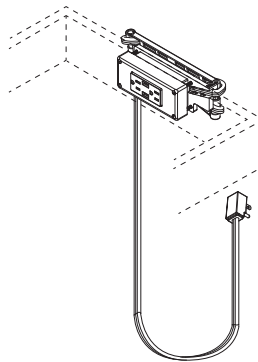

DESCRIPTION	MODEL	PRICE
POWER POD	JPWRPODBK (Black)	623
	JPWRPODSS (Stainless Steel)	890
	JPWRPODGM (Gun Metal Black)	890

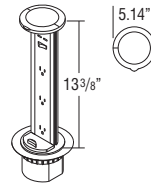

- Includes: independent power switch, three electrical sockets, and two USB ports (located above power switch).
- 18" of clearance required below surface mount location; and 3 9/16" diameter hole is required in countertop to install.
- This item requires field installation. This accessory cannot be installed above drawers.
- Safe for countertop installation: rated IP54-splash proof from splashing water and water jets per IPX waterproof specifications; and is ETL approved-compliant for electrical and other safety standards to North America safety including: UL, ANSI, CSA, ASTM, and NFPA standards.
- When installed, top lip of strip sits on top of countertop with a pivoting handle. Handle is pulled up to bring bottom of power strip to countertop.
- Cord is 8 ft. long and features a standard 3-prong plug for use in any household outlet. 10 amps.

DESCRIPTION	MODEL	PRICE
SINK BASE CADDY	SBCADDY	511

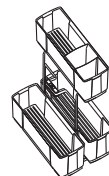

- Caddy is removable and portable.
- Recommended for use in cabinets 18" and wider.
- Caddy dimensions are: 9 15/16" wide x 18 5/16" tall x 18 5/8" deep.
- Caddy fits in cabinets with a minimum: 12" wide x 20 1/2" high frame opening x 21" deep cabinet.

**DESCRIPTION MODEL PRICE**

**SLIDING TOWEL RACK**



**STR**

**137**

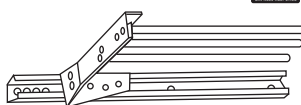

- Metal.
- 5" wide x 17 3/4" long x 1 1/2" high.
- Fits in any sink cabinet.

**EZ-ORG™ MODULAR PULL-OUT RACKS**



**EZORG18**

**500**

**EZORG24**

**665**

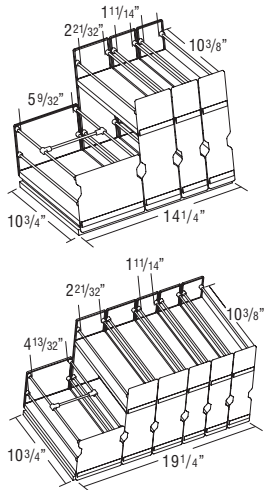

- EZORG18 includes four pull-out racks installed onto a wood base for use in an 18" wide or wider cabinet. Outside rack dimensions: one 5 7/8" wide x 5 3/4" high, one 3 1/4" wide x 10 3/4" high, two 2 3/8" wide x 10 3/8" high.
- EZORG24 includes six pull-out racks installed onto a wood base for use in a 24" wide or wider cabinet. Outside rack dimensions: one 5" wide x 5 3/8" high, two 3 1/4" wide x 10 3/4" high, three 2 3/8" wide x 10 3/8" high.
- Entire pull-out must be installed as one unit, cannot remove racks from wood base for individual installation.
- Racks feature natural finish wood shelves with wire racks and frosted front and back panels. Guides are full extension and do not feature Smart Stop.
- Maximum Weight Capacity: 2 3/8" and 3 1/4" wide racks: 7 lbs. 5" and 5 7/8" wide racks: 20 lbs.
- Must be installed on the floor of the cabinet. Cannot be installed on an adjustable shelf.
- Field installation requires attaching wood base to cabinet bottom with pre-drilled mounting holes, includes 4 screws and instructions.
- Installation height clearance of 12" minimum is recommended.

**SPICE RACKS**



**SRCH12**

**120**

**SRCH15**

**135**

**SRCH18**

**147**

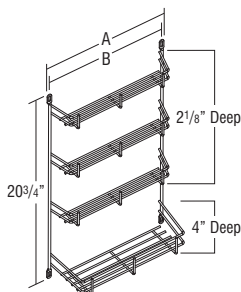

- A = Hole Centers Width**  
**B = Outside Overall Widths**
- Designed for Base cabinets only. Mounts to door top and bottom rails.
  - Spice Rack is chrome.

Model	A	B	Fits
SRCH12	7 7/8"	8 13/50"	B15, B30, B33
SRCH15	10 5/8"	11"	B18, B36
SRCH18	13 5/8"	14"	B21, B24 L or R

**SPICE RACK PULL-DOWN**



**SPD18**

**227**

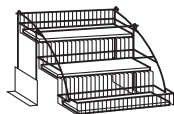

- Spice Rack Pull-down dimensions: 8 15/16" high x 14 13/16" wide x 10 5/16" deep.
- Extends 3 3/4" below and 9 1/4" in front of the cabinet box when fully extended.
- Maximum Weight Capacity: 15 lbs.
- Must be installed on the floor of the cabinet. Cannot be installed on an adjustable shelf.

**SHELF PULL-DOWN**



**SHLFPD36**

**1375**

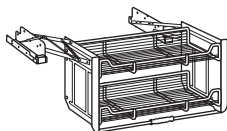

- Shelf Pull-down dimensions: 18 11/64" high x 28 1/4" wide x 8 1/2" deep.
- Clearance dimensions: 19 3/8" high x 15 3/8" wide.
- Maximum Weight Capacity: 26 lbs.
- Must be installed on the floor of the cabinet. Cannot be installed on an adjustable shelf.

**DESCRIPTION MODEL PRICE**

**TABLET HOLDER**



**TABLEHLDR**

**240**

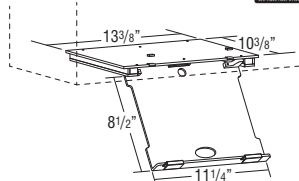

- Mounts under 15" wide cabinet or wider.
- Designed for cabinets 12" deep or deeper.
- Features an acrylic mounting base and pull-down tablet holder tray.
- Tray is movable forward and backward with a slight side to side rotation, and can be utilized at any position.
- Tray has side cut-outs for a charging cord and can be used to store most tablets when closed, depending on overall thickness, width, height, and weight of the tablet.
- Maximum dimensions for tablet: 11 1/4" x 8 1/2" x 1 1/8" thick. Maximum tablet weight is 3 1/2 lbs.
- Tablet Holder has an overall height of 1 17/32" when installed and in closed position (measured from the bottom panel of the cabinet), 0.78" visible from front of cabinet when closed.
- Installation instructions included.

**TOEKICK VACUUM**



**TOEKICKVAC**

**600**

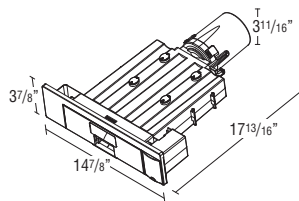

- 120V compact vacuum cleaner for field installation into the toekick area of base cabinets. Toekick area must be routed for vacuum to be inserted and screwed into place.
- Flooring installation must be compatible with the vacuum by ensuring the bottom of the cabinet is flush with the top of the flooring to allow clearance for the tray to open to access the bag and filter. The flooring should either be installed under the cabinets or the cabinets can be raised to the flooring level.
- Vacuum is 120V-60Hz, rated current of 5 amps, and rated input power is 650W.
- Cord is 10 ft. from the right side of the unit and features a standard 3-prong plug for use in any household outlet.
- Built-in switch can be gently tapped to turn the unit on, a 10 second timer will automatically turn the unit off.
- Should not be installed in a sink base, bathroom, outdoors, or in other wet environments. Do not expose to moisture, rain, or snow. Do not pick up water or sweep water into the vacuum.
- For installation in the front toekick, cabinet must have a minimum depth of 22" and a minimum width of 18". For installation in an end panel, cabinet must have a minimum depth of 21" and a minimum width of 21".
- TOEKICKVAC includes one reusable 0.5 gallon vacuum bag, one HEPA filter, and 4 disposable bags.
- Plastic faceplate features a stainless steel look.
- An air exhaust opening equal to 8" sq (50 cm sq) is required in an area adjacent to the TOEKICKVAC at the rear or side of the cabinet, where cabinets are tight to the floor.

**DESCRIPTION MODEL PRICE**

**TILT-OUT TRAYS, PLASTIC**



<b>TOT15</b>	116
<b>TOT18</b>	121

- Kit includes two white plastic trays and one pair of tilt-out hinges that attaches to the inside of the false panel.
- One tilt-out tray per false panel on cabinets less than 30" wide and greater than 36" wide, two tilt-out trays attached to one false panel on 30"-36" wide cabinets.
- Clean using a mild soap and water. Avoid scalding water.

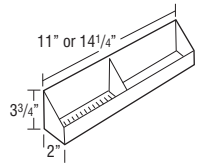

Model	Width	Application
TOT15	11"	SB30, SB33
TOT18	14 1/4"	SB36, SB39, SB42, SB24, SB27, SB48

**TILT-OUT TRAYS, STAINLESS STEEL SLIM**



<b>TOTSSS10</b>	274
<b>TOTSSS13</b>	274
<b>TOTSSS16</b>	274
<b>TOTSSS19</b>	274
<b>TOTSSS25</b>	274
<b>TOTSSS31</b>	274

- Contains one tray and one pair of tilt-out hinges that attaches to the inside of the false panel.
- One tilt-out tray per false panel.
- Tray is 1 11/16" deep and protrudes 3/4" into cabinet.

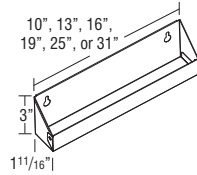

Model	Width	Application
TOTSSS10	10"	ACS36, VSB15, VACSF
TOTSSS13	13"	SB39, ACS39, VSB18, VSB39, 2VSD36, 2VSD42, 2VSD48, VSD60, 6VSD42FP
TOTSSS16	16"	SB21, SB42, SB45, VSB21, VSB42, VSB45, 2VSD45, VSD54FP, VSD60FP, VS3D54, VS3D60
TOTSSS19	19"	SB24, SB27, SB48, ACS42, VSB24, VSB27, VSB48, VSB54, 2VSD54, 2VSD60, VSD24FP, VSD27FP, 6VSD48FP, 6VSD54FP, 6VSD57FP, 6VSD60FP, 8VSD48FP, 8VSD60FP
TOTSSS25	25"	SB30, SB33, VSB30, VSB33, VSB60, VSD30FP, VSD33FP, VSD42FP, VSD45FP
TOTSSS31	31"	SB36, VSB36, VSD36FP, VSD48FP

**TRAY DIVIDER, CHROME**



<b>CTDK</b>	57
-------------	----

- CTDK: Includes 1 divider, 3 clips, and 3 screws.
- Tray divider is chrome wire.

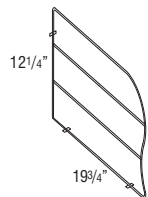

**DESCRIPTION MODEL PRICE**

**TRAY DIVIDER KIT**



<b>TDKIT15</b>	186
<b>TDKIT18</b>	186
<b>TDKIT21</b>	186
<b>TDKIT24</b>	186
<b>TDKIT27</b>	186

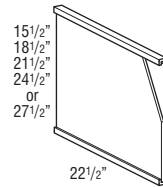

- Cabinets need full top and bottom for field installation of tray divider kits.
- Dividers are sized for a 24" deep cabinet, depth can be modified during field installation. Installation screws included.
- Tray dividers are Natural Maple laminated plywood. When specified with APC, tray dividers are clear coated veneer plywood. When specified with APC and WLI, dividers are white laminated plywood. Rails are always Natural Maple.

Model	Application	Wall Cabinets	Tall Cabinets — Upper Section
TDKIT15	Fits 15" high frame opening	Most 18" high wall cabinets	Upper section of 84" high utility, oven cabinets with 15" high frame opening
TDKIT18	Fits 18" high frame opening	Most 21" high wall cabinets	Upper section of 87" high utility, oven cabinets with 18" high frame opening
TDKIT21	Fits 21" high frame opening	Most 24" high wall cabinets	Upper section of 90" high utility, oven cabinets with 21" high frame opening
TDKIT24	Fits 24" high frame opening	Most 27" high wall cabinets	Upper section of 93" high utility, oven cabinets with 24" high frame opening
TDKIT27	Fits 27" high frame opening	Most 30" high wall cabinets	Upper section of 96" high utility, oven cabinets with 27" high frame opening

**TRAY DIVIDER ROLL-OUT KIT**



<b>TDRO12</b>	306
<b>TDRO15</b>	343

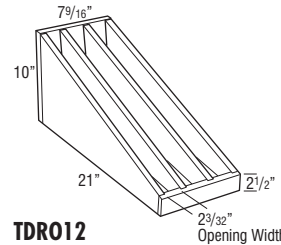

**TDRO12**

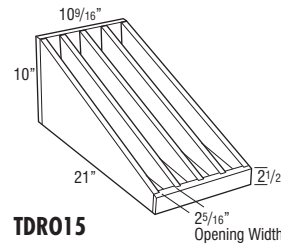

**TDRO15**

- TDRO12: 2 removable dividers (3 compartments).
- TDRO15: 3 removable dividers (4 compartments).
- Utilizes Smart Stop undermount guides and bumpers for door protection.
- Installation hardware included.

**VANITY CHROME ROLL-OUT RACK**



<b>VCRR1521</b>	242
<b>VCRR1821</b>	261

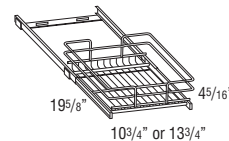

- Requires installation to fixed shelf or cabinet bottom in a 21" or 24" deep cabinet.
- VCRR1521 recommended for use in VB153221, VB153421, DDO152921.
- VCRR1821 recommended for use in VB183421, 2VSD363221, 2VSD363421, VSD303121, VSD303421, LC188421 (lower section), VU188421, VU188421H, DDO182921.
- Roll-out is full extension.

**DESCRIPTION**

**MODEL**

**PRICE**

**VANITY WASTEBASKET KIT**



**VWB**

354



- Bottom mount zinc colored Smart Stop guide with 20 quart gray wastebasket inserted in chrome support.
- Dimension of insert: 8.5" wide x 16.7" tall x 17.7" deep.

**WALL SUSAN KITS**



**WSK30**

306

**WSK33**

306

**WSK36**

400

**WSK39**

440

**WSK42**

474

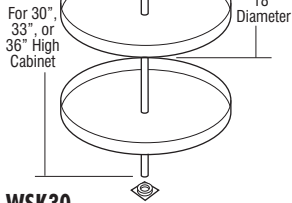

- 30"-36" kits include pole and two 18" diameter plywood shelves. 39" and 42" kits include pole and three 18" diameter plywood shelves.

**WSK30  
WSK33  
WSK36**

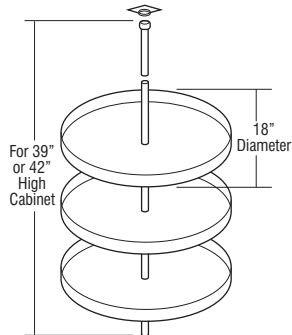

**WSK39  
WSK42**

**WINE GLASS HOLDERS**

**WGH30 (7 slots)**

302

**WGH33 (7 slots)**

344

**WGH36 (8 slots)**

372

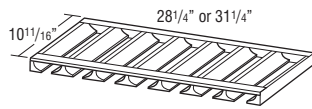

- Maximum wine glass base is 3" diameter.
- Wine Glass Holder is finished.
- May be trimmed to fit smaller cabinets.
- Designed for installation under a wall cabinet (between end panels and behind face frame).

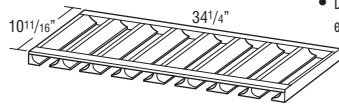

**Species Availability (Wood)**

Alder	Rustic Alder	Cherry	Rustic Hickory	Maple	Oak
•	Alder	•	Hickory	•	•

**Species Availability (All Laminates)**

High Glass	Horiz. Grain on Maple	Vert. Grain on Maple	Vert. Grain on Cherry	Vert. Grain on Oak
box color	box color	box color	box color	box color

**DESCRIPTION MODEL PRICE**  
**ROLL TRAY KITS**

**ROLL TRAY KIT**

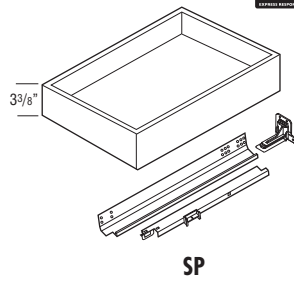

For 18" Deep Cabinets	
RT1218SP	388
RT1518SP	388
RT1818SP	390
RT2118SP	404
RT2418SP	406
RT2718SP	420
RT3018SP	429
RT3318SP	436
RT3618SP	440
RT3918SP	390
RT4218SP	404
RT4518SP	404
RT4818SP	406
For 21" Deep Cabinets	
RT1221SP	388
RT1521SP	388
RT1821SP	390
RT2121SP	404
RT2421SP	406
RT2721SP	420
RT3021SP	429
RT3321SP	436
RT3621SP	440
RT3921SP	390
RT4221SP	404
RT4521SP	404
RT4821SP	406
For 24" Deep Cabinets	
RT12SP	388
RT15SP	388
RT18SP	390
RT21SP	404
RT24SP	406
RT27SP	420
RT30SP	429
RT33SP	436
RT36SP	440
RT39SP	390
RT42SP	404
RT45SP	404
RT48SP	406

- RT\_\_SP's include roll tray, roll tray brackets, hardware, screws, and installation instructions.
- 39"-48" wide Roll Tray Kits will contain 1 roll tray. QTY of 2 must be ordered to achieve a roll tray in both cabinet openings.

**Custom Modifications**

ID	RD
	•

**DESCRIPTION MODEL PRICE**

**DEEP ROLL TRAY KIT**

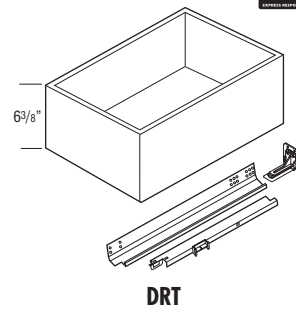

For 18" Deep Cabinets	
DRT1218	425
DRT1518	425
DRT1818	427
DRT2118	437
DRT2418	440
DRT2718	454
DRT3018	463
DRT3318	471
DRT3618	475
DRT3918	427
DRT4218	437
DRT4518	437
DRT4818	440
For 21" Deep Cabinets	
DRT1221	425
DRT1521	425
DRT1821	427
DRT2121	437
DRT2421	440
DRT2721	454
DRT3021	463
DRT3321	471
DRT3621	475
DRT3921	427
DRT4221	437
DRT4521	437
DRT4821	440
For 24" Deep Cabinets	
DRT12	425
DRT15	425
DRT18	427
DRT21	437
DRT24	440
DRT27	454
DRT30	463
DRT33	471
DRT36	475
DRT39	427
DRT42	437
DRT45	437
DRT48	440

- DRT\_\_'s include deep roll tray, deep roll tray brackets, hardware, screws, and installation instructions.
- 39"-48" wide Deep Roll Tray Kits will contain 1 roll tray. QTY of 2 must be ordered to achieve a roll tray in both cabinet openings.

**Custom Modifications**

ID	RD
	•

**DESCRIPTION**

**MODEL**

**PRICE**

**ROLL TRAY KIT – EASYTRAX™**



For 18" Deep Cabinets

RT1518ET	388
RT1818ET	390
RT2118ET	404
RT2418ET	406
RT2718ET	420
RT3018ET	429
RT3318ET	436
RT3618ET	440
RT3918ET	390
RT4218ET	404
RT4518ET	404
RT4818ET	406

For 21" Deep Cabinets

RT1521ET	388
RT1821ET	390
RT2121ET	404
RT2421ET	406
RT2721ET	420
RT3021ET	429
RT3321ET	436
RT3621ET	440
RT3921ET	390
RT4221ET	404
RT4521ET	404
RT4821ET	406

For 24" Deep Cabinets

RT15ET	388
RT18ET	390
RT21ET	404
RT24ET	406
RT27ET	420
RT30ET	429
RT33ET	436
RT36ET	440
RT39ET	390
RT42ET	404
RT45ET	404
RT48ET	406

- EasyTrax™ uprights are required, must be purchased separately (see page 588).
- RT-ET's contain roll tray, hardware, wooden hardware mounting bracket, screws and installation instructions.
- 39"-48" wide Roll Tray Kits will contain 1 roll tray. QTY of 2 must be ordered to achieve a roll tray in both cabinet openings.

**Custom Modifications**

ID	RD
	•

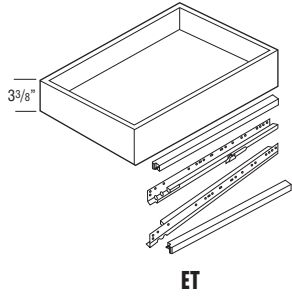

**DESCRIPTION**

**MODEL**

**PRICE**

**DEEP ROLL TRAY KIT – EASYTRAX™**



For 18" Deep Cabinets

DRT1218ET	425
DRT1518ET	424
DRT1818ET	426
DRT2118ET	437
DRT2418ET	440
DRT2718ET	454
DRT3018ET	463
DRT3318ET	471
DRT3618ET	474
DRT3918ET	426
DRT4218ET	437
DRT4518ET	437
DRT4818ET	440

For 21" Deep Cabinets

DRT1221ET	425
DRT1521ET	424
DRT1821ET	426
DRT2121ET	437
DRT2421ET	440
DRT2721ET	454
DRT3021ET	463
DRT3321ET	471
DRT3621ET	474
DRT3921ET	426
DRT4221ET	437
DRT4521ET	437
DRT4821ET	440



For 24" Deep Cabinets

DRT12ET	425
DRT15ET	425
DRT18ET	427
DRT21ET	437
DRT24ET	440
DRT27ET	454
DRT30ET	463
DRT33ET	471
DRT36ET	475
DRT39ET	427
DRT42ET	437
DRT45ET	437
DRT48ET	440

- EasyTrax™ uprights are required, must be purchased separately (see page 588).
- DRT-ET's contain roll tray, hardware, wooden hardware mounting bracket, screws and installation instructions.
- 39"-48" wide Deep Roll Tray Kits will contain 1 roll tray. QTY of 2 must be ordered to achieve a roll tray in both cabinet openings.

**Custom Modifications**

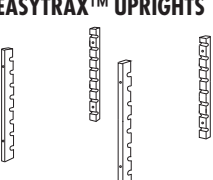
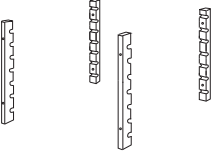
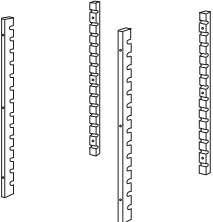
ID	RD
	•

DESCRIPTION	MODEL	PRICE
<b>EASYTRAX™ UPRIGHTS</b> 	<b>ETUPRIGHT</b>	182
	<b>ETUPRIGHTOV</b>	178
	<b>ETUPRIGHT40.5</b>	207
	<b>ETUPRCS</b>	10
	<b>ETUPR40.5CS</b>	10
<b>ETUPRIGHT</b> 	<ul style="list-style-type: none"> <li>EasyTrax™ system allows quick field installation of adjustable height roll trays with front and rear uprights to support roll tray guides.</li> <li>ETUPRIGHT contains 2 front and 2 rear uprights. QTY required: Base, Base Full Height, and 34 1/2" high Vanities = 1 Utility Cabinets = 3 42" and 48" wide cabinets = 2.</li> <li>ETUPRIGHTOV contains 2 front and 2 rear uprights. QTY required: Desk and 32" high Vanity = 1.</li> <li>ETUPRIGHT40.5 contains 2 front and 2 rear uprights. QTY required: 40 1/2" high Base cabinets = 1.</li> <li>ETUPRCS and ETUPR40.5CS recommended for DRT39ET-DRT48ET kits to secure drawer guide in ET system on cabinets with center stiles.</li> </ul>	
<b>ETUPRIGHTOV</b> 		
<b>ETUPRIGHT40.5</b> 		
<b>ETUPRCS</b> <b>ETUPR40.5CS</b>		

**GUIDE KITS AND PARTS**

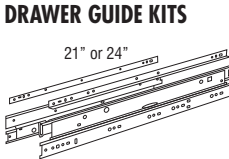
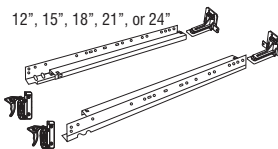
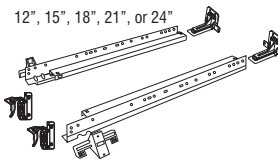
DESCRIPTION	MODEL	PRICE
<b>DRAWER GUIDE KITS</b>  21" or 24"	<b>DGK21DDFX</b>	281
	<b>DGK24DDFX</b>	281
<b>DGK__DDFX</b>  12", 15", 18", 21", or 24"	<b>DGKIT12PG</b>	246
	<b>DGKIT15PG</b>	246
	<b>DGKIT18PG</b>	246
	<b>DGKIT21PG</b>	246
	<b>DGKIT24PG</b>	246
<b>DGKIT__PG</b>  12", 15", 18", 21", or 24"	<b>DGKIT12RTSP</b>	246
	<b>DGKIT15RTSP</b>	246
	<b>DGKIT18RTSP</b>	246
	<b>DGKIT21RTSP</b>	246
	<b>DGKIT24RTSP</b>	246
<b>DGKIT__RTSP</b>	<ul style="list-style-type: none"> <li>Undermount full extension Smart Stop Premium Guide (PG).</li> <li>Maximum Weight Capacity: 90 lbs. per pair.</li> <li>Kit includes guide hardware for one drawer box (cabinets and drawer members, sockets and screws) Dimension refers to cabinet depth.</li> </ul>	

DESCRIPTION	MODEL	PRICE
<b>DRAWER GUIDE BACK SOCKETS</b>  12" or 24"	<b>BKSOCKET-PG</b>	46
	<b>BKSOCKET-SP</b>	46
	<ul style="list-style-type: none"> <li>BKSOCKET-PG used with Smart Stop drawer guides (12"-24" deep).</li> <li>BKSOCKET-SP used with Smart Stop roll tray guides.</li> <li>Sold in pairs.</li> </ul>	

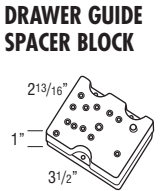
DESCRIPTION	MODEL	PRICE
<b>DRAWER GUIDE SPACER BLOCK</b>  1" x 3 1/2" x 2 13/16"	<b>SPACERBLK</b>	28
	<ul style="list-style-type: none"> <li>Sold in pairs.</li> <li>For use with DGKIT.PG and DGKIT.SP kits when RD is used for depths other than in 3" increments.</li> <li>One SPACERBLK required for each inch of depth.</li> <li>Not required for use with 23", 20", 17", 14" depth.</li> </ul>	

DESCRIPTION	MODEL	PRICE
<b>FALSE PANEL CLIPS</b> 	<b>FALSEPNLCLIP50</b>	8
	<b>PFALSEPNLCLIP50</b>	8
	<ul style="list-style-type: none"> <li>Use to secure false front on sink base.</li> <li>Sold in pairs.</li> </ul>	

DESCRIPTION	MODEL	PRICE
<b>ROLL TRAY PLUG IN BRACKET</b> 	<b>RTBKSXSP</b>	47
	<ul style="list-style-type: none"> <li>For use with roll tray hardware to prevent interference with door hinges. Also included in roll tray hardware kit.</li> <li>Includes four end panel brackets, two vertical stile brackets, and screws.</li> </ul>	

DESCRIPTION	MODEL	PRICE
<b>STAIN, PAINT, &amp; TOUCH-UP TOOLS</b>		

**STAIN & PAINT**



<b>QUARTCOLOR</b>	170
<b>SSC</b>	62
<b>SSCCLEAR</b>	62
<b>SSCMATTESH</b>	62

- Wiping stains can be sprayed at low pressure.
- Specify finish name and wood type when ordering.
- QUARTCOLOR sold in quarts.
- SSC is a 384 mL aerosol can available in Paint colors.
- SSCCLEAR is a 384 mL aerosol can in clear.
- SSCMATTESH is a 384 mL aerosol can in clear with a matte sheen.
- QUARTCOLOR and SSC will match the cabinet box color when ordered in Arctic, Antler, Elk, Gunstock, High Gloss White, High Gloss White with Metallic, Icy Avalanche Linea Nightfall, Obsidian, Squall, and Wharf.
- For Touch-up Kits and Glaze Pens, see below.

**TOUCH-UP TOOLS**

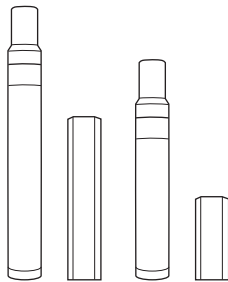

**TUK**

**MTUK**

<b>TUK</b>	88
<b>MTUK</b>	45
<b>GLAZEPEN</b>	51

- Touch-up Kit includes touch-up marker and a fill stick.
- MTUK ordered in Paints with glaze will only contain the base color.
- Mini Touch-up Kit includes small touch-up marker and a small fill stick.
- GLAZEPEN available in glaze colors only.
- GLAZEPEN works on finished doors and does not require a separate top coat.



**CABINET CARE KIT (PURE&SIMPLE™)**





<b>CABCLEANKIT</b>	50
--------------------	----



- PURE&SIMPLE™ Cabinet Care Kit includes one 16 ounce spray bottle of cleaning solution and a small microfiber cloth.
- Safe for use on wood and laminate cabinet surfaces.

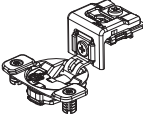
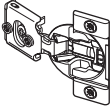
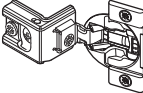
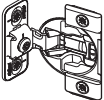
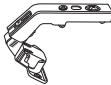









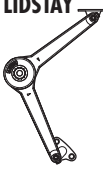

DESCRIPTION	MODEL	PRICE
<b>HINGES</b>		
 <p><b>HINGEQRPO</b> <b>Quick-Release™ with Integrated Smart Stop, 6-way Adjustable, Partial Overlay, 107° Hinge</b> 30</p> <p>All cabinets not specified by other hinges. For use on full overlay styles: Diagonal Wall (DW) and Base (DAB) Cabinets, Angled Corner Sink Bases (ACS) &amp; Fronts (ACSF), Wall Top Hinge (WTH) Cabinets with Modified Full Overlay (MFO).</p>		
 <p><b>HINGEQRFO</b> <b>Quick-Release™ with Integrated Smart Stop, 6-way Adjustable, Full Overlay, 107° Hinge</b> 30</p> <p>All cabinets not specified by other hinges.</p>		
 <p><b>38NPOHINGE</b> <b>Integrated Smart Stop, 6-way Adjustable, 1/2" Partial Overlay, 107° Hinge</b> 30</p> <p>For use on Base Message Center (BMC) and on full overlay styles: Base Transition Cabinets (BTC), Wall Transition Cabinets (WTC), and Stacked Wall Transition Cabinets (STWTC).</p>		
 <p><b>38CFOHINGE</b> <b>Integrated Smart Stop, 6-way Adjustable, Full Overlay, 107° Hinge</b> 30</p> <p>For use on Base Message Center (BMC)</p>		
 <p><b>38BFOVHINGE</b> <b>Integrated Soft-close, 4-way Adjustable, Full Overlay, Face-mount 107° Hinge</b> 30</p> <p>OCD, OMC, OCS, and TBMW cabinets 36" and 42" high WBMW, full and partial overlay</p>		
 <p><b>32049HINGE</b> <b>90° Corner Self-Closing Center Hinge</b> 79</p> <p>Center Hinge for ER, BLS, SLS, BER, BERAS, and CS</p>		
 <p><b>942HINGE</b> <b>170° Hinge</b> 67</p> <p>BSC, BLS, SLS, BER, BERAS, CS, and ER</p>		
 <p><b>7299HINGE</b> <b>Mirror Hinge</b> 13</p> <p>TV and MC cabinets</p>		

• Sold in pairs.

 <p><b>HINGE ANGLE RESTRICTION CLIPS</b></p>	 <p><b>RESCLIPQR</b> 13</p>
 <p><b>HINGERESCLIP</b></p>	<p><b>HINGERESCLIP</b> 13</p> <ul style="list-style-type: none"> <li>• For use in applications with cabinets installed at varying depths to prevent the door damage caused by opening into an adjacent cabinet.</li> <li>• Restricts hinges to 86° opening capability.</li> <li>• RESCLIPQR works only with the HINGEQRPO and HINGEQRFO.</li> <li>• HINGERESCLIP works only with the 38NPOHINGE and 38CFOHINGE.</li> <li>• Not recommended for cabinets with roll trays specified in partial overlay styles.</li> <li>• Sold in pairs.</li> </ul>

DESCRIPTION	MODEL	PRICE
 <p><b>HINGESHIMS</b> 17</p> <ul style="list-style-type: none"> <li>• Install between the face frame and hinge to allow additional adjustment of doors. Can be used to reduce gap between butt doors.</li> <li>• Pack of 5 metal shims.</li> <li>• Compatible with all hinges except face-mount.</li> </ul>		
 <p><b>LIDSTAY</b> 221</p> <ul style="list-style-type: none"> <li>• Sold in pairs.</li> <li>• Recommended for field installed wall top hinge applications 12" to 18" high.</li> </ul>		
 <p><b>LIDSTAY - HEAVY DUTY</b> 203</p> <ul style="list-style-type: none"> <li>• One heavy duty lid stay hinge required per cabinet.</li> <li>• Recommended for field installed wall top hinge applications of 21" high cabinets.</li> </ul>		
 <p><b>WTHRESCLIP75</b> 13</p> <ul style="list-style-type: none"> <li>• For use on 9" high Wall Top Hinge cabinets only.</li> <li>• Restricts opening angle of the door to 75°.</li> <li>• Prevents the door from hitting the ceiling or an object above, also keeps the handle within reach on very high cabinets.</li> <li>• Sold in pairs (two clips required per cabinet).</li> </ul>		

DESCRIPTION	MODEL	PRICE
-------------	-------	-------

DOORS, DRAWER FRONTS, & DRAWERS		
<b>DOORS &amp; DRAWER FRONTS</b>	 Standard Door Size, 18" High or Less	285 ea.
	Standard Door Size, 21" to 30" High	353 ea.
	Standard Door Size, 33" or Higher	499 ea.
	Standard Door Size, No Hinge Route, 18" High or Less	285 ea.
	Standard Door Size, No Hinge Route, 21" to 30" High	353 ea.
	Standard Door Size, No Hinge Route, 33" or Higher	499 ea.
	Any Drawer Front	126 ea.

- Door heights are based on full overlay for equivalent applications.
- All applicable modification and premium finish upcharges will apply.
- Backs of "NO HINGE ROUTE" doors may have identification marks, be unfinished, and have 3/16" diameter holes used during finish processing. For these reasons, these doors are not suitable for use as cabinet doors.

**DRAWERS**



<b>Complete Drawer</b>	204 ea.
<b>Drawer Box Only</b>	181 ea.

- All applicable modification and premium finish upcharges will apply.
- Complete Drawer and Drawer Box Only do not include drawer guides. They must be ordered separately.

**Species Availability (Wood)**

Alder	Rustic Alder	Cherry	Rustic Hickory	Maple	Oak
•	•	•	•	•	•

**Species Availability (All Laminates)**

High Glass	Horiz. Grain on Maple	Vert. Grain on Maple	Vert. Grain on Cherry	Vert. Grain on Oak
•	•	•	•	•

DESCRIPTION	MODEL	PRICE
-------------	-------	-------

PARTS		
<b>MISCELLANEOUS PARTS</b>	 <b>BRKOFFSCREW</b> (pkg. 25)	5
	<b>INSTALLSCR24</b> (pkg. 24)	13
	<b>INSTALLSCREWS</b> (pkg. 100)	42
	<b>TVHDW/WCATCH</b>	129
	<b>MC16HDW/WCATCH</b>	67
	<b>RETCLIP250BAG</b>	18
	<b>BUMPERPADS</b> (pkg. 25)	7
	<b>PDM</b>	35
	<b>SHELFPEGS</b> (pkg. 24)	11
	<b>SHELFPEGSCTR</b> (pkg. 6)	5

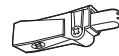

**PDM**

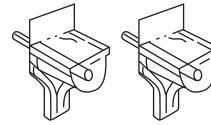

**SHELFPEGS**

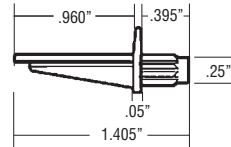

**SHELFPEGSCTR**

- BRKOFFSCREW is a pack of 25 breakaway screws for use with decorative hardware pulls and knobs.
- INSTALLSCR24 and INSTALLSCREWS are screws for cabinet installation through the cabinet back to the wall studs (includes a pack of 24 or 100).
- TVHDW/WCATCH is one set of the magnetic catch hardware and handle used on mirrors on Tri-View Mirrors (TV..).
- MC16HDW/WCATCH is one set of the magnetic catch hardware, handle, and one pair of hinges used on Single Door Medicine Cabinets (MC16).
- RETCLIP250BAG: 6 retainer clips for use with glass inserts in mullion and cut-for-glass doors.
- PDM creates a smooth and silent self-closing motion and includes all installation hardware.
- SHELFPEGS are 3mm steel pins with clear plastic shoulders.
- SHELFPEGSCTR is a package of 6 clear plastic shelf clips with 0.96" usable depth with 1/4" diameter pegs used on center mullions of full depth shelves.

**DESCRIPTION**

**MODEL**

**PRICE**

**STACK MOULDING KITS**

- Moulding stacks do not ship assembled; field assembly is required. Assembly instructions can be viewed in 20/20 spec pages and will also ship with moulding kits.
- When ordered as a kit, only one finish can be specified. To order with more than one finish, moulding pieces must be ordered separately.
- Moulding stacks include Assembly Instructions. Cleats and finish nails not included.

- How to place a stack moulding in 20/20:
  - Moulding
  - Top Mouldings or Bottom Mouldings
  - Stacked Mouldings
  - Drag and drop desired moulding stack onto wall cabinets
- Mouldings specified as 8' nominal length have a usable length range of 93" up to 99". Mouldings specified as 10' nominal length have a usable length range of 117" up to 123". Be sure to order the correct amount of moulding length to work around required cuts with minimal butt joints.

592

**MOULDING STACK 1**

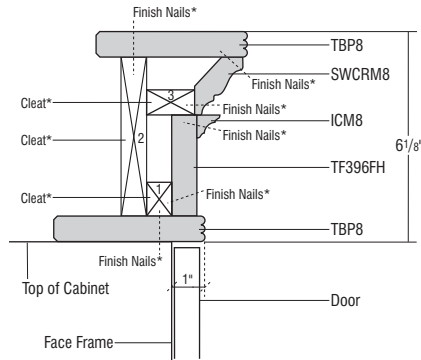
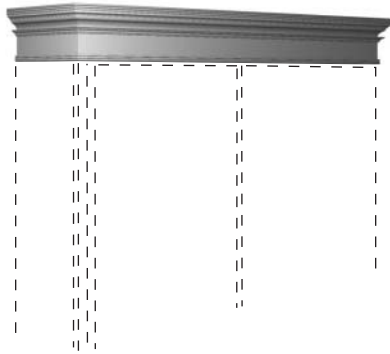

\*Cleats and finish nails not included.



**STKMLD1**

1041

**Finish Techniques**

	Distressing	Heirlooming
TBP8		•
SWCRM8	•	•
ICM8		
TF396FH	•	

**Species Availability (Wood)**

	Alder	Rustic Alder	Cherry	Rustic Hickory	Maple	Oak
TBP8	•					•
SWCRM8	•	•	•	•	•	•
ICM8	•	Alder	•	Hickory	•	•
TF396FH	•	Alder	•	Hickory	•	•

**Species Availability (All Laminates)**

	High Gloss	Horiz. Grain on Maple	Vert. Grain on Maple	Vert. Grain on Cherry	Vert. Grain on Oak
TBP8	box color	box color	box color	box color	box color
SWCRM8	box color	box color	box color	box color	box color
ICM8	box color	box color	box color	box color	box color
TF396FH	box color	box color	box color	box color	box color

**MOULDING STACK 2**

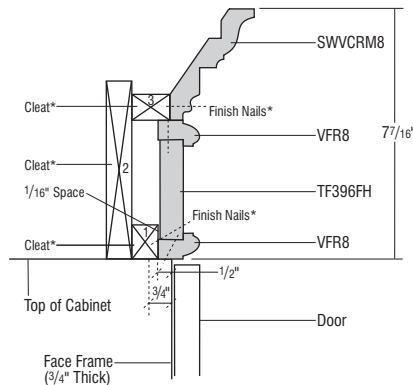
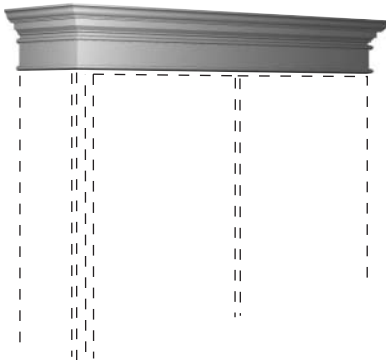

\*Cleats and finish nails not included.



**STKMLD2**

741

**Finish Techniques**

	Distressing	Heirlooming
SWVCRM8	•	•
VFR8		•
TF396FH	•	

**Species Availability (Wood)**

	Alder	Rustic Alder	Cherry	Rustic Hickory	Maple	Oak
SWVCRM8	•	•	•	•	•	•
VFR8	•	Alder	•	Hickory	•	•
TF396FH	•	Alder	•	Hickory	•	•

**Species Availability (All Laminates)**

	High Gloss	Horiz. Grain on Maple	Vert. Grain on Maple	Vert. Grain on Cherry	Vert. Grain on Oak
SWVCRM8	box color	box color	box color	box color	box color
VFR8	box color	box color	box color	box color	box color
TF396FH	box color	box color	box color	box color	box color

**DESCRIPTION**

**MODEL**

**PRICE**

**MOULDING STACK 3**

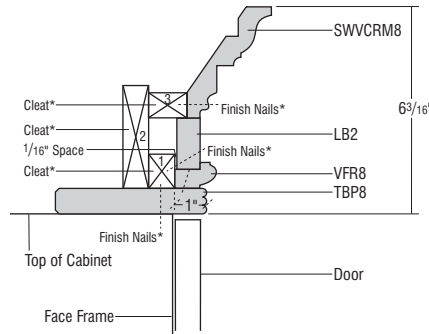
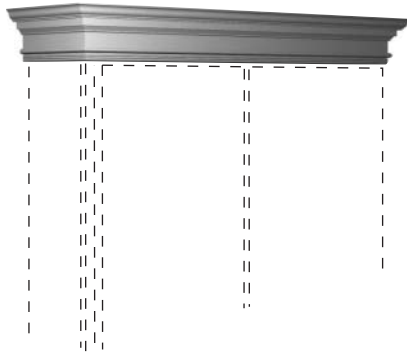

\*Cleats and finish nails not included.



**STKMLD3**

**823**

- Not recommended for use when taking application to the ceiling.

**Finish Techniques**

	Distressing	Heirlooming
SWVCRM8	•	•
LB2		
VFR8		•
TBP8		•

**Species Availability (Wood)**

	Alder	Rustic Alder	Cherry	Rustic Hickory	Maple	Oak
SWVCRM8	•	•	•	•	•	•
LB2	•	Alder	•	Hickory	•	•
VFR8	•	Alder	•	Hickory	•	•
TBP8	•	Alder	•	Hickory	•	•

**Species Availability (All Laminates)**

	High Gloss	Horiz. Grain on Maple	Vert. Grain on Maple	Vert. Grain on Cherry	Vert. Grain on Oak
SWVCRM8	box color	box color	box color	box color	box color
LB2	box color	box color	box color	box color	box color
VFR8	box color	box color	box color	box color	box color
TBP8	box color	box color	box color	box color	box color

**593**

**MOULDING STACK 5**

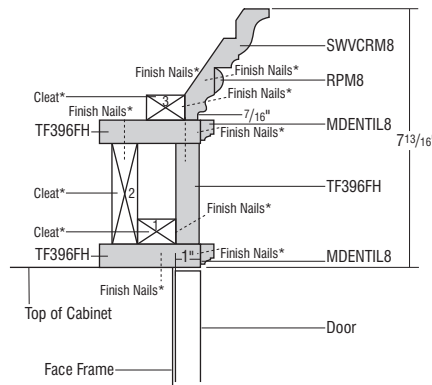
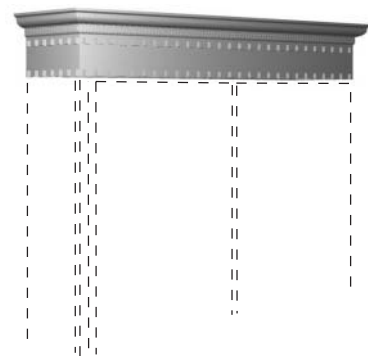

\*Cleats and finish nails not included.



**STKMLD5**

**1236**

**Finish Techniques**

	Distressing	Heirlooming
SWVCRM8	•	•
RPM8		
MDENTIL8		
TF396FH	•	

**Species Availability (Wood)**

	Alder	Rustic Alder	Cherry	Rustic Hickory	Maple	Oak
SWVCRM8	•	•	•		•	•
RPM8	•	Alder	•		•	•
MDENTIL8	•	Alder	•		•	•
TF396FH	•	Alder	•		•	•

**Species Availability (All Laminates)**

	High Gloss	Horiz. Grain on Maple	Vert. Grain on Maple	Vert. Grain on Cherry	Vert. Grain on Oak
SWVCRM8	box color	box color	box color	box color	box color
RPM8	box color	box color	box color	box color	box color
MDENTIL8	box color	box color	box color	box color	box color
TF396FH	box color	box color	box color	box color	box color

**MOULDING STACK 6**

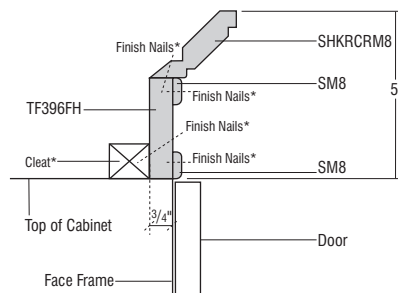
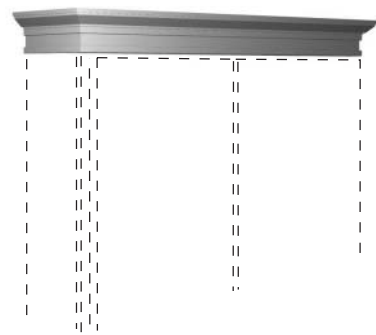

\*Cleats and finish nails not included.



**STKMLD6**

**548**

- Not recommended for use when taking application to the ceiling.

**Finish Techniques**

	Distressing	Heirlooming
SHKRCRM8	•	•
SM8		
TF396FH	•	

**Species Availability (Wood)**

	Alder	Rustic Alder	Cherry	Rustic Hickory	Maple	Oak
SHKRCRM8	•	•	•	•	•	•
SM8	•	Alder	•	Hickory	•	•
TF396FH	•	Alder	•	Hickory	•	•

**Species Availability (All Laminates)**

	High Gloss	Horiz. Grain on Maple	Vert. Grain on Maple	Vert. Grain on Cherry	Vert. Grain on Oak
SHKRCRM8	box color	box color	box color	box color	box color
SM8	box color	box color	box color	box color	box color
TF396FH	box color	box color	box color	box color	box color

**MOULDING STACK 7**

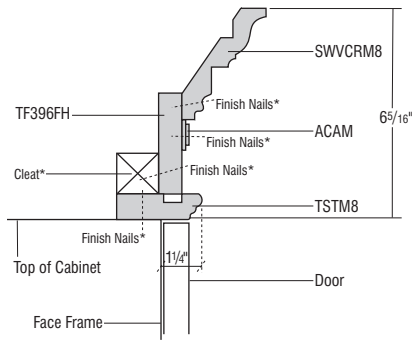
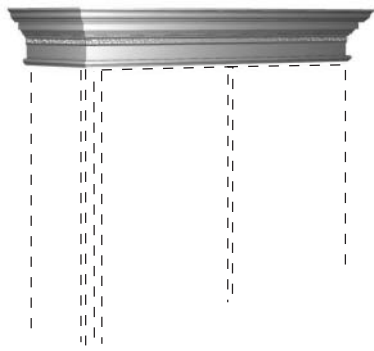

\*Cleats and finish nails not included.



**STKMLD7**

1079

- Not recommended for use when taking application to the ceiling.

**Finish Techniques**

	Distressing	Heirlooming
SWVCRM8	•	•
ACAM		
TF396FH	•	
TSTM8		

**Species Availability (Wood)**

	Alder	Rustic Alder	Cherry	Rustic Hickory	Maple	Oak
SWVCRM8	•	•	•	•	•	•
ACAM	•	Alder	•	Beech	•	Beech
TF396FH	•	Alder	•	Hickory	•	•
TSTM8	•	Alder	•	Hickory	•	•

**Species Availability (All Laminates)**

	High Glass	Horiz. Grain on Maple	Vert. Grain on Maple	Vert. Grain on Cherry	Vert. Grain on Oak
SWVCRM8	box color	box color	box color	box color	box color
ACAM	box color	box color	box color	box color	Beech
TF396FH	box color	box color	box color	box color	box color
TSTM8	box color	box color	box color	box color	box color

**MOULDING STACK 8**

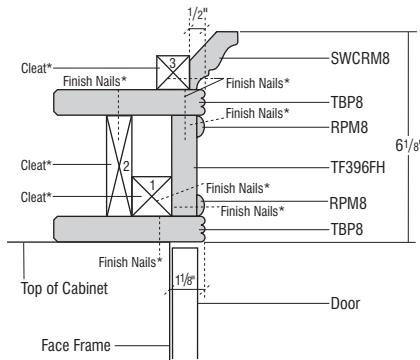
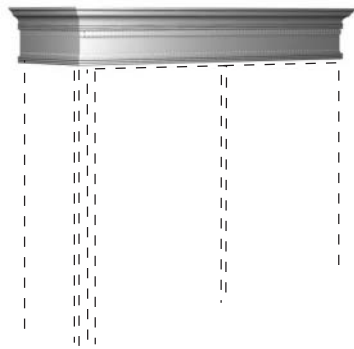

\*Cleats and finish nails not included.



**STKMLD8**

1184

- Not recommended for use when taking application to the ceiling.

**Finish Techniques**

	Distressing	Heirlooming
SWCRM8	•	•
RPM8		
TBP8		•
TF396FH	•	

**Species Availability (Wood)**

	Alder	Rustic Alder	Cherry	Rustic Hickory	Maple	Oak
SWCRM8	•	•	•	•	•	•
RPM8	•	Alder	•	Hickory	•	•
TBP8	•	Alder	•	Hickory	•	•
TF396FH	•	Alder	•	Hickory	•	•

**Species Availability (All Laminates)**

	High Glass	Horiz. Grain on Maple	Vert. Grain on Maple	Vert. Grain on Cherry	Vert. Grain on Oak
SWCRM8	box color	box color	box color	box color	box color
RPM8	box color	box color	box color	box color	box color
TBP8	box color	box color	box color	box color	box color
TF396FH	box color	box color	box color	box color	box color

**MOULDING STACK 10**

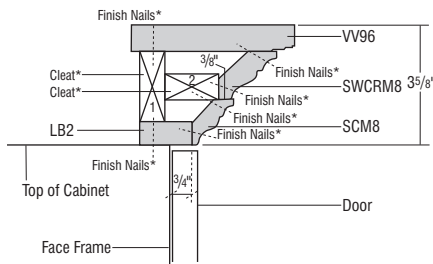
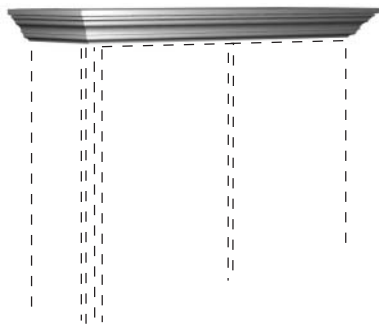

\*Cleats and finish nails not included.



**STKMLD10**

643

- Not recommended for use when taking application to the ceiling.

**Finish Techniques**

	Distressing	Heirlooming
VV96	•	•
SWCRM8	•	•
SCMB	•	•
LB2		

**Species Availability (Wood)**

	Alder	Rustic Alder	Cherry	Rustic Hickory	Maple	Oak
VV96	•	•	•	•	•	•
SWCRM8	•	•	•	•	•	•
SCMB	•	•	•	•	•	•
LB2	•	Alder	•	Hickory	•	•

**Species Availability (All Laminates)**

	High Glass	Horiz. Grain on Maple	Vert. Grain on Maple	Vert. Grain on Cherry	Vert. Grain on Oak
VV96	box color	box color	box color	box color	box color
SWCRM8	box color	box color	box color	box color	box color
SCMB	box color	box color	box color	box color	box color
LB2	box color	box color	box color	box color	box color

**DESCRIPTION**

**MODEL**

**PRICE**

**MOULDING STACK 11**

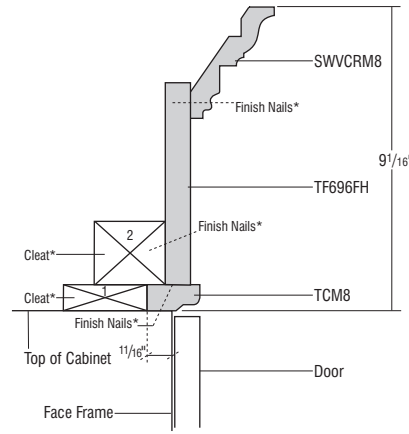
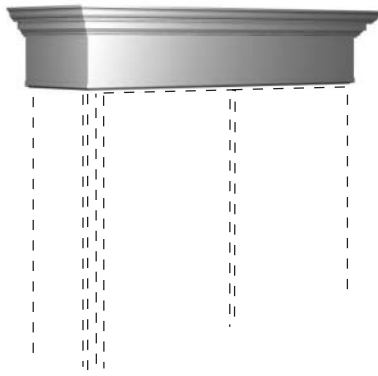

\*Cleats and finish nails not included.



**STKMLD11**

**768**

**Finish Techniques**

	Distressing	Heirlooming
SWVCRM8	•	•
TF696FH	•	
TCM8		•

**Species Availability (Wood)**

	Alder	Rustic Alder	Cherry	Rustic Hickory	Maple	Oak
SWVCRM8	•	•	•	•	•	•
TF696FH	•	Alder	•	Hickory	•	•
TCM8	•	Alder	•	Hickory	•	•

**Species Availability (All Laminates)**

	High Gloss	Horiz. Grain on Maple	Vert. Grain on Maple	Vert. Grain on Cherry	Vert. Grain on Oak
SWVCRM8	box color	box color	box color	box color	box color
TF696FH	box color	box color	box color	box color	box color
TCM8	box color	box color	box color	box color	box color

**595**

**MOULDING STACK 13**

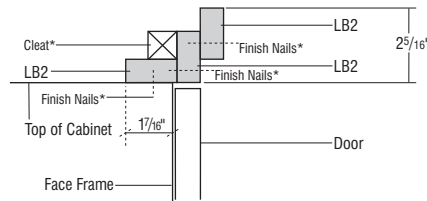
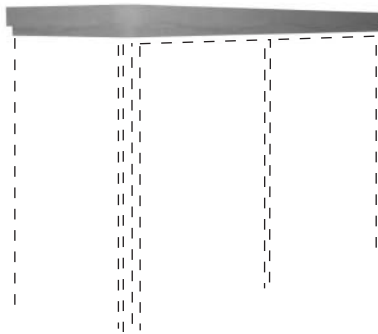

\*Cleats and finish nails not included.



**STKMLD13**

**351**

**Finish Techniques**

	Distressing	Heirlooming
LB2		

**Species Availability (Wood)**

	Alder	Rustic Alder	Cherry	Rustic Hickory	Maple	Oak
LB2	•	Alder	•	Hickory	•	•

**Species Availability (All Laminates)**

	High Gloss	Horiz. Grain on Maple	Vert. Grain on Maple	Vert. Grain on Cherry	Vert. Grain on Oak
LB2	box color	box color	box color	box color	box color

**MOULDING STACK 14**

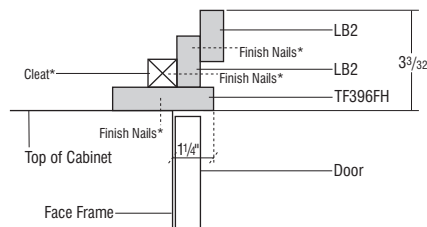
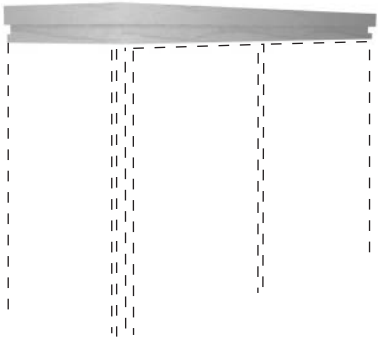

\*Cleats and finish nails not included.



**STKMLD14**

**454**

**Finish Techniques**

	Distressing	Heirlooming
LB2		
TF396FH	•	

**Species Availability (Wood)**

	Alder	Rustic Alder	Cherry	Rustic Hickory	Maple	Oak
LB2	•	Alder	•	Hickory	•	•
TF396FH	•	Alder	•	Hickory	•	•

**Species Availability (All Laminates)**

	High Gloss	Horiz. Grain on Maple	Vert. Grain on Maple	Vert. Grain on Cherry	Vert. Grain on Oak
LB2	box color	box color	box color	box color	box color
TF396FH	box color	box color	box color	box color	box color

DESCRIPTION

MODEL

PRICE

MOULDING STACK 16

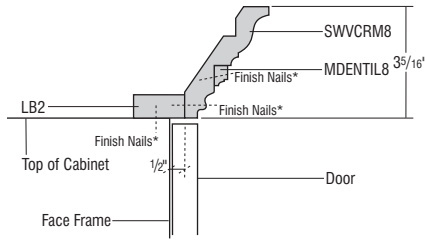
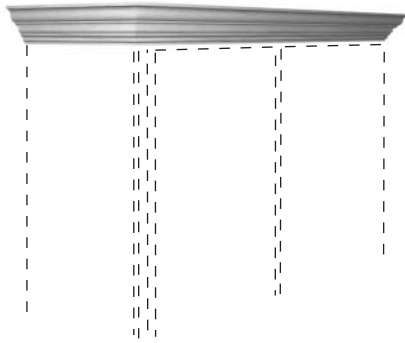

\*Cleats and finish nails not included.



STKMLD16

498

- Not recommended for use when taking application to the ceiling.

Finish Techniques

	Distressing	Heirlooming
SWVCRM8	•	•
MDENTIL8		
LB2		

Species Availability (Wood)

	Alder	Rustic Alder	Cherry	Rustic Hickory	Maple	Oak
SWVCRM8	•	•	•		•	•
MDENTIL8	•	Alder	•		•	•
LB2	•	Alder	•		•	•

Species Availability (All Laminates)

	High Glass	Horiz. Grain on Maple	Vert. Grain on Maple	Vert. Grain on Cherry	Vert. Grain on Oak
SWVCRM8	box color	box color	box color	box color	box color
MDENTIL8	box color	box color	box color	box color	box color
LB2	box color	box color	box color	box color	box color

MOULDING STACK 17

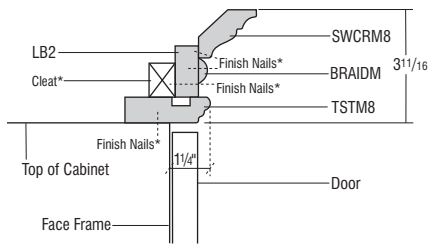
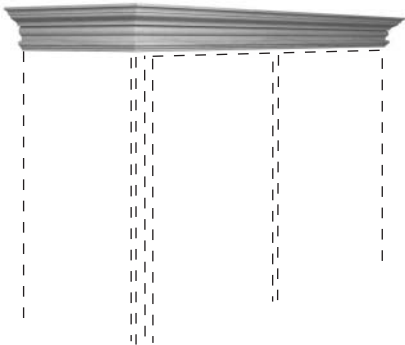

\*Cleats and finish nails not included.



STKMLD17

677

- Not recommended for use when taking application to the ceiling.

Finish Techniques

	Distressing	Heirlooming
SWCRM8	•	•
LB2		
BRAIDM		
TSTM8		

Species Availability (Wood)

	Alder	Rustic Alder	Cherry	Rustic Hickory	Maple	Oak
SWCRM8	•	•	•	•	•	•
LB2	•	Alder	•	Hickory	•	•
BRAIDM	•	Alder	•	Beech	•	Beech
TSTM8	•	Alder	•	Hickory	•	•

Species Availability (All Laminates)

	High Glass	Horiz. Grain on Maple	Vert. Grain on Maple	Vert. Grain on Cherry	Vert. Grain on Oak
SWCRM8	box color	box color	box color	box color	box color
LB2	box color	box color	box color	box color	box color
BRAIDM	box color	box color	box color	box color	Beech
TSTM8	box color	box color	box color	box color	box color

MOULDING STACK 18

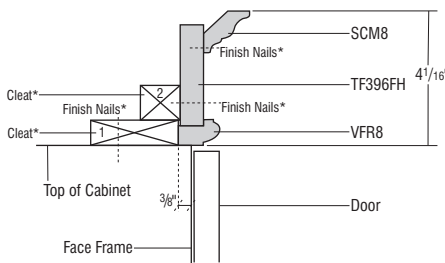
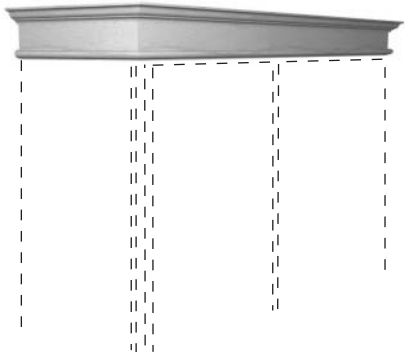

\*Cleats and finish nails not included.



STKMLD18

470

Finish Techniques

	Distressing	Heirlooming
SCM8	•	•
TF396FH	•	
VFR8		•

Species Availability (Wood)

	Alder	Rustic Alder	Cherry	Rustic Hickory	Maple	Oak
SCM8	•	•	•	•	•	•
TF396FH	•	Alder	•	Hickory	•	•
VFR8	•	Alder	•	Hickory	•	•

Species Availability (All Laminates)

	High Glass	Horiz. Grain on Maple	Vert. Grain on Maple	Vert. Grain on Cherry	Vert. Grain on Oak
SCM8	box color	box color	box color	box color	box color
TF396FH	box color	box color	box color	box color	box color
VFR8	box color	box color	box color	box color	box color

**DESCRIPTION**

**MODEL**

**PRICE**

**MOULDING STACK 19**

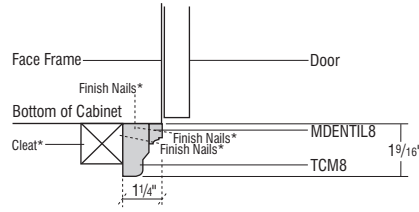
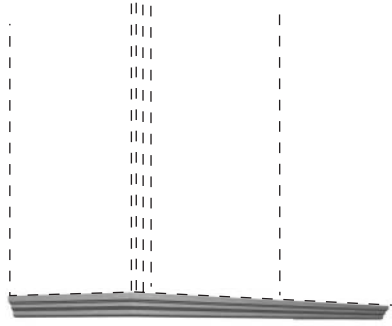

\*Cleats and finish nails not included.



**STKMULD19**

**178**

**Finish Techniques**

	Distressing	Heirlooming
MDENTIL8		
TCM8		•

**Species Availability (Wood)**

	Alder	Rustic Alder	Cherry	Rustic Hickory	Maple	Oak
MDENTIL8	•	Alder	•		•	•
TCM8	•	Alder	•		•	•

**Species Availability (All Laminates)**

	High Gloss	Horiz. Grain on Maple	Vert. Grain on Maple	Vert. Grain on Cherry	Vert. Grain on Oak
MDENTIL8	box color	box color	box color	box color	box color
TCM8	box color	box color	box color	box color	box color

**597**

**MOULDING STACK 20**

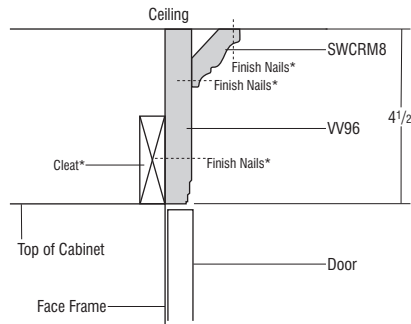
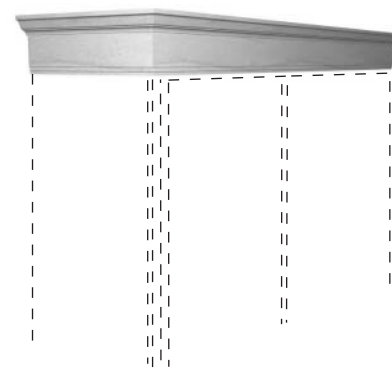

\*Cleats and finish nails not included.



**STKMULD20**

**388**

**Finish Techniques**

	Distressing	Heirlooming
SWCRM8	•	•
VV96	•	•

**Species Availability (Wood)**

	Alder	Rustic Alder	Cherry	Rustic Hickory	Maple	Oak
SWCRM8	•	•	•	•	•	•
VV96	•	•	•	•	•	•

**Species Availability (All Laminates)**

	High Gloss	Horiz. Grain on Maple	Vert. Grain on Maple	Vert. Grain on Cherry	Vert. Grain on Oak
SWCRM8	box color	box color	box color	box color	box color
VV96	box color	box color	box color	box color	box color

**MOULDING STACK 21**

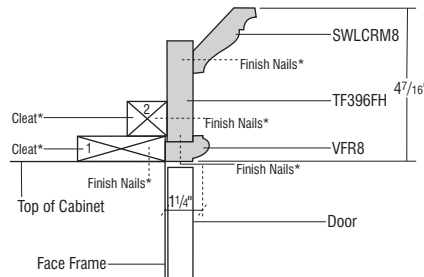
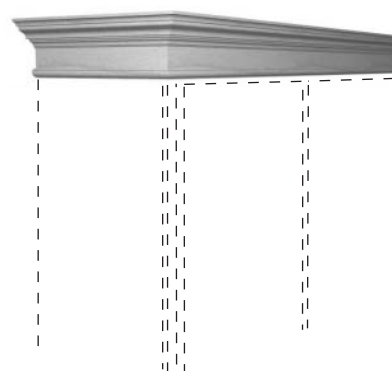

\*Cleats and finish nails not included.



**STKMULD21**

**582**

**Finish Techniques**

	Distressing	Heirlooming
SWLCRM8	•	•
TF396FH	•	
VFR8		•

**Species Availability (Wood)**

	Alder	Rustic Alder	Cherry	Rustic Hickory	Maple	Oak
SWLCRM8	•	•	•	•	•	•
TF396FH	•	Alder	•	Hickory	•	•
VFR8	•	Alder	•	Hickory	•	•

**Species Availability (All Laminates)**

	High Gloss	Horiz. Grain on Maple	Vert. Grain on Maple	Vert. Grain on Cherry	Vert. Grain on Oak
SWLCRM8	box color	box color	box color	box color	box color
TF396FH	box color	box color	box color	box color	box color
VFR8	box color	box color	box color	box color	box color



DESCRIPTION

MODEL

PRICE

MOULDING STACK 22

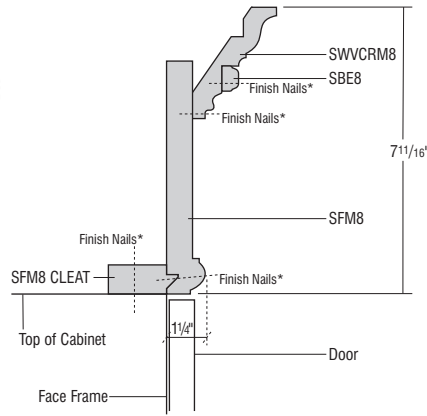
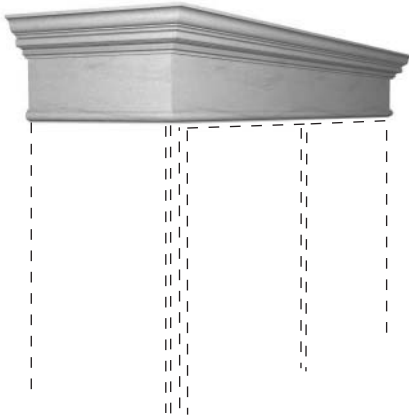

\*Cleats and finish nails not included.



STKMLD22

861

Finish Techniques

	Distressing	Heirlooming
SWVCRM8	•	•
SBE8		•
SFMB		•

Species Availability (Wood)

	Alder	Rustic Alder	Cherry	Rustic Hickory	Maple	Oak
SWVCRM8	•	•	•	•	•	•
SBE8	•	Alder	•	Hickory	•	•
SFMB	•	•	•	•	•	•

Species Availability (All Laminates)

	High Gloss	Horiz. Grain on Maple	Vert. Grain on Maple	Vert. Grain on Cherry	Vert. Grain on Oak
SWVCRM8	box color	box color	box color	box color	box color
SBE8	box color	box color	box color	box color	box color
SFMB	box color	box color	box color	box color	box color

MOULDING STACK 23

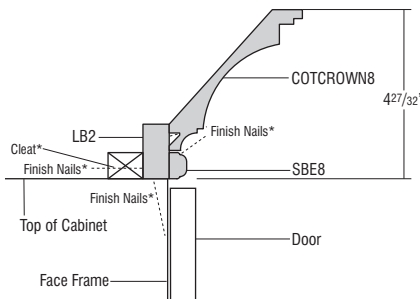
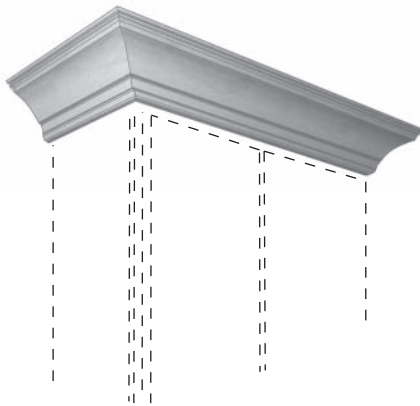

\*Cleats and finish nails not included.



STKMLD23

615

- Not recommended for use when taking application to the ceiling.

Finish Techniques

	Distressing	Heirlooming
COTCROWN8	•	•
LB2		
SBE8		•

Species Availability (Wood)

	Alder	Rustic Alder	Cherry	Rustic Hickory	Maple	Oak
COTCROWN8	•	•	•	•	•	•
LB2	•	Alder	•	Hickory	•	•
SBE8	•	Alder	•	Hickory	•	•

Species Availability (All Laminates)

	High Gloss	Horiz. Grain on Maple	Vert. Grain on Maple	Vert. Grain on Cherry	Vert. Grain on Oak
COTCROWN8	box color	box color	box color	box color	box color
LB2	box color	box color	box color	box color	box color
SBE8	box color	box color	box color	box color	box color

MOULDING STACK 24

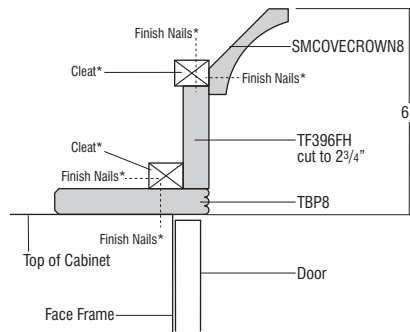
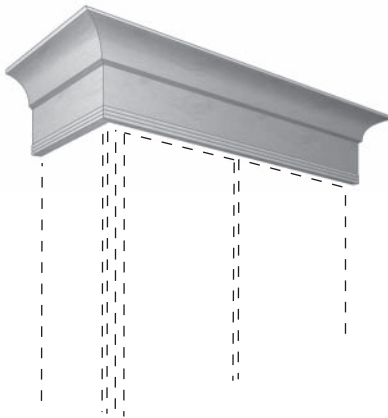

\*Cleats and finish nails not included.



STKMLD24

862

Finish Techniques

	Distressing	Heirlooming
SMCOVECROWN8	•	•
TF396FH	•	
TBP8		•

Species Availability (Wood)

	Alder	Rustic Alder	Cherry	Rustic Hickory	Maple	Oak
SMCOVECROWN8	•	•	•		•	•
TF396FH	•	Alder			•	•
TBP8	•	Alder	•		•	•

Species Availability (All Laminates)

	High Gloss	Horiz. Grain on Maple	Vert. Grain on Maple	Vert. Grain on Cherry	Vert. Grain on Oak
SMCOVECROWN8	box color	box color	box color	box color	box color
TF396FH	box color	box color	box color	box color	box color
TBP8	box color	box color	box color	box color	box color

**DESCRIPTION**

**MODEL**

**PRICE**

**MOULDING STACK 25**

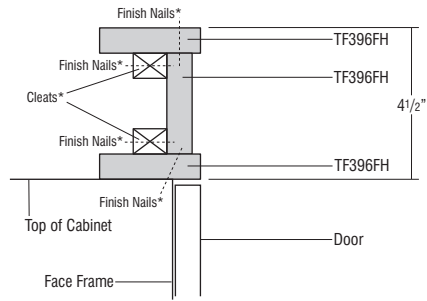
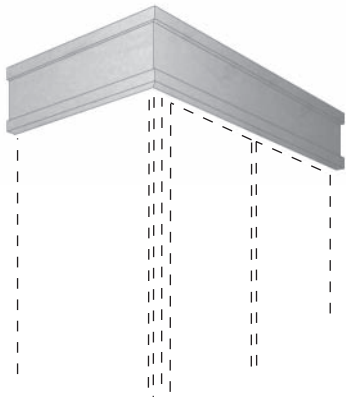

\*Cleats and finish nails not included.



**STKMLD25**

**660**

**Finish Techniques**

	Distressing	Heirlooming
TF396FH	•	

**Species Availability (Wood)**

	Alder	Rustic Alder	Cherry	Rustic Hickory	Maple	Oak
TF396FH	•	Alder	•	Hickory	•	•

**Species Availability (All Laminates)**

	High Gloss	Horiz. Grain on Maple	Vert. Grain on Maple	Vert. Grain on Cherry	Vert. Grain on Oak
TF396FH	box color	box color	box color	box color	box color

**599**

**MOULDING STACK 26**

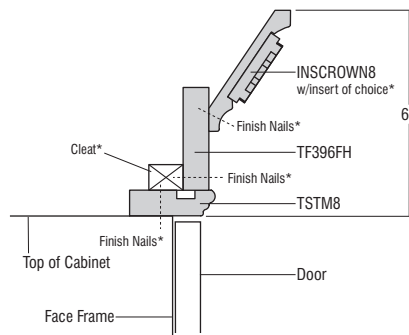

\*Price of Insert not included. Insert must be purchased separately. Cleats and finish nails not included.



**STKMLD26**

**855**

**Finish Techniques**

	Distressing	Heirlooming
INSCROWN8		•
TF396FH	•	
TSTM8		

**Species Availability (Wood)**

	Alder	Rustic Alder	Cherry	Rustic Hickory	Maple	Oak
INSCROWN8	•	Alder	•		•	•
TF396FH	•	Alder	•		•	•
TSTM8	•	Alder	•		•	•

**Species Availability (All Laminates)**

	High Gloss	Horiz. Grain on Maple	Vert. Grain on Maple	Vert. Grain on Cherry	Vert. Grain on Oak
INSCROWN8	box color	box color	box color	box color	box color
TF396FH	box color	box color	box color	box color	box color
TSTM8	box color	box color	box color	box color	box color

**MOULDING STACK 27**

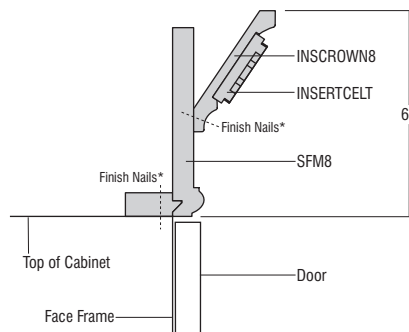
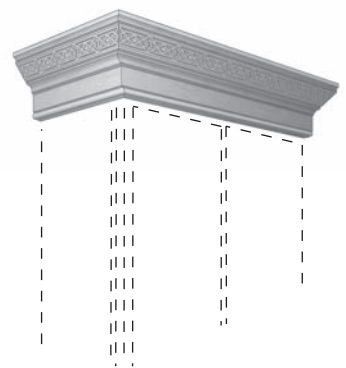

\*Cleats and finish nails not included.



**STKMLD27**

**1727**

**Finish Techniques**

	Distressing	Heirlooming
INSCROWN8		•
INSERTCELT		•
SFM8		•

**Species Availability (Wood)**

	Alder	Rustic Alder	Cherry	Rustic Hickory	Maple	Oak
INSCROWN8	•	Alder	•		•	•
INSERTCELT			•		•	
SFM8	•	•	•		•	•

**Species Availability (All Laminates)**

	High Gloss	Horiz. Grain on Maple	Vert. Grain on Maple	Vert. Grain on Cherry	Vert. Grain on Oak
INSCROWN8	box color	box color	box color	box color	box color
INSERTCELT	box color	box color	box color	box color	box color
SFM8	box color	box color	box color	box color	box color

**DESCRIPTION**

**MODEL**

**PRICE**

**MOULDING STACK 28**

**STKMLD28**

**563**



- Not recommended for use when taking application to the ceiling.

**Finish Techniques**

	Distressing	Heirlooming
FOLCROWN8		•
BBM8	•	•

**Species Availability (Wood)**

	Alder	Rustic Alder	Cherry	Rustic Hickory	Maple	Oak
FOLCROWN8	•	•	•	•	•	•
BBM8	•	•	•	•	•	•

**Species Availability (All Laminates)**

	High Gloss	Horiz. Grain on Maple	Vert. Grain on Maple	Vert. Grain on Cherry	Vert. Grain on Oak
FOLCROWN8	box color	box color	box color	box color	box color
BBM8	box color	box color	box color	box color	box color

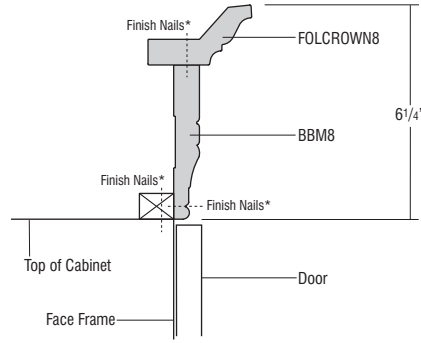
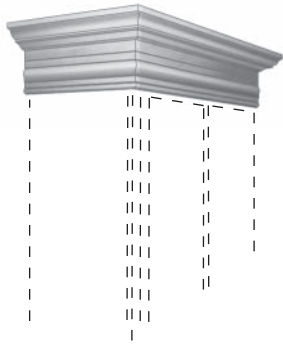

\*Cleats and finish nails not included.

**600**

# Schrock™

Dear Schrock Customer,

Congratulations on your selection of Schrock cabinetry with an Heirlooming finish. Because of its unique characteristics, this finish is quite different from other cabinetry finishes you may be familiar with. Your satisfaction is important to Schrock, and we want you to fully understand the characteristics that make an Heirlooming Finish unique.

The finish will be sanded through the base coat to expose the surface of the wood. This type of sand through on the edges and profiles creates a naturally worn appearance. If a finish is chosen with a glaze, the glaze will be applied after sanding has been done. This will enhance those areas of exposed wood to take on the darker characteristics of the applied glaze.

Normal Characteristics of Painted, Sand-Through Finishes include:

- Hairline Cracking
- Visible textures of natural grain patterns
- Variation in rub through and wear techniques

Accordingly, we ask that the following agreement be signed for Heirlooming Finish orders.

I have read the foregoing and find the characteristic variations of wood with Heirlooming finish are desirable. As such, I agree not to hold Schrock and/or the Schrock dealer listed below responsible in the event that these characteristics are later found by me to be less desirable than I had expected.

\_\_\_\_\_  
Customer Signature

\_\_\_\_\_  
Dealer Signature

\_\_\_\_\_  
Customer Name (please print)

\_\_\_\_\_  
Dealer Name (please print)

\_\_\_\_\_  
Dealer Purchase Order Number

# Schrock™

Dear Schrock Customer,

Congratulations on your selection of Schrock cabinetry in a Paint or Paint with Glaze finish. Because of its unique characteristics, this finish is quite different from other cabinetry finishes you may be familiar with. Your satisfaction is important to Schrock, and we want you to fully understand the characteristics that make painted finishes so distinctive.

It is important to realize that the beauty of wood cabinetry comes from the natural qualities of wood itself. Schrock utilizes only select solid hardwoods and veneers. The beauty of these genuine woods lies in the variation of the grain. The textures of those natural grain patterns often remain visible with paint finish and should be accepted as inherent characteristics when selecting painted cabinetry. When ordering painted Maple 5-piece styles (except Whittaker), the door's center panel will be constructed of MDF material.

On both Maple and MDF, seam lines and hairline cracking at stile, rail and panel joints are normal characteristics of painted finishes and should not be considered a reason for product replacement. Over time, there may be a slight color shift in the paint finish due to the continued exposure to natural and artificial light sources. We mention these characteristics because neither Schrock nor your Schrock dealer can be responsible for these conditions and variations.



*Example of front joint separation*



*Example of front joint separation*



*Example of end joint separation*

Accordingly, we ask that the following agreement be signed for Paint Finish orders.

I have read the foregoing and find the characteristic variations of wood and MDF with painted finish are desirable. As such, I agree not to hold Schrock and/or the Schrock dealer listed below responsible in the event that these characteristics are later found by me to be less desirable than I had expected.

\_\_\_\_\_  
Customer Signature

\_\_\_\_\_  
Dealer Signature

\_\_\_\_\_  
Customer Name (please print)

\_\_\_\_\_  
Dealer Name (please print)

\_\_\_\_\_  
Dealer Purchase Order Number

# Schrock™

Dear Schrock Customer,

Congratulations on your selection of Schrock cabinetry in Rustic Alder. Because of its unique characteristics Rustic Alder is quite different from other wood types you may be familiar with. Your satisfaction is important to Schrock, and we want you to fully understand the characteristics that make Rustic Alder so distinctive.

It is important to realize that the beauty of wood cabinetry comes from the natural qualities of wood itself. Rustic Alder is characterized by its light brown and reddish undertones and may contain a variety of pin holes, open and closed knots of various sizes and colors, small cracks, bird pecks, mineral streaks, and grain variation. Some knots may have small holes through the panel. Larger holes will not be filled. In addition, the wood will contain color difference caused by variations in minerals found in the soil, creating visible mineral tracks. However, those characteristics that might compromise the structural integrity of the door will not be included.

Sound Closed Knot (not moveable) – Expected in Rustic Alder up to approximately 3” diameter.

Sound Knot with Cracks – Expect sound knots with open cracks up to approximately 1” in length.

Open Knot (through door) – Expected in Rustic Alder with open area up to approximately 3/4” diameter.

Note: 3/4” diameter is about the size of a penny. Holes created by open knots pass completely through the door and are desirable for this rustic look.

Unsound Knot (moveable core) – Not to be expected.

Knot Cluster (cluster of tight sound knots) – To be expected in Rustic Alder.

Worm Holes/Pin Holes (can go through door) – Can be expected on Rustic Alder up to approximately 1/4” diameter.

Worm Tracks – Can be expected on Rustic Alder in sizes up to approximately 1/8” wide by 8” long.

Rustic Alder as described is featured for doors, drawer fronts, and selected mouldings. Other areas of the product will utilize standard hard Alder. Customers should expect a much lower occurrence of rustic characteristics in these other areas. Also, the natural characteristics mentioned occur randomly in Rustic Alder. All doors, drawer fronts, and selected mouldings will contain some combination of the common Rustic Alder markings; however, it will be uncommon to find all markings on any single piece.

The natural characteristics of wood described above and variations in grain patterns and color are not considered reasons for product replacement. We mention these characteristics because neither Schrock nor your Schrock dealer can be responsible for these conditions and variations.

Accordingly, we ask that the following agreement be signed for Rustic Alder orders.

---

I have read the foregoing and find the characteristic variations of wood with Rustic Alder are desirable.

As such, I agree not to hold Schrock and/or the Schrock dealer listed below responsible in the event that these characteristics are later found by me to be less desirable than I had expected.

---

Customer Signature

---

Dealer Signature

---

Customer Name (please print)

---

Dealer Name (please print)

---

Dealer Purchase Order Number

# Schrock™

Dear Schrock Customer,

Congratulations on your selection of Schrock cabinetry in Rustic Hickory. Because of its unique characteristics Rustic Hickory is quite different from other wood types you may be familiar with. Your satisfaction is important to Schrock, and we want you to fully understand the characteristics that make Rustic Hickory so distinctive.

Rustic Hickory is a strong, heavy hardwood known for distinctive graining patterns. Color will vary from nearly white to dark brown, with wild, flowing grain patterns and dramatic color variations. Rustic Hickory can have a fine uniform grain to large knots appearing black and brown in color of various shapes and sizes, sapwood, mineral and some checking.

Sound Closed Knot (not moveable) – Expected up to approximately 3” diameter.

Sound Knot with Cracks – Expect sound knots with open cracks up to approximately 1” length.

Open Knot (through door) – Expected with open area up to approximately 3/4” diameter.

Unsound Knot (moveable core) – Not to be expected.

Worm Holes/Pin Holes (can go through the door) – Can be expected up to 1/4” diameter.

Worm Tracks – Can be expected in sizes up to approximately 1/8” wide by 8” long.

Note: 3/4” diameter is about the size of a penny. Holes created by open knots pass completely through the door and are desirable for this rustic look.

Doors, drawer fronts, and selected trim items will feature rustic characteristics. Other areas of the product will utilize standard Hickory.

The natural characteristics of wood described above and variations in grain patterns and color are not considered reasons for product replacement. We mention these characteristics because neither Schrock nor your Schrock dealer can be responsible for these conditions and variations.

Accordingly, we ask that the following agreement be signed for Rustic Hickory orders.

---

I have read the foregoing and find the characteristic variations of wood with Rustic Hickory are desirable.

As such, I agree not to hold Schrock and/or the Schrock dealer listed below responsible in the event that these characteristics are later found by me to be less desirable than I had expected.

---

Customer Signature

---

Dealer Signature

---

Customer Name (please print)

---

Dealer Name (please print)

---

Dealer Purchase Order Number

Code	Page Number
1TWT	444
2DB	306
2DB..DR	310
2DB..FD	306
2DB..PDO	308
2DB..RT	308
2DB..RTPDO	308
2DB..WD	310
3CDB	304
3DB	310, 340, 438
3DB..KCUP	312
3DB..WD	312
3DB..WTCD	312
3DBB	310
3DBBDD	314
3DBDD	314
3TWT	446
4DB	314
4DB..CIW	316
4DB..KCUP	316
4DB..WTCD	316
4TWT	448
4VDB	472
ABFOOT	560
ACAM	543
ACO	552
ACOVLY	552
ACS	50, 284
ACSF	284
ACSFb	286
ADDTK	56
ALF	61
ANGLHEATSHIELD	581
ANGLHSHIELDSS	581
APC	41
AUTHL, AUTHR	45
AV	551
B	234-236, 338
B..CIA	306
B..COA	304
B..CIW	236
B..CWP	268
B..DR	328
B..FH	240, 244
B..FHMIXSC	270
B..FHRT	258
B..FHRTLO	264
B..FSCO	266
B..KCUP	240
B..KCUPRT	264
B..PS	264
B..RT	256
B..RTCW	260
B..RTLO	264
B..RTWTC	262
B..TDRO	270
B..WTCD	238
BATTLI	571
BBCPO	326
BBM	546
BBMSH	546
BBMSW	547
BBMWD	330
BBTP	320
BC	292
BC..PO	292
BCF	513-518
BCFW	292
BCFW..CPO	294
BCFW..FH	294
BCFW..PO	294
BCFW..SP	294
BCOPP	324
BCP	334
BCP..FH	334
BEAS	246
BEC	306

Code	Page Number
BED	529
BEP	522
BEP..AEL, AER	527
BEP..VG	528
BEPP	525
BEPS	519
BER	298
BERAS	298
BFPC	553
BFRC	552
BKSOCKET	588
BLOWER	218
BLS	296
BLS..DR	296
BLSBEP	523
BLVDFF	513
BMC	326
BMW	332
BMW..RT	332
BMW..DD	330, 340
BMW..D	330
BO	328
BOC	336
BOD	336
BP	520
BP..CRSGR	521
BP..VG	521
BPM	543
BPP	324
BPPP	266
BPS	579
BPT	234
BPT..FH	240
BPT..WB	318
BPT..WBFH	318
BQRES	334
BRACKETIND	567
BRAIDM	543
BRDB	302
BRKOFFSCREW	591
BRMCLP	579
BSC3OPR, R, RP, RS, SR	248
BSC36PRP, PRS, SRP, SRS	252
BSCG	250, 254
BSD	322
BTC	304
BTDP	324
BUMPERPADS	591
BUNLEG	553
BUPP	324
BUPPKB	326
BV2SC3OPR, RP, RS, SR	250
BV2SC36PRP, PRS, SRP, SRS	254
BWB	316
BWB..FH	318
BWBFLID, BWBLID	579
BWC	322
CABCLEANKIT	589
CABL	572
CABLRIG	572
CABMAT	579
CABMATV	579
CAPM	548
CBO	47
CCM	544
CCO	47
CD	184
CF	508
CFNTO	60
CFP	47
CFRMO	60
CG, CG..BTM, CG..TOP	62
CIW	580
CLTCROWN	539
CMAT	52
CND	47
CNTYSB	286
CNTYSB..CM	288
CNTYSB..SA	288
CONNFLX	572

Code	Page Number
CONVERSION	220
CORBELART9	563
CORBELBAU	566
CORBELCOVE	563
CORBELMIS6	564
CORBELMIS9	564
CORBELWD5	564
CORBELTRIAD	565
CORBELTRSS	567
COTCROWN	539
COVECROWN	539
CPE	544
CS	284
CTDK	584
CUDD	580
DAB..FS	296
DAB..SLS	296
DADOOR	535
DAPNL	534
DB	306-316
DCM	549
DDFD	440
DDO	436
DER	442
DFD	440
DFFSPC	42
DFFSPCSLBT	43
DFRSPC	42
DFRSPCSLBT	43
DFSLB	42
DFSLBT	43
DGK	588
DIMM	572
DLEMISSION	557
DOOR	537
DOORSLAB	538
DPSRR	44
DRT	53, 586
DRWPWR	54, 582
DRWSEC	52
DRWTK	59
DW	152-154
DW..D	156
DW..DS	156
DW..P	160
DW..S	154
DWB..FH	440
EDGEBAND	581
EGD	543
ENDRIG	572
ENGBARCOLUMN	554
ENGISLCOLUMN	554
ER	162
ES	569
ET	53
EXBKL, EXBKR	49
EXL, EXR	50
EZORG	583
F	508
F..R	508
FALSEPNLCLIP50	588
FB	45
FBF	513
FD	52, 442
FDWB	444
FFDL, FFDR	45
FFP	553
FFRC	552
FIC	322
FICNT	322
FLEX	571
FOLCROWN	539
FOOTMETAL	567
FPEB	45
FS	569
FTK, FTK..FNT.P, FTK.P	56
FTKAV, FTKAV..FNT.P, FTKAV.P	56
FTKfV, FTKfV..FNT.P, FTKfV.P	56
FV	551
GAEULLEG	556

Code	Page Number
GLAZEPEN	589
HINGE	590
HINGEFH	578
HINGERESCLIP	590
HINGESHIM	590
HL	232
HM	230-232
HP..21	226
HPP..21	228
HS	232
ICM	549
ID	48
INSCROWN	539
INSERTCELT	543
INSTALLSCR, INSTALLSCREWS	591
INFRM	51
IR	572
ISLEGTPRD	556
ISLLEG	556
J3SPTRING	562
JBAROQUELEG	553
JBRACKETART	564
JBUFFETLEG	553
JCORBELCOST3	563
JCORBELCOST3D	563
JCORBELCRAFTO	565
JCORBELOWD7	564
JCORBELSHKR	565
JCOSFOOT	560
JCOSMOLEG	554
JCRAFTFOOT	560
JENGCNTYLEG	554
JESTATELEG	555
JESTATELEGS	554
JESTATELEGSS	555
JFLUTELEGS	555
JFLUTELEGS	555
JFRNCNTYLEG	555
JGSK	570
JINSETRLC	548
JINSETRLT	548
JLRINACAN	549
JLRINSCCEL	549
JLRINSMIS	549
JLRINSWEAVE	549
JMADEFOOT	560
JMETROFOOT	560
JPWRPOD	582
JRCPV	551
JROPELEG	557
JRPV	551
JSOC	566
ISPLEGSS	557
ISQBARLEG	558
ISQFOOT	560
ISQFOOTS	561
ISQISLLEG	557
JSRC	566
JURNLEG	559
JWHCA	214
JWHCS	214
JWHL	206
JWHSHIPCH	210
JWHSHIPSTR	208
JWHSHIPSTRCB	208
JWHSHIPT	210
JWHSHIPTCB	210
KCUP	581
KNOB	573
LB	548
LBRM	544
LC	498
LCHAMPERLNR	581
LCRH	498
LEADFLX	572
LEADRIC	572
LGCORBEL	563
LGSQFOOT	560
LIDSTAY, LIDSTAYHD	590
LIFOOT	561



Code	Page Number
LO, LO24DP	581
LOSC	550
LRM	548
LSACROWN	540
LSHAKER	540
LSP	302
LT	498
LTI	53
MC	506
MC16HDW/WCATCH	591
MCFOOTS	561
MD, MD.BTM, MD.TOP	63
MDCCRNHLF	569
MDENTIL	543
MDFLCRNSHLF	569
METBARCOLUMN	556
METISLCOLUMN	556
MFO	44
MIP	46
MIXKITFHSC	579
MSACROWN	540
MTCROWN	540
MTUK	589
MV	496
MW	178
OC135	550
OCD, OCD..DD, OCD..WD, OCD..WDE	398-408
OCINSTALLKIT	582
OCM	550
OCS, OCS..DD, OCS..WD	388-396
OGHEEM	544
OL	509
OL..MFO	509
OMC, OMC..DD, OMC..WD	412-420
OSB	384-386
P	60
PDM	591
PDO, PDOPOSTS	582
PE	41
PFALSEPNCLIP50	588
PFINBTMB	49
PLBLOCK	561
PPP	582
PRMD	65
PTOWB	54
PTU	372
PTUP	374
PTUS	370
PUCK	571
PULL	573
PWT	382
PY	378
Q4ZONECON	572
QDIMREC	572
QRM	550
QUARTCOLOR	589
RD	48
RECTKALL	58
RECTKBK	58
RECTKL	58
RECTKR	58
RESCLIPQR	590
RETCLIP..BAG	591
RIGID	571
ROSETTCELT	553
ROSETTEMIS	552
RPM	543
RT	53, 586
RTBKXSP	588
RVWS	342
S96	509
SACROWN	540
SB	272-276, 338
SB..CDY	272
SB..CM	272
SB..D	282
SB..S	280
SB..SCDY	280

Code	Page Number
SB..SCM	280
SB..ST	276, 338
SB..STCDY	278
SB..STCM	276
SB..STS	280
SB..STSCDY	282
SB..STSCM	282
SBC	290
SBCADDY	582
SBE	545
SBM	545
SBP	545
SBS	564
SCM	541
SCPDRW	44
SFB	284
SFM	542
SHELFBRKTSN	568
SHELFPEGS, SHELFPEGSCTR	591
SHKRCRM	540
SHLFPD	583
SHM	550
SHMD	64
SK	570
SLS	300, 340
SLSCR	300
SLSW	300
SM	544
SMCORBEL	563
SMCOVECROWN	541
SMLR	548
SPACERBLK	588
SPD	583
SPLG	557
SPRINGEND	562
SPRINGREED	562
SPRINGROPE	562
SPRINGSPPOOL	562
SQLEG	558
SQLEGTAP	559
SRCH	583
SSC	589
SSM	545
SSS	298
STAND	571
STBRACKETIND	568
STDW	158
STR	583
STR8	542
STRS	542
STRTHATSHIELD	581
STRTHSHIELDSS	581
STW	136
STWC	148
STWTC	176
SV	551
SWCRM	541
SWLCRM	541
SWTCRM	542
SWVCRM	542
TABLETHLDR	583
TAPLG	561
TB	547
TBC	428-430
TBCD	432-434
TBEM	545
TBMWB	410
TBP	546
TCM	544
TD	55, 270
TD..FH	270
TDKIT	584
TDRO	584
TED	529
TEP, TEP..AEL, TEP..AER	523, 528
TEP..VG	528
TEP	528
TEPS	519
TF	508
TKC	547

Code	Page Number
TKP	58
TKTLFOOT	561
TLFOOT	561
TOEKICKVAC	583
TOT	584
TOTSSS	54, 584
TOUHLATCH	567
TPP	374
TRIBRKT	567
TROSETTE	552
TSTM	545
TUK	589
TV	506
TVHDW/WCATCH	591
TVRAV, TVRFV, TVRVV	51
TWH	218
TWHBLOWER	218
U	344-356
U..RT	358-364
UCD	448, 496
UOC	366
UOCDZ	368
UPM	546
US	376
US..PP	376
V	450-454
VACSF	494
VACSF8	494
VB	464
VBEP	524
VBH	498
VBWB	472
VCRR	584
VDB	468
VDL	528
VDL..WD	340
VER	466
VFR	548
VGPO	474
VH..FH	496
VM	506
VMP	506
VP	474
VS3D	488
VS8	456-458
VS8.....U	460
VS8.....WB	460
VSD	476-490, 494
VSD..FP	492, 494
VSSB.....ST	460
VSSB.....STWB	460
VTK	59
VU	500
VV	551
VWB	472
VWH	500
VWM	504
VWS	342
VWTB	504
W	90-126, 202, 504
W..BC	422
W..CIA	166
W..COA	166
W..PO	104, 110, 114
W..SHLFPD	192
W..SPD	190
W2D	128, 132
W3D	134
WAGD	184
WAGVLD	184
WAIN	532
WB	244
WBCPO	186
WBCPOKUP	188, 581
WBMW	180
WC	142-146
WCD	198

Code	Page Number
WCT	547
WEAS	128
WEC	168
WED	530
WEP..VG	528
WEP	528
WEPS	520
WFBC	424
WGH	585
WHA	204
WHAFP	206
WHC	206
WHCA	210
WHCS	214
WHS	204
WHSBATTEN	216
WHSFP	206
WHSMC	212
WHSMT	212
WHSMTCB	212
WLI	46
WMC	204
WMF	544
WNR	200
WO	202
WOC	194-196
WQRES	170-172
WSC	200
WSCRIBE	546
WSD	202
WSK	585
WSP	190
WSR	192
WTC	174
WTCO	580
WTH	88-108
WTHRESCLIP	590
WVL	102-110

## NOTES

## NOTES

## NOTES



## OUR COMMITMENT TO CHANNEL PARTNERS, DESIGNERS AND CUSTOMERS

Schrock's Express Response™ program is designed to expedite orders when customers need product faster than normal lead times to correct problems with an existing order.

Below is an overview of the program and what you can expect from Schrock's commitment to superior service.

### GUIDELINES

- Order must be associated with a previous order number.
- All orders received by 12 NOON E.T. Monday-Friday will be automatically scheduled for Express Response that same day. Orders received after the cutoff time will be processed on the next business day.
- Lead time calculation is based on receipt of a clean order on a credit-worthy account. Clean orders are orders in which all information is provided and accurate.
- There is no additional up-charge for Express Response.
- There are no cancellations or returns once order is received.
- Due to the special nature of Special Orders and Appliance Panels, they are excluded from the Express Response program and will be processed as a standard lead time order.
- Express Response is available within the continental United States. Should Alaska, Hawaii or international shipments be required, customer service representatives are ready to assist by providing shipping information and determining lead times.

### LEAD TIMES

**12 WORKING DAYS OR LESS FROM ORDER TO DELIVERY** (channel partner or home delivery agent):

- Items shipped via LTL (via SuperPAC™) or truckload.
- Includes all catalog items except those that can be expedited through the 5-day program listed below.

**5 WORKING DAYS FROM ORDER TO DELIVERY:**

- Qualified items are designated in the Pricing/Specification Guide with an icon
- Items will ship via parcel ground.
  - o Lead time calculation allows for 2 days parcel ground shipping time. Some geographic areas may require additional shipping time.
- For orders containing both 12 day and 5 day items, the longer lead time applies.















QUESTIONS? If you have questions that aren't answered here,  
contact your Customer Service team.

PREMIUM COLOR PALETTE							
	OPTION NAME	DESCRIPTION/ LIMITATIONS	MATCHING LAMINATE ENDS <sup>▲</sup>	UPCHARGE**	DISTRESSING AVAILABILITY	HEIRLOOMING AVAILABILITY	MATTE SHEEN AVAILABILITY
Paints*	Juniper Berry	Pale antique blue	N/A	7% or 15%	✓	✓	N/A
Paints with Glazes*	Juniper Berry w/Tidal Mist	A two tone finish, applying a pale antique blue paint finish enhanced with a light brown glaze.	N/A	15%	✓	✓	N/A

▲In Trademark construction, cabinets will have matching laminate ends. Where not available, ends will be Natural Maple laminate and a finished end treatment would be needed for an exposed end.

\*On wood products, normal movement is typical due to change in climatic conditions. This will cause hairline cracks at stile, rail and panel joints. This hairline cracking is a normal characteristic of painted finishes and will not be considered a reason for product replacement. Finish agreement required, see page 602 of the Pricing and Specifications Guide.

\*\*Cabinet list includes cabinet price plus any modifications except APC, ET, and PE.

FINISH AVAILABILITY																																						
					MAPLE																																	
		Matching Laminate Ends <sup>▲</sup>	Upcharge	Heirlooming* 	Matte Sheen	Ainsley	Asbury	Banbury	Brantley	Brinkman	Campbell	Carmin	Denton	Edmond	Elston	Fletcher	Galena	Galvyn 	Harwell 	Huxley	Ingalls 	Jarret	Kayes 	Kennedy	Lainey 	Lormand 	Morgan	Natcher 	Parker	Patmore	Pleasant Hill	Prestley 	Rivali 	Seaton	Whittaker	Willet 		
Paints 	Juniper Berry		15%	5%		✓	✓	✓	✓	✓	✓	✓	✓	✓	✓	✓	✓	✓	✓	✓	✓	✓	✓	✓	✓	✓	✓	✓	✓	✓	✓	✓	✓	✓	✓	✓	✓	✓
Paints with Glazes 	Juniper Berry w/Tidal Mist		15%	5%		✓	✓	✓	✓	✓	✓	✓	✓	✓	✓	✓	✓	✓	✓	✓	✓	✓	✓	✓	✓	✓	✓	✓	✓	✓	✓	✓	✓	✓	✓	✓	✓	✓

\*Heirlooming upcharge is in addition to other finish upcharges. Heirlooming not available on Carmin, Harwell, Prestley, and Rivali.

▲In Trademark construction, cabinets will have matching laminate ends. Where not available, ends will be Natural Maple laminate and a finished end treatment would be needed for an exposed end.

 Signed finish agreement required, see pages 601-604 of the Pricing and Specifications Guide.

				MDF			
		Matching Laminate Ends <sup>▲</sup>	Upcharge	Denton	Elston	Pleasant Hill	Prestley
Paints 	Juniper Berry		7%	✓	✓	✓	✓

▲In Trademark construction, cabinets will have matching laminate ends. Where not available, ends will be Natural Maple laminate and a finished end treatment would be needed for an exposed end.

 Signed finish agreement required, see pages 601-604 of the Pricing and Specifications Guide.







**Price Point Order**

1 Galvyn Oak ◇	10 Elston Maple
2 Galvyn Maple ◇	10 Elston MDF
2 Lormand Oak ◇	10 Elston Rustic Alder
3 Harwell Oak ◇	10 Elston Rustic Hickory
3 Lormand Alder ◇	10 Parker Maple
3 Lormand Maple ◇	10 Rivali Cherry ◇
3 Lormand Rustic Alder ◇	10 Seaton Maple
3 Lormand Rustic Hickory ◇	10 Whittaker Maple
4 Harwell Maple ◇	11 Brinkman Cherry
4 Kayes Maple ◇	11 Carmin Cherry
4 Morgan Alder	11 Willet Cherry ◇
4 Morgan Maple	12 Denton Maple
4 Morgan Rustic Alder	12 Denton MDF
4 Morgan Rustic Hickory	12 Huxley Oak
4 Patmore Oak	12 Jarret Maple
5 Fletcher Maple	12 Kennedy Maple
5 Ingalis Oak ◇	12 Pleasant Hill Cherry
5 Patmore Maple	13 Ainsley Maple
6 Brinkman Oak	13 Edmond Cherry
6 Galvyn Cherry ◇	13 Parker Cherry
6 Ingalis Alder ◇	13 Whittaker Cherry
6 Ingalis Maple ◇	14 Elston Cherry
6 Ingalis Rustic Alder ◇	14 Lainey Maple ◇
6 Ingalis Rustic Hickory ◇	14 Prestley Maple
6 Natcher Maple ◇	14 Prestley MDF
7 Harwell Cherry ◇	14 Seaton Cherry
7 Kayes Cherry ◇	15 Banbury Maple
7 Morgan Cherry	15 Denton Cherry
7 Rivali Maple ◇	15 Galena Alder
7 Willet Oak ◇	15 Galena Maple
8 Brinkman Alder	15 Huxley Alder
8 Brinkman Maple	15 Huxley Maple
8 Brinkman Rustic Alder	15 Huxley Rustic Alder
8 Brinkman Rustic Hickory	15 Huxley Rustic Hickory
8 Carmin Maple	15 Jarret Cherry
8 Elston Oak	16 Aspen Laminate
8 Fletcher Cherry	16 Banbury Cherry
8 Patmore Cherry	16 Campbell Maple
8 Willet Maple ◇	16 Campbell Rustic Hickory ◇
8 Willet Rustic Hickory ◇	16 Derazi Laminate
9 Edmond Oak	16 Gallio Laminate
9 Natcher Cherry ◇	16 Herra PureStyle
9 Pleasant Hill Alder	16 Kennedy Cherry
9 Pleasant Hill Maple	16 Lainey Cherry ◇
9 Pleasant Hill MDF	16 Prestley Cherry
9 Pleasant Hill Rustic Alder	17 Asbury Maple
9 Pleasant Hill Rustic Hickory	17 Brantley Maple
10 Chanley Alder	17 Galena Cherry
10 Chanley Rustic Alder	17 Huxley Cherry
10 Edmond Maple	18 Asbury Cherry
10 Edmond Rustic Hickory ◇	18 Brantley Cherry
10 Elston Alder	18 Campbell Cherry

**Alphabetical Order**

13 Ainsley Maple	12 Huxley Oak
18 Asbury Cherry	15 Huxley Rustic Alder
17 Asbury Maple	15 Huxley Rustic Hickory
16 Aspen Laminate	6 Ingalis Alder ◇
16 Banbury Cherry	6 Ingalis Maple ◇
15 Banbury Maple	5 Ingalis Oak ◇
18 Brantley Cherry	6 Ingalis Rustic Alder ◇
17 Brantley Maple	6 Ingalis Rustic Hickory ◇
8 Brinkman Alder	15 Jarret Cherry
11 Brinkman Cherry	12 Jarret Maple
8 Brinkman Maple	7 Kayes Cherry ◇
6 Brinkman Oak	4 Kayes Maple ◇
8 Brinkman Rustic Alder	16 Kennedy Cherry
8 Brinkman Rustic Hickory	12 Kennedy Maple
18 Campbell Cherry	16 Lainey Cherry ◇
16 Campbell Maple	14 Lainey Maple ◇
16 Campbell Rustic Hickory ◇	3 Lormand Alder ◇
11 Carmin Cherry	3 Lormand Maple ◇
8 Carmin Maple	2 Lormand Oak ◇
10 Chanley Alder	3 Lormand Rustic Alder ◇
10 Chanley Rustic Alder	3 Lormand Rustic Hickory ◇
15 Denton Cherry	4 Morgan Alder
12 Denton Maple	7 Morgan Cherry
12 Denton MDF	4 Morgan Maple
16 Derazi Laminate	4 Morgan Rustic Alder
13 Edmond Cherry	4 Morgan Rustic Hickory
10 Edmond Maple	9 Natcher Cherry ◇
9 Edmond Oak	6 Natcher Maple ◇
10 Edmond Rustic Hickory ◇	13 Parker Cherry
10 Elston Alder	10 Parker Maple
14 Elston Cherry	8 Patmore Cherry
10 Elston Maple	5 Patmore Maple
10 Elston MDF	4 Patmore Oak
8 Elston Oak	9 Pleasant Hill Alder
10 Elston Rustic Alder	12 Pleasant Hill Cherry
10 Elston Rustic Hickory	9 Pleasant Hill Maple
8 Fletcher Cherry	9 Pleasant Hill MDF
5 Fletcher Maple	9 Pleasant Hill Rustic Alder
15 Galena Alder	9 Pleasant Hill Rustic Hickory
17 Galena Cherry	16 Prestley Cherry
15 Galena Maple	14 Prestley Maple
16 Gallio Laminate	14 Prestley MDF
6 Galvyn Cherry ◇	10 Rivali Cherry ◇
2 Galvyn Maple ◇	7 Rivali Maple ◇
1 Galvyn Oak ◇	14 Seaton Cherry
7 Harwell Cherry ◇	10 Seaton Maple
4 Harwell Maple ◇	13 Whittaker Cherry
3 Harwell Oak ◇	10 Whittaker Maple
16 Herra PureStyle	11 Willet Cherry ◇
15 Huxley Alder	8 Willet Maple ◇
17 Huxley Cherry	7 Willet Oak ◇
15 Huxley Maple	8 Willet Rustic Hickory ◇

# Schrock™

*Uniquely yours.™*

Styles, product availability and construction may vary slightly from those shown in this book due to material availability and/or design evolution. Specifications are subject to change without notice. Customer service is available if your design requires verification of product availability and specifications.

Product photography and illustrations have been reproduced as accurately as printing technologies permit. To ensure highest satisfaction, we strongly recommend you view an actual sample for best color, wood grain and finish representation.

### Schrock™ has a Limited Lifetime Warranty.

For terms and conditions, please visit: <https://www.schrock.com/warranty>

**Front cover image:** HERRA PureStyle™ Elk & PRESTLEY Maple Black Paint **Back cover flip-out image:** PLEASANT HILL Maple Egret Paint

### Customer Service

Hours: Mon - Fri, 7:30 AM - 8:00 PM EST

Phone: (800) 730-0171 Fax: (877) 333-7122

Please reference Service Policies at [www.mbcitouch.com](http://www.mbcitouch.com)

Designer ID #: \_\_\_\_\_

Customer Account #: \_\_\_\_\_

Sales Rep: \_\_\_\_\_



**National Forest  
Foundation**



**Part of the  
MasterBrand™  
Family**

**[schrock.com](http://schrock.com)**

**#SchrockCabinets**

© 2020 MasterBrand Cabinets, Inc. All rights reserved.

1151009950  
2020-03/CNV/2.6M