

URBAN EFFECTS[®]

CABINETS



See the details. Get the look.

Love your kitchen and bath.

Every style. Every color. It's right here.



Yorkshire door style in Maple finished in Mystic Grey



TREAD LIGHTLY

Achieve beauty that is environmentally sound with Bamboo and Echo Wood, a responsible alternative to rare woods.

Bamboo..... 19
 Echo Wood 18-19

ENGINEERED

Choose from precision-made material to create cabinetry that is perfect for your uncompromising, cosmopolitan style.

Thermofoil..... 20
 PureStyle™ 21
 Melamine..... 22-23
 Metal Accents 24
 Acrylic 25

HARMONIOUS

Explore our opaque choices when you want a solid, painted look that is durable and long lasting.

Maple 32-33
 High Density Fiberboard (HDF)..... 32-33
 Brush Stroke 34
 Oak..... 35
 Rift Oak..... 35

ESSENCE

Only Nature gives us warm, inviting material from which we can craft cabinetry with unique personality.

Wood Door Styles..... 26-28
 Cherry Color Choices 36-37
 Maple Color Choices 40-41
 Oak Color Choices 42-43
 Rift Oak Color Choices 44-45
 Rustic Alder Color Choices..... 38-39
 Walnut Color Choices..... 38

FIND YOURSELF IN OUR CABINETRY

Discover five piece drawer headers, glass front doors, mullion doors and custom colors. 29, 46-47





Cottonwood door style in HDF finished in Bright White. Accented with the Aura door style in Melamine in Strata.



kitchen choices



Redan door style in HDF finished in Cloud White.



kitchen choices



Highland Horizontal door style in Echo Wood Oak finished in Sand and the Lucent door style in Acrylic in Gloss White. Accented with HDF finished in a custom color called Summer Breeze.



Highland Horizontal door style in Echo Wood Maple finished in Molasses



Highland Horizontal door style in Echo Wood Oak finished in Hazelnut





Cottonwood door style in HDF finished in Black Bean



Aura Horizontal door style in Melamine in Strata

bath choices

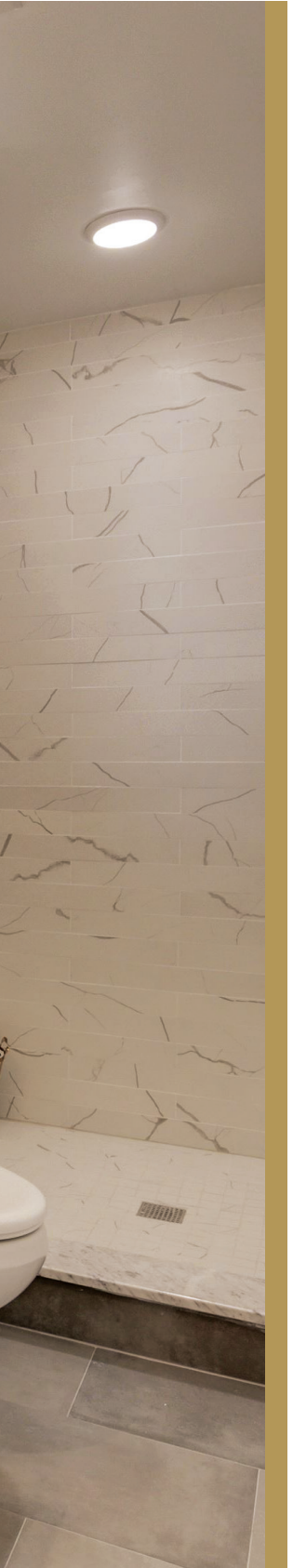

Cottonwood door style in HDF finished in Artistic White.



Iron Shore door style in Maple finished in Smoke.





The design flexibility of Urban Effects Cabinetry allows you to keep even the hardest working room in your home beautiful and functional.

Cascade door style in Thermofoil in Cascade Dark.



other roomchoices



Cottonwood door style in HDF finished in Graphite.

ECHO WOOD COLORS

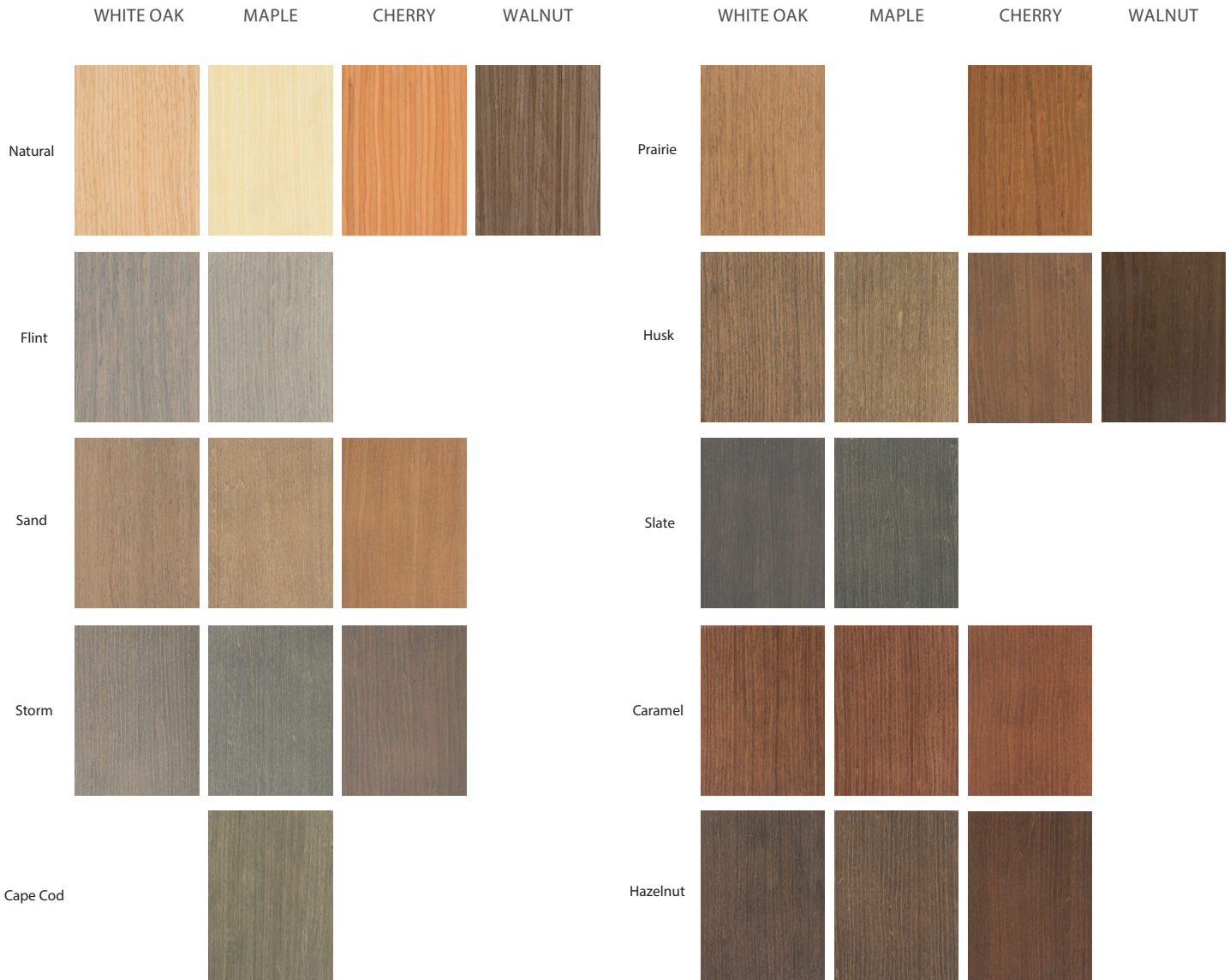

ECHO WOOD DOOR STYLES



HIGHLAND
Shown here in Echo Wood
Cherry finished in Natural
Standard drawer header Slab
Available options ID

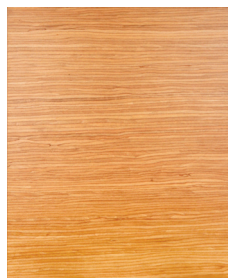

HIGHLAND HORIZONTAL
Shown here in Echo Wood
Cherry finished in Natural
Standard drawer header Slab
Available options ID



OPTIONS
Illustrated on page 46-47
R Routed Drawer Header
M Mullions
ID Center panel of door is
removed and prepared to
accept insert

Our Highland door and Highland Horizontal door are available in Echo Wood, a reconstituted wood product.

Echo Wood mimics the look of White Oak, Maple, Wenge, Walnut and Cherry wood. The look of Shale rock is also available in Echo Wood.

Echo Wood wood fiber comes from forests that are well managed, plantation-grown and Forest Stewardship Council Certified. Echo Wood is a beautiful and practical alternative to achieving the look of the most expensive and rare woods, preserving them for future generations. Echo Wood is free of defects and consistent in color and grain time and time again.

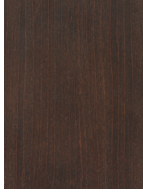
A Gentle Take on Nature

	WHITE OAK	MAPLE	CHERRY
Chocolate			
Molasses			
French Roast			
Weatherstone			
Java			
Smoke			
	SHALE	WENGE	
			



Highland Horizontal door style in Echo Wood Oak finished in Natural



BAMBOO

Bamboo is a unique look for your kitchen and bath. Bamboo is not a tree, it's a grass. Like your lawn, as soon as Bamboo is cut, it starts to grow back. Harvesting bamboo to make cabinets does not injure the surrounding environment, and bamboo's extensive root system holds soil in place. It's a great look that's green! The Highland door and Highland Horizontal door (shown above) are available in Bamboo.

THERMOFOIL DOOR STYLES



ASHBURN
Price Column 1
Shown here in Textured White
Available colors Bisque, Natural, Textured White, Smoke
Standard drawer header Slab
Available options ID



BELVIEW
Price Column 2
Shown here in White
Available colors Bisque, Natural, White, Smoke
Standard drawer header Slab
Available options R, M, ID



CANTUM
Price Column 1
Shown here in Cascade White
Available colors, standard and horizontal Cascade Dark, Cascade Grey, Cascade White
Standard drawer header Slab
Available options ID



JASPER
Price Column 3
Shown here in Bisque
Available colors Bisque, Natural, White, Smoke
Standard drawer header Slab
Available options R, M, ID

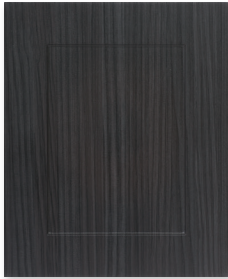

MISSION
Price Column 2
Shown here in Cascade Dark
Available colors, standard and horizontal Cascade Dark, Cascade Grey, Cascade White
Standard drawer header Slab
Available options R, M, ID



MOUNTAINVIEW
Price Column 1
Shown here in Textured White
Available colors Bisque, Natural, Textured White, Smoke
Standard drawer header R



OLD CASTLE
Price Column 2
Shown here in White
Available colors Bisque, Natural, White, Smoke
Standard drawer header Slab
Available options M, ID

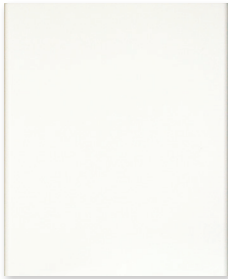

SOHO
Price Column 1
Shown here in Textured White
Available colors Bisque, Natural, Textured White, Smoke
Standard drawer header Slab
Available options ID



VALLEYVIEW
Price Column 4
Shown here in White
Available colors Bisque, Natural, White, Smoke
Standard drawer header Slab
Available options R, M, ID



WINDSOR
Price Column 1
Shown here in Textured White
Available colors Bisque, Natural, Textured White, Smoke
Standard drawer header R
Available options M, ID

- Options illustrated on page 46–47
- R Routed Drawer Header
 - M Mullions
 - ID Center panel of door is removed and prepared to accept insert

THERMOFOIL COLORS

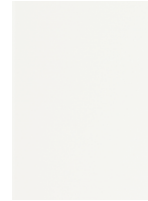

Textured White

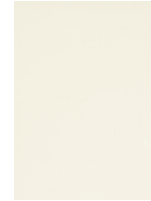

White



Bisque



Cascade White



Cascade White Horizontal



Natural



Cascade Grey



Cascade Grey Horizontal



Cascade Dark

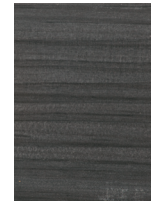

Cascade Dark Horizontal

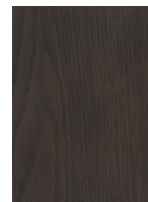

Smoke

Thermofoil is a man-made material that designers love to use for furniture and cabinetry. Thermofoil is also known as 3D laminate. It wraps around a sturdy substrate of engineered wood and provides instant good looks with no seams. Thermofoil doors are easy to clean, oh so durable and offer subtle texture for today's kitchen and bath designs.

INTRODUCING: PURESTYLE™

PureStyle doors feature a true 5-piece mitred construction that gives the authentic look and durability of a real wood door. The rails and center panel of the doors are individually wrapped in a resilient laminate material before the door is built.

Once assembled, the result is a quality product that provides a surface that is abrasion resistant to dents and scratches.

PureStyle™
the look and
feel of wood,
with the
durability of
a laminate.

PURESTYLE™ DOOR STYLES



JOLIETTE
Price Column 3
Shown here in Neptune
Available colors Mink, Neptune,
Sterling
Standard drawer header slab
Available options 5 pc



NOBLE
Price Column 3
Shown here in Mink
Available colors Mink, Neptune,
Sterling
Standard drawer header slab
Available options 5 pc

PURESTYLE™ COLORS



Neptune



Mink



Sterling



Portage



Stardust

Noble door style in PureStyle™ in Sterling

MELAMINE COLORS



Aura door style in Melamine in Neptune

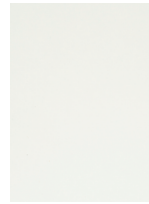

White



Bisque



Baltic
Available only on Rio



Natural



Chill



Sterling



Strata



Flint



Haze



Neptune



Barnwood



Mink



Tempest



Portage



Bulrush



Stardust

MELAMINE DOOR STYLES



AURA
Price Column 2
Shown here in Haze
Available colors Barnwood, Chill, Haze, Strata, Tempest, Vintage, Mink, Neptune, Sterling
Standard drawer header Slab
Available options ID



AURA HORIZONTAL
Price Column 2
Shown here in Haze
Available colors Barnwood, Chill, Haze, Strata, Tempest, Vintage, Mink, Neptune, Sterling
Standard drawer header Slab
Available options ID



MYSTIQUE
Price Column 3
Shown here in Barnwood
Available colors Barnwood, Chill, Haze, Strata, Tempest, Vintage, Mink, Neptune, Sterling
Standard drawer header Three piece drawer header
Available options ID



RIO
Price Column 1
Shown here in Bisque
Available colors Bisque, Flint, French Roast, Natural, Slate, Smoke, White, Baltic
Standard drawer header Slab

Options illustrated on page 46–47
ID Center panel of door is removed and prepared to accept insert

Engineered
to be durable

Designed
to be pretty

Melamine
does it all

NEW! Mystique door style in Melamine in Barnwood

METAL DOOR STYLES



Aluminum Brushed
Stainless



Aluminum Anodized
Natural

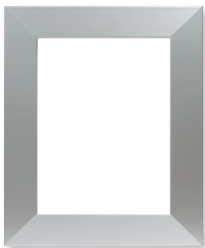

Foil Wrapped No Insert



Canongate door style in Maple finished in Mystic Grey. Accented with Foil Wrapped insert doors inserted with glass.



St. Charles door style in Walnut finished in Husk.

ACRYLIC COLORS

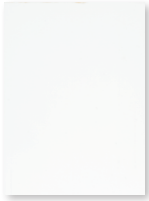

Gloss White



Beige

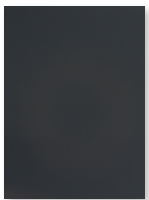

Dark Grey

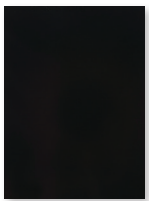

Gloss Black

ACRYLIC DOOR STYLE



LUCENT

Shown here in Gloss White
Price Column 6
Standard drawer header Slab
Available options ID
(illustrated on page 47)



Sleek and smooth

Lucent door style in Acrylic in Gloss White

RECESSED CENTER PANEL



ALBANY
Available wood types
HDF 3, RO 6, W 8, C 5, MA 4,
RA 3, O 3
Standard drawer header Slab
Available options 5, M, ID



AUBURN
Available wood types
C 7, MA 6, O 5
Standard drawer header 5
Available options ID



BROADMOOR
Available wood types
HDF 4, W 8, C 6, MA 5,
RA 4, O 4
Standard drawer header Slab
Available options 5, M, ID



CHESTERMERE
Available wood types
HDF 1, W 8, C 3, MA 2,
RA 2, O 1
Standard drawer header Slab
Available options 5, M, ID



DEERHURST
Available wood types
HDF 4, RO 6, W 8, C 6, MA 5,
O 4
Standard drawer header Slab
Available options 5, M, ID



ELMHURST
Available wood types
HDF 2, RO 5, W 8, C 4, MA 3,
O 2
Standard drawer header Slab
Available options 5, M, ID



FOXFIRE
Available wood types
HDF 4, W 8, C 6, MA 5, RA 4,
O 4
Standard drawer header Slab
Available options 5, M, ID



GLENDALE
Available wood types
HDF 1, W 8, C 3, MA 2, RA 2,
O 1
Standard drawer header Slab
Available options 5, M, ID



HILTON
Available wood types
C 6, MA 6, RA 5, O 5
Standard drawer header 5
Available options M, ID



IRONSHORE
Available wood types
HDF 4, RO 6, W 8, C 6, MA 5,
RA 4, O 4
Standard drawer header Slab
Available options 5, M, ID



KINGSWOOD
Available wood types
HDF 4, RO 6, W 8, C 6, MA 5,
RA 4, O 4
Standard drawer header Slab
Available options 5, M, ID



MUIRFIELD
Available wood types
HDF 4, W 8, C 6, MA 5,
RA 4, O 4
Standard drawer header Slab
Available options 5, M, ID



OXFORDSHIRE
Available wood types
HDF 1, W 8, C 3, MA 2, RA 2,
O 1
Standard drawer header Slab
Available options 5, M, ID



PIONEER
Available wood types
HDF 1, W 8, C 3, MA 2, RA 2,
O 1
Standard drawer header Slab
Available options 5, M, ID



QUEENSTOWN
Available wood types
HDF 5, RO 7, W 8, C 7, MA 6,
RA 5, O 5
Standard drawer header Slab
Available options 5, M, ID



REDAN
Available wood types
HDF 3, RO 4, C 5, MA 4,
RA 3, O 3
Standard drawer header Slab
Available options 5, M, ID



RICHMOND
Available wood types
HDF 3, RO 4, C 5, MA 4,
RA 3, O 3
Standard drawer header Slab
Available options 5, M, ID



SADDLEBROOK
Available wood types
HDF 5, RO 7, W 8, C 7, MA 6,
RA 5, O 5
Standard drawer header Slab
Available options 5, M, ID



SUSSEX
Available wood types
HDF 4, RO 7, W 8, C 6, MA 5,
RA 4, O 4
Standard drawer header Slab
Available options 5, M, ID



VALHALLA
Available wood types
C 6, MA 6,
Standard drawer header 5
Available options M, ID



WINDANCE
Available wood types
C 6, MA 6,
Standard drawer header Slab
Available options 5, M, ID

wood door style choices

FURNITURE LIKE



BRIDGEMILL
Available wood types
C 7, MA 7
Standard drawer header Slab
Available options 5, M, ID



MONACCO
Available wood types
C 7, MA 7, RA 6, O 6
Standard drawer header 5
Available options M, ID



SCOTSWOOD
Available wood types
C 7, MA 7, RA 6, O 6
Standard drawer header 5
Available options M, ID



SHADOWWOOD
Available wood types
C 6, MA 6, RA 5, O 5
Standard drawer header 5
Available options M, ID



Scotswood door style in Oak finished in Storm with Coffee glaze

WOOD TYPES

- C Cherry Available colors shown on pages 36–37
- RA Rustic Alder Available colors shown on page 38–39
- HDF High Density Fiberboard Available colors shown on pages 32–33, 34
- MA Maple Available colors shown on page 32–33, 34, 40–41
- O Oak Available colors shown on pages 35, 42–43
- RO Rift Oak Available colors shown on pages 35, 44–45
- W Walnut Available colors shown on page 38

OPTIONS Illustrated on page 46–47

- 5 Five Piece Drawer Header
- M Mullions
- ID Center panel of door is removed and prepared to accept insert

wood door style choices

SLAB



CANONGATE
Available wood types
C 3, MA 2, RA 2, O 1
Standard drawer header Slab



COTTONWOOD
Shown here in Artistic White
HDF 1
Standard drawer header Slab
Available options ID

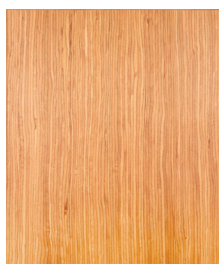

HIGHLAND
Available wood types
HDF 2, Echo Wood 3–5,
Bamboo 5
Standard drawer header Slab
Available options ID

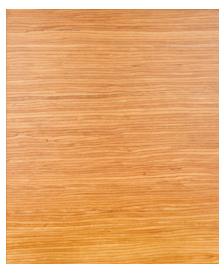

HIGHLAND HORIZONTAL
Available wood types
Echo Wood 4–6, Bamboo 6
Standard drawer header Slab
Available options ID



METRO
Available wood types
RO 4, C 5, MA 4, O 3
Standard drawer header Slab
Available options ID

SHAKER



CANYON
Available wood types
HDF 5, RO 7, W 8, C 7, MA 6,
RA 5, O 5
Standard drawer header Slab
Available options 5, M, ID



DAYTON
Available wood types
HDF 3, RO 4, C 5, MA 4,
RA 3, O 3
Standard drawer header Slab
Available options 5, M, ID



HARBOUR
Available wood types
HDF 4, RO 7, W 8, C 6, MA 5,
RA 4, O 4
Standard drawer header Slab
Available options 5, M, ID



ST CHARLES
Available wood types
HDF 4, RO 6, W 8, C 6, MA 5,
RA 4, O 4
Standard drawer header Slab
Available options 5, M, ID



YORKSHIRE
Available wood types
HDF 1, RO 4, W 8, C 3, MA 2,
RA 2, O 1
Standard drawer header Slab
Available options 5, M, ID

RAISED



COLLINGWOOD
Available wood types
HDF 5, C 7, MA 6, RA 5, O 5
Standard drawer header Slab
Available options 5, M, ID



HERITAGE
Available wood types
HDF 4, C 6, MA 5, RA 4, O 3
Standard drawer header Slab
Available options 5, M, ID



LEGACY
Available wood types
HDF 5, C 7, MA 6, RA 5, O 5
Standard drawer header Slab
Available options 5, M, ID

ARCHED



GLENDALE ARCHED
Available wood types
C 3, MA 2, RA 2, O 1
Standard drawer header Slab
Available options 5, M, ID



HERITAGE ARCHED
Available wood types
C 7, MA 6, RA 5, O 5
Standard drawer header Slab
Available options 5, M, ID

WOOD TYPES

C	Cherry Available colors shown on pages 36–37
RA	Rustic Alder Available colors shown on page 38–39
HDF	High Density Fiberboard Available colors shown on pages 32–33, 34
MA	Maple Available colors shown on page 32–33, 34, 40–41
O	Oak Available colors shown on pages 35, 42–43
RO	Rift Oak Available colors shown on pages 35, 44–45
W	Walnut Available colors shown on page 38

OPTIONS illustrated on page 46–47

5	Five Piece Drawer Header
M	Mullions
ID	Center panel of door is removed and prepared to accept insert

GOOD TO KNOW...

Why choose full access, frameless cabinetry?

As you page through this Selection Guide, you'll see that we offer all the door styles, materials, and cabinet colors you need to create a beautiful kitchen and bath that reflects your style and personality.

Did you also know – when you choose Urban Effects Cabinetry, you are choosing a cabinet style (called full access or frameless) that has more usable space? Compared to framed cabinetry, frameless cabinetry has 15% more storage space.

In addition, compared to framed cabinetry, frameless cabinetry offers:

- Wider drawers – giving you more room for your kitchen gadgets and beauty products.
- Easier access – on wall cabinets that are smaller than 36" wide, no center support is necessary.
- Easier cleaning – cabinets have fewer inside corners.

OUR WARRANTY

Urban Effects Cabinetry is covered by a Limited Lifetime Warranty. For all the details, visit urbaneffectscabinetry.com or talk to your Urban Effects Cabinetry dealer.



We create custom colors!

Did you find a "have-to-have-it" color? Let us know! In addition to our large selection of standard colors, we can create wood cabinetry in a custom color.

More than 10,000 colors are available in our custom library. And if it's not in the library, we are confident we can take your desired hue and create cabinetry in that color. All we need is a paint swatch, paint name or paint code.

Talk to your Urban Effects Cabinetry dealer about cabinetry in a custom color. We want your kitchen and bath to be exactly what you want.

Custom opaque: Maple, HDF, Oak, Rift Oak

Custom stains: All wood species



Broadmoor door style in Maple finished in Mountain Haze



When you want a smooth, consistent painted look in your home, consider Urban Effects Cabinetry's opaque finishes.

Opaque choices for HDF and Maple

				
Bright White	Coffee Glaze	Midnight Glaze	Onyx Glaze	Pewter Glaze
				
Artistic White	Coffee Glaze	Midnight Glaze	Onyx Glaze	Pewter Glaze
				
Mission White	Coffee Glaze	Midnight Glaze	Onyx Glaze	Pewter Glaze
				
Cloud White	Coffee Glaze	Midnight Glaze	Onyx Glaze	Pewter Glaze
				
Fawn	Coffee Glaze	Midnight Glaze	Onyx Glaze	Pewter Glaze
				
Oyster	Coffee Glaze	Midnight Glaze	Onyx Glaze	Pewter Glaze

Opaque finishes are available on Maple, HDF, Oak and Rift Oak door styles shown on pages 26–28. Look for these codes under the doors: MA, HDF, O and RO.

opaque finishes

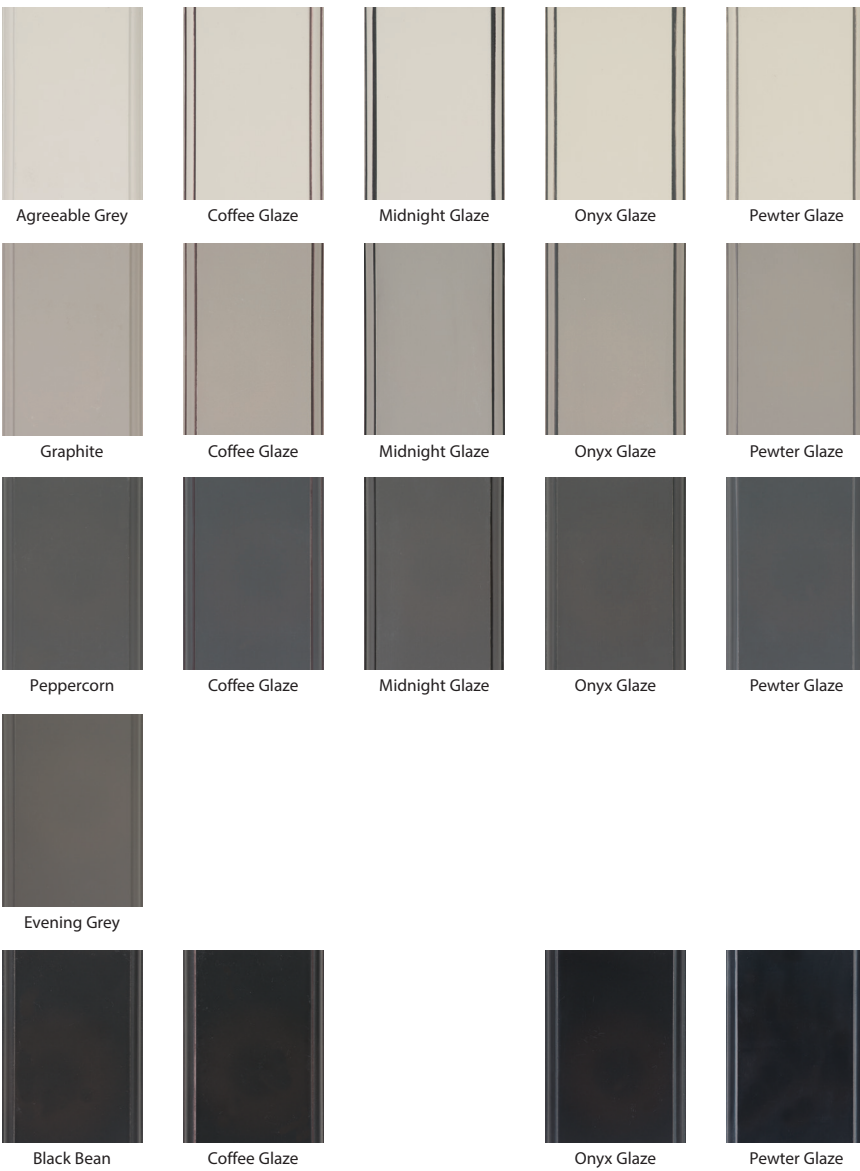

High-density fiberboard (HDF) is an engineered wood product. It is made by breaking down softwood into wood fibers, and combining them with wax and a resin binder. By applying high temperature and pressure, the material is easily shaped into various door styles with pleasing profiles. It is an excellent choice when you want the look of painted cabinets in your home. Opaque finishes will be exceptionally consistent and smooth on HDF material.

Muirfield door style in HDF finished in Agreeable Grey

Brush Stroke opaque with something extra



Collingwood door style in HDF finished in Silver Fox Brush Stroke

We create our Brush Stroke finish by hand!

First, choose a base color from the Brush Stroke palette. We apply the base color, glaze the color, then handcraft a subtle pattern that mimics wood graining. Each cabinet in your design will have slight variation. This variation is what makes this finish so unique, and your kitchen anything but cookie cutter. Rest assured, this is a durable and long lasting color that is finished with an industrial topcoat.

MAPLE

HDF

Silver Fox
Brush Stroke



Mountain Haze
Brush Stroke



Linen
Brush Stroke



Woodgate
Brush Stroke



Meadowood
Brush Stroke























Mystic Grey
Brush Stroke

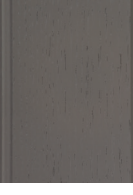

Look for these codes under the doors:
MA and HDF.

OPAQUE CHOICES FOR OAK AND RIFT OAK

	OAK	RIFT OAK		OAK	RIFT OAK
Bright White			Agreeable Grey		
Artistic White			Graphite		
Mission White			Peppercorn		
Cloud White			Evening Grey		
Oyster			Black Bean		
Fawn					

Opaque finishes are available on Maple, HDF, Oak and Rift Oak door styles shown on pages 26–28. Look for these codes under the doors: MA, HDF, O and RO.



Canyon door style in Rift Oak finished in Agreeable Grey

Cherry color choices

Door styles available in Cherry are shown on pages 26–28. Look for "C" under the door.



Natural



Coffee Glaze



Midnight Glaze



Onyx Glaze



Prairie



Coffee Glaze



Midnight Glaze



Onyx Glaze



Monterrey



Coffee Glaze



Midnight Glaze



Onyx Glaze



Sand



Coffee Glaze



Midnight Glaze



Onyx Glaze



Husk



Coffee Glaze



Midnight Glaze



Onyx Glaze



Caramel



Coffee Glaze



Midnight Glaze



Onyx Glaze



Muirfield door style in Cherry finished in Caramel



Storm



Coffee Glaze



Midnight Glaze



Onyx Glaze



Hazelnut



Coffee Glaze



Midnight Glaze



Onyx Glaze



Chocolate



Midnight Glaze



Onyx Glaze



Molasses



French Roast



Java



Broadmoor door style in Cherry finished in Hazelnut

Walnut color choices

Door styles available in Walnut are shown on pages 26–28. Look for “W” under the door.



Natural



Husk



Deerhurst door style in Walnut finished in Husk

RUSTIC ALDER COLOR CHOICES

Door styles available in Rustic Alder are shown on pages 26–28. Look for “RA” under the door.



Natural



Coffee Glaze



Midnight Glaze



Onyx Glaze



Prairie



Coffee Glaze



Midnight Glaze



Onyx Glaze



Monterrey



Coffee Glaze



Midnight Glaze



Onyx Glaze



Sand



Coffee Glaze



Midnight Glaze



Onyx Glaze



Husk



Coffee Glaze



Midnight Glaze



Onyx Glaze



Caramel



Coffee Glaze



Midnight Glaze



Onyx Glaze



Storm



Coffee Glaze



Midnight Glaze



Onyx Glaze



Hazelnut



Coffee Glaze



Midnight Glaze



Onyx Glaze



Chocolate



Midnight Glaze



Onyx Glaze



French Roast



Molasses



Foxfire door style in Rustic Alder finished in Husk with Midnight glaze

Maple color choices



Natural



Coffee Glaze



Midnight Glaze



Onyx Glaze



Flint



Coffee Glaze



Midnight Glaze



Onyx Glaze



Monterrey



Coffee Glaze



Midnight Glaze



Onyx Glaze



Sand



Coffee Glaze



Midnight Glaze



Onyx Glaze



Storm



Coffee Glaze



Midnight Glaze



Onyx Glaze



Husk



Coffee Glaze



Midnight Glaze



Onyx Glaze

Redan door style in Maple finished in French Roast

Maple color choices



Caramel



Coffee Glaze



Midnight Glaze



Onyx Glaze



Weatherstone



Cape Cod



Java



Slate



Coffee Glaze



Midnight Glaze



Onyx Glaze



French Roast



Hazelnut



Coffee Glaze



Midnight Glaze



Onyx Glaze



Molasses



Chocolate



Midnight Glaze



Onyx Glaze



Smoke

Door styles available in Maple are shown on pages 26–28. Look for “MA” under the door.

Oak color choices



Natural



Coffee Glaze



Midnight Glaze



Onyx Glaze



Flint



Coffee Glaze



Midnight Glaze



Onyx Glaze



Prairie



Coffee Glaze



Midnight Glaze



Onyx Glaze



Sand



Coffee Glaze



Midnight Glaze



Onyx Glaze



Husk



Coffee Glaze



Midnight Glaze



Onyx Glaze

Shadowwood door style in Oak finished in Prairie with Midnight glaze

Oak color choices



Storm



Coffee Glaze



Midnight Glaze



Onyx Glaze



Molasses



Caramel

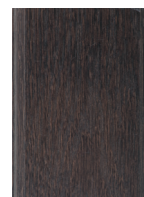

Weatherstone



Slate



Coffee Glaze



Midnight Glaze



Onyx Glaze



French Roast



Hazelnut



Coffee Glaze



Midnight Glaze



Onyx Glaze



Java



Chocolate



Midnight Glaze



Onyx Glaze



Smoke

Door styles available in Oak are shown on pages 26–28. Look for “O” under the door.

Rift Oak color choices



Natural



Coffee Glaze



Midnight Glaze



Onyx Glaze



Flint



Coffee Glaze



Midnight Glaze



Onyx Glaze



Prairie

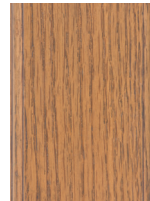

Coffee Glaze



Midnight Glaze



Onyx Glaze



Sand

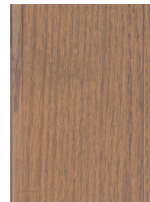

Coffee Glaze



Midnight Glaze



Onyx Glaze



Husk



Coffee Glaze



Midnight Glaze



Onyx Glaze



Storm



Coffee Glaze



Midnight Glaze



Onyx Glaze



Slate



Coffee Glaze



Midnight Glaze



Onyx Glaze



Caramel

Kingswood door style in Rift Oak finished in Weatherstone

Rift Oak color choices



Hazelnut



Coffee Glaze



Midnight Glaze



Onyx Glaze



Chocolate



Midnight Glaze



Onyx Glaze



French Roast



Java



Molasses



Weatherstone



Smoke

Door styles available in Rift Oak are shown on pages 26–28.
Look for "RO" under the door.

DRAWER HEADER STYLE OPTIONS



Muirfield door style in HDF finished in Agreeable Grey

FIVE PIECE

If a door can receive a five piece drawer header, it will have a "5" under the door picture, in "Available options."



Belview door style in Thermofoil in White

ROUTERED

If a door can receive a routed drawer header, it will have a "R" under the door picture, in "Available options."

Cabinetry Construction details

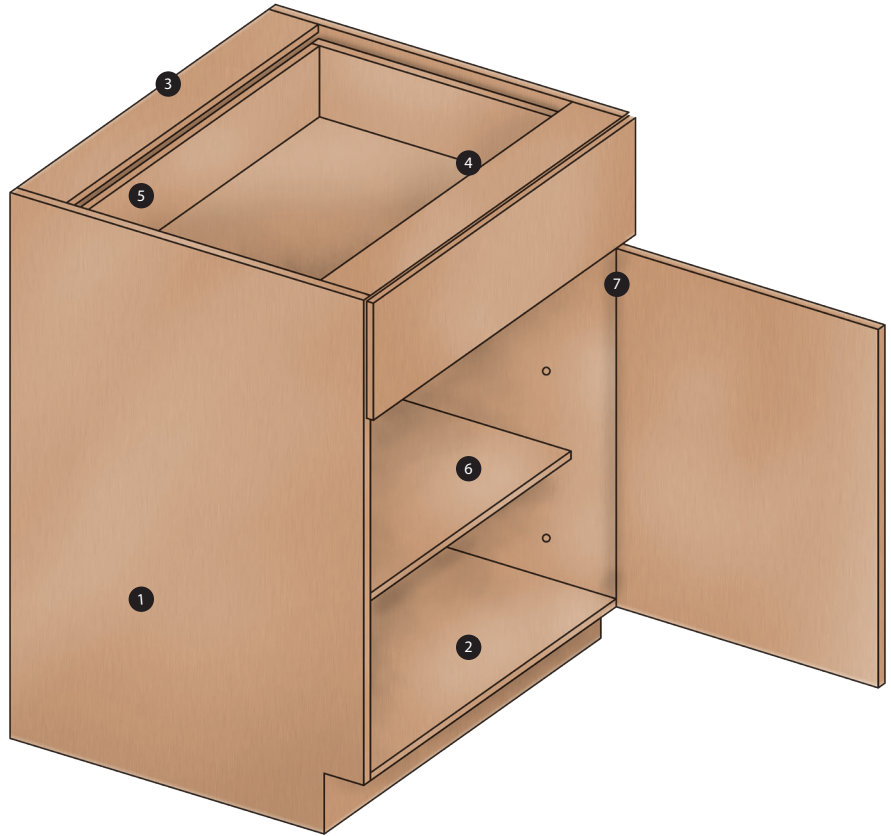

		Construction Specifications	Additional Information
1.	End panels (sides) option option option	5/8" melamine with edge tape Melamine finished ends Veneer finished ends Matching melamine finished ends	White interior only White Interior only
2.	Tops & Bottoms option	5/8" melamine 5/8" plywood	
3.	Back Panel for Wall and Base Back panel for Hanging Vanity	1/4" hardboard 5/8" captured back	
4.	Interior and Drawer Box option option option option option	White interior and double wall steel drawer White interior and wood dovetail drawer box Natural interior and double wall steel drawer Natural interior and wood dovetail drawer box Plywood interior and double wall steel drawer Plywood interior and wood dovetail drawer box Matching interior: stain, opaque or melamine	Includes integrated soft close hinges on doors Includes integrated soft close hinges on doors Includes integrated soft close hinges on doors Includes integrated soft close hinges on doors Includes integrated soft close hinges on doors
5.	Drawers & Slide Out Trays option	5/8" double wall steel 5/8" solid birch with dovetail joints	Soft close, full extension glides, 66 lb load capacity Soft close, full extension glides, 66lb load capacity
6.	Shelves option	5/8" melamine with edge tape 5/8" plywood	
7.	Door hinges option	Adjustable hinges Integrated soft close hinges on doors	Standard with double wall steel drawer box option and wood dovetail drawer box option

At Urban Effects Cabinetry, we craft one kitchen at a time, using the latest CNC technology, in a facility that utilizes energy efficient heating and lighting.

In our 130,000 square foot plant, our manufacturing process keeps your kitchen together from order entry, through finishing and shipping, ensuring accurate quality and on time delivery.

Producing full access cabinets since 2009, we have more than doubled our plant's footprint, while offering the newest trends in color and style. And because we use the latest in European machinery, we respond quickly to changing trends and custom requests.

INTERIORS



WHITE

This is our standard interior. Easy to clean melamine in White provides a bright and clean backdrop for the contents of your cabinets.



NATURAL

This upgrade provides all the benefits of easy to clean melamine with a warmer look.



PLYWOOD

This upgrade outfits your cabinets with beautifully finished plywood interiors.



MATCHING

This upgrade is top of the line. If you have glass front doors or open shelves, you will want the interiors to match the cabinet exteriors. Matching Interiors is available for all stains, all opaques and select melamine colors. Your Urban Effects Cabinetry dealer will have the details.

DRAWER BOXES



DOUBLE WALL STEEL DRAWER

5/8" thick walls
Soft close
Full extension glides
66lb load capacity
Soft close doors are standard with this option



WOOD DOVETAIL DRAWER

5/8" thick walls
Dovetail construction
Soft close
Full extension glides
66lb load capacity
Soft close doors are standard with this option

DOOR STYLE OPTIONS

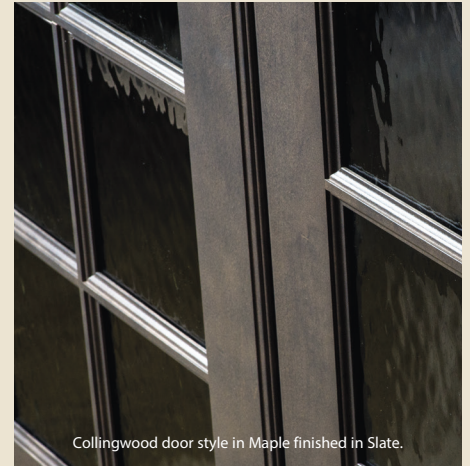

Collingwood door style in Maple finished in Slate.

MULLIONS

If a door can receive mullions, it will have an "M" under the door picture, in "Available options." Please note, glass inserts are not available to order through Urban Effects Cabinetry.



Collingwood door style in HDF finished in Silver Fox Brush Stroke.

INSERT DOORS

If a door's center panel can be removed and prepared to accept an insert, it will have an "ID" under the door picture, in "Available options." Please note, glass inserts are not available to order through Urban Effects Cabinetry.





idea book

URBAN EFFECTS[®] CABINETRY

1980 Springfield Rd
Springfield, MB R5R 0J3, Canada
Toll free number 1-866-998-5298
Fax number 1-204-654-8643
urbaneffectscabinetry.com

This brochure is item #6225 and is called the "Idea Book" brochure.
This brochure was printed in August 2021.
© 2021 Urban Effects Cabinetry

Learn more about Urban Effects Cabinetry:

-  www.facebook.com/UrbanEffectsCabinets
-  www.houzz.com/pro/urbaneffectscabinetry/urban-effects-cabinetry



Urban Effects Cabinetry is EPA TSCA Title VI and CARB II compliant.

The cabinets are certified to the Kitchen Cabinets Manufacturers Association Environmental Stewardship Program (ESP).

For ESP program criteria, visit kcma.org/certifications

This program recognizes cabinet manufacturers who use materials, processes, and practices to reduce the impact on the environment and its customers. Recycling wastes, employing energy conservation measures, and using lower formaldehyde composite wood and non-formaldehyde adhesives are just some examples of how Urban Effects Cabinetry is going beyond minimum requirements.



MADE IN CANADA



Part of the
MasterBrand[™]
Family

Urban Effects Cabinetry is a Norcraft Companies brand. Norcraft Companies is part of the MasterBrand Cabinets Family.

Accuracy of all reprinted color is subject to printing limitations. Please bear in mind that variation is inherent in wood, and actual finishes may differ substantially from what you see here.

As we continually seek to improve materials and production methods, Urban Effects Cabinetry reserves the right to change specifications, offerings or designs without notice.

DESIGN CREDITS

PAGES 4-5, 12, AND BACK COVER

Design and construction by Lock7 Development in Washington DC. The Urban Effects Cabinetry dealer for this project is KBC Direct in Columbia, Maryland.

Your Urban Effects Cabinetry dealer is

SHOWN AT LEFT Cottonwood door style in HDF finished in Bright White. Accented with the Aura door style in Melamine in Strata.

FRONT COVER Cottonwood door style in HDF finished in Black Bean.